

# OWNER'S MANUAL

---

STAGE PIANO

# *CP300*

# *CP300*



# SPECIAL MESSAGE SECTION

**PRODUCT SAFETY MARKINGS:** Yamaha electronic products may have either labels similar to the graphics shown below or molded/stamped facsimiles of these graphics on the enclosure. The explanation of these graphics appears on this page. Please observe all cautions indicated on this page and those indicated in the safety instruction section.

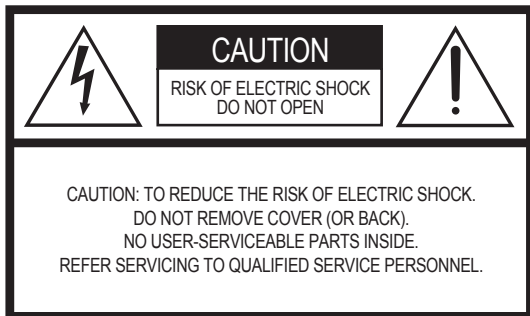

The exclamation point within the equilateral triangle is intended to alert the user to the presence of important operating and maintenance (servicing) instructions in the literature accompanying the product.



The lightning flash with arrowhead symbol, within the equilateral triangle, is intended to alert the user to the presence of uninsulated “dangerous voltage” within the product’s enclosure that may be of sufficient magnitude to constitute a risk of electrical shock.

**IMPORTANT NOTICE:** All Yamaha electronic products are tested and approved by an independent safety testing laboratory in order that you may be sure that when it is properly installed and used in its normal and customary manner, all foreseeable risks have been eliminated. **DO NOT** modify this unit or commission others to do so unless specifically authorized by Yamaha. Product performance and/or safety standards may be diminished. Claims filed under the expressed warranty may be denied if the unit is/has been modified. Implied warranties may also be affected.

**SPECIFICATIONS SUBJECT TO CHANGE:** The information contained in this manual is believed to be correct at the time of printing. However, Yamaha reserves the right to change or modify any of the specifications without notice or obligation to update existing units.

**ENVIRONMENTAL ISSUES:** Yamaha strives to produce products that are both user safe and environmentally friendly. We sincerely believe that our products and the production methods used to produce them, meet these goals. In keeping with both the letter and the spirit of the law, we want you to be aware of the following:

**Battery Notice:** This product **MAY** contain a small non-rechargeable battery which (if applicable) is soldered in place. The average life span of this type of battery is approximately five years. When replacement becomes necessary, contact a qualified service representative to perform the replacement.

**Warning:** Do not attempt to recharge, disassemble, or incinerate this type of battery. Keep all batteries away from children. Dispose of used batteries promptly and as regulated by applicable laws. Note: In some areas, the servicer is required by law to return the defective parts. However, you do have the option of having the servicer dispose of these parts for you.

**Disposal Notice:** Should this product become damaged beyond repair, or for some reason its useful life is considered to be at an end, please observe all local, state, and federal regulations that relate to the disposal of products that contain lead, batteries, plastics, etc.

**NOTICE:** Service charges incurred due to lack of knowledge relating to how a function or effect works (when the unit is operating as designed) are not covered by the manufacturer’s warranty, and are therefore the owners responsibility. Please study this manual carefully and consult your dealer before requesting service.

**NAME PLATE LOCATION:** The graphic below indicates the location of the name plate. The model number, serial number, power requirements, etc., are located on this plate. You should record the model number, serial number, and the date of purchase in the spaces provided below and retain this manual as a permanent record of your purchase.

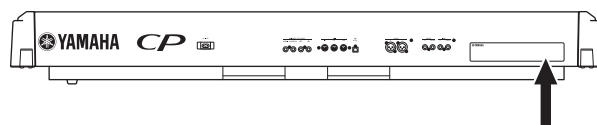

**Model** \_\_\_\_\_

**Serial No.** \_\_\_\_\_

**Purchase Date** \_\_\_\_\_

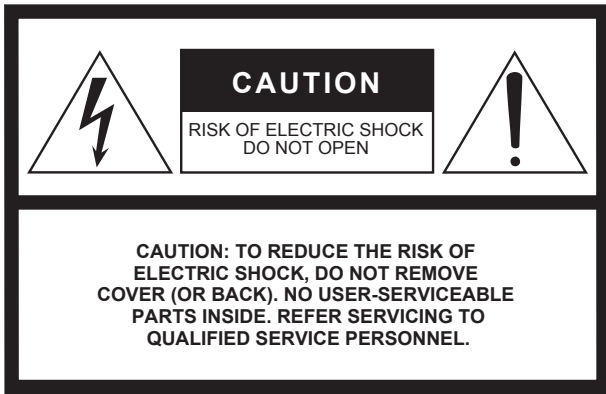

The above warning is located on the rear of the unit.

## Explanation of Graphical Symbols

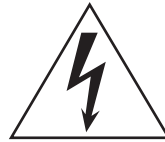

The lightning flash with arrowhead symbol within an equilateral triangle is intended to alert the user to the presence of uninsulated “dangerous voltage” within the product’s enclosure that may be of sufficient magnitude to constitute a risk of electric shock to persons.



The exclamation point within an equilateral triangle is intended to alert the user to the presence of important operating and maintenance (servicing) instructions in the literature accompanying the product.

# IMPORTANT SAFETY INSTRUCTIONS

- 1 Read these instructions.
- 2 Keep these instructions.
- 3 Heed all warnings.
- 4 Follow all instructions.
- 5 Do not use this apparatus near water.
- 6 Clean only with dry cloth.
- 7 Do not block any ventilation openings. Install in accordance with the manufacturer’s instructions.
- 8 Do not install near any heat sources such as radiators, heat registers, stoves, or other apparatus (including amplifiers) that produce heat.
- 9 Do not defeat the safety purpose of the polarized or grounding-type plug. A polarized plug has two blades with one wider than the other. A grounding type plug has two blades and a third grounding prong. The wide blade or the third prong are provided for your safety. If the provided plug does not fit into your outlet, consult an electrician for replacement of the obsolete outlet.
- 10 Protect the power cord from being walked on or pinched particularly at plugs, convenience receptacles, and the point where they exit from the apparatus.
- 11 Only use attachments/accessories specified by the manufacturer.
- 12 Use only with the cart, stand, tripod, bracket, or table specified by the manufacturer, or sold with the apparatus. When a cart is used, use caution when moving the cart/apparatus combination to avoid injury from tip-over.
- 13 Unplug this apparatus during lightning storms or when unused for long periods of time.
- 14 Refer all servicing to qualified service personnel. Servicing is required when the apparatus has been damaged in any way, such as power-supply cord or plug is damaged, liquid has been spilled or objects have fallen into the apparatus, the apparatus has been exposed to rain or moisture, does not operate normally, or has been dropped.



### WARNING

TO REDUCE THE RISK OF FIRE OR ELECTRIC SHOCK, DO NOT EXPOSE THIS APPARATUS TO RAIN OR MOISTURE.

(UL60065\_03)

**NAME PLATE LOCATION:** The graphic below indicates the location of the name plate. The model number, serial number, power requirements, etc., are located on this plate. You should record the model number, serial number, and the date of purchase in the spaces provided below and retain this manual as a permanent record of your purchase.

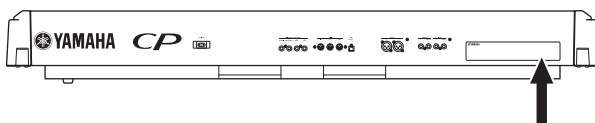

Model \_\_\_\_\_

Serial No. \_\_\_\_\_

Purchase Date \_\_\_\_\_

## FCC INFORMATION (U.S.A.)

### 1. IMPORTANT NOTICE: DO NOT MODIFY THIS UNIT!

This product, when installed as indicated in the instructions contained in this manual, meets FCC requirements. Modifications not expressly approved by Yamaha may void your authority, granted by the FCC, to use the product.

### 2. IMPORTANT:

When connecting this product to accessories and/or another product use only high quality shielded cables. Cable/s supplied with this product MUST be used. Follow all installation instructions. Failure to follow instructions could void your FCC authorization to use this product in the USA.

### 3. NOTE:

This product has been tested and found to comply with the requirements listed in FCC Regulations, Part 15 for Class "B" digital devices. Compliance with these requirements provides a reasonable level of assurance that your use of this product in a residential environment will not result in harmful interference with other electronic devices. This equipment generates/uses radio frequencies and, if not installed and used according to the instructions found in the users manual, may cause interference harmful to the operation of other electronic devices. Compliance with FCC regulations does

not guarantee that interference will not occur in all installations. If this product is found to be the source of interference, which can be determined by turning the unit "OFF" and "ON", please try to eliminate the problem by using one of the following measures:

Relocate either this product or the device that is being affected by the interference.

Utilize power outlets that are on different branch (circuit breaker or fuse) circuits or install AC line filter/s.

In the case of radio or TV interference, relocate/reorient the antenna. If the antenna lead-in is 300 ohm ribbon lead, change the lead-in to co-axial type cable.

If these corrective measures do not produce satisfactory results, please contact the local retailer authorized to distribute this type of product. If you can not locate the appropriate retailer, please contact Yamaha Corporation of America, Electronic Service Division, 6600 Orangethorpe Ave, Buena Park, CA90620

The above statements apply ONLY to those products distributed by Yamaha Corporation of America or its subsidiaries.

\* This applies only to products distributed by YAMAHA CORPORATION OF AMERICA.

(class B)

### IMPORTANT NOTICE FOR THE UNITED KINGDOM Connecting the Plug and Cord

IMPORTANT. The wires in this mains lead are coloured in accordance with the following code:

BLUE : NEUTRAL  
BROWN : LIVE

As the colours of the wires in the mains lead of this apparatus may not correspond with the coloured markings identifying the terminals in your plug proceed as follows:

The wire which is coloured BLUE must be connected to the terminal which is marked with the letter N or coloured BLACK.

The wire which is coloured BROWN must be connected to the terminal which is marked with the letter L or coloured RED.

Making sure that neither core is connected to the earth terminal of the three pin plug.

• This applies only to products distributed by Yamaha-Kemble Music (U.K.) Ltd. (2 wires)

### COMPLIANCE INFORMATION STATEMENT (DECLARATION OF CONFORMITY PROCEDURE)

Responsible Party : Yamaha Corporation of America

Address : 6600 Orangethorpe Ave.,  
Buena Park, Calif. 90620

Telephone : 714-522-9011

Type of Equipment : Stage Piano

Model Name : CP300

This device complies with Part 15 of the FCC Rules.

Operation is subject to the following two conditions:

- 1) this device may not cause harmful interference, and
- 2) this device must accept any interference received including interference that may cause undesired operation.

See user manual instructions if interference to radio reception is suspected.

\* This applies only to products distributed by  
YAMAHA CORPORATION OF AMERICA.

(FCC DoC)

# PRECAUTIONS

## PLEASE READ CAREFULLY BEFORE PROCEEDING

Please keep this manual in a safe and handy place for future reference.



### WARNING

Always follow the basic precautions listed below to avoid the possibility of serious injury or even death from electrical shock, short-circuiting, damages, fire or other hazards. These precautions include, but are not limited to, the following:

#### Power supply/Power cord

- Do not place the power cord near heat sources such as heaters or radiators. Also, do not excessively bend or otherwise damage the cord, or place heavy objects on it.
- Only use the voltage specified as correct for the instrument. The required voltage is printed on the name plate of the instrument.
- Use only the supplied power cord/plug.
- Check the electric plug periodically and remove any dirt or dust which may have accumulated on it.

#### Do not open

- This instrument contains no user-serviceable parts. Do not attempt to disassemble or modify the internal components in any way. If it should appear to be malfunctioning, discontinue use immediately and have it inspected by qualified Yamaha service personnel.

#### Water warning

- Do not expose the instrument to rain, use it near water or in damp or wet conditions, place on it any containers (such as vases, bottles or glasses) containing liquids which might spill into any openings. If any liquid such as water seeps into the instrument, turn off the power immediately and unplug the power cord from the AC outlet. Then have the instrument inspected by qualified Yamaha service personnel.
- Never insert or remove an electric plug with wet hands.

#### Fire warning

- Do not put burning items, such as candles, on the unit. A burning item may fall over and cause a fire.

#### If you notice any abnormality

- When one of the following problems occur, immediately turn off the power switch and disconnect the electric plug from the outlet. Then have the device inspected by Yamaha service personnel.
  - The power cord or plug becomes frayed or damaged.
  - It emits unusual smells or smoke.
  - Some object has been dropped into the instrument.
  - There is a sudden loss of sound during use of the instrument.



### CAUTION

Always follow the basic precautions listed below to avoid the possibility of physical injury to you or others, or damage to the instrument or other property. These precautions include, but are not limited to, the following:

#### Power supply/Power cord

- Do not connect the instrument to an electrical outlet using a multiple-connector. Doing so can result in lower sound quality, or possibly cause overheating in the outlet.
- When removing the electric plug from the instrument or an outlet, always hold the plug itself and not the cord. Pulling by the cord can damage it.
- Remove the electric plug from the outlet when the instrument is not to be used for extended periods of time, or during electrical storms.

#### Location

- Do not place the instrument in an unstable position where it might accidentally fall over.
- When transporting or moving the instrument, always use two or more people. Attempting to lift the instrument by yourself may damage your back, result in other injury, or cause damage to the instrument itself.
- Before moving the instrument, remove all connected cables, to prevent damage to the cables or injury to anyone who might trip over them.
- When setting up the product, make sure that the AC outlet you are using is easily accessible. If some trouble or malfunction occurs, immediately turn off the power switch and disconnect the plug from the outlet. Even when the power switch is turned off, electricity is still flowing to the product at the minimum level. When you are not using the product for a long time, make sure to unplug the power cord from the wall AC outlet.

## Connections

- Before connecting the instrument to other electronic components, turn off the power for all components. Before turning the power on or off for all components, set all volume levels to minimum.
- Be sure to set the volumes of all components at their minimum levels and gradually raise the volume controls while playing the instrument to set the desired listening level.

## Handling caution

- Do not insert a finger or hand in any gaps on the instrument.
- Never insert or drop paper, metallic, or other objects into the gaps on the panel. This could cause physical injury to you or others, damage to the instrument or other property, or operational failure.
- Do not rest your weight on, or place heavy objects on the instrument, and do not use excessive force on the buttons, switches or connectors.
- Do not use the instrument/device or headphones for a long period of time at a high or uncomfortable volume level, since this can cause permanent hearing loss. If you experience any hearing loss or ringing in the ears, consult a physician.

Yamaha cannot be held responsible for damage caused by improper use or modifications to the instrument, or data that is lost or destroyed.

Always turn the power off when the instrument is not in use.

## NOTICE

To avoid the possibility of malfunction/ damage to the product, damage to data, or damage to other property, follow the notices below.

### ■ Handling and Maintenance

- Do not use the instrument in the vicinity of a TV, radio, stereo equipment, mobile phone, or other electric devices. Otherwise, the instrument, TV, or radio may generate noise. When you use the instrument along with an application on your iPad, iPhone or iPod touch, we recommend that you set "Airplane Mode" to "ON" on that device in order to avoid noise caused by communication.
- Do not expose the instrument to excessive dust or vibrations, or extreme cold or heat (such as in direct sunlight, near a heater, or in a car during the day) to prevent the possibility of panel disfiguration, damage to the internal components or unstable operation.
- Do not place vinyl, plastic or rubber objects on the instrument, since this might discolor the panel or keyboard.
- When cleaning the instrument, use a soft, dry cloth. Do not use paint thinners, solvents, cleaning fluids, or chemical-impregnated wiping cloths.
- During extreme changes in temperature or humidity, condensation may occur and water may collect on the surface of the instrument. If water is left, the wooden parts may absorb the water and be damaged. Make sure to wipe any water off immediately with a soft cloth.

### ■ Saving data

- Current memory data (see page 82) is lost when you turn off the power to the instrument. Save the data to the storage memory (see page 82)/external device such as a computer.  
Saved data may be lost due to malfunction or incorrect operation. Save important data to external device such as a computer.

## Information

### ■ About copyrights

- Copying of the commercially available musical data including but not limited to MIDI data and/or audio data is strictly prohibited except for your personal use.
- This product incorporates and bundles computer programs and contents in which Yamaha owns copyrights or with respect to which it has license to use others' copyrights. Such copyrighted materials include, without limitation, all computer software, style files, MIDI files, WAVE data, musical scores and sound recordings. Any unauthorized use of such programs and contents outside of personal use is not permitted under relevant laws. Any violation of copyright has legal consequences. DON'T MAKE, DISTRIBUTE OR USE ILLEGAL COPIES.

### ■ About functions/data bundled with the instrument

- This device is capable of using various types/formats of music data by optimizing them to the proper format music data for use with the device in advance. As a result, this device may not play them back precisely as their producers or composers originally intended.

### ■ About this manual

- The illustrations and LCD screens as shown in this manual are for instructional purposes only, and may appear somewhat different from those on your instrument.
- Windows is a registered trademark of Microsoft® Corporation in the United States and other countries.
- Apple, Mac, Macintosh, iPad, iPhone and iPod touch are trademarks of Apple Inc., registered in the U.S. and other countries.
- The company names and product names in this manual are the trademarks or registered trademarks of their respective companies.

## Introduction

---

Thank you for choosing the Yamaha Stage Piano CP300. The CP300 features exceptionally high-quality sound, comprehensive features and a variety of editing functions—making it suitable for a wide range of applications, including live performance and recording.

We recommend that you read this manual carefully so that you can fully take advantage of the advanced and convenient functions of the CP300. We also recommend that you keep this manual in a safe and handy place for future reference.

## About this Owner's Manual

---

This manual consists of four main sections: Introduction, Basic Operation, Reference and Appendix.

### **Introduction (page 6)**

Please read this section first.

### **Basic Operation (page 20)**

This section explains the basic functions and how to use them in detail. Refer to this section while you play the CP300.

### **Reference (page 53)**

This section explains how to make detailed settings for the CP300's various functions. Refer to this section as necessary.

### **Appendix (page 94)**

This section contains important reference material, including Voice and Drum Kit lists, and various detailed charts and tables.

- The illustrations and LCD displays as shown in this Owner's Manual are for instructional purposes only, and may appear somewhat different from those on your instrument.

Copying of the commercially available musical data including but not limited to MIDI data and/or audio data is strictly prohibited except for your personal use. If you wish to use such data for occasions other than personal use, consult a copyright expert.

This product incorporates and bundles computer programs and contents in which Yamaha owns copyrights or with respect to which it has license to use others' copyrights. Such copyrighted materials include, without limitation, all computer software, style files, MIDI files, WAVE data, musical scores and sound recordings. Any unauthorized use of such programs and contents outside of personal use is not permitted under relevant laws. Any violation of copyright has legal consequences. **DON'T MAKE, DISTRIBUTE OR USE ILLEGAL COPIES.** This device is capable of using various types/formats of music data by optimizing them to the proper format music data for use with the device in advance. As a result, this device may not play them back precisely as their producers or composers originally intended.

### Trademarks

- Windows is the registered trademark of Microsoft® Corporation.
- Apple and Macintosh are trademarks of Apple Computer, Inc.
- The company names and product names in this Owner's Manual are the trademarks or registered trademarks of their respective companies.



## Supplied Accessories

---

- Power cord
- Foot pedal (FC3)
- Owner's Manual

## Main Features

---

The CP300 gives you the ultimate acoustic grand piano sound—utilizing three-stage dynamic sampling, providing the ability to change tone with the sustain pedal, and adding a subtle, authentic release sound when you lift your fingers from the keys.

Among the advanced features are:

- 88-key “Graded Hammer” keyboard with action that is virtually indistinguishable from an actual acoustic piano.
- Sophisticated AWM synthesis engine and tone generation system, with a maximum polyphony of 128 notes. Using AWM, the CP300 has 50 original Voices—including a variety of ultra-realistic piano and other keyboard Voices, plus a wealth of authentic sounds of virtually every instrument type.
- High-grade five-band Master EQ, which enables you to control the tone intuitively using sliders on the panel.
- Luscious reverb and chorus effects, plus an enormous variety of other effects that add extraordinary depth and expression to your sound.
- Comprehensive MIDI functions for use with other devices and in larger music production systems.
- Four pedal connectors for maximum expressive capabilities—especially ideal for live performance—and built-in high-quality stereo speakers.
- A powerful, versatile Performance function, which lets you store and instantly recall your custom CP300 settings, including Dual/Split configurations, Voice and effect parameters, MIDI transmit/receive channel values and Master Edit settings.
- Built-in 16-track sequencer for recording and playing back your keyboard performance, as well as for creating complex multi-instrument arrangements and Songs—up to a maximum 16 parts.
- Master mode, which allows you to independently control up to four external tone generators.
- Comprehensive selection of inputs/outputs and interfaces—including two separate stereo output pairs, stereo inputs, MIDI terminals, and a USB connector.

# Contents

<b>Introduction</b> . . . . .	<b>6</b>
Application Index . . . . .	10
<b>Before Using the CP300</b> . . . . .	<b>11</b>
Power Supply Connections . . . . .	11
Using the Pedals . . . . .	11
Using Headphones . . . . .	12
Turning the Power On . . . . .	12
Adjusting the Brightness of the Display . . . . .	13
Setting the Volume . . . . .	13
<b>Playing the keyboard</b> . . . . .	<b>14</b>
Playing the Sounds . . . . .	14
<b>Basic Operation</b> . . . . .	<b>15</b>
Display Settings—Basic Operation . . . . .	15
Restoring the Factory-programmed Settings of the CP300 . . . . .	16
<b>Basic Instructions</b> . . . . .	<b>18</b>
<b>Basic Operation</b> . . . . .	<b>20</b>
<b>Control Names and Functions</b> . . . . .	<b>20</b>
Front Panel . . . . .	20
Rear Panel . . . . .	22
<b>Quick Guide</b> . . . . .	<b>23</b>
Listening to the Demo Songs . . . . .	23
Playing Voices . . . . .	25
Playing Different Voices Simultaneously . . . . .	27
Changing the Volume for Each Part (Zone Control) . . . . .	28
Combining Voices—Dual . . . . .	29
Playing Different Voices with the Left and Right Hands—Split . . . . .	31
Using the Pedals . . . . .	33
Bending Notes—Pitch Bend Wheel . . . . .	34
Adding a Vibrato Effect to the Sound—Modulation Wheel . . . . .	34
Enhancing the Sound with Reverb and Chorus . . . . .	35
Equalizer (EQ) . . . . .	36
Key Transposition—Transpose . . . . .	37
Using the Click . . . . .	38
<b>Using the Master Mode</b> . . . . .	<b>39</b>
<b>Selecting a Performance</b> . . . . .	<b>40</b>
<b>Recording Your Performance</b> . . . . .	<b>41</b>
Recording Your Performance . . . . .	42
Re-recording Parts of a Song . . . . .	44
Other Recording Techniques . . . . .	46
<b>Song Playback</b> . . . . .	<b>49</b>
Playing Back a Song . . . . .	49
<b>Convenient Functions</b> . . . . .	<b>51</b>
Panel Lock Function . . . . .	51
MIDI Transmission On/Off . . . . .	51

MIDI Panic Control . . . . .	52
Built-in Speakers On/Off . . . . .	52
<b>Reference Section . . . . .</b>	<b>53</b>
<b>Master Settings—Master Edit . . . . .</b>	<b>53</b>
<b>Detailed Settings for the Voices—Voice Edit . . . . .</b>	<b>56</b>
Voice Edit—Basic Operation . . . . .	56
<b>Detailed Settings for MIDI Operations—MIDI Settings . . . . .</b>	<b>63</b>
About MIDI . . . . .	63
MIDI Settings—Basic Operation . . . . .	64
<b>Miscellaneous CP300 Settings—Other Settings . . . . .</b>	<b>67</b>
Other Settings—Basic Operation . . . . .	67
<b>Master Equalizer Settings . . . . .</b>	<b>72</b>
<b>Using the Performance Functions . . . . .</b>	<b>73</b>
Performance Parameters . . . . .	74
<b>Handling Performance Files . . . . .</b>	<b>76</b>
Performance File—Basic Operation . . . . .	76
<b>Handling Song Files . . . . .</b>	<b>81</b>
Song File—Basic Operation . . . . .	81
<b>Settings for Song Recording and Playback—Song Settings . . . . .</b>	<b>85</b>
Song Settings—Basic Operation . . . . .	85
<b>Connecting to a Computer and Other MIDI Devices . . . . .</b>	<b>88</b>
Connecting to External Audio Equipment . . . . .	88
Connecting to External Equipment . . . . .	89
Connecting to External MIDI Equipment . . . . .	90
Connecting to a Computer . . . . .	92
<b>Appendix . . . . .</b>	<b>94</b>
<b>Message List . . . . .</b>	<b>94</b>
<b>Troubleshooting . . . . .</b>	<b>98</b>
<b>MIDI Data Compatibility . . . . .</b>	<b>100</b>
<b>Factory Setting List . . . . .</b>	<b>101</b>
<b>Voice List . . . . .</b>	<b>103</b>
<b>Program Change List . . . . .</b>	<b>105</b>
<b>Preset Performance List . . . . .</b>	<b>106</b>
<b>XG Voice List . . . . .</b>	<b>108</b>
<b>XG Drum Kit List . . . . .</b>	<b>112</b>
<b>Effect Type List . . . . .</b>	<b>114</b>
<b>Effect Parameter List . . . . .</b>	<b>115</b>
<b>Effect Data Assign Table . . . . .</b>	<b>123</b>
<b>MIDI Data Format . . . . .</b>	<b>125</b>
<b>MIDI Implementation Chart . . . . .</b>	<b>137</b>
<b>Specifications . . . . .</b>	<b>138</b>
<b>Index . . . . .</b>	<b>139</b>

# Application Index

## Listening

- Listening to Demo Songs with different Voices . . . . . “Listening to the Demo Songs” on page 23
- Listening to your recorded performance . . . . . “Playing Back a Song” on page 49

## Playing

- Selecting and playing Voices . . . . . “Playing Voices” on page 25
- Selecting and playing Performances . . . . . “Selecting a Performance” on page 40
- Using different pedals . . . . . “Using the Pedals” on page 33
- Using multiple MIDI tone generators . . . . . “Using the Master Mode” on page 39

## Changing Voices

- Viewing the list of Voices . . . . . “Voice List” on page 103
- Viewing the list of Performances . . . . . “Preset Performance List” on page 106
- Combining Voices . . . . . “Combining Voices—Dual” on page 29
- Playing different sounds with left and right hands  
. . . . . “Playing Different Voices with the Left and Right Hands—Split” on page 31
- Adding Variations to the Sound . . . . . “Bending Notes—Pitch Bend Wheel” on page 34  
“Adding a Vibrato Effect to the Sound—Modulation Wheel” on page 34  
“Enhancing the Sound with Reverb and Chorus” on page 35  
“Equalizer (EQ)” on page 36

## Recording

- Recording your performance . . . . . “Recording Your Performance” on page 42
- Deleting recorded Songs . . . . . “Handling Song Files” on page 81

## Settings

- Making detailed settings for Voices . . . . . “Detailed Settings for the Voices—Voice Edit” on page 56
- Making detailed settings for the entire CP300 “Miscellaneous CP300 Settings—Other Settings” on page 67
- Making settings for Master mode . . . . . “Master Settings—Master Edit” on page 53
- Making detailed settings for MIDI . . . . . “Detailed Settings for MIDI Operations—MIDI Settings” on page 63
- Making detailed settings for Master Equalizer . . . . . “Master Equalizer Settings” on page 72

## Saving

- Saving the Voice settings . . . . . “Handling Performance Files” on page 76

## Connecting the CP300 to other devices

- What is MIDI? . . . . . “About MIDI” on page 63
- Connecting to multiple MIDI devices . . . . . “Connecting to External MIDI Equipment” on page 90
- Raising the volume . . . . . “Connecting to External Audio Equipment” on page 88
- Connecting to a computer . . . . . “Connecting to a Computer” on page 92

## Quick solutions

- Returning to the main display . . . . . “Display Settings—Basic Operation” on page 15
- Resetting the default settings . . . . . “Restoring the Factory-programmed Settings of the CP300” on page 16
- About the display messages . . . . . “Message List” on page 94
- Troubleshooting . . . . . “Troubleshooting” on page 98

# Before Using the CP300

## Power Supply Connections

- 1 Make sure that the instrument's [POWER] switch on the rear panel is at the OFF position.

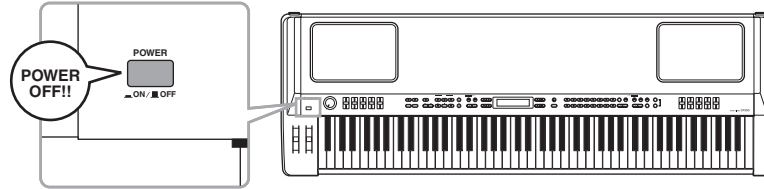

- 2 Connect the supplied power cord to the [AC INLET] jack (page 22) on the instrument's rear panel.
- 3 Connect the other end of the power cord to an AC outlet. Make sure your CP300 meets the voltage requirement for the country or region in which it is being used.

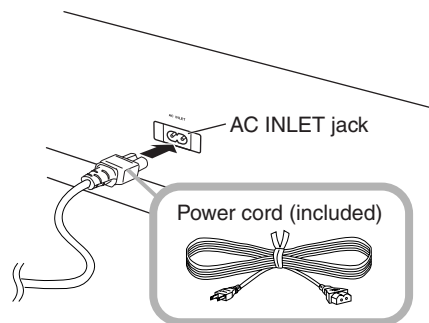

## Using the Pedals

Connect the included pedal (FC3) to the [1 SUSTAIN] jack. An optional FC3/FC4/FC5 foot switch or FC7 foot controller can alternately be connected to this jack. Also an optional FC3/FC4/FC5 foot switch or FC7 foot controller can be connected to the [4 AUX] jack, and can be assigned to control a variety of parameters on the instrument (page 33).

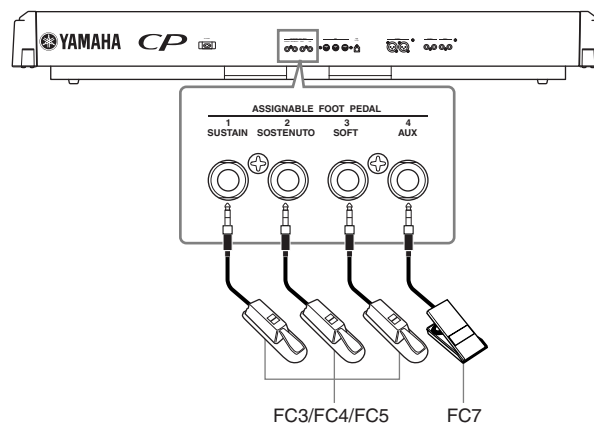

## Using Headphones

If you are using a set of headphones, connect them to the [PHONES] jack.

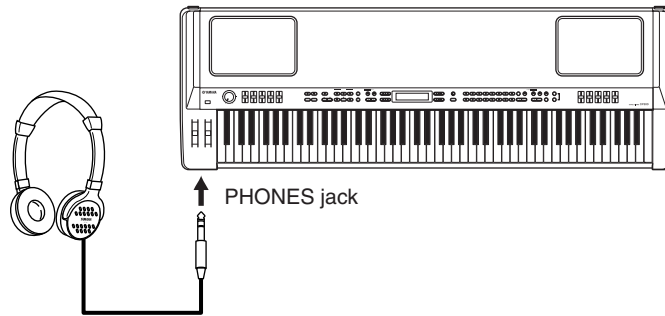

### **CAUTION**

Do not use headphones at a high volume for an extended period of time. Doing so may cause hearing loss.

**NOTE** If the [SPEAKER] button is lit, this indicates that the built-in speakers sound normally when using the headphones.

## Turning the Power On

Make sure the volume setting of the CP300 and external devices are turned down to the minimum. Press the [POWER] switch to turn the power on.

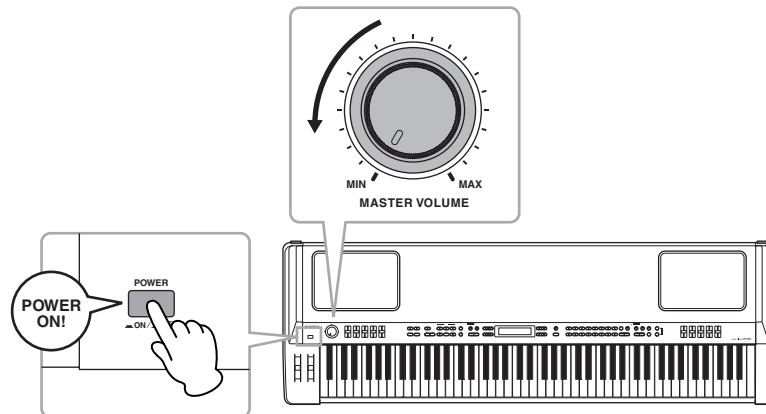

The display located in the center of the front panel lights up.

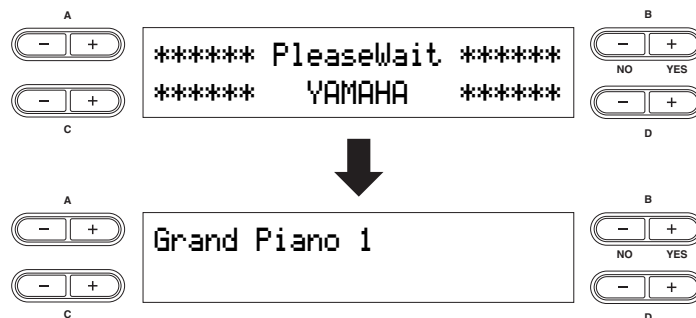

Press the [POWER] switch again to turn off the power to the CP300. The display will disappear.

## Adjusting the Brightness of the Display

You can adjust the contrast of the display by turning the [CONTRAST] knob located to the right of the LCD.

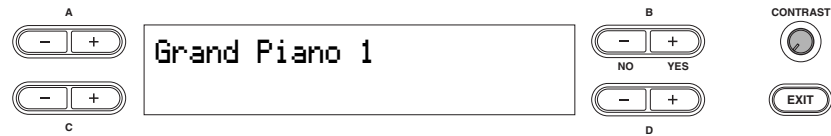

## Setting the Volume

To adjust the volume, use the [MASTER VOLUME] dial located at the left of the panel. When you start playing, re-adjust the [MASTER VOLUME] dial to the most comfortable listening level.

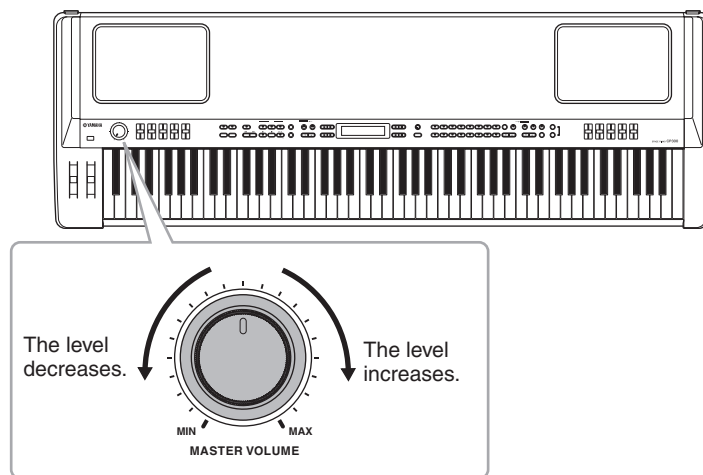

### Terminology

**Master Volume:** The volume level of the entire keyboard sound.

**NOTE** The [MASTER VOLUME] dial also controls the volume of the headphones.

# Playing the keyboard

## Playing the Sounds

Try playing some of the realistic and dynamic CP300 sounds from the keyboard now. When you turn the power on following the directions in “Power Supply Connections” (pages 11 and 12), the display below appears.

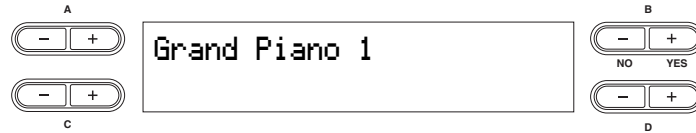

In this condition, you can play the keyboard and hear the sound of the selected “Grand Piano 1” Voice. To change the Voice, press any one of the Voice group buttons located at the right of the panel.

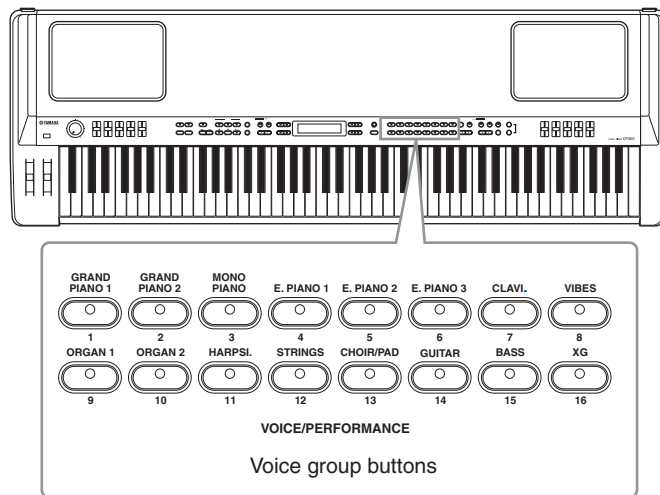

Play the keyboard and enjoy the sound.

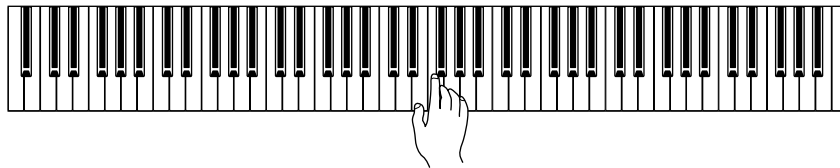



# Basic Operation

In this section you'll learn about the fundamental operations of the CP300—the use of the panel buttons and controls and how to restore the CP300's memory to the factory default settings.

## Display Settings—Basic Operation

Each function may have many items or parameters from which you can choose. To select an item or parameter, press one of the A [-][+] – D [-][+] buttons.

Each parameter in the display corresponds to the A [-][+] – D [-][+] buttons next to it.

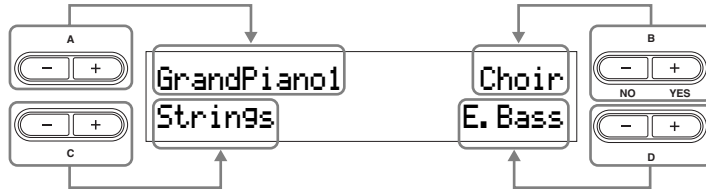

Sometimes, after you've changed the parameter values or settings, you may want to reset them to their normal condition. To do this, simply press the [-] button and [+] button simultaneously.

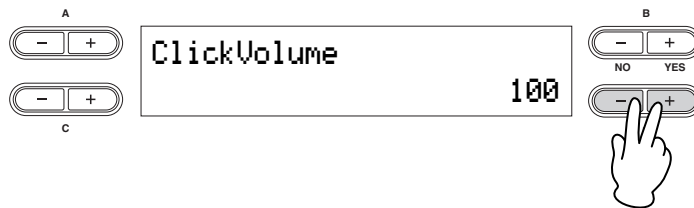

**NOTE** The TEMPO [DOWN][UP] buttons are the same shape as the A [-][+] – D [-][+] buttons. Parameters corresponding to button pairs of this shape can all be reset to their default values by pressing both buttons simultaneously.

To execute the operation, press B [+ (YES)] button. To cancel the operation, press the B [- (NO)] button. In general, when a prompt is shown on the upper right of the display, press the appropriate B [- (NO)] [+ (YES)] buttons to execute or cancel the operation.

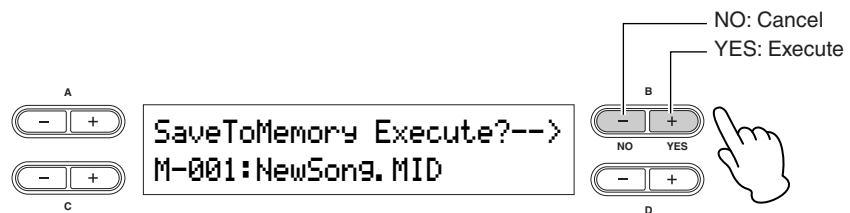

Press the [EXIT] button to exit from a function.

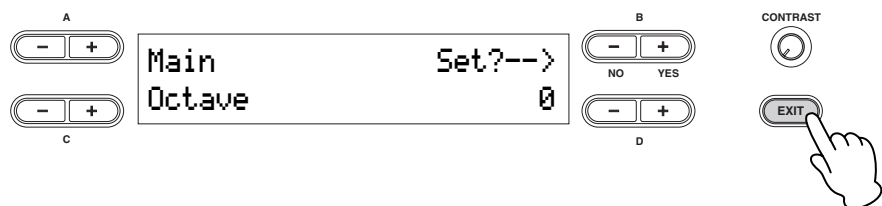

# Restoring the Factory-programmed Settings of the CP300

The CP300 has a Factory Set function for restoring your CP300's memory to the factory default settings. This lets you restore the CP300's default Voices and Performances, as well as its System and other settings. Refer to "Factory Setting List" on page 101.

There are two ways you can restore the CP300's memory to the factory default settings: 1) Set the "Factory Set" parameter in the Other Settings menu, or 2) Turn the power off and turn the power on again while holding the C7 key (rightmost key on the keyboard).

## Method 1

**1** Press the [OTHER SETTING] button to access the Other Settings menu.

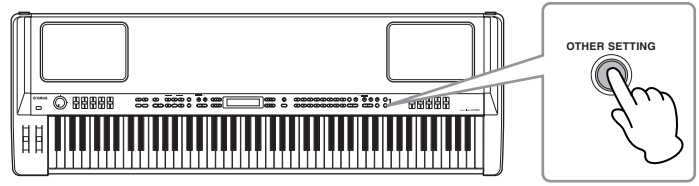

**2** Press the [OTHER SETTING] button repeatedly or use the A [-][+] buttons to call up "Factory Set" in the display.

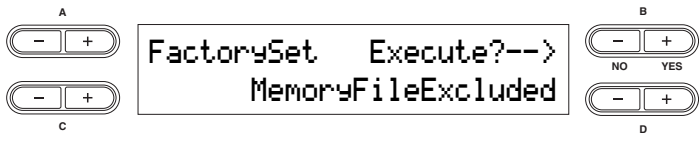

**3** Use the D [-][+] buttons to select either "Memory File Excluded" or "Memory File Included."

**Storage memory selections:**

- Memory File Excluded.....Memory files are maintained.
- Memory File Included .....Memory files are erased.

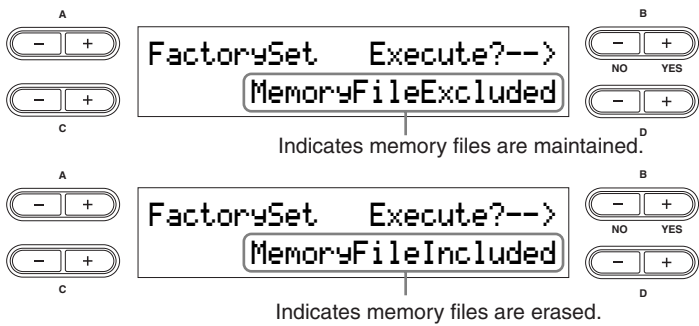

**NOTE** The "Character Code" parameter in the Song File menu does not change (page 84).

#### 4 Press the B [+ (YES)] button to execute the job.

After the job has been completed, a “Completed” message appears and operation returns to the original display.

#### CAUTION

For Factory Set operations that take longer to process, you will see the message “Executing” during processing. Do not switch the power off while this message is on the display. Turning the power off in this state may cause the system to freeze.

#### Terminology

**File:** A file contains various data in a group. A file includes both Performance data and Song data (pages 73, 81).

## Method 2

Simultaneously hold down the white key on the right end of the keyboard (C7), and press the [POWER] switch to turn on the power to the CP300.

In this case, the Memory files saved in the storage memory are not erased.

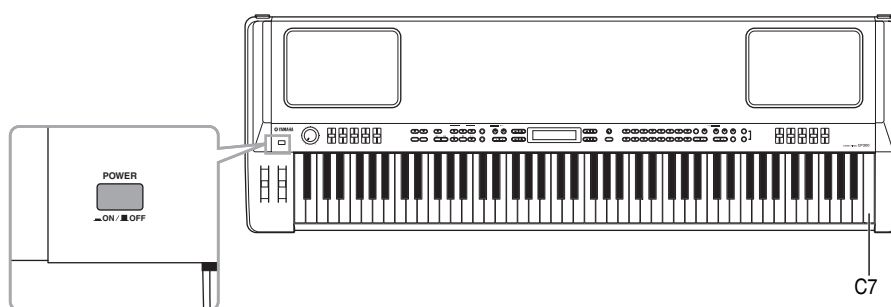

If you wish to erase Memory files at this time, simultaneously hold down the rightmost white key (C7) and black key (B♭6) together and press the [POWER] switch to turn on the power to the CP300.

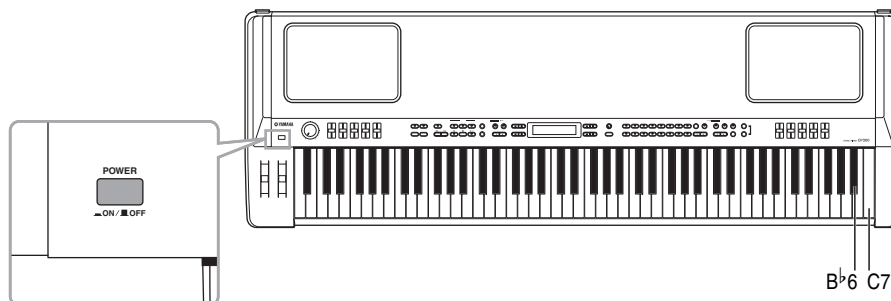

#### Terminology

**Storage memory:** This memory area enables you to save Performance files and recorded Songs.

# Basic Instructions

## Turning the Power On

First, turn the power on and set up the keyboard before playing.

- **Before Using the CP300 (pages 11 and 12)**

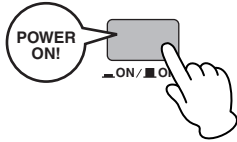

## Selecting and Playing a Voice

The CP300 features an exceptionally wide variety of Preset Voices for playing in virtually any musical style. Try searching through the Voices to find your favorites.

- **Selecting a Voice (page 25)**

### Terminology

**Preset:** Refers to data loaded to the internal memory of the CP300 before being shipped from the factory.

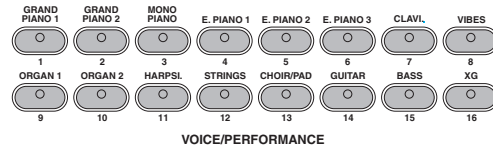

## Combining Voices and Playing Them on the Keyboard

The CP300 allows you to play several different Voices together in a layer, or play one Voice with your left hand while you play a different Voice (or even two layered Voices!) with your right. Try out some of the variations and experiment with your own Voice combinations.

- **Playing Different Voices Simultaneously (page 27)**
- **Combining Voices—Dual (page 29)**
- **Playing Different Voices with the Left and Right Hands—Split (page 31)**

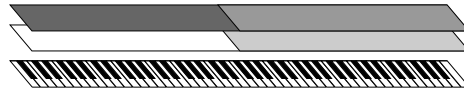

## Create Your Own Original Voices

Once you've explored your favorite Voices and feel comfortable with them, try branching out creatively and use the editing features to make your own original Voices.

- **Detailed Settings for the Voices—Voice Edit (page 56)**

## Connecting to a Computer and MIDI devices

- **Connecting to External Audio Equipment (page 88)**
- **Connecting to External MIDI Equipment (page 90)**
- **Connecting to a Computer (page 92)**

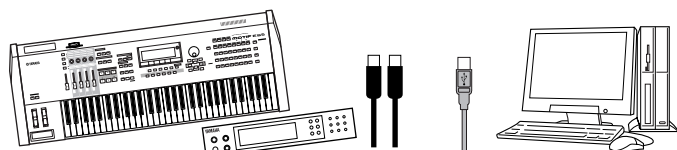

## Recording Your Performance and Playing It Back

Recording and playing back your performance is exceptionally easy. The CP-300 allows you to record up to sixteen independent parts, letting you record the left- and right-hand parts separately—and lets you build up a complete, multi-instrument Song by recording each part one-by-one.

- **Recording Your Performance (page 42)**
- **Other Recording Techniques (page 46)**
- **Handling Song Files (page 81)**
- **Playing Back Songs (page 49)**

### Terminology

On the CP300, performance data is called a “Song.” This includes demonstration tunes and piano preset tunes.

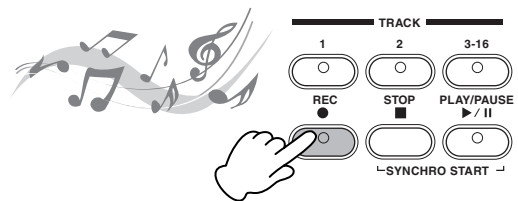

## Using the Performance Functions

The useful Performance functions enable you to store and recall the entire CP300 settings all together. These include the Dual/Split settings, Voice and effect parameters, MIDI transmit/receive channel settings and Master Edit settings. If you have any original Voices you’ve created, you can save these to a Performance as well.

- **Using the Performance Functions (page 73)**
- **Selecting a Performance (page 40)**
- **Performance Parameters (page 74)**
- **Handling Performance Files (page 76)**

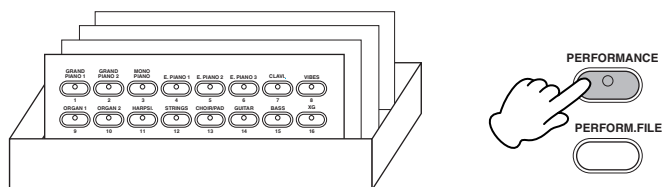

## Using as a Master Keyboard

The Master mode of the instrument enables you to control up to four external tone generators (or four separate instrument parts on one multi-timbral tone generator). This effectively lets you play four different MIDI instruments at one time. Once you’ve created your custom Master settings, you can save them to a Performance as well.

- **Using the Master Mode (page 39)**
- **Master Settings—Master Edit (page 53)**

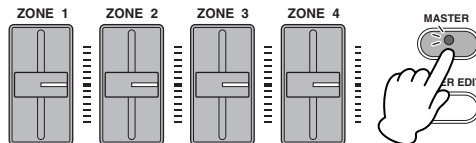

# Basic Operation

## Control Names and Functions

### Front Panel

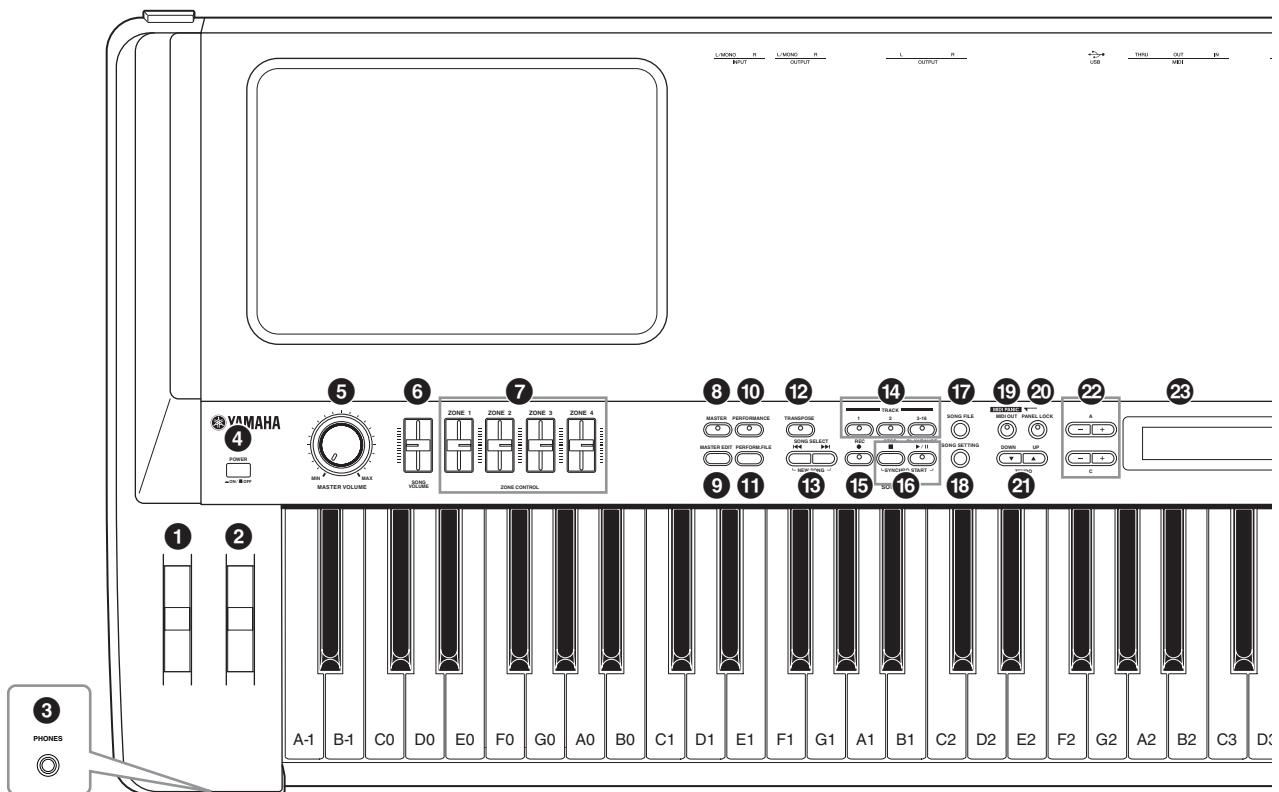

- |  |   |
|--|---|
| <p><b>1 Pitch Bend wheel</b> (page 34)<br/>Controls the pitch bend effect.</p> <p><b>2 Modulation wheel</b> (page 34)<br/>Controls the modulation effect.</p> <p><b>3 [PHONES] jack</b> (page 12)<br/>For connection to a pair of stereo headphones.</p> <p><b>4 [POWER] switch</b> (page 12)<br/>For turning the power on or off. The power is turned on if the button is set to this position: . The power is turned off if the button is set this way: .</p> <p><b>5 [MASTER VOLUME] dial</b> (page 13)<br/>Adjusts the overall volume.</p> <p><b>6 [SONG VOLUME] slider</b> (page 47)<br/>Adjusts the volume of the Song playback.</p> | <p><b>7 [ZONE CONTROL] sliders</b> (pages 28, 39)<br/>These four sliders adjust the output level for each Layer parts (up to four). Turning on the [MASTER] button switches the function assigned to the [ZONE CONTROL] sliders.</p> <p><b>8 [MASTER] button</b> (page 39)<br/>Turning on the [MASTER] button switches the CP300 to function as a Master keyboard.</p> <p><b>9 [MASTER EDIT] button</b> (page 53)<br/>Enables selection of the settings for the Master mode.</p> <p><b>10 [PERFORMANCE] button</b> (page 40)<br/>Switches the Performance on/off.</p> <p><b>11 [PERFORM.FILE] button</b> (page 76)<br/>Enables selection of Performance File settings, such as saving and deleting Performance data, and making other settings for Performance files.</p> |
|--|---|

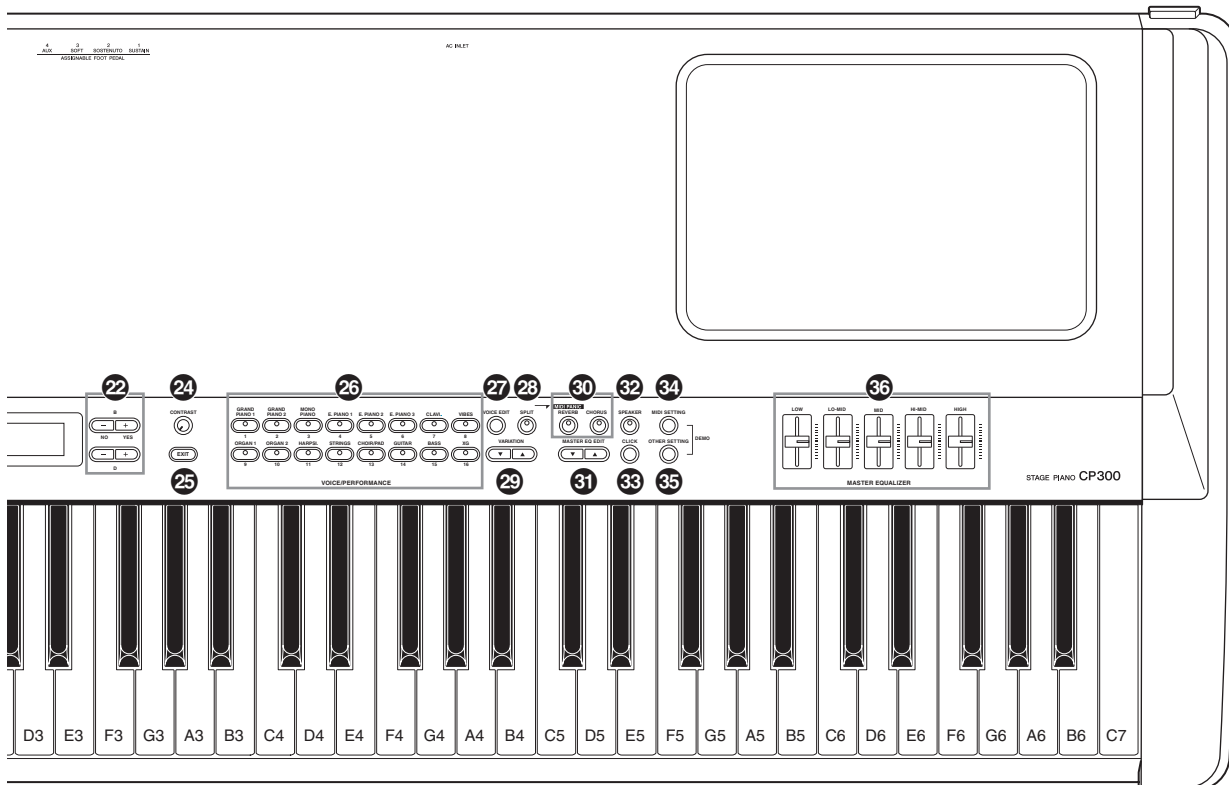

**12 [TRANSPOSE] button (page 37)**

The Transpose function makes it possible to shift the pitch of the entire keyboard up or down, letting you easily match the pitch of the keyboard to the range of a singer or other instruments.

**13 SONG SELECT [◀◀][▶▶] buttons (pages 42, 49)**

Selects a Preset Song or one of your recorded Songs.

**14 TRACK [1], [2], and [3-16] buttons (page 50)**

For turning off the specified track as required so you can practice the corresponding track (the track that is turned off) on the keyboard.

**15 SONG [REC] button (page 42)**

For recording your keyboard performance.

**16 SONG [PLAY/PAUSE], [STOP] buttons (page 49)**

Plays back the Preset Songs or your recorded Songs.

**17 [SONG FILE] button (page 81)**

Saves recorded Songs and makes other settings for Song files.

**18 [SONG SETTING] button (page 85)**

Enables selection of the settings for playback of recorded Songs.

**19 [MIDI OUT] button (page 51)**

Switches MIDI transmission on/off.

**20 [PANEL LOCK] button (page 51)**

Switches panel lock on/off. Turning on the button disables the panel operations.

**21 TEMPO [UP]/[DOWN] buttons (page 38)**

Adjusts the tempo.

## Control Names and Functions

- 22 [A to D [-][+] buttons** (page 15)  
For selecting parameters and changing values while viewing the display.
- 23 [Display]** (page 15)  
For showing various messages and certain settings of the instrument.
- 24 [CONTRAST] knob** (page 13)  
Adjusts the brightness of the display.
- 25 [EXIT] button** (page 15)  
Returns to the initial display (the display that first appears when the power is turned on).
- 26 [Voice group buttons]** (pages 25, 40)  
These let you select from sixteen groups of Voices, including grand piano. You can also select a Performance if the [PERFORMANCE] button is turned on.
- 27 [VOICE EDIT] button** (page 56)  
Enables selection of detailed settings of the sounds and effects.
- 28 [SPLIT] button** (page 31)  
Allows you to play different Voices on the left- and right-hand sections of the keyboard.
- 29 [VARIATION [▼][▲] buttons]** (page 25)  
Enables selection of alternate Voices in the selected Voice group.
- 30 [REVERB], [CHORUS] buttons** (page 35)  
These add ambience (Reverb) and depth (Chorus) to the sound. You can turn the corresponding effect on or off with a single touch.
- 31 [MASTER EQ EDIT [▼][▲] buttons]** (page 72)  
Enables selection of detailed settings for the Master Equalizer.
- 32 [SPEAKER] button** (page 52)  
Switches the built-in speakers on or off.
- 33 [CLICK] button** (page 38)  
Switches the click function on or off.
- 34 [MIDI SETTING] button** (page 64)  
Enables selection of detailed MIDI settings.
- 35 [OTHER SETTING] button** (page 67)  
This lets you make detailed settings, such as adjusting the keyboard touch or making fine adjustments to the scale.
- 36 [MASTER EQUALIZER] sliders** (page 36)  
These five sliders adjust the tone of each band: LOW (low band) to HIGH (high band).

## Rear Panel

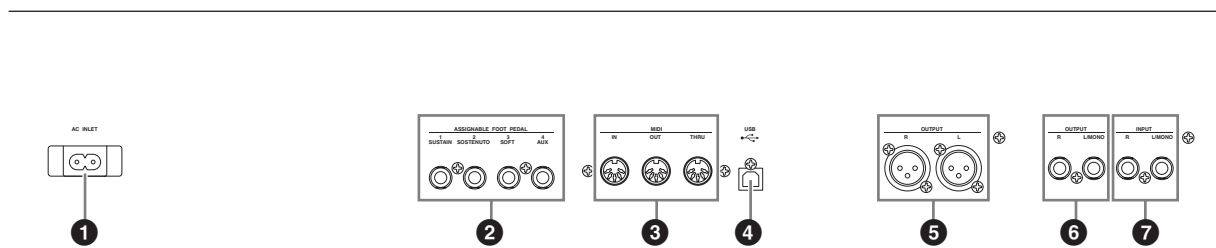

- 1 [AC INLET] jack** (page 11)  
Connect the supplied AC power cord here. Use only the AC power cord supplied with the CP300.
- 2 [ASSIGNABLE FOOT PEDAL] jacks** (pages 11, 33)  
For connecting the included pedal (FC3), an optional FC4/5 foot switch, or FC7 foot controller.
- 3 [MIDI [IN][OUT][THRU] connectors]** (page 90)  
For connecting external MIDI devices, allowing the use of various MIDI functions.
- 4 [USB] connector** (page 92)  
For connecting the CP300 and computer.
- 5 [OUTPUT [L][R] jacks]** (page 88)  
These jacks output balanced audio signals, and are for connection to an external device such as a mixer.
- 6 [OUTPUT [L/MONO][R] jacks]** (page 88)  
These jacks output stereo audio signals (1/4" mono phone plug). For monophonic output, use just the L/MONO jack.
- 7 [INPUT [L/MONO][R] jacks]** (page 89)  
External audio signals can be input via these phone jacks (1/4" mono phone plug). The sound of an external instrument can be reproduced via the CP300's speakers. Use 1/4" mono phone plugs. For stereo input from an audio device, connect to both the L/MONO and R jacks.



# Quick Guide

## Listening to the Demo Songs

The CP300 has a variety of specially recorded Demo Songs that effectively showcase each of the instrument's Voice groups. Listen to some of these Demo Songs now and hear the wide-ranging capabilities of the CP300.

**NOTE** Make sure the CP300 is ready for playback. Details are given in the section "Before Using the CP300" on page 11.

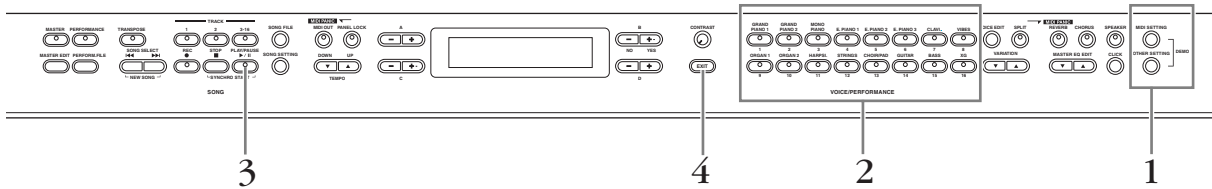

- 1 Simultaneously press both the [MIDI SETTING] button and the [OTHER SETTING] button.

The Voice group button indicators will flash in sequence.  
The "Voice Demo" message appears in the display.

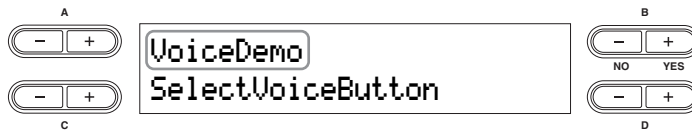

- 2 Press one of the Voice group buttons to listen to the Demo Songs.

The corresponding Voice button indicator lights up and playback starts. Demo Songs provided for each Voice group will play back in sequence until you press the [STOP] button.

### Adjusting the Volume

To adjust the volume level of the Demo Songs, use the [MASTER VOLUME] dial or [SONG VOLUME] slider.

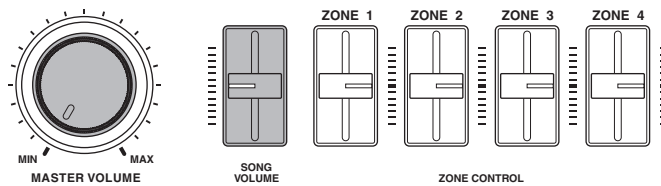

**NOTE** Make sure that the [SONG VOLUME] slider is set appropriately. If the [SONG VOLUME] slider is set to minimum, no sound can be heard.

- 3 Press the button of the Voice group currently being played or the [PLAY/PAUSE] button to stop the Voice demo.
- 4 Press the [EXIT] button to exit the Demo selection display.

# Listening to the Piano Demo Songs

**1** Simultaneously press both the [MIDI SETTING] button and the [OTHER SETTING] button.

**2** Use the A [-][+] buttons to select the Piano Demo Songs.  
The “Piano Demo” message appears in the display.

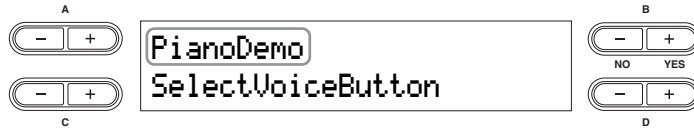

**3** Press one of the Voice group buttons to listen to the corresponding Piano Demo Song.

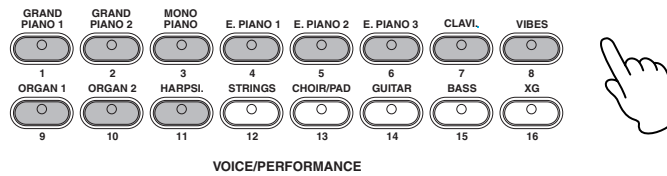

The Piano Demo Songs are assigned to the sound buttons as follows.

	Voice Name	Piano Demo Song	Description
1	GRAND PIANO 1	Stereo sampling	Song recorded in stereo.
2	GRAND PIANO 2	Mono sampling	Song recorded with a mono sampled sound.
3	MONO PIANO	Dynamic sampling: mezzopiano	Showcases the Dynamic Sampling feature, with multiple velocity-switched samples to accurately simulate the timbral response of an acoustic instrument.
4	E. PIANO 1	Dynamic sampling: mezzoforte	
5	E. PIANO 2	Dynamic sampling: forte	
6	E. PIANO 3	With Sustain (with Sustain Sampling)	Showcases the Sustain Sampling feature, which reproduces the unique resonance of an acoustic grand piano's soundboard and strings when the damper pedal is pressed.
7	CLAVI.	No Sustain (without Sustain Sampling)	
8	VIBES	With KeyOff (with Key-off Sampling)	Showcases the Key-off Samples that add the subtle sound produced when the keys are released on an acoustic piano.
9	ORGAN 1	No KeyOff (without Key-off Sampling)	
10	ORGAN 2	With String Resonance	Showcases the String Resonance feature that recreates the characteristic resonance of actual piano strings.
11	HARPSI.	No String Resonance	

# Playing Voices

## Selecting a Voice

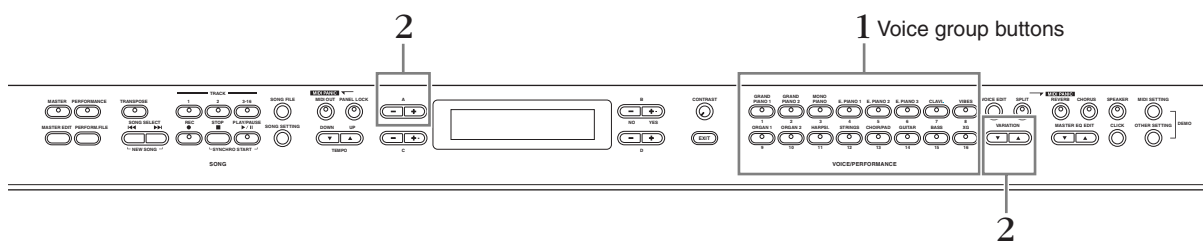

**1** Select the desired Voice group button by pressing one of the Voice group buttons. In this step, press the [GRAND PIANO 1] button.

**NOTE** Make sure the [PERFORMANCE] button is turned off. For details about Performances, refer to page 73.

**NOTE** Refer to the “Voice List” on page 103 for more information on the characteristics of each Preset Voice.

**2** Select the desired Voice by using the VARIATION [▼][▲] buttons or the A [-][+] buttons.

The currently selected Voice will sound when you play the keyboard.

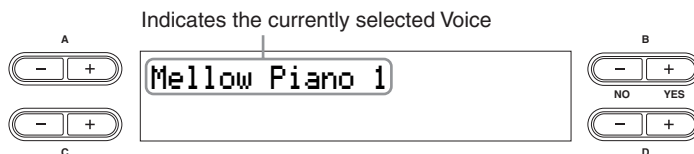

Voice Group	Voice Name
GrandPiano1	Grand Piano 1
	Mellow Piano 1
	Rock Piano
	Honky Tonk Piano
GrandPiano2	Grand Piano 2
	Mellow Piano 2
MonoPiano	Mono Piano 1
	Mono Piano 2
	Comp. Piano 1
	Comp. Piano 2
E.Piano1	Chorus E.Piano
	Phaser E.Piano
	AutoPan E.Piano
	Standard E.Piano
E.Piano2	DX E.Piano 1
	DX E.Piano 2
	Synth Piano
E.Piano3	Tremolo Vintage E.P.
	Vintage E.Piano
	Amp.Sim.Vintage E.P.
Clavi.	Phaser Clavi.
	Clavi. 1
	Wah Clavi.
	Clavi. 2
Vibraphone	Vibraphone
	Marimba
	Celesta

Voice Group	Voice Name
Organ1	Jazz Organ
	Theater Organ
	Rock Organ
	Draw Organ
Organ2	Pipe Organ Principal
	Pipe Organ Tutti
	Pipe Organ Flute
Harpsichord	Harpsichord 8'
	Harpsichord 8'+4'
Strings	Strings
	Synth Strings
	Slow Strings
Choir/Pad	Choir
	Slow Choir
	Scat
	Synth Pad 1
Guitar	Nylon Guitar
	Steel Guitar
Bass	Wood Bass
	Bass&Cymbal
	Electric Bass
	Fretless Bass
XG	XG Voice

Basic Operation

## About XG Voices

The XG Voices are categorized and contained in appropriate folders. Select the XG Voice group first, then select the desired Voice.

### 2-1 Press the [XG] button.

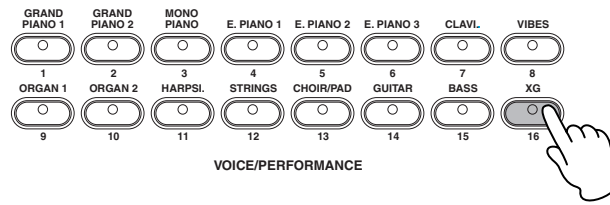

### 2-2 Simultaneously press the [-] [+] buttons located beside the XG Voice name display, to call up the display for selecting XG Voices.

In this case, press the A [-] [+] buttons simultaneously to call up the XG Voice selection display.

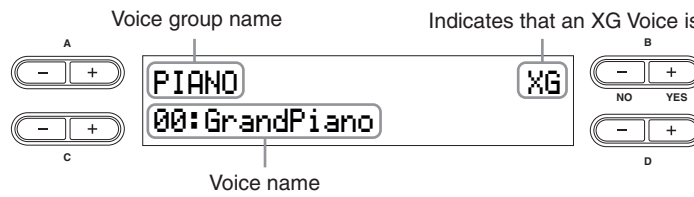

The XG Voice selection display can also be called up by pressing both the VARIATION [▼][▲] buttons simultaneously, after pressing the [XG] button.

### 2-3 Use the A [-] [+] buttons to select a Voice group.

### 2-4 Use the C [-] [+] buttons to select a specific Voice.

## 3 Play the keyboard.

## Playing Different Voices Simultaneously

The advanced features of the CP300 allow you to do things and perform in ways that are simply not possible on an acoustic instrument. For example, you can play several different Voices together in a layer, or play one Voice (or even two) layered Voices with your left hand while you play a different Voice (or two) layered Voices with your right.

You can make detailed settings for each Voice and combined Voice in Dual or Split. Refer to the “Detailed Settings for the Voices—Voice Edit” on page 56.

### Keyboard Part Combinations

The CP300 lets you effectively divide the keyboard into four independent parts: Main, Layer, Left and Left Layer. Moreover, a different Voice can be assigned to each part.

#### ■ Playing a Single Voice (Main part) (page 25)

You can play a single Voice over the entire keyboard range. This is used for normal performance.



#### ■ Playing Two Voices Simultaneously (Dual) (page 29)

This lets you play a unison melody with two different instruments, or combine two similar, complementary Voices to create a thicker sound.



#### ■ Playing Different Voices with Your Left and Right Hands (Split) (page 31)

This allows you to play different Voices with your left and right hands. For example, you can play a bass part with your left hand, using the Wood Bass or Electric Bass Voice, and a melody on top with your right hand.

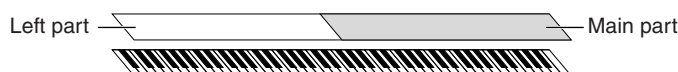

#### ■ Playing Three Different Voices with Your Left and Right Hands (Split and Dual for the Main parts) (pages 29, 31)

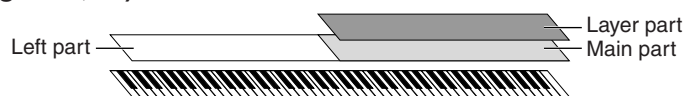

#### ■ Playing Three Different Voices with Your Left and Right Hands (Split and Dual for the Left parts) (page 31)

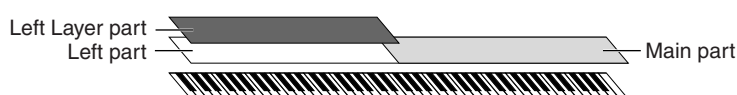

#### ■ Playing Four Different Voices with Your Left and Right Hands (Split and Dual) (page 30)

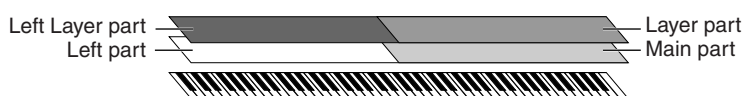

**NOTE** The volume level for each Voice part can be adjusted independently. For details, refer to page 28.

## Changing the Volume for Each Part (Zone Control)

The convenient [ZONE CONTROL] sliders allow you to adjust the volume of each part independently while you play the keyboard. Moving a slider up increases the volume while pulling the slider down decreases it.

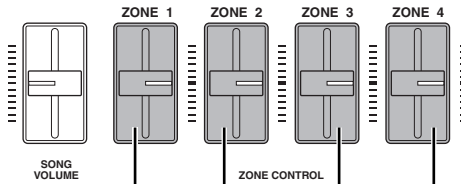
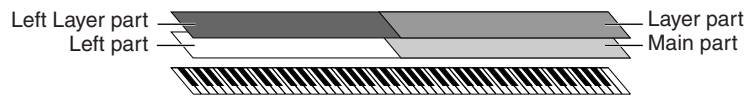

- ZONE 1: Main part
- ZONE 2: Left part
- ZONE 3: Layer part
- ZONE 4: Left Layer part

**NOTE** When you play a single Voice (Main part), you can adjust the volume by moving the [ZONE 1] slider. In this case, the [ZONE 2], [ZONE 3] and [ZONE 4] sliders have no effect on the volume.

Turning on the [MASTER] button switches the function assigned to the [ZONE CONTROL] sliders. Refer to the “Using the Master Mode” on page 39.

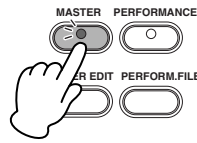

# Combining Voices—Dual

## Using Voices of Different Voice Groups—Dual

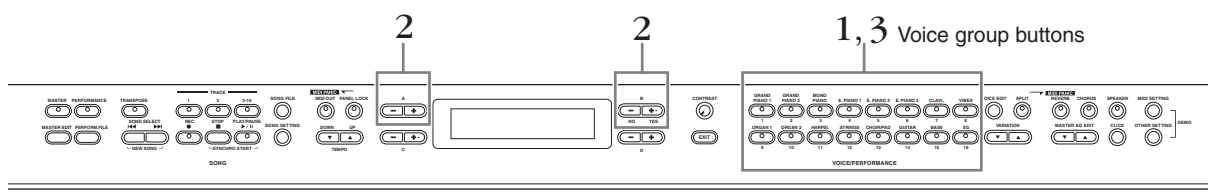

**NOTE** Make sure the [PERFORMANCE] button is turned off. For details about Performances, refer to page 73.

- 1 Press two Voice group buttons at the same time (or press one Voice group button while holding down another) to enable Dual.**

In this step, press the [GRAND PIANO 1] button and the [CHOIR/PAD] button. The [GRAND PIANO 1] button and [CHOIR/PAD] button light. The selected Voice name will appear in the display.

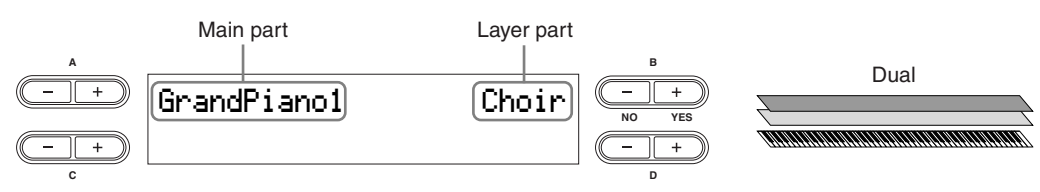

- 2 Select the particular Voice for each part by using the A [-][+] buttons and B [- (NO)][+ (YES)] buttons.**

You can also select the Main part Voice by using the VARIATION [▼][▲] buttons.

**NOTE** XG Voices can also be selected. For more information, refer to “About XG Voices” on page 26.

Select the “Honky Tonk Piano” Voice by using the A [-][+] buttons and select the “Scat” Voice by using the B [- (NO)][+ (YES)] buttons.

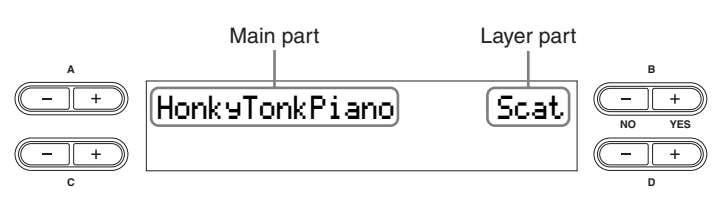

To select three parts—Main, Layer and Left—simultaneously hold down the [SPLIT] button and press the desired Voice group button.

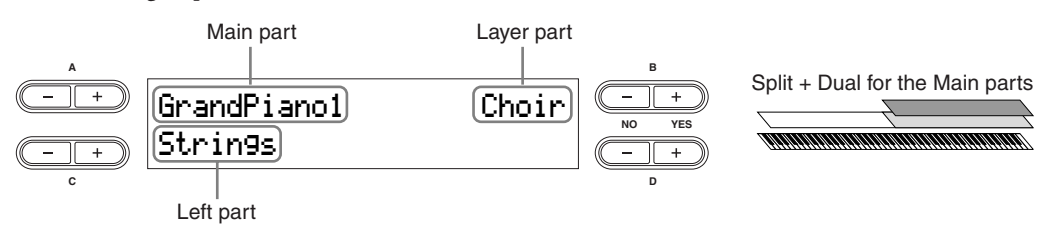

To select four parts—Main, Layer, Left and Left Layer—simultaneously hold down the [SPLIT] button and press two Voice group buttons.

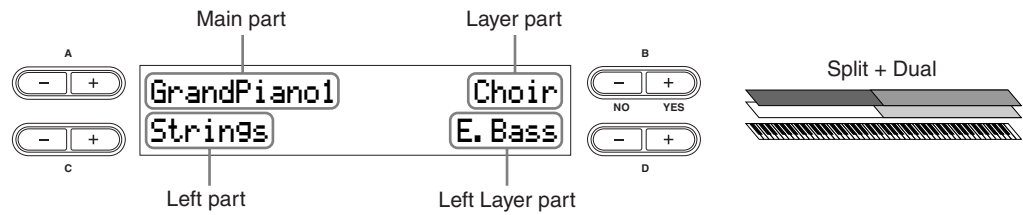

You can select other Voices by using the A – D letter buttons (A [-][+] to D [-][+]).

**NOTE** For details about the Split function, refer to page 31.

### 3 Press any single Voice group button to exit Dual and return to normal play.

## Using Voices in the Same Voice Group—Dual

Dual can also be used to select and play Voices in the same Voice group.

### 1 Press one of the Voice group buttons.

### 2 Use the A [-][+] buttons to select the desired Voice.

You can also select the Main part Voice by pressing the VARIATION [▼][▲] buttons.

### 3 Use the B [- (NO)][+ (YES)] buttons to select another Voice in the same Voice group.

To use identical Voices, press the B [- (NO)][+ (YES)] buttons once.

To use different Voices within the same Voice group, press the B [- (NO)][+ (YES)] buttons repeatedly.



## Playing Different Voices with the Left and Right Hands—Split

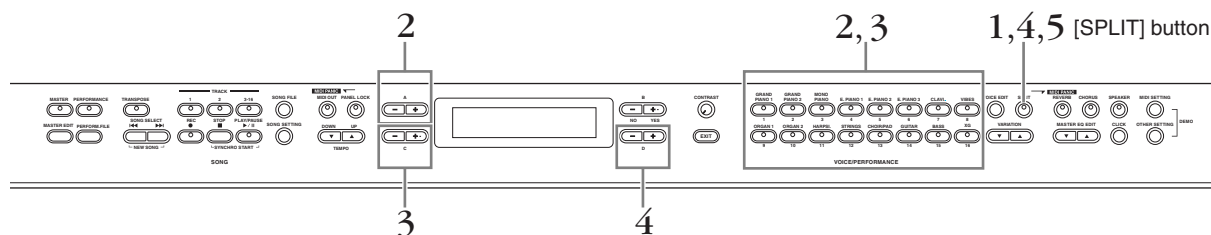

- 1 Press the [SPLIT] button to enable Split.**  
The [SPLIT] button lights.
- 2 Select a Voice for the right-hand area by pressing one of the Voice group buttons.**  
In this step, press the [GRAND PIANO 1] button.  
Use the A [-][+] buttons to select the “Honky Tonk Piano” Voice.
- 3 Select a Voice for the left-hand area by simultaneously holding down the [SPLIT] button and pressing one of the Voice group buttons.**  
In this step, press the [CHOIR/PAD] button.  
Use the C [-][+] buttons to select the “Scat” Voice.

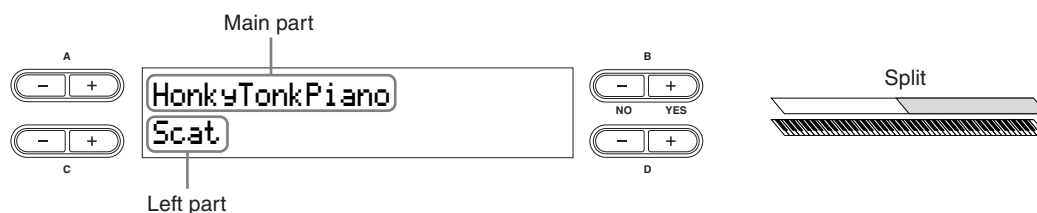

To divide the keyboard into Main, Layer and Left parts, press two Voice group buttons at the same time (or press one Voice group button while holding down another).

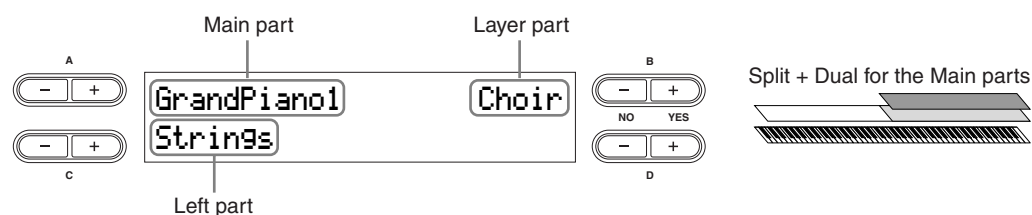

To divide the keyboard into Main, Layer and Left Layer parts, simultaneously hold down the [SPLIT] button and press two Voice group buttons.

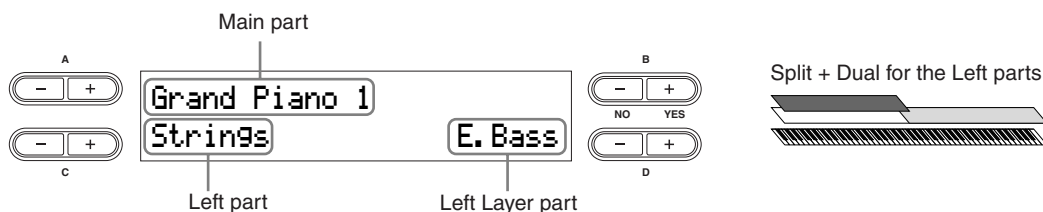

To divide the keyboard into four parts—Main, Layer, Left and Left Layer—perform both the above operations (last two sentences) in order.

## 4 Specify the split point (the border between the right- and left-hand range).

The default setting (factory setting) is “F#2.” (If you do not need to change the split point, skip this step.)

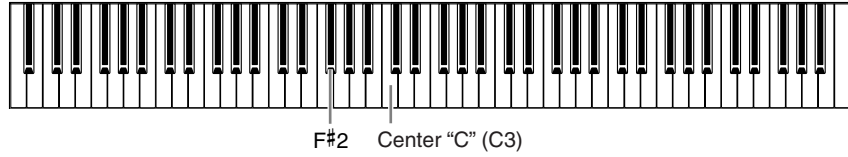

### To Change the Split Point Setting

#### 4-1 Simultaneously hold down the [SPLIT] button and use the D [-][+] buttons to specify the split point.

There is also a quicker, more intuitive way: instead of using the D [-][+] buttons, simultaneously hold down the [SPLIT] button and press the appropriate key on the keyboard.

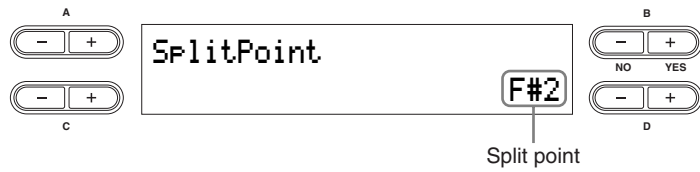

**NOTE** The Main part and Layer part of the split point are specified simultaneously. If you wish to independently change the split point for each part, you can call up the Other Settings menu and use the “Split Point” parameter to set the Main part split point and use “Split Point 2” to set that of the Layer part (page 69).

#### 4-2 Release the [SPLIT] button to return to the main display.

## 5 Press the [SPLIT] button to exit Split and return to normal play.

## Using the Pedals

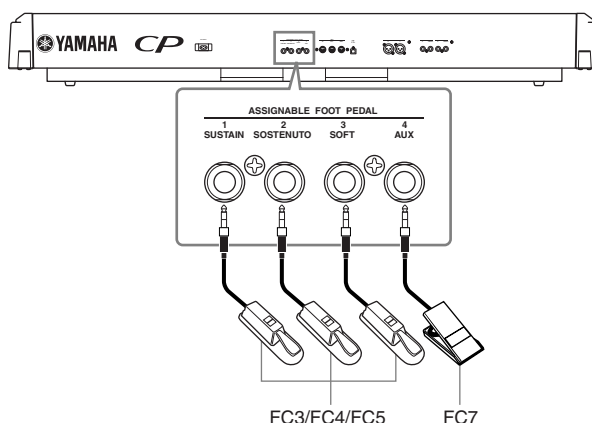

### ⚠ CAUTION

Make sure that the power is off when connecting or disconnecting any pedal.

- NOTE**
- By connecting a pedal to the [ASSIGNABLE FOOT PEDAL] jack, you can use the pedal to control one of various assignable functions. Refer to the “Pedal 1/Pedal 2/Pedal 3/Pedal 4” parameter in the Voice Edit menu (pages 61, 62).
  - Depending upon the pedal that is connected to the [ASSIGNABLE FOOT PEDAL] connector, the effect produced by operating the pedal (on/off, dynamics, etc.) might be reversed. Refer to the “Pedal Type” parameter in the Other Settings menu (page 70).
  - The function of the [PLAY/PAUSE] button can be assigned to the pedal connected to the [2 SOSTENUTO]/[3 SOFT]/[4 AUX] jacks. Refer to the “Pedal Play/Pause” parameter in the Other Settings menu (page 70).

The [ASSIGNABLE FOOT PEDAL] jack is set initially for use with the following functions (factory default setting).

### Sustain Pedal (1 SUSTAIN jack)

This jack is for connecting the included FC3 foot pedal. The pedal functions in the same way as a damper pedal on an acoustic piano. Connect the included pedal (FC3) to this jack and press the pedal to sustain the sound. When Voices of the GRAND PIANO 1 Voice group and the Mono Piano 1 and Comp. Piano 1 Voices are selected, pressing the FC3 pedal activates the instrument’s special Sustain Samples, which accurately recreate the unique resonance of an acoustic grand piano’s soundboard and strings. The FC3 can also be used to control the half pedal effect on these Voices, recreating the partial damping of strings that is possible on an actual piano. An optional FC4/FC5 foot switch can also be connected to this jack. However, these foot switches cannot be used to control the half pedal effect.

**NOTE** The depth of the effect produced by the Sustain Samples can be adjusted via the “Sustain Sampling Depth” parameter in the Other Settings menu (page 69).

### Sostenuto Pedal (2 SOSTENUTO jack)

This jack is for connecting an included foot pedal FC3 and an optional FC3/FC4/FC5 foot switch. If you play a note or chord on the keyboard and press the sostenuto pedal while holding the note(s), the notes will sustain as long as the pedal is held. This makes it possible to sustain a chord, for example, while other notes are played “staccato.”

**NOTE** Organ, string and choir Voices will continue to sound for as long as the sostenuto pedal is depressed.

### Soft Pedal (3 SOFT jack)

This jack is for connecting an included foot pedal FC3 and an optional FC3/FC4/FC5 foot switch. The soft pedal reduces the volume and slightly changes the timbre of notes played while the pedal is pressed. The soft pedal will not affect notes that are already playing.

**NOTE** The depth of the Soft pedal can be adjusted via the “Soft Pedal Depth” parameter in the Other Settings menu (page 69).

### AUX Pedal (4 AUX jack)

This jack is for connecting an optional FC7 foot controller.

This AUX Pedal can be assigned to control a variety of parameters on the instrument. Refer to the “Pedal 4” parameter in the Voice Edit menu (page 62).

## Bending Notes—Pitch Bend Wheel

Use the Pitch Bend wheel to bend notes up (roll the wheel away from you) or down (roll the wheel toward you) while playing the keyboard. This wheel is self-centering and will automatically return to normal pitch when released. Try out the Pitch Bend wheel while pressing a note on the keyboard.

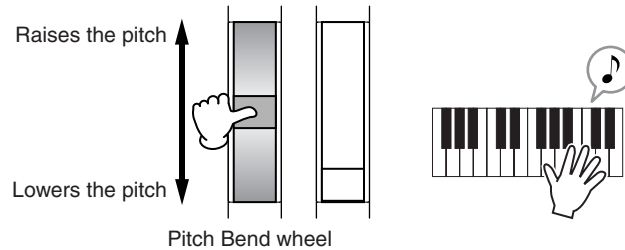

**NOTE** The bend range can be adjusted via the “Pitch Bend Range” parameter in the Other Settings menu (page 70).

## Adding a Vibrato Effect to the Sound—Modulation Wheel

The Modulation wheel applies vibrato to the sound. The more you move this wheel up, the greater the effect that is applied to the sound. Try out the Modulation wheel with various Preset Voices while playing the keyboard.

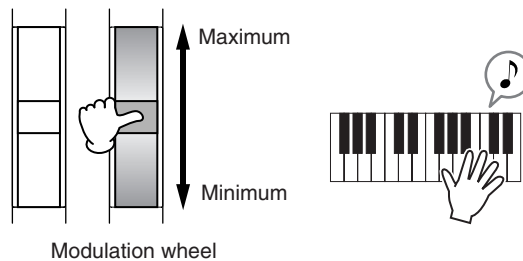

**NOTE** Keep in mind that many of the Preset Voices are not set with a Modulation effect. (This is to ensure the most natural sound on these acoustic instrument Voices.) However, the Modulation wheel can be effectively used to control user-programmable effects, as well as alter the sounds of a connected MIDI tone generator.

**NOTE** Various functions can be assigned to the Modulation Wheel. Refer to the “Modulation” parameter in the Voice Edit menu (page 62).

**NOTE** To avoid accidentally applying Modulation or other effects to the current Voice, make sure the Modulation Wheel is set to minimum before you start playing.

## Enhancing the Sound with Reverb and Chorus

The effect processing of the CP300 features both System Effects and Insertion Effects.

### System Effects—Reverb and Chorus

System Effects are applied to the overall sound, whether it be a Voice, an entire Performance, a Song, etc. Each part can be given a different amount of System Effect processing.

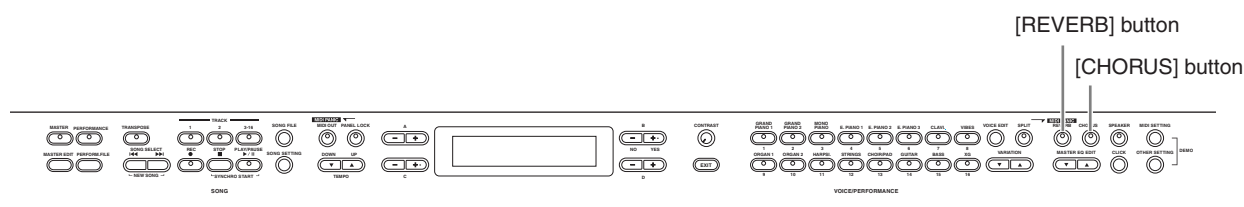

#### Reverb

The reverb effects add a warm ambience to the sound, simulating the complex reflections of actual performance spaces, such as a concert hall or small club.

Refer to “Effect Type List” on page 114 for more information on the preset reverb types.

Pressing the [REVERB] button alternates between On and Off.

The indicator lights if reverb is turned on.

**NOTE** You can select a reverb type via the “Reverb Type” parameter in the Voice Edit menu, and adjust the reverb depth for the selected Voice via the “Reverb Send” parameter (page 58).

**NOTE** Even if the reverb effect is turned off, a “soundboard reverb” effect will be applied for these Voices: GRAND PIANO 1, GRAND PIANO 2 Voice groups and Mono Piano 1, Mono Piano 2, Marimba and Celesta Voices.

#### Chorus

The chorus effects use various types of modulation processing, including flanger and phaser, to enhance the sound in a variety of ways.

Refer to “Effect Type List” on page 114 for more information on the preset chorus types.

Pressing the [CHORUS] button alternates between On and Off.

The indicator lights if chorus is turned on.

You can turn the chorus effect on and off by pressing the [CHORUS] button on the panel and by setting the “Chorus On Off” parameter in the Voice Edit menu (page 59). The [CHORUS] button setting on the panel is temporary. That is, if you select another Voice, the chorus setting for the previous Voice is cancelled.

The “Chorus On Off” parameter setting is saved for each Voice. That is, if you select a given Voice, the chorus setting is automatically turned on or off according to the saved chorus setting.

**NOTE** You can select a chorus type via the “Chorus Type” parameter in the Voice Edit menu and adjust the chorus depth for the selected Voice via the “Chorus Send” parameter (page 59). You can also turn chorus on or off via the “Chorus On Off” parameter (page 59).

### Insertion Effects

Insertion effects can be applied individually to each part. Insertion effects are mainly used to directly process a single part. The CP300 has three separate Insertion Effect blocks, letting you apply different effects on up to three parts from Main, Layer, Left and Left Layer parts (page 27).

**NOTE** You can select an Insertion type via the “Ins. Type” parameter in the Voice Edit menu, and adjust the Insertion effect depth for the selected part via the “Dry/Wet Balance” parameter (pages 59, 60).

The CP300 also has a Variation effect that can be used as either a System effect or Insertion effect. Refer to “Effect Type List” on page 114 for more information on the types of effects you can use. The Variation effect can be controlled only by the use of MIDI messages.

## Equalizer (EQ)

Usually an equalizer is used to correct the sound output from amps or speakers to match the special character of the room, or to change the tonal character of the sound. EQ divides the sound into several frequency bands, and adjustments are made by raising or lowering the level of each band.

By adjusting the sound according to the genre—classical music being more refined, pop music more crisp, and rock music more dynamic—you can draw out the special characteristics of the music and make your performance more enjoyable.

Two separate EQ sections are available on the instrument: Part EQ and Master EQ.

### Part EQ

The Part EQ is applied to each Voice.

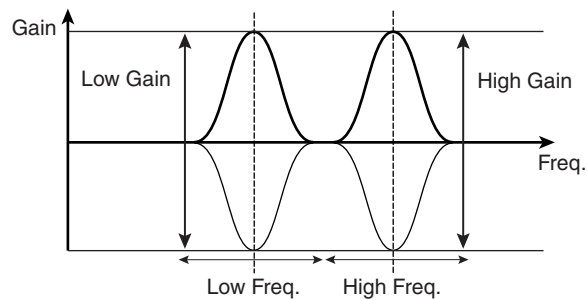

**NOTE** You can adjust the part's low and high frequency via the "EQ Low Freq." and "EQ High Freq." parameter in the Voice Edit menu. You can also adjust the part's low- and high-range gain via the "EQ Low Gain" and "EQ High Gain" parameters (pages 60, 61).

### Master EQ

Master EQ is applied to the final, overall (post-effect) sound of the instrument. When the corresponding slider is set to center, the equalizer level is set to normal.

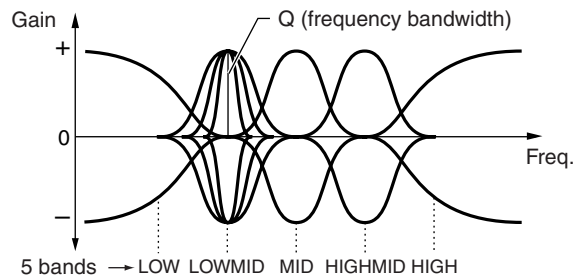

**NOTE** You can adjust the Q (frequency bandwidth) and Frequency parameters via the Master EQ Edit menu (page 72). However, the last gain setting by the slider or Master EQ Edit menu will remain in effect.

**NOTE** While the "Equalizer Lock" parameter (page 71) in the Other Settings menu is turned on, the Master Equalizer values will not be affected by Performance recall, incoming MIDI data and Song playback.

## Key Transposition—Transpose

The CP300's Transpose function makes it possible to shift the pitch of the entire keyboard up or down in semitone intervals to facilitate playing in difficult key signatures, and to let you easily match the pitch of the keyboard to the range of a singer or other instruments. For example, if you set the transposition amount to “+5,” playing a C key produces a pitch of F. In this way, you can play a Song as though it were in C major, and the CP300 will transpose it to the key of F.

Press the [TRANSPOSE] button to transpose the entire keyboard. With just the press of a button, you can reconfigure the transpose setting. For details about setting the amount of transposition, see below. The indicator will light when a transpose setting other than “0” is selected.

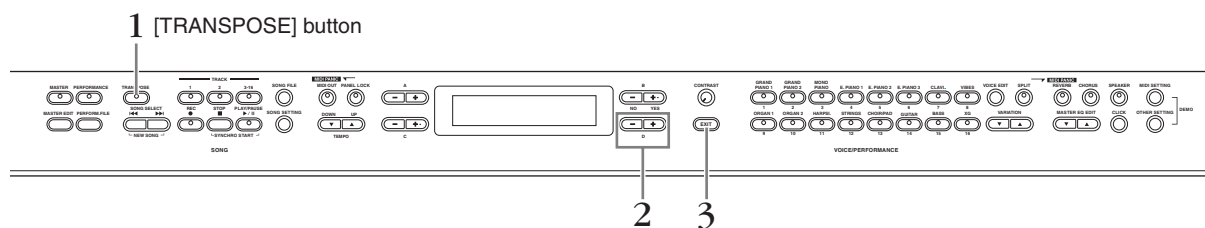

### 1 Press the [TRANSPOSE] button.

The amount of transposition in semitone units appears in the display.

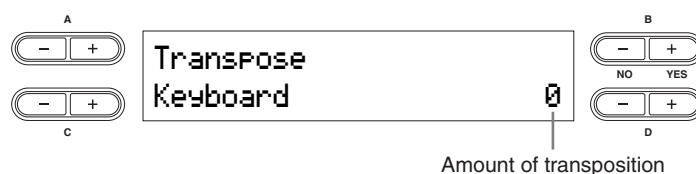

### 2 Press the D [-][+] button to transpose down or up as required.

You can set the range from -12 semitones (down one octave) to 12 semitones (up one octave) in semitone steps.

Transposing shifts the pitch of the entire keyboard.

#### The transposition range:

-12: -12 semitones (down one octave), 0: normal pitch, 12: 12 semitones (up one octave)

**NOTE** You can set the keyboard's Transpose via the “Transpose” parameter in the Other Settings menu, when the [TRANSPOSE] button is turned on (page 69).

**NOTE** The Transpose setting affects transmitted MIDI data.

### 3 Press the [EXIT] button to exit the Transpose setting.

**NOTE** The edited Transpose settings will be erased after you turn off the power to the CP300. If you set the Memory Backup's Transpose setting to On in the Other Settings menu, the current Transpose setting will remain in effect when you turn the power off and back on again (page 71).

# Using the Click

Pressing the [CLICK] button turns Click or the metronome sound on and off.

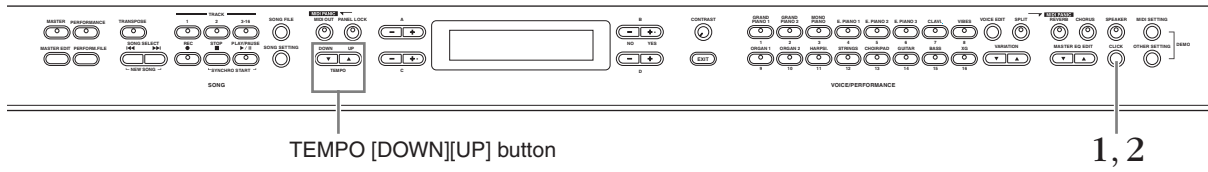

## 1 Press the [CLICK] button to start the click.

### Adjusting the Tempo

#### 1-1 Press the TEMPO [DOWN] or [UP] button.

The “Tempo” parameter will appear in the display.

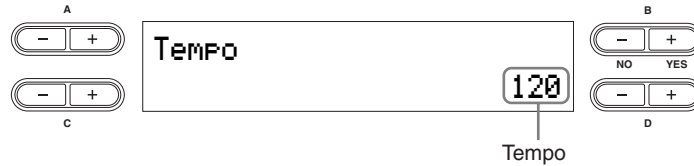

To adjust the tempo (number of beats per minute: 10-500), use the TEMPO [DOWN][UP] or the D [-][+] buttons.

To reset the tempo to the default setting, press the TEMPO [DOWN][UP] or the D [-][+] buttons simultaneously.

**Default setting:** 120 (If a Song has been selected, the Song tempo is used.)

#### 1-2 Press the [EXIT] button to go back to the Main display.

## 2 Press the [CLICK] button to stop the click sound.

**NOTE** You can change the time signature, volume, and bell on/off settings using the Song Setting menu (page 87).

**NOTE** The click will not start after the Song is stopped. If you wish to start the click, press the [CLICK] button again.

**NOTE** The click will stop when Song playback is paused.



# Using the Master Mode

The Master mode allows you to divide the keyboard into a total of four independent areas (called “Zones”). Each Zone can be assigned to different MIDI channels and have different Control Slider functions. This makes it possible to control up to four tone generators simultaneously from a single keyboard, and to control Voices of an external tone generator over several different channels, in addition to the internal Voices of the CP300 itself.

Press the [MASTER] button to turn the Master mode on.

Turning on the Master mode also enables the “Master Edit” settings for this function.

For details, refer to page 53.

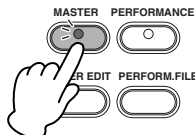

## Example: Connecting to external tone generators

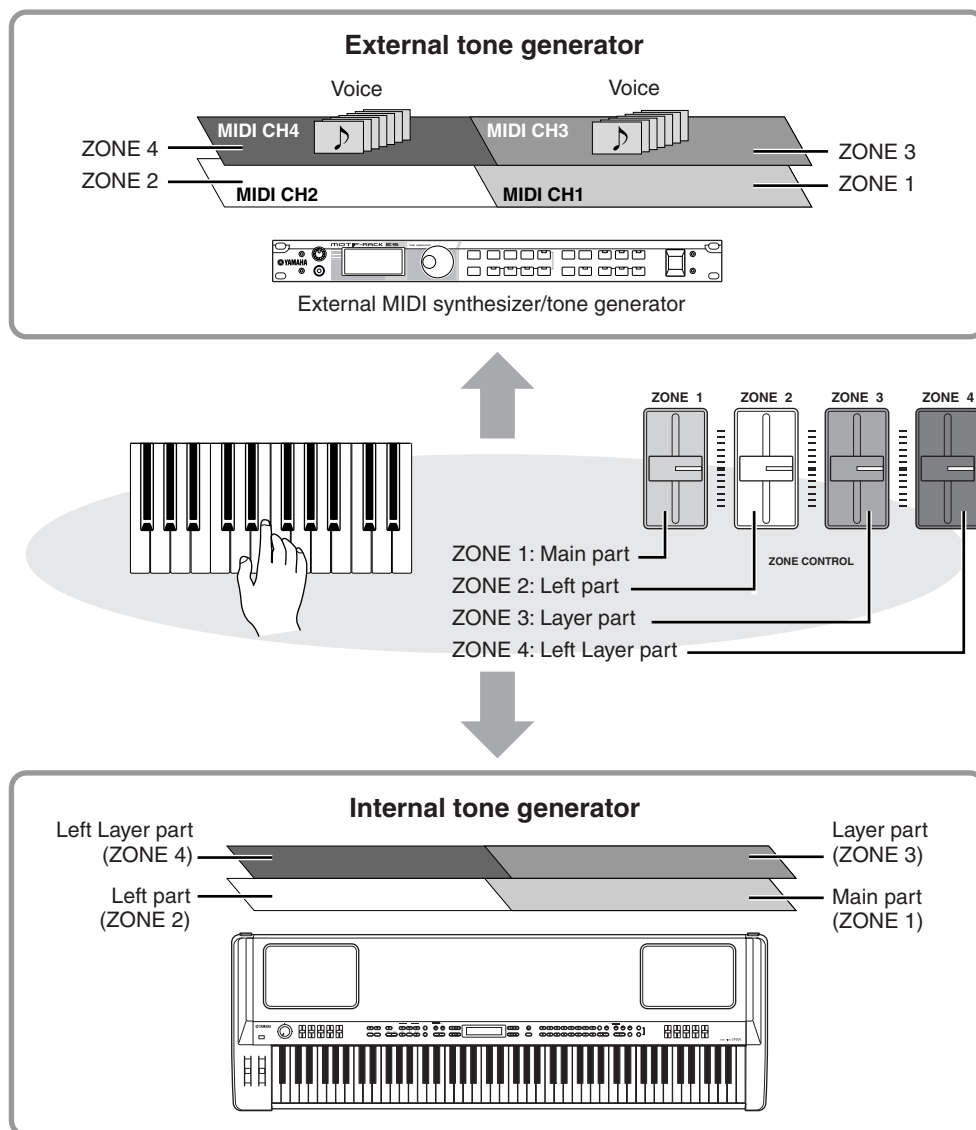

**NOTE** While the Master mode is turned on, the “MIDI Out Channel” parameter in the Master Edit menu will be enabled for MIDI channel assignments.

**NOTE** If you turn the power off and on again while the Master mode is on, the function will be turned off.

# Selecting a Performance

All settings of the entire CP300 can be saved together in a group, referred to as a “Performance.” A Performance includes Dual/Split settings, Voice and effect parameters, MIDI transmit/receive channel settings and Master Edit settings. For details on Performance settings, refer to page 73.

A total of 64 Preset Performances are supplied with the CP300. The Preset Performances consist of 32 Yamaha original Voices and 32 default Performances (Grand Piano Voices). Try some of the Preset Performances and listen to the sound.

## Terminology

**Preset Performance file:** A single file that includes data of 64 different Preset Performances.

**NOTE** Refer to the “Preset Performance List” on page 106 for more information on the characteristics of each Preset Performance.

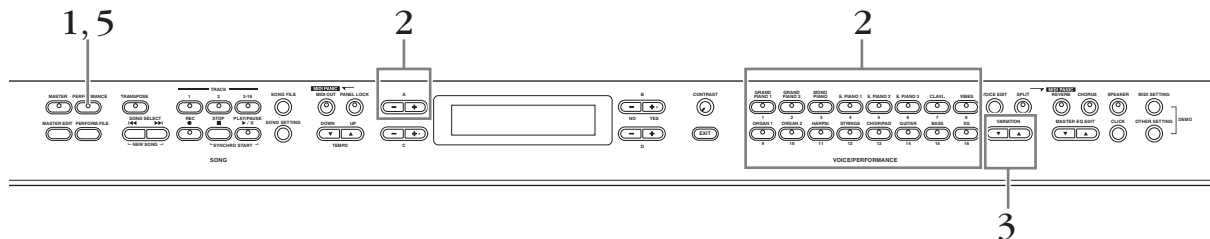

**1** Press the [PERFORMANCE] button to enter the Performance mode.  
The [PERFORMANCE] button flashes.

**2** Choose a Performance by pressing one of the Voice group buttons.  
Playing the keyboard sounds the Performance indicated in the display. The parameters shown in the Performance Play display are briefly explained below.

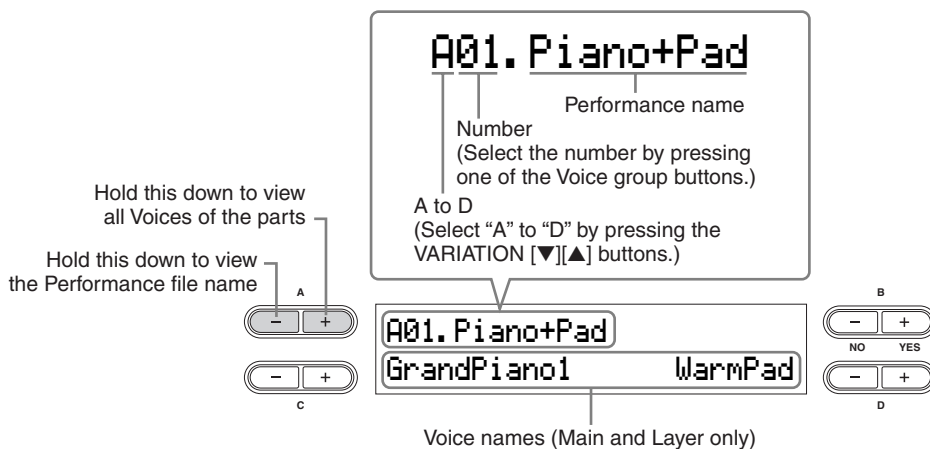

**3** Press the VARIATION [▼][▲] buttons to select one of the Performance variations, A to D.

A single Performance can include up to four different Performances (A to D). “A” and “B” features the Yamaha original Voices. “C” and “D” contains the default Performances (Grand Piano Voices).

**4** Play the keyboard.

**5** Press the [PERFORMANCE] button to exit the Performance Play mode.

The [PERFORMANCE] button lamp turns off. The Voice selection will return to the Voice selected before entering the Performance.

You can exit the Performance yet keep the current Voice used in the Performance by simultaneously holding down the B [– (NO)] button and pressing the [PERFORMANCE] button.

# Recording Your Performance

This chapter explains how to record your performance using the CP300's versatile recording features. For example, you can record just the left-hand part, and then practice the right-hand part while playing back the recorded left-hand part. Since the CP300 lets you record up to sixteen tracks separately, you can build up a complete, multi-instrument Song by recording each part one-by-one.

## About the Recording Features of the CP300

Unlike conventional audio recording (such as to an MD recorder or cassette tape recorder), the CP300 records your keyboard playing as performance data. In other words, while an MD records the actual sounds, the CP300 records the physical “moves” and settings that create the sound—including which notes are played, the timing they were played with, the Voice(s) used, and the tempo value. This type of recording has the advantage of allowing you greater editing flexibility and smaller data size.

**NOTE** If you want to record the sounds of your performance as audio data, you can do so by connecting an MD recorder or other recording device to the [OUTPUT] connector (page 88).

## Song

On the CP300, performance data is called a “Song.” This includes demonstration tunes and preset tunes.

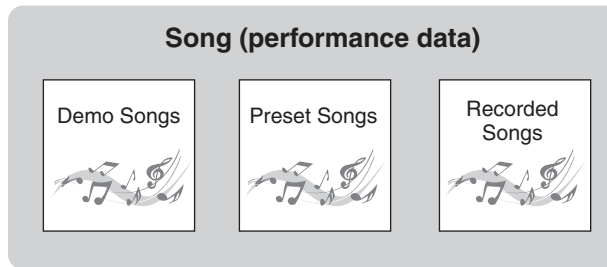

# Recording Your Performance

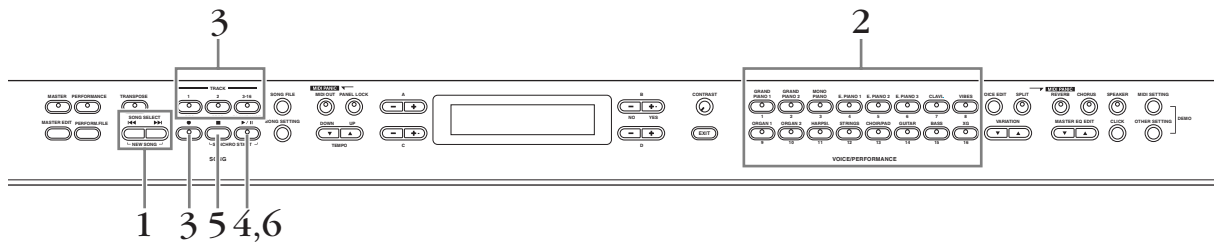

**NOTE** The Performance mode is automatically turned off if the CP300 is set to recording or recording standby while Performance mode is on.

## 1 Press the SONG SELECT [◀◀] button and [▶▶] button at the same time.

Indicates the current measure.  
(The words “bar” and “measure” are used interchangeably.)

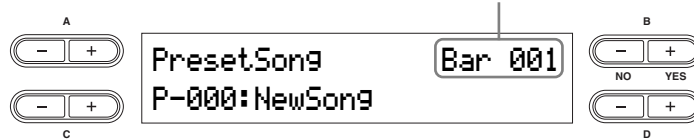

**NOTE** “P-000: New Song” is a blank Song provided for you to record your performance.

## 2 Select a Voice (page 25).

In addition to selecting the desired Voice, make sure to set other sound-related parameters, such as reverb and chorus. When you’ve finished making the settings, press the SONG SELECT [◀◀] or [▶▶] button to return to the “New Song” display.

### Using the Click Sound

You can record data while using the Click sound. Press the [CLICK] button in Step 2.  
The Click sound is not recorded.

**NOTE** Refer to page 48 for more information on recording in Dual/Split mode.

## 3 Select a recording track.

### Recording to Track 1:

Press the TRACK [1] button while holding down the [REC] button.

### Recording to Track 2:

Press the TRACK [2] button while holding down the [REC] button.

### Recording to Tracks 3 – 16:

Press the B [- (NO)] [+ (YES)] button while holding down the [REC] button, then select the desired recording track, 3 – 16. Keep holding down the [REC] button and press the TRACK [3-16] button.

When the recording track has been selected, the indicator for the [REC] button and selected track lights up in red. (Record Ready mode can be disengaged before recording by pressing the [REC] button again.)

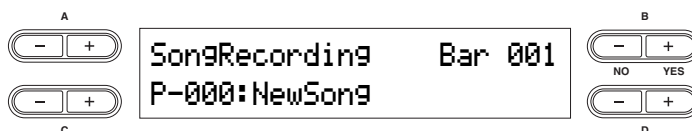

Set the Tempo, if necessary (page 38).

If this Record Standby display does not appear, press one of the SONG SELECT [◀◀][▶▶] buttons once. If you select “Key On” as the Starting method (page 44), a Tempo setting of 120 will be entered at the beginning of the Song.

#### 4 Start recording.

You can start recording by pressing the [PLAY/PAUSE] button, or have recording started automatically for you as soon as you play a note on the keyboard. The current measure number is shown in the display during recording.

**NOTE** Song recording can be paused by pressing the [PLAY/PAUSE] button. Recording will begin automatically as soon as you play a note on the keyboard or press the [PLAY/PAUSE] button again.

#### 5 Press either [STOP] button or [REC] button to stop recording.

Press the [STOP] button to return to the top of the Song.

#### 6 Press the [PLAY/PAUSE] button to play back the recording.

**NOTE** To erase recorded data from a track, use the “Channel Clear” parameter in the Song Setting menu for Song playback/recording (page 86).

#### 7 Save the recorded Song

When pressing the SONG SELECT [◀◀][▶▶] button, A [-][+] button or C [-][+] button, a “Song Changed Save?” message appears in the display. Press the B [+ (YES)] button to save the file. If you want to cancel the Save operation, press the B [- (NO)] button. For details about saving Song files, refer to page 82.

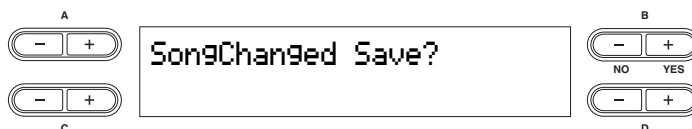

# Re-recording Parts of a Song

This section explains how to record a specific section or part of a Song again.

- 1 Use the B [- (NO)][+ (YES)] buttons while the playback display is displayed to move through the measures, or play back the recording and press the [PLAY/PAUSE] button to locate a point slightly prior to the beginning of the part you wish to re-record.

If the playback display does not appear, press one of the SONG SELECT [◀◀][▶▶] buttons once.

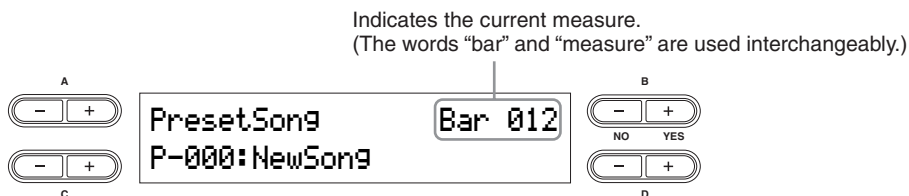

- 2 Select a Voice or Voices for recording, if necessary.

Repeat Step 2 on page 42 if you wish to change the previous settings.

- 3 Press and hold down the [REC] button, and press one of the C [-][+] buttons repeatedly to specify how the recording should start. Similarly, use the D [-][+] buttons to specify how the recording should end.

While you are holding down the [REC] button, the following recording method select display appears.

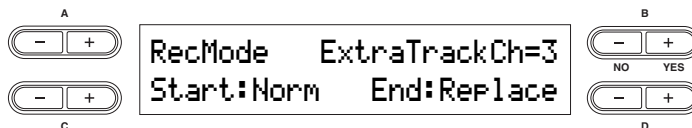

**Starting methods:**

**Norm:** All existing data in the Song will be erased after re-recording starts.

**Key On:** Data that exists prior to the point where you start playing a note will not be erased (when re-recording part of the Song).

**Ending methods:**

**Replace:** Existing data following the point at which you stopped recording will be erased.

**Punch Out:** Existing data following the point at which you stopped recording will remain.

- 4 Select a recording track, then start recording.

After this, follow the procedure beginning with Step 3 on page 42.

## Data Recorded to User Songs

---

### Data recorded to individual tracks:

- Notes played
- Voice selection
- Pitch Bend
- Pedal/Modulation wheel ON/OFF
- Reverb depth (Reverb Send)
- Chorus depth (Chorus Send)
- Insertion effect depth (Dry/Wet Balance)
- Sound brightness (Brightness)
- Resonance effect setting (Harmonic Content)
- Equalizer's low-range frequency setting (EQ Low Freq.)
- Equalizer's low-range gain setting (EQ Low Gain)
- Equalizer's high-range frequency setting (EQ High Freq.)
- Equalizer's high-range gain setting (EQ High Gain)
- Voice octave setting (Octave)
- Voice volume level (Volume)
- Stereo image of each Voice (Pan)
- Fine tuning of the pitch of two Voices in Dual mode (Detune)
- Volume level changes for each Voice with response to the way you play (Touch Sense)
- Voice Transpose (Transpose)
- Scale (Scale)
- Depth of Soft pedal effect (Soft Pedal Depth)
- Depth of string resonance (String Resonance Depth)
- Depth of sustain sampling (Sustain Sampling Depth)
- Volume of the key-off sound (Key-off Sampling Depth)
- Modulation (Modulation)
- Pitch Bend range (Pitch Bend Range)

### Data recorded globally to all tracks:

- Tempo
- Time signature (beat)
- Reverb type
- Chorus type
- Insertion effect type

**NOTE** You can change any of the settings with the exception of note data (including the Octave and Transpose setting) after recording.

**NOTE** You can change the time signature at the beginning of the Song, or at a specific position in the Song, by using the B [- (NO)][+ (YES)] buttons while the Song is stopped.

**NOTE** When you record in the Dual or Split mode, the CP300 records each Voice onto a separate track. For details, refer to page 48.

## Other Recording Techniques

### Adding Data to or Recording Over an Existing Song

The previous section explains how to record your performance from the beginning by selecting a blank Song (P-000: New Song). You can also add new performance recordings to existing Songs, or overwrite your previously recorded performances.

- 1 Press one of the SONG SELECT [◀◀][▶▶] button then use the A [-][+] button to call up “Memory Song.”

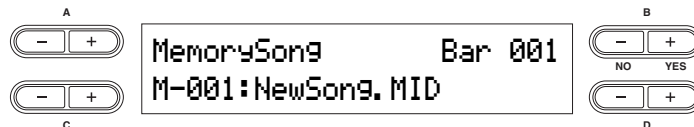

- 2 Press the C [-][+] button to select the Song you wish to add data to or record over. You cannot add data to or record over Preset Songs.

To continue recording, follow the procedure described in “Recording Your Performance” on page 42. To add data to an existing Song, follow the procedure starting with Step 1 in “Re-recording Parts of a Song” on page 44.

#### CAUTION

If you record on a track that already has data, the existing data on the track will be lost.

### Changing a Voice or Tempo After Recording

You can change the Voice or tempo after recording to change a Song’s feel or to set a more suitable tempo. You can also change these elements in the middle of a Song.

**NOTE** Before changing the Voice or tempo, set the starting method to “Norm” (page 44). When the starting method is set to “Key On,” you cannot change the Voice or tempo.

- 1 **Select a Song you wish to change.**  
To select a Song, follow the procedure described in “Adding Data to or Recording Over an Existing Song” above.
- 2 **To change the Voice or tempo in the middle of the Song, specify the measure at which the change is to be made by using the B [- (NO)][+ (YES)] buttons while the playback display is appeared, or by pressing the [PLAY/PAUSE] button to locate a point slightly prior to the beginning of the part you wish to re-record.**  
If the playback display does not appear, press one of the SONG SELECT [◀◀][▶▶] buttons once.



### 3 Change the settings (Voice, reverb, etc.).

For example, if you wish to change the recorded E. Piano 1 Voice to E. Piano 2, use the Voice group buttons and the A [-][+] buttons to select E. Piano 2.

When you've finished making the settings, press one of the SONG SELECT [◀◀][▶▶] button to return to the Song Select display.

#### ⚠ CAUTION

The panel settings made in Step 3 will be saved in memory and you will not be able to restore the previous settings. Proceed with caution.

### 4 Simultaneously hold down the [REC] button and select a track to change the value.

The indicator for the selected part lights up in red. Change the tempo setting now, if necessary.

#### ⚠ CAUTION

Do not play the keyboard or press the [PLAY/PAUSE] button. Doing so will start recording, erasing the recorded data.

### 5 Press the [STOP] or [REC] button to exit the record mode.

When you exit the record mode, the display prompts you whether you want to overwrite the Song or not. Press the B [+ (YES)] button to overwrite the Song.

**NOTE** Refer to “Data Recorded to User Songs” on page 45 for information on the settings that can be changed here.

## Adjusting the Volume Balance between the Song and the Keyboard

While recording multiple parts one-by-one, you can adjust the volume balance between the playback of the recorded parts and your current performance by using the [SONG VOLUME] slider.

Turning off the [MASTER] button lets you adjust the volume for the keyboard performance by using the [ZONE CONTROL] sliders.

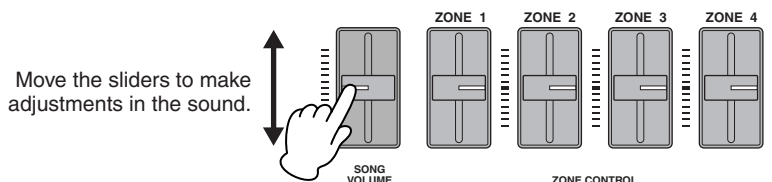

## Recording in Dual or Split Mode

When you record in Dual or Split mode, the CP300 records each Voice onto a separate track. The following table shows how tracks are assigned to each Voice.

### CAUTION

When you record multiple parts into tracks one-by-one, or when you record new data over an existing Song (page 46), the existing data will be erased. Proceed with caution.

In the following example, Tracks 1, 2, and Extra Track “n” have been selected for recording.

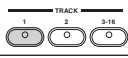
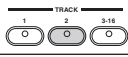
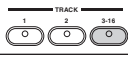
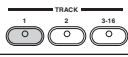
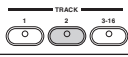
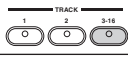
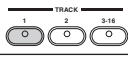
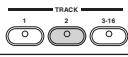
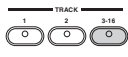
Panel	Assigned recording track	Track 1	Track 2	Extra Track 3	Extra Track 4	Extra Track 5	Extra Track 6	...	Extra Track 16
Dual		Main part		Layer part					
			Main part		Layer part				
				Main part (Track n)		Layer part (Track n+2)			
Split		Main part	Left part						
		Main part	Left part						
				Main part (Track n)	Left part (Track n+1)				
Dual+Split		Main part	Left part	Main Layer part	Left Layer part				
		Main part	Left part	Main Layer part	Left Layer part				
				Main part (Track n)	Left part (Track n+1)	Main Layer part (Track n+2)	Left Layer part (Track n+3)		

Track n = Track 3 to 16

If “n+1,” “n+2,” and “n+3” exceeds 16, Tracks 1, 2, and 3 are used.

**NOTE** Changing between Dual and Split mode in the middle of a Song cannot be recorded.

# Song Playback

Songs you've recorded using the Record function (page 41) as well as Preset Songs can be played back on the CP300. You can also play the keyboard along with Song playback.

## Playing Back a Song

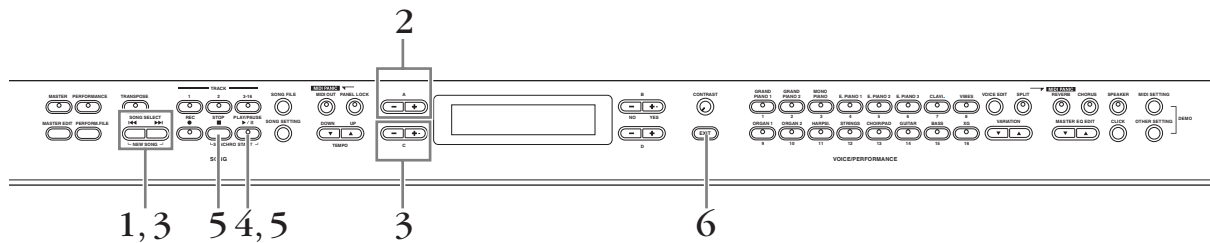

**1** Press one of the **SONG SELECT** [**◀◀**][**▶▶**] buttons to call up the Song Select display.

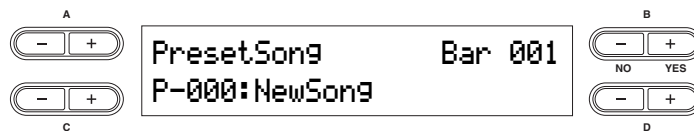

**2** Select “Preset Song” or “Memory Song” by using the **A** [**-**][**+**] buttons. The indication “Memory Song” can be called up when your Song data exists in internal storage memory.

### Terminology

**Preset:** Preset Song Memory. Several Preset Songs (16 Songs) are built into this instrument.

**Memory:** Refers to the memory storage location for saving recorded data on this instrument.

**3** Select the desired Song by using the **C** [**-**][**+**] buttons or **SONG SELECT** [**◀◀**][**▶▶**] buttons.

Use the **D** [**-**][**+**] buttons to scroll through the Song name, if the name does not fit in the display.

**4** Press the [**PLAY/PAUSE**] button to start playback.

- NOTE**
- Use the “Song Repeat” parameter in the Song Setting menu (page 87) to select repeat playback of all Songs or repeat playback of a single Song.
  - You can use the **TEMPO** [**DOWN**][**UP**] buttons to adjust the playback tempo as required before or during playback (page 38).
  - When the “Character Code” setting is different than that used when you named the Song, the title might be displayed incorrectly. Change the CP300’s character type (“Character Code”) to that appropriate for the selected Song (page 84).

**5** Stop playback.

When playback is complete, the Song automatically stops and the CP300 returns to the top of the Song. If you wish to stop playback in the middle of a Song, press the [**STOP**] button. Song playback can be paused by pressing the [**PLAY/PAUSE**] button.

**6** Press the [**EXIT**] button to go back to the Main display.

## Fast Forward and Rewind

The following operations can be performed in the Song select display:

- Use the B [- (NO)][+ (YES)] buttons to move back and forth (rewind and fast forward) through the Song while the Song is played or stopped.
- Press the C [-] button during playback to locate the top of the current Song.
- Press the C [-] button twice (double-click) during playback to start playback from the previous Song.
- Press the C [+] button during playback to start playback from the next Song.
- Press the [STOP] button or simultaneously press the B [- (NO)][+ (YES)] buttons during playback or while playback is stopped in the middle of the Song to locate the top of the Song.

## Resetting the Tempo

Whenever you select a new Preset Song, the tempo is automatically reset to the Song's original value.

**NOTE** Performance mode is automatically turned off if you start Song playback while Performance mode is on.

## Automatically Starting Song Playback by Playing the Keyboard— Synchro Start

You can pause playback to begin when you play the keyboard (Synchro Start). Hold down the [STOP] button and press the [PLAY/PAUSE] button. The [PLAY/PAUSE] indicator will blink, and the CP300 will wait for Synchro Start.

In this condition, playback begins as soon as you play the keyboard.

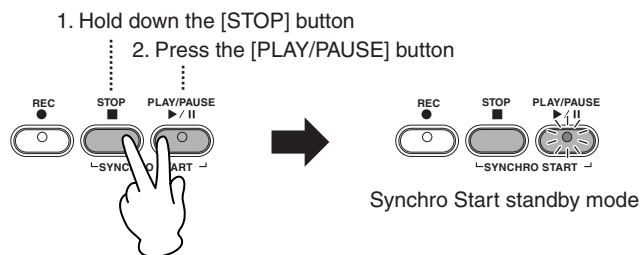

**NOTE** If you press the [STOP] button while waiting, Synchro Start will be cancelled.

## Pedal Play/Pause

You can alternately start or pause Song playback by pressing a pedal connected to the CP300's [ASSIGNABLE FOOT PEDAL] jack. A pedal connected to the [ASSIGNABLE FOOT PEDAL] jack can be assigned to play and pause Preset Song playback from the "Pedal Play/Pause" parameter in the Other Settings function described on page 70.

This is convenient when performing along with previously recorded parts—it lets you stop and start playback of the recorded backing, while you add parts of your own live.

## Turning Part Playback On and Off

While the CP300 is playing or stopped, pressing these track buttons turn off the indicators, and the data on those parts will not be played. Pressing the part buttons toggles part playback on and off. Turning a playback part off lets you play that part yourself while the other parts play back.

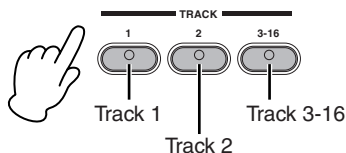

# Convenient Functions

This section covers various functions that you'll find come in handy as you play and perform with the instrument.

## Panel Lock Function

The panel lock function can temporarily disable the panel operation and prevent unintended operation during live performance.

### 1 Double-click the [PANEL LOCK] button (press it quickly twice).

The [PANEL LOCK] button lights. A "PANEL LOCK" message also appears in the display. While the Panel Lock function is engaged, panel operations will be ignored.

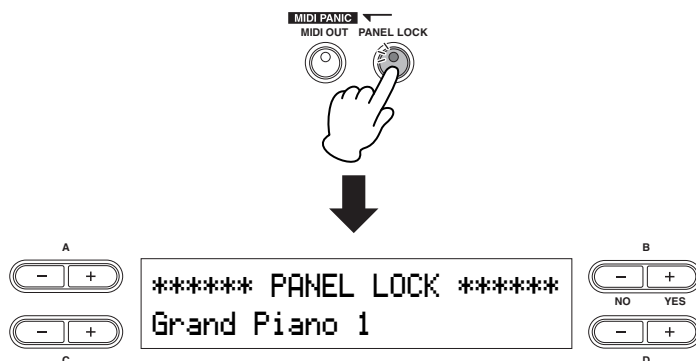

### 2 To cancel Panel Lock, double-click the [PANEL LOCK] button.

The [PANEL LOCK] button turns off, and the display returns to the previous display.

**NOTE** The Panel Lock function affects all controls, with the exception of the [MASTER VOLUME] dial, the [SONG VOLUME] slider, the [ZONE CONTROL] sliders, the [MASTER EQUALIZER] sliders, the Modulation wheel, the Pitch bend wheel, and the pedals.

## MIDI Transmission On/Off

This parameter specifies whether the CP300 transmits MIDI data to an external MIDI device (On) or not (Off).

Pressing the [MIDI OUT] button alternates between On and Off. MIDI messages can be transmitted if the button lamp is lit. MIDI messages cannot be transmitted if the lamp is off.



**NOTE** This button is equipped with certain MIDI safeguards and also turns off pedal messages during performance. Even if you turn MIDI transmission off while holding a key, a key-off message will still be transmitted when you release the key. Turning MIDI transmission off also sends the following MIDI messages: Sustain Off, Sostenuto Off, Soft Pedal Off.

**NOTE** Keep in mind that if you turn MIDI transmission off, MIDI signals will not be transmitted no matter what other MIDI transmission settings (in Master Edit and MIDI Settings) are made.

## MIDI Panic Control

This function serves as a convenient MIDI “panic” switch during performance when using a connected external tone generator. If the connected tone generator continues to sound (stuck notes, etc.) even after you’ve released the keys of the CP-300, using this MIDI Panic control transmits the necessary messages to stop the tone generator from sounding continuously.

Press the **[REVERB]** button while holding the **[MIDI OUT]** button.

A “MIDI PANIC SEND” message appears in the display.

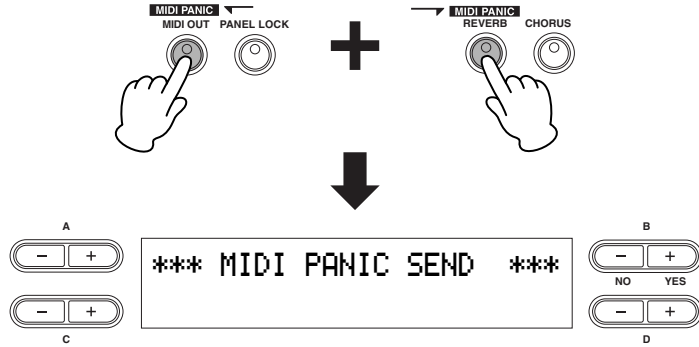

**NOTE** Keep in mind that MIDI Panic transmission will not function if MIDI transmission is set to Off (page 51).  
 MIDI Panic messages: All Note Off, All Sound Off, Reset All Controllers, Sustain Off, Sostenuto Off, Modulation Depth Off, Pitch Bend Center, Channel Pressure Off

## Built-in Speakers On/Off

This parameter specifies whether the CP300’s built-in speakers produce sound (On) or not (Off). Pressing the **[SPEAKER]** button alternates between On and Off. The built-in speakers produce sound if the lamp is lit, and do not sound if the lamp is off.



**NOTE** If the **[SPEAKER]** button is lit, the built-in speakers sound normally even when using the headphones.

# Reference Section

## Master Settings—Master Edit

The Master mode allows you to divide the keyboard into up to four independent areas (zones) which will be effective when the [MASTER] button is turned on.

**NOTE** This setting is retained even after you turn off the power to the CP300. If you set the Memory Backup's Master Setting to Off in the Other Settings menu, the Master Settings will return to the default (initial) values when you turn on the power next time (page 71).

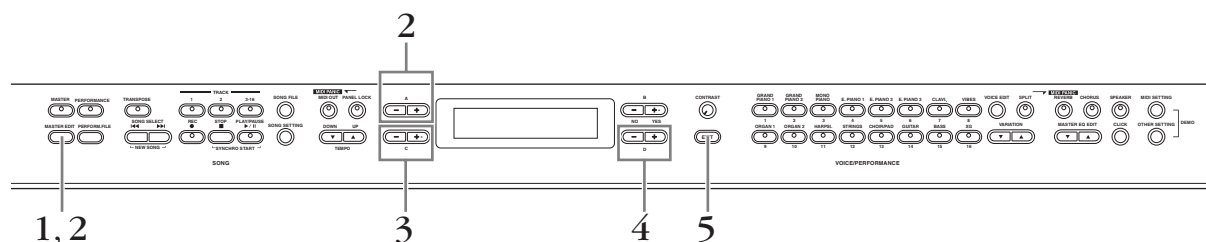

- 1 Press the [MASTER EDIT] button to call up the Master Setting display.

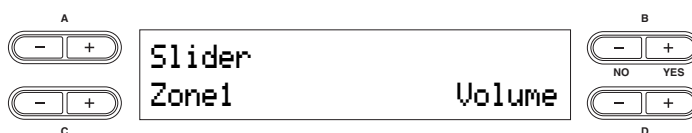

- 2 Select the desired item by pressing the [MASTER EDIT] button or by using the A [-] [+/-] buttons.  
For information about the parameters and their values, refer to “Parameters” on page 54.
- 3 Use the C [-] [+/-] buttons to select a target item.
- 4 Use the D [-] [+/-] buttons to change the value.
- 5 Press the [EXIT] button to exit the Master Setting display and return to normal play.

## Parameters

### Slider Settings

For assigning specific functions to each [ZONE CONTROL] slider.

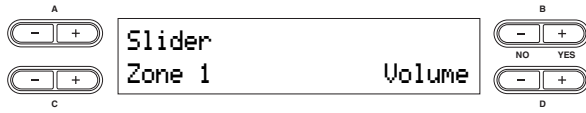

**Setting targets:** Zone 1, Zone 2, Zone 3, Zone 4

**Functions/range:** Volume, Modulation, Brightness, Harmonic Content, After Touch, Control numbers 001 – 031, 033 – 095, Off

**Default setting:** Volume

**NOTE** If you select After Touch or control numbers 001 – 031, 033 – 095, the slider affects only connected MIDI instruments and not the CP300 itself.

### Bank Select MSB Settings for MIDI Transmission to an External Tone Generator

You can select specific Voices or programs on a connected MIDI device by specifying a Bank Select MSB value, in combination with the Bank Select LSB and Program Change parameters below.

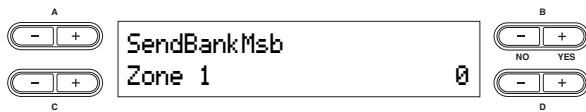

**Setting targets:** Zone 1, Zone 2, Zone 3, Zone 4

**Setting range:** 0 – 127

**Default setting:** 0

The three specified MIDI messages—Bank Select MSB, Bank Select LSB and Program Change—will be transmitted in the following conditions:

- When turning on the Master mode.
- When changing any of the values of Bank Select MSB, Bank Select LSB or Program Change when the Master mode is on.
- When selecting a Performance which was saved with the Master mode on.

### Bank Select LSB Settings for MIDI Transmission to an External Tone Generator

You can select specific Voices or programs on a connected MIDI device by specifying a Bank Select LSB value, in combination with the Bank Select MSB parameter (above) and the Program Change parameter (below).

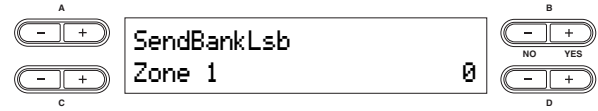

**Setting targets:** Zone 1, Zone 2, Zone 3, Zone 4

**Setting range:** 0 – 127

**Default setting:** 0

The three specified MIDI messages—Bank Select MSB, Bank Select LSB and Program Change—will be transmitted in the following conditions:

- When turning on the Master mode.
- When changing any of the values of Bank Select MSB, Bank Select LSB or Program Change when the Master mode is on.
- When selecting a Performance which was saved with the Master mode on.

### Program Change Number Settings for MIDI Transmission to an External Tone Generator

You can select specific Voices or programs on a connected MIDI device by specifying a Program Change number, in combination with the Bank Select MSB and Bank Select LSB parameters above.

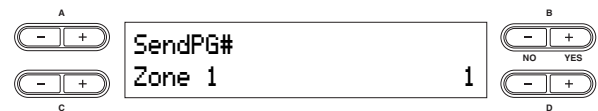

**Setting targets:** Zone 1, Zone 2, Zone 3, Zone 4

**Setting range:** 1 – 128

**Default setting:** 1

The three specified MIDI messages—Bank Select MSB, Bank Select LSB and Program Change—will be transmitted in the following conditions:

- When turning on the Master mode.
- When changing any of the values of Bank Select MSB, Bank Select LSB or Program Change when the Master mode is on.
- When selecting a Performance which was saved with the Master mode on.



### Octave Setting for Connected External Tone Generator

The pitch of a note can be shifted upward or downward in steps of an octave in each zone. You can adjust the offset up or down over a maximum range of two octaves.

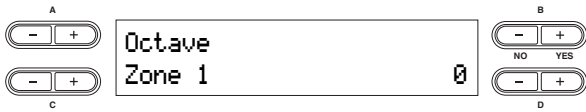

**Setting targets:** Zone 1, Zone 2, Zone 3, Zone 4

**Setting range:** -2 – 0 – +2

-2 (two octaves lower), 0 (no pitch shift), +2 (two octaves higher)

**Default setting:** 0

The Octave setting is effective when the [MASTER] button is on. It also affects the following settings:

Internal: [VOICE EDIT] Octave setting for each Voice

MIDI Output: [MASTER EDIT] Octave setting for each zone

When the [MASTER] button is off, Octave affects the following:

Internal and MIDI Output: [VOICE EDIT] Octave setting for each Voice

### Internal Tone Generator On/Off Status

Turns the sound from the internal tone generator on or off for each part.

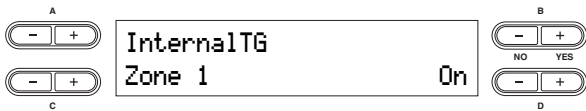

**Setting targets:** Zone 1, Zone 2, Zone 3, Zone 4

**Settings:** On/Off

**Default setting:** On

### MIDI Transmission Channel for Master Mode

Specifies the channels over which the CP300 transmits MIDI data from each zone.

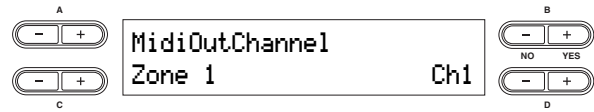

**Setting targets:** Zone 1, Zone 2, Zone 3, Zone 4

**Setting range:** Ch 1 – Ch 16, Off

**Default settings:**

Zone 1	Ch 1
Zone 2	Ch 2
Zone 3	Ch 3
Zone 4	Ch 4

**NOTE** When the [MASTER] button is turned off, the “MIDI Out Channel” setting in the MIDI Settings menu is used for MIDI channel assignments.

# Detailed Settings for the Voices—Voice Edit

You can make detailed settings for Voice. You can make these settings for each Voice (or each combination of Voices) individually.

## Voice Edit—Basic Operation

- 1 **Select the desired Voice or combination of Voices.**  
For instructions on how to select a Voice, see page 25.
- 2 **Press the [VOICE EDIT] button to access the Voice Edit menu.**
- 3 **Use the A [-][+] buttons to select the part for which you wish to change the Voice.**  
The range of the displayed part varies depending on the selected Voice.

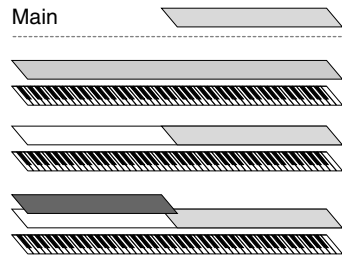
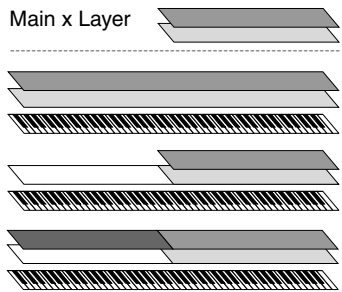
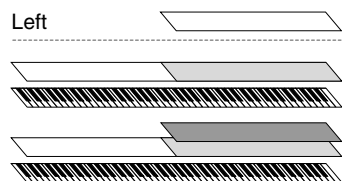
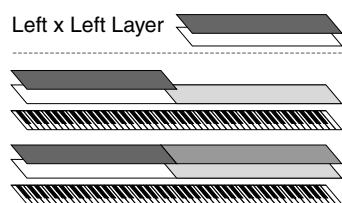
Voice Part	Display	Setup
	<pre>Main      Set?--&gt; Octave    0</pre> <p>MAIN Voices (displayed with a single Voice or in Split mode)</p>	The Main part Voice can be set.
	<pre>MainxLayer Set?--&gt; Octave(GrndPno1) 0</pre> <p>Displayed when the MAIN side is in Dual mode</p>	The Main part Voice and Layer part Voice can be set.
	<pre>Left      Set?--&gt; Octave    0</pre> <p>Displayed in Split mode</p>	The Left part Voice can be set.
	<pre>LeftxLeftLayer Set?--&gt; Octave(GrndPno1) 0</pre> <p>Displayed when the LEFT side is in Dual mode</p>	The Left part Voice and Left Layer Voice can be set.

**NOTE** For details about the split point settings between the Main part and Left part, refer to the “To Change the Split Point Setting” (page 32) or the “Split Point” parameter in the Other Settings menu (page 69). The split point settings for the Layer part and Left Layer part can be changed via the “Split Point 2” parameter in the Other Settings menu (page 69).

For information about the parameters and their values, refer to “Parameters” on page 58.

#### 4 Use the C [-][+] buttons to select a target item.

You can change the Voice for each part when Main x Layer or Left x Left Layer is selected in Step 3 (in Dual mode). The target Voice name will be displayed in parentheses.

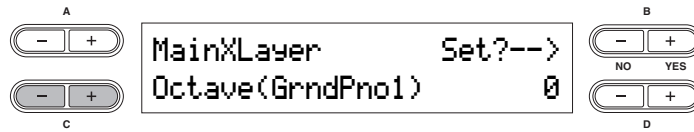

#### 5 Use the D [-][+] buttons to change the value.

Press the [-][+] buttons simultaneously to instantly reset to the default setting.



#### 6 Press the B [+ (YES)] button to execute the job.

To proceed, press the B [+ (YES)] button again. An “Executing” message appears and the data is saved. When the operation is complete, a “Completed” message appears briefly, then returns to the previous display.



**NOTE** This setting will be retained even if you turn off the power to the CP300. The previous settings will be restored when you turn on the power next time and the same Voice or part you selected before turning the power off will automatically be selected.

#### 7 Press the [EXIT] button to exit from the Voice Edit settings.

## Parameters

When the Voice part is set to Main x Layer or Left x Left Layer, parameters indicated with an asterisk (\*) below are set for each part's Voice individually.

### Octave\*

This allows you to shift the pitch of a note upward or downward in octave steps, over a range of +/- two octaves.

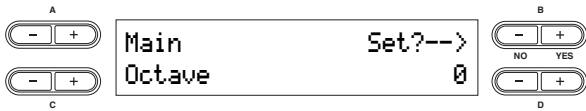

**Setting range:** -2 – 0 – +2  
-2 (two octaves lower), 0 (no pitch shift), +2 (two octaves higher)

### Volume\*

This allows you to set the volume level for each Voice part.

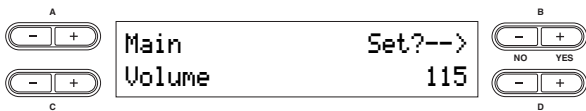

**Setting range:** 0 – 127

### Pan (Stereo position)\*

This allows you to set the position of the sound in the stereo field, left or right.

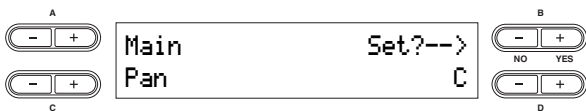

**Setting range:** L64 (hard left) – C (center) – R63 (hard right)

### Detune (Dual mode only)

This allows you to finely tune the pitches of the two Voices selected in Dual mode away from each other. Used especially with similar sounding Voices, this creates a warmer, richer sound.

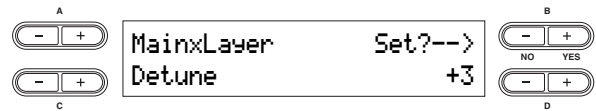

**Setting range:** -20 – +20 (Positive (+) settings will raise the pitch of the Main or Left Voice part's sound and lower the pitch of the Layer or Left Layer Voice part's sound. Negative (-) settings will do the opposite.)

### Reverb Type

This determines the types of Reverb effects used for the Voices of the Main and Main x Layer parts. The Reverb Type settings here are also used for the Voices of the Left and Left x Left Layer parts, respectively. (These cannot be set independently from the Main and Main x Layer Voices.)

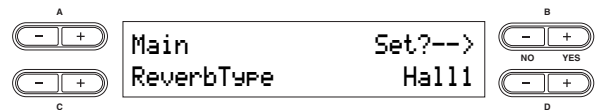

#### Settings:

Room	Simulates the reverberation of a room.
Hall1	Simulates the reverberation of a concert hall.
Hall2	Reverberation is slightly longer than that of Hall 1.
Stage	Reverberation suitable for a solo instrument sound.
Plate	Simulates the characteristic sound of a plate reverb.

### Reverb Send\*

This allows you to control the depth of the reverb effect for the Voice.

**NOTE** The reverb effect is not applied if “Reverb Send” is set to “0.”

**NOTE** Reverb Send can be set independently for all Voice parts—Main, Main x Layer, Left, and Left x Left Layer.

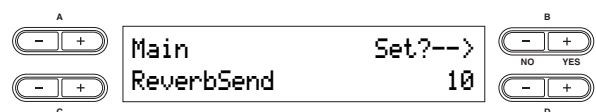

**Setting range:** 0 – 127

### Chorus Type

This determines the types of Chorus effects used for the Voices of the Main and Main x Layer parts. The Chorus Type settings here are also used for the Voices of the Left and Left x Left Layer parts, respectively. (These cannot be set independently from the Main and Main x Layer Voices.)

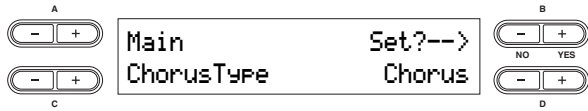

**Settings:**

Chorus	Makes the sound more rich and spacious.
Celeste	Adds warm animation and spaciousness to the sound.
Flanger	Adds a sweeping, metallic sound, similar to a jet airplane.

### Chorus Send\*

This allows you to control the depth of the chorus effect for the Voice.

**NOTE** Chorus Send can be set independently for all Voice parts—Main, Main x Layer, Left, and Left x Left Layer.

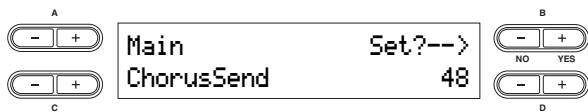

**Setting range:** 0 – 127

### Chorus On/Off

This allows you to set the [CHORUS] button on or off for each Voice. When you select a Voice, the [CHORUS] button on/off setting for the Voice automatically changes according to this parameter's setting.

**NOTE** Even if this parameter is turned on, the chorus effect is disabled if “Chorus Send” is set to 0.

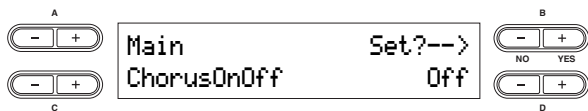

**Setting range:** On/Off

### Insertion Effect Type\*

This allows you to select from a variety of effects (other than reverb and chorus).

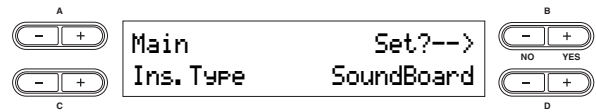

**Settings:**

DelayLCR	Delay applied at left, center, and right positions.
DelayLR	Delay applied at left and right positions.
Echo	Echo-like delay
CrossDelay	Left and right delays are crossed.
Symphonic	Adds a rich and deep acoustic effect.
Rotary	Adds the vibrato effect of a rotary speaker.
Tremolo	Changes the volume level in rapid cycles.
VibeRotor	Produces the vibrato effect of a vibraphone.
AutoPan	Automatically pans the sound left to right and back and forth.
Phaser	Changes the phase of the sound periodically, creating sweeping effects.
AutoWah	Changes the center frequency of the wah filter periodically.
SoundBoard	Simulates the reverberation of a piano soundboard.
AmpSimulator	Recreates the distortion effect of a guitar amp.
Compressor	This squeezes the dynamic range of a sound, giving the overall sound greater “punch” and impact.
Off	No effect

### Vibe Rotor Speed\*

This applies only to the Vibraphone Voice and allows you to change the speed of the vibrato effect (controlled by the Modulation wheel), simulating the electric rotor on an actual vibraphone.

This is displayed only if “Vibe Rotor” is selected for the “Ins. Type” parameter.

It enables you to set the speed of vibrato when you select the Vibraphone Voice and use the Modulation wheel.

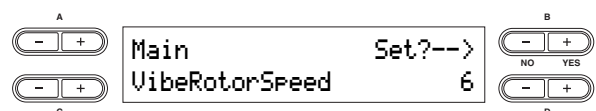

**Setting range:** 1 – 10

### Vibe Rotor On/Off\*

This applies only to the Vibraphone Voice and allows you to turn the vibrato effect (controlled by the Modulation wheel) on and off. This is displayed only if “Vibe Rotor” is selected for the “Ins. Type” parameter. When the Vibraphone Voice is selected, the Vibe Rotor effect is automatically set to On.

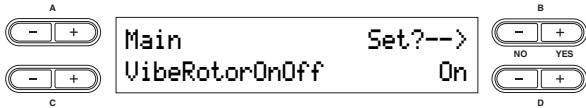

Setting range: On/Off

### Rotary Speed\*

This allows you to set the rotation speed of the rotary speaker effect. This is displayed only if “Rotary” is selected for the “Ins. Type” parameter.



Setting range: Slow/Fast

### Dry/Wet Balance\*

This allows you to set the depth of the Insertion effect. Some “Ins. Type” settings do not allow you to set the “Dry/Wet Balance.”

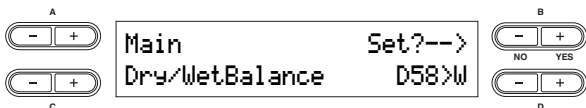

Setting range: D63>W – D=W – D<W63

D63>W (outputs only the original sound with almost no effect applied)

D=W (dry/wet balance is even)

D<W63 (outputs only the sound processed by the effect)

### Brightness\*

This allows you to set the brightness of the sound.

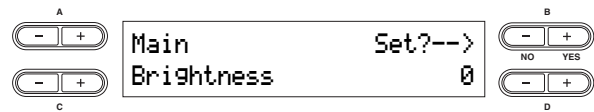

Setting range: -64 – +63

### Harmonic Content\*

This allows you to adjust the resonance of the sound.

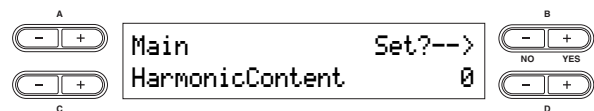

Setting range: -64 – +63

### EQ Low Frequency\*

This allows you to adjust the low-range frequency of the part EQ.

**NOTE** For details about EQ or Equalizer, refer to page 36.

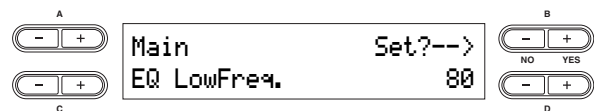

Setting range: 32 Hz – 2.0 kHz

### EQ Low Gain\*

This allows you to adjust the low-range gain (amount of boost/cut of the low frequencies) of the part EQ.

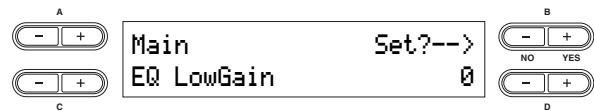

Setting range: -12 dB – +12 dB

### EQ High Frequency\*

This allows you to adjust the high-range frequency of the part EQ.



Setting range: 500 Hz – 16 kHz

### EQ High Gain\*

This allows you to adjust the high-range gain (amount of boost/cut of the high frequencies) of the part EQ.

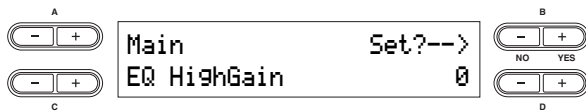

Setting range: -12 dB – +12 dB

### Touch Sensitivity (Touch Sense)\*

This allows you to determine the manner and degree to which the volume level changes in response to your touch on the keyboard (how hard you play). Since the volume level of actual harpsichords and pipe organs does not change regardless of how you play the keyboard, the normal setting for these Voices is 127. (See the setting range below.)

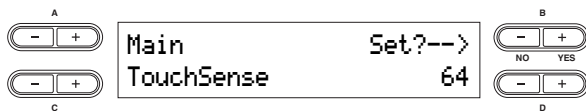

Setting range: 0 – 64 – 127

- 0: Softest level
- 64: Normal touch response; optimum dynamic range
- 127: Loudest level; fixed (no change in response to touch)

### Assigning the Pedal 1 Function

This allows you to assign a specific function to the pedal connected to the [1 SUSTAIN] jack.

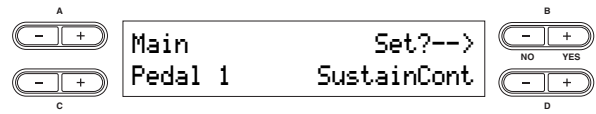

Settings:

Sustain	On/Off switch-type damper (page 33).
SustainCont	Damper function that sustains the sound longer the further down you press the pedal (page 33)
Sostenuto	Sostenuto pedal (page 33)
Soft	Soft pedal (page 33)
Expression*	Makes the sound softer or louder
Off	No function is assigned

\*For best results, use an optional Yamaha FC7 Foot Controller.

### Assigning the Pedal 2 Function

This allows you to assign a specific function to the pedal connected to the [2 SOSTENUTO] jack.

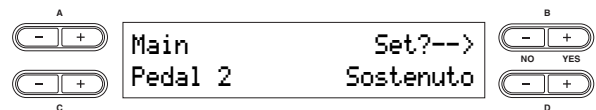

Setting range: same as "Pedal 1" (above)

### Assigning the Pedal 3 Function

This allows you to assign a specific function to the pedal connected to the [3 SOFT] jack.

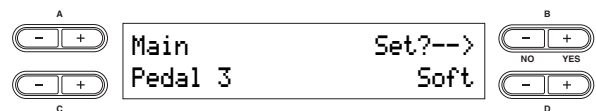

Setting range: same as "Pedal 1" (above)

### Assigning the Pedal 4 Function

This allows you to assign a specific function to the pedal connected to the [4 AUX] jack.

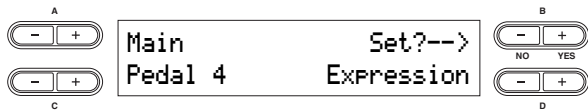

**Settings:**

Sustain	On/Off switch-type damper (page 33)
SustainCont	Damper function that sustains the sound longer the further down you press the pedal (page 33).
Sostenuto	Sostenuto (page 33)
Soft	Soft (page 33)
Expression	Makes the sound softer or louder.
ReverbSend	Adds reverb accents to notes being played.
ChorusSend	Adds chorus accents to notes being played.
Brightness	Adds brightness accents to notes being played.
Harmonic Content	Adds resonance accents to notes being played.
AfterTouch	Adds after-touch accents to notes being played (MIDI transmit only)
Ctrl #0 – #119	Adds accents by controllers #0 – 119 to notes being played (MIDI transmit only).
Off	No function is assigned.

### Assigning the Modulation Wheel Function

This allows you to specify the parameter controlled by the modulation wheel.

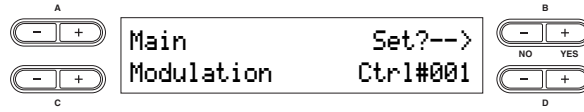

**Settings:**

Expression	Makes the sound softer or louder.
MainVolume	Changes the volume level of notes being played in the Main part. (Displayed only when Main is in Dual mode.)
LayerVolume	Changes the volume level of notes being played in the Layer part. (Displayed only when Main is in Dual mode.)
LeftVolume	Changes the volume level of notes being played in the Left part. (Displayed only when Left is in Dual mode.)
LeftLayer Volume	Changes the volume level of notes being played in the Left Layer part. (Displayed only when Left is in Dual mode.)
RotarySpeed	Changes the rotary speaker effect's rotation speed.
VibeRotor	Changes the vibraphone's vibrato speed.
Modulation	Adds modulation accents.
ReverbSend	Adds reverb accents to notes being played.
ChorusSend	Adds chorus accents to notes being played.
Brightness	Adds brightness accents to notes being played.
Harmonic	Adds resonance accents to notes being played.
AfterTouch	Adds after-touch accents to notes being played (MIDI transmit only).
Ctrl #0 – #119	Adds accents by controllers #0 – 119 to notes being played (MIDI transmit only).
Off	No function is assigned.



# Detailed Settings for MIDI Operations—MIDI Settings

Here you can make settings for MIDI applications, such as MIDI receive/transmit channels and other settings necessary when using the CP300 with other MIDI devices.

**NOTE** These settings will be retained even if you turn off the power to the CP300. If you set the Memory Backup's MIDI Setting to Off in the Other Settings menu, the MIDI Settings will return to the default (initial) values when you turn on the power next time (page 71).

**NOTE** While the Master mode is turned on, the “MIDI Out Channel” parameter and “MIDI Out Select” parameter in the MIDI Settings menu are not effective.

## About MIDI

MIDI (Musical Instrument Digital Interface) is a standard format for data transmission/reception. It enables the transfer of performance data and commands between MIDI devices and personal computers. Using MIDI, you can control a connected MIDI device from the CP300, or control the CP300 from a connected MIDI device or computer.

## MIDI Channels

MIDI data is transferred over 16 channels numbered from 1 through 16. Using these channels, 1 – 16, the performance data for sixteen different instrument parts can be simultaneously sent over one MIDI cable. Think of the MIDI channels as TV channels. Each TV station transmits its broadcasts over a specific channel. Your home TV set receives many different programs simultaneously from several TV stations and you select the appropriate channel to watch the desired program.

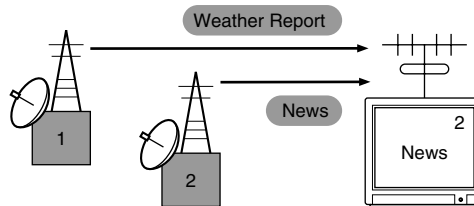

MIDI operates on the same basic principle. The transmitting instrument sends MIDI data on a specific MIDI channel (MIDI Transmit Channel) via a single MIDI cable to the receiving instrument. If the receiving instrument's MIDI channel (MIDI Receive Channel) matches the Transmit Channel, the receiving instrument will sound according to the data sent by the transmitting instrument.

For detailed information on how to set the MIDI transmit channel and the MIDI receive channel, refer to page 65.

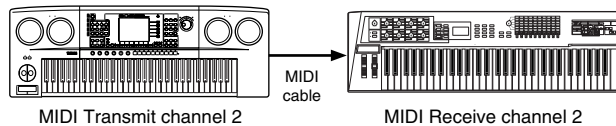

# MIDI Settings—Basic Operation

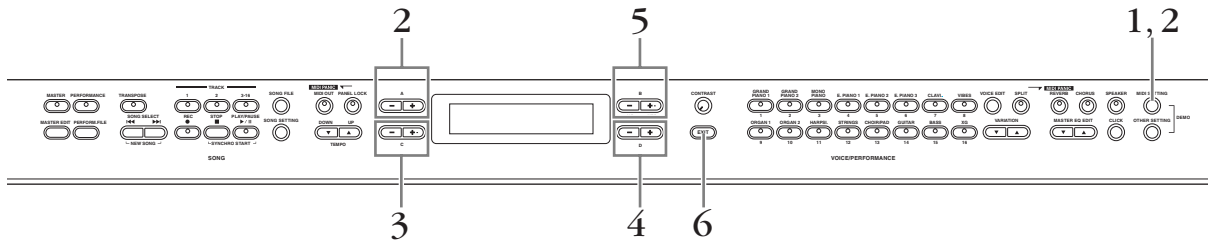

- 1 Press the [MIDI SETTING] button to call up the MIDI Settings menu.
- 2 Select the desired item by pressing the [MIDI SETTING] button or by using the A [-] [+] buttons.  
For information about the parameters and their values, refer to “Parameters” on page 65.
- 3 Use the C [-][+] buttons to select a target item.
- 4 Use the D [-][+] buttons to change the value.  
Press the [-][+] buttons simultaneously to instantly reset to the default setting.

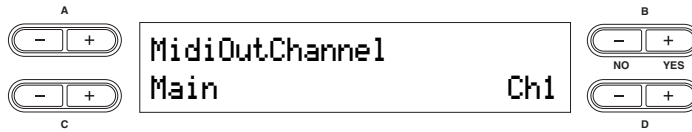

- 5 Press the B [+ (YES)] button to execute the job, if a “Start?” message appears.  
Press the B [+ (YES)] button to call up the confirmation prompt (“Sure?”). Press the B [+ (YES)] button once again to actually execute the job. An “Executing” message appears and the data is saved. When the operation is complete, a “Completed” message appears briefly, then returns to the previous display.  
To cancel the operation, press the B [- (NO)] button instead of the B [+ (YES)] button.

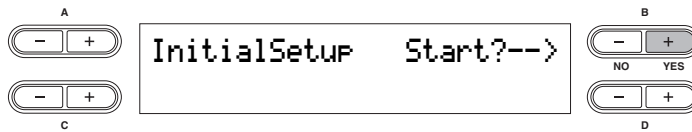

- 6 Press the [EXIT] button to exit the MIDI Settings menu.

## Parameters

### MIDI Transmit Channel Selection

This allows you to specify the channel over which the CP300 transmits MIDI data.

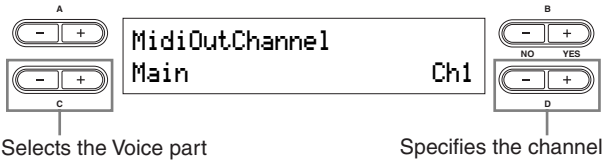

**Setting targets:** Main, Left, Layer, Left Layer

**Setting range:** Ch 1 – Ch 16, Off (not transmitted)

**Default settings:**

Main	Ch 1
Left	Ch 2
Layer	Ch 3
Left Layer	Ch 4

**NOTE** While the Master mode is turned on, “MIDI Out Channel” parameter in the Master Edit menu will be enabled for MIDI channel assignments.

### MIDI Receive Channel Selection

This allows you to specify the channel over which the CP300 receives data from the MIDI [IN] or USB connectors.

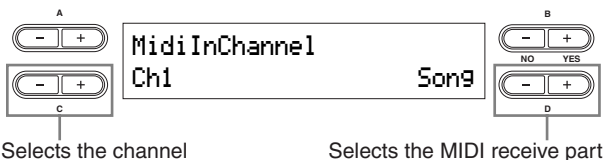

**Setting targets:** Song, Main, Left, Layer, Left Layer, Keyboard, Off

**Setting range:** Ch 1 – Ch 32

**Default settings:**

Ch 1 – Ch 16	Song
Ch 17	Keyboard
Ch 18	Main
Ch 19	Left
Ch 20	Layer
Ch 21	Left Layer
Ch 22 – Ch 32	Off

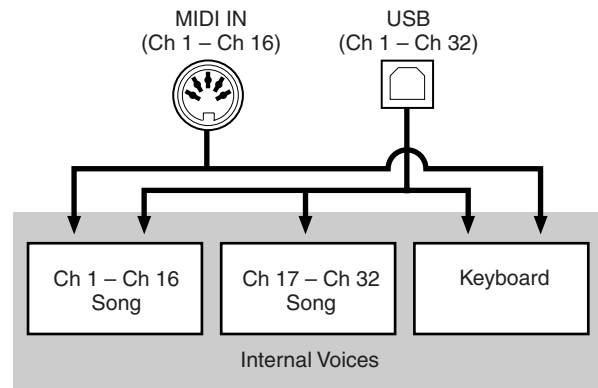

### Local Control On/Off

“Local Control On” is a state in which the CP300 produces the sound from its tone generator when you play the keyboard. In “Local Control Off” state, the keyboard and the tone generator are cut off from each other. This means that even if you play the keyboard, the CP300 will not produce the sound. Instead, the keyboard data can be transmitted via MIDI to a connected MIDI device, which can produce the sound. The “Local Control Off” setting is useful when you wish to play an external sound source while playing the keys on the CP300, but don’t want the CP300 to sound. It’s also useful for recording data to a sequencer/computer and using the sequencer to route the data to the appropriate tone generator or instrument.

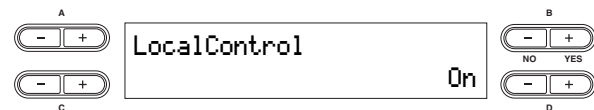

**Setting range:** On/Off

**Default setting:** On

### MIDI Out Select

This allows you to select whether your performance data or Song playback data is sent via MIDI.

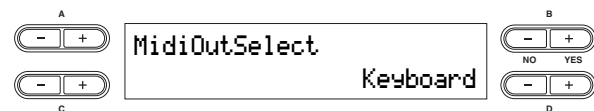

**Settings:**

Keyboard	Performance data played on the keyboard
Song	Song playback data

**Default setting:** Keyboard

**NOTE** While the Master mode is turned on, keyboard performance data is transmitted no matter what setting is made here.

### MIDI Receive Parameter

This allows you to specify which types of MIDI data the CP300 will receive and respond to.

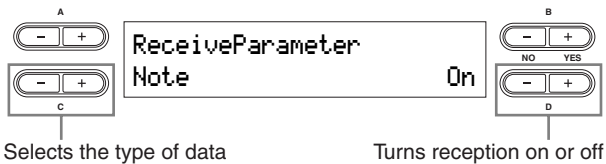

Selects the type of data

Turns reception on or off

**Type of data:** Note, Control, Program, AfterTouch, PitchBend, SysEx (System Exclusive)

**Setting range:** On/Off

**Default setting:** On for all types of data

### MIDI Transmit Parameter

This allows you to specify which types of MIDI data the CP300 will transmit.

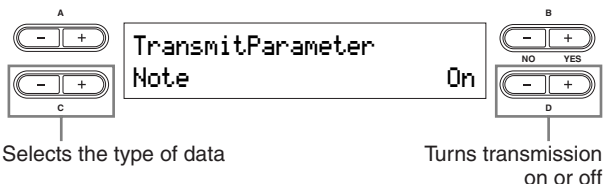

Selects the type of data

Turns transmission on or off

**Type of data:** Note, Control, Program, AfterTouch, PitchBend, SystemRealTime, SysEx (System Exclusive)

**Setting range:** On/Off

**Default setting:** On for all types of data

### Transmitting the Default Settings on the Panel

This allows you to transmit initial panel setup data, such as Voice selection and other settings, to a connected sequencer. This is useful when you record performance data to a sequencer, since it lets you take a “snapshot” of the CP300 settings you want to use at the beginning of a recorded Song and have those settings automatically called up for you when you play back the Song.



### Bulk Dump

You can transmit each setting data as the MIDI setting bulk data.

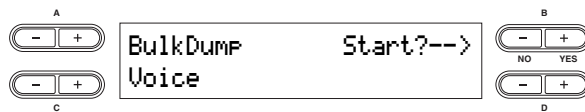

**Type of data:**

Current	The data is set on the panel
Performance	The data saved to the Performance
Voice	The Voice data saved using Voice Edit
MemorySong/ Perf.File	The Performance file, the data saved to the Song file.
ALL	Send each bulk in sequence.

**Default setting:** Current

Bulk data cannot be transmitted in the following situations:

- Song record/playback
- Song recording standby
- When selecting recording tracks
- Demo Song playback

Bulk data cannot be received in the following situations:

- Song record/playback
- Song recording standby
- When selecting recording tracks
- Demo Song playback
- When transmitting bulk data
- When the message “Receiving bulk data has failed” appears

If the Performance file has 56 files, or the Song file has 112 Songs (1.4 MB), the data transfer will take at least 3 minutes if you are using the USB connection, or 21 minutes if you are using the MIDI connection.

**NOTE** If you’ve changed the “Character Code” setting (page 84) since naming a Song and the Song name does not display correctly, bulk data cannot be transmitted.

**NOTE** Press the B [– (NO)] button or [EXIT] button to cancel the transmission.

### CAUTION

Never attempt to turn off the power while bulk data is being transmitted. Turning the power off in this state results in loss of all user data.

# Miscellaneous CP300 Settings—Other Settings

The Other Setting(s) menu provides a variety of settings, generally related to the overall sound and operation of the CP300. These include detailed settings for touch response, tuning, pedal operation, and more.

**NOTE** The edited Other Settings will be erased after you turn off the power to the CP300. If you set the Memory Backup's Other Setting to On in the Other Settings menu, the current Other Settings' values will remain in effect when you turn the power off and back on again (page 71).

## Other Settings—Basic Operation

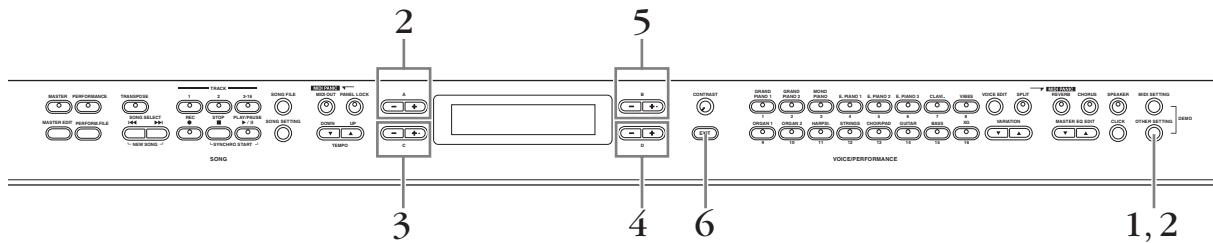

- 1 Press the [OTHER SETTING] button to call up the Other Settings menu.
- 2 Select the desired item by pressing the [OTHER SETTING] button or by using the A [-][+] buttons.  
For information about the parameters and their values, refer to “Parameters” on page 68.
- 3 Use the C [-][+] buttons to select a target item.
- 4 Use the D [-][+] buttons to change the value.  
Press the [-][+] buttons simultaneously to instantly reset to the default setting.

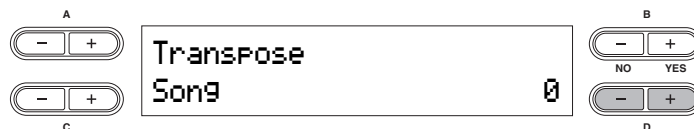

- 5 Press the B [+ (YES)] button to execute the job (if an “Execute?” message appears).  
Pressing the B [+ (YES)] button calls up a confirmation prompt (“Sure?”). Press the B [+ (YES)] button again to execute the job. An “Executing” message appears and the data is saved. When the operation is complete, a “Completed” message appears briefly, then returns to the previous display.  
To cancel the operation, press the B [- (NO)] button instead of the B [+ (YES)] button.

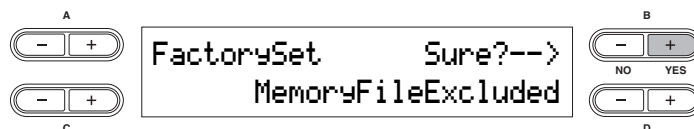

- 6 Press the [EXIT] button to exit from the Other Settings menu.

## Parameters

### Touch Response

This allows you to specify the touch response of the CP300's keyboard, or change how the sound responds to the way you play the keys.

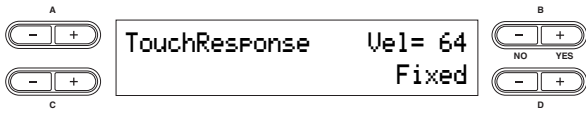

**Settings:**

Light	A soft playing touch results in a relatively loud sound. The volume level tends to be consistent.
Medium	Standard touch response.
Heavy	The keys must be played very strongly to generate loud volume. This setting is best for a wide dynamic range and optimum expressive control of the sound, from pianissimo to fortissimo.
Fixed	No touch response. The volume level will be the same regardless of how strongly you play the keys. Use the B [- (NO)]/[+ (YES)] buttons to set the fixed volume level. Setting range of the fixed volume level: 1 – 127

**Default setting:** Medium

### Tune

This allows you to finely tune the pitch of the entire instrument—a useful feature when playing the CP300 along with other instruments or CD music.

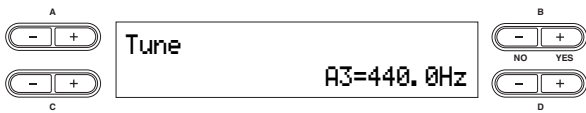

**Setting range:** A3 = 427.0 Hz – 453.0 Hz (0.1 Hz steps)

**Default setting:** A3 = 440.0 Hz

### Piano Tuning Curve

This allows you to specify a tuning curve, Stretch or Flat, for the Piano Voices groups (Grand Piano 1, Grand Piano 2 and Mono Piano). Actual piano tuners often employ stretch tuning, extending the upper octaves of the piano slightly to compensate for the perception of the human ear in the higher range. The Flat setting is an acoustically perfect tuning, to be used if the stretch-tuned piano Voice sounds out of tune with other instrument Voices.

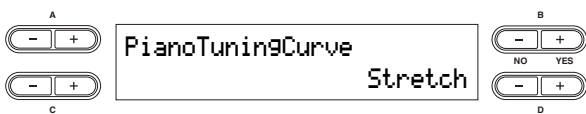

**Settings:**

Stretch	Tuning curve particularly for pianos, with higher octaves slightly "stretched."
Flat	Tuning curve in which the frequency relationships are precisely duplicated in all octaves.

**Default setting:** Stretch

### Scale

This allows you to select different scales or tuning systems for the instrument. Equal Temperament is the most common contemporary piano tuning scale. However, history has known numerous other scales, many of which serve as the basis for certain genres of music. You can experience these tunings with the CP300.

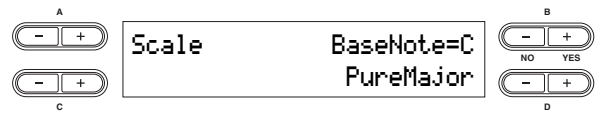

**Settings:**

Equal	The pitch range of each octave is divided equally into twelve parts, with each half-step evenly spaced in pitch. This is the most commonly used tuning in music today.
PureMajor	These tunings preserve the pure mathematical intervals of each scale, especially for triad chords (root, third, fifth). You can hear this best in actual vocal harmonies—such as choirs and a <i>cappella</i> singing.
PureMinor	
Pythagorean	This scale was devised by the famous Greek philosopher and is created from a series of perfect fifths, which are collapsed into a single octave. The 3rd in this tuning are slightly unstable, but the 4th and 5th are beautiful and suitable for some leads.
MeanTone	This scale was created as an improvement on the Pythagorean scale, by making the major third interval more "in tune." It was especially popular from the 16th century to the 18th century. Handel, among others, used this scale.
Werckmeister	The Werckmeister and Kirnberger scales were improvements on the mean-tone and Pythagorean scales. The main feature of these scales is that each key has its own unique character. The scales were used extensively during the time of Bach and Beethoven, and even now are often used when performing period music on the harpsichord.
Kirnberger	

**Setting range:** C, C#, D, Eb, E, F, F#, G, Ab, A, Bb, B  
For scales other than Equal, a root note must be specified using the B [- (NO)]/[+ (YES)] buttons.

**Default setting:** Equal

### Split Point

This allows you to specify the split point (the boundary on the keyboard separating the Main part and Left part).

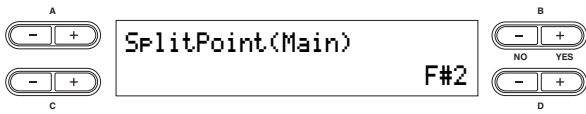

**Setting range:** A-1 – C7  
**Default setting:** F#2

### Split Point 2

This allows you to specify the secondary split point (the boundary on the keyboard separating the Layer part and Left Layer part).

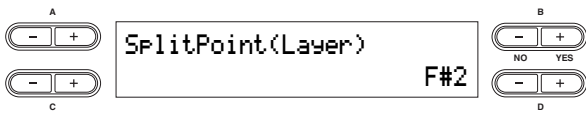

**Setting range:** A-1 – C7  
**Default setting:** F#2

### Transpose

The CP300's Transpose function makes it possible to shift the pitch of the entire keyboard up or down in semitone intervals to facilitate playing in difficult key signatures, and to let you easily match the pitch of the keyboard to the range of a singer or other instruments.

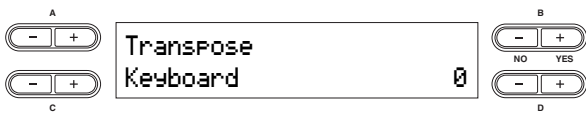

**Setting targets:**

Keyboard	The sound you play with the keys
Song	The sound of Song playback

**Setting range:** -12 – 0 – +12  
 -12 (-1 octave) – 0 (normal pitch) – +12 (+1 octave)  
**Default setting:** Keyboard = 0, Song = 0

- NOTE** The Keyboard settings can only be made when the [TRANSCOPE] button is turned on (page 37).
- NOTE** You can also change the keyboard Transpose setting by using the [TRANSCOPE] button. Whichever method you use, the most recently made settings will be effective.
- NOTE** The Transpose setting affects transmitted MIDI data.

### Soft Pedal Depth

This allows you to specify the depth of the soft pedal effect.

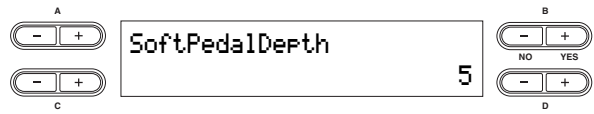

**Setting range:** 1 – 10  
**Default setting:** 5

### String Resonance Depth

This parameter sets the amount or depth of the String Resonance sound and is effective on certain Voice, such as Grand Piano 1.

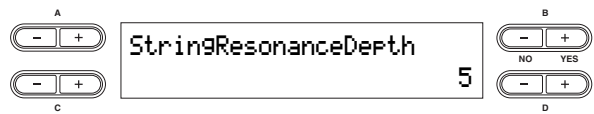

**Setting range:** Off, 1 – 10  
**Default setting:** 5

### Sustain Sampling Depth

This parameter sets the amount or depth of the Sustain Sampling sound and is effective on the Mono Piano 1 and Comp. Piano 1 Voices, as well as on the Grand Piano 1 Voice group.

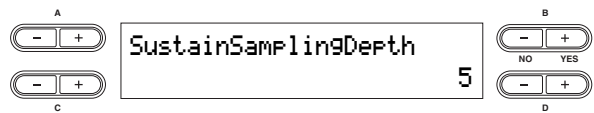

**Setting range:** Off, 1 – 10  
**Default setting:** 5

### Key-off Sampling Depth

This allows you to adjust the volume of the key-off sound (the subtle sound that occurs when you release a key). This parameter is effective on the Grand Piano 1, Mono Piano 1 and Comp. Piano 1 Voices, as well as on the E. Piano 1, Clavi. and Harpsi Voice groups.

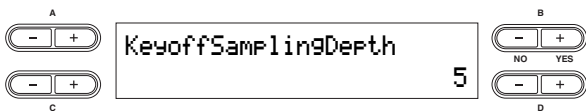

**Setting range:** Off, 1 – 10

**Default setting:** 5

### Vibraphone Pedal Mode

This parameter affects only the Vibraphone Voice, and enables you to select whether the Vibraphone sound is sustained while you press the keys on the keyboard (“Piano Like”) or the sound is sustained only while you press and hold down the sustain pedal, like when playing an actual vibraphone (“Normal”).

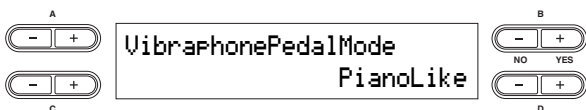

**Setting range:** PianoLike, Normal

**Default setting:** PianoLike

### Pedal Play/Pause

This allows you to assign the Song Play/Pause function to the pedal, letting you start or pause Song playback with your foot. In this setting, the selected pedal (2 – 4) functions in the same manner as the [PLAY/PAUSE] button on the panel.

**NOTE** If you assign the Play/Pause function to a pedal and turn the function On, the pedal function assigned to the pedal in the Voice Edit menu (pages 61 and 62) is disabled.

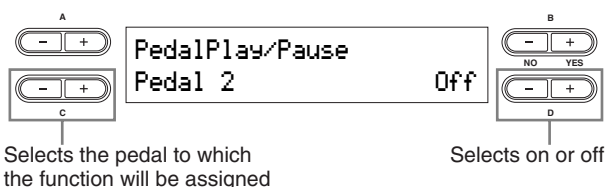

**Setting for:** Pedal 2, Pedal 3, Pedal 4

**Setting range:** On/Off

**Default setting:** Off for all pedals

### Pedal Type

This allows you to select the type or polarity of the pedals you use, connected to the [SUSTAIN] pedal jack, [SOSTENUTO] pedal jack, [SOFT] pedal jack and [AUX] pedal jack. If you are using a Yamaha-recommended pedal (such as the FC4 or FC5), the Pedal Type need not be changed. However, if you are using a pedal of a different manufacturer, the polarity may be opposite and the effect produced by operating the pedal (on/off, dynamics, etc.) might be reversed. If this happens, you can use this setting to correct the pedal operation.

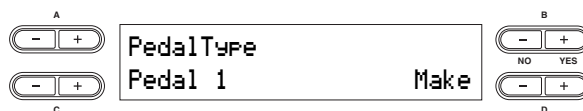

**Setting for:** Pedal 1, Pedal 2, Pedal 3, Pedal 4

**Setting range:** Make, Break

**Default settings:** Pedal 1, Pedal 2, Pedal 3: Make; Pedal 4: Break

### Half Pedal Point

This allows you to set the point at which the damper pedal starts to affect the sound. In other words, you can change the point at which the assigned effect begins to be applied, as you press the pedal down. If the effect is a simple on/off type effect, this setting specifies the point at which the effect will be switched on/off (with the exception of the Expression function).

Refer to the section on assigning the pedal function in the Voice Edit settings (page 61).

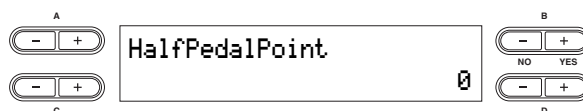

**Setting range:** -2 (effective with the shallowest press) – 0 – +2 (effective with the deepest press)

**Default setting:** 0

### Pitch Bend Range

This allows you to specify the amount of pitch change produced by moving the Pitch bend wheel. This parameter applies only to the manually played sound (not to a connected MIDI device). The value can be set in semitone steps.

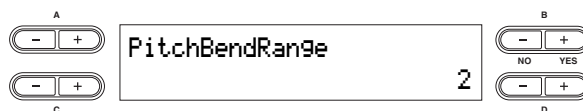

**Setting range:** 0 – 12 semitones (moving the wheel will raise/lower the pitch by a maximum of 12 semitones or 1 octave)

**Default setting:** 2



### Equalizer Lock

This allows you to lock the Master Equalizer settings and prevent them from being changed when selecting a Performance, or by Song playback and incoming MIDI data. However, if bulk data (of the Current type) is received, the Master Equalizer settings will be changed, no matter whether the "Equalizer Lock" is turned on or off. (See Bulk Dump in the MIDI Settings on page 66.)

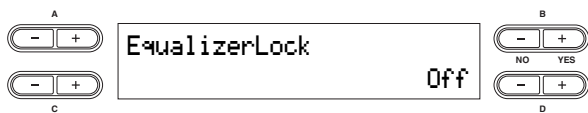

**Setting range:** On/Off  
**Default setting:** On

### Memory Backup

This allows you to select specific items and parameters, such as Voice selection and reverb type, to be automatically saved upon shutdown, ensuring that they will not be lost when you turn off the power to the CP300. If the backup function is turned on for an item, the settings for that item when power is turned off will be in effect the next time power is turned on. If the backup function is turned off for an item, the settings in memory are erased when you turn off the power. In this case, when you turn on the power to the unit, the default settings (the initial settings) will be used. Refer to the "Factory Setting List" on page 101. Keep in mind that the backup settings themselves, the files of the storage memory, and Character Code setting (page 84) are always saved upon shutdown.

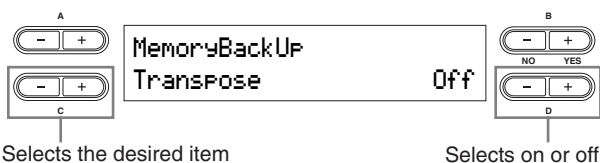

**Setting for:**

Master	Master settings (page 53)
Transpose	Transpose settings (page 69)
Equalizer	Master Equalizer settings (page 72)
ReverbOnOff	Reverb on or off (page 35)
SplitPoint	Split Point settings (page 69)
Main/LeftVoice	Voice, Keyboard part combinations (page 27)
SongSetting	Settings for Song recording and playback (page 85)
MidiSetting	MIDI Settings (page 63)
OtherSetting	Other Settings (page 67)

**Default setting:** The Transpose, Main/LeftVoice and OtherSetting parameters are set to Off. Other parameters are set to On.

### Factory Set

This allows you to reset the CP300 to its default settings.

- The "Character Code" parameter setting does not change (page 84).
- The "Memory Backup" parameter setting (On/Off) is reset to the default setting (left column).
- You can specify whether the files in the storage memory are erased or kept.

#### CAUTION

Never attempt to turn off the power during factory set. Doing so could result in damage to the data.

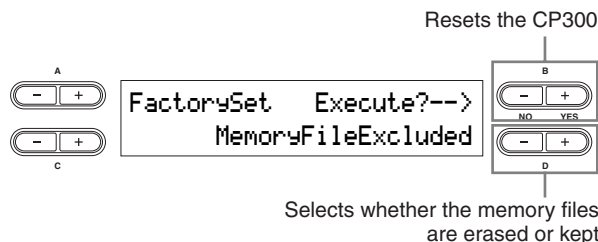

**Selecting for storage memory:**

MemoryFileExcluded	Memory Songs are kept.
MemoryFileIncluded	Memory Songs are erased.

# Master Equalizer Settings

This section explains how to set the Master Equalizer using the Master EQ Edit menu.

**NOTE** This setting is retained even after you turn off the power to the CP300. If you set the Memory Backup's Equalizer setting to Off in the Other Settings menu, the Master Equalizer settings will return to the default (initial) values when you turn on the power the next time (page 71).

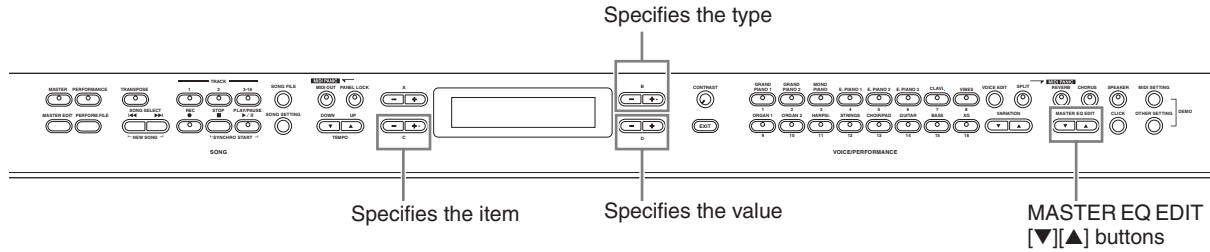

**1** Use the MASTER EQ EDIT [▼][▲] buttons to show the Master EQ Edit display.

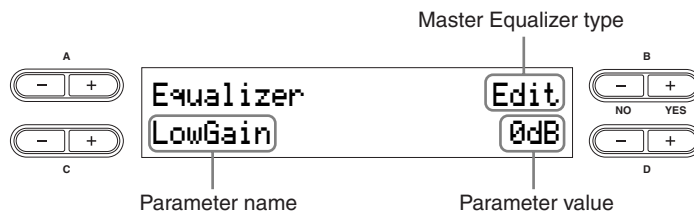

**2** Set the Master Equalizer type by using the MASTER EQ EDIT [▼][▲] buttons or the B [- (NO)][+ (YES)] buttons.

**Setting range:** Mellow 1 – 3, Normal, Bright 1 – 3, Edit

**Default setting:** Edit

**3** Use the C [-][+] buttons to select the parameter item.

**4** Use the D [-][+] buttons to change the value.

The contents of the EQ parameters are briefly explained below.

Parameter name	Contents	Data Range
Low Gain	EQ low-range gain <sup>*1</sup>	-9 dB – +9 dB <sup>*2</sup>
Low Freq.	EQ low-range frequency	32 Hz – 2.0 kHz
Low Q	EQ low-range resonance	0.1 – 12.0
LowMid Gain	EQ low-middle range gain <sup>*1</sup>	-9 dB – +9 dB <sup>*2</sup>
LowMid Freq.	EQ low-middle frequency	100 Hz – 10.0 kHz
LowMid Q	EQ low-middle resonance	0.1 – 12.0
Mid Gain	EQ middle range gain <sup>*1</sup>	-9 dB – +9 dB <sup>*2</sup>
Mid Freq.	EQ middle frequency	100 Hz – 10.0 kHz
Mid Q	EQ middle resonance	0.1 – 12.0
HighMid Gain	EQ high-middle range gain <sup>*1</sup>	-9 dB – +9 dB <sup>*2</sup>
HighMid Freq.	EQ high-middle frequency	100 Hz – 10.0 kHz
HighMid Q	EQ high-middle resonance	0.1 – 12.0
High Gain	EQ high range gain <sup>*1</sup>	-9 dB – +9 dB <sup>*2</sup>
High Freq.	EQ high frequency	500 Hz – 16.0 kHz
High Q	EQ high resonance	0.1 – 12.0

<sup>\*1</sup> You can also set the EQ Gain by moving the [MASTER EQUALIZER] slider. Keep in mind that the most recently made settings will be effective.

<sup>\*2</sup> You can specify the range of the gain from -12 dB to +12 dB on MIDI Input. The display will also indicate from -12 dB to +12 dB.

**NOTE** If the “Equalizer Lock” parameter (page 71) in the Other Settings menu is turned on, the Master Equalizer settings will not be affected by selecting a Performance, or by Song playback and incoming MIDI data.

# Using the Performance Functions

The Performance functions allow you to store edited Voices, including Dual/Split settings, Voice and effect parameters, MIDI transmit/receive channel settings and Master Edit settings, to the VOICE/PERFORMANCE [1] – [16] buttons. Once they have been saved, the Performances can instantly be recalled from the panel. Refer to the section “Handling Performance Files” on page 76.

You can save up to a total of 64 Performances to the VOICE/PERFORMANCE [1] – [16] buttons. A single button can contain four different Performances, A – D.

To select the desired Performance (A – D), use the VARIATION [▼][▲] buttons.

## Performance file

A Performance file is a single file that includes the data of 64 Performances.

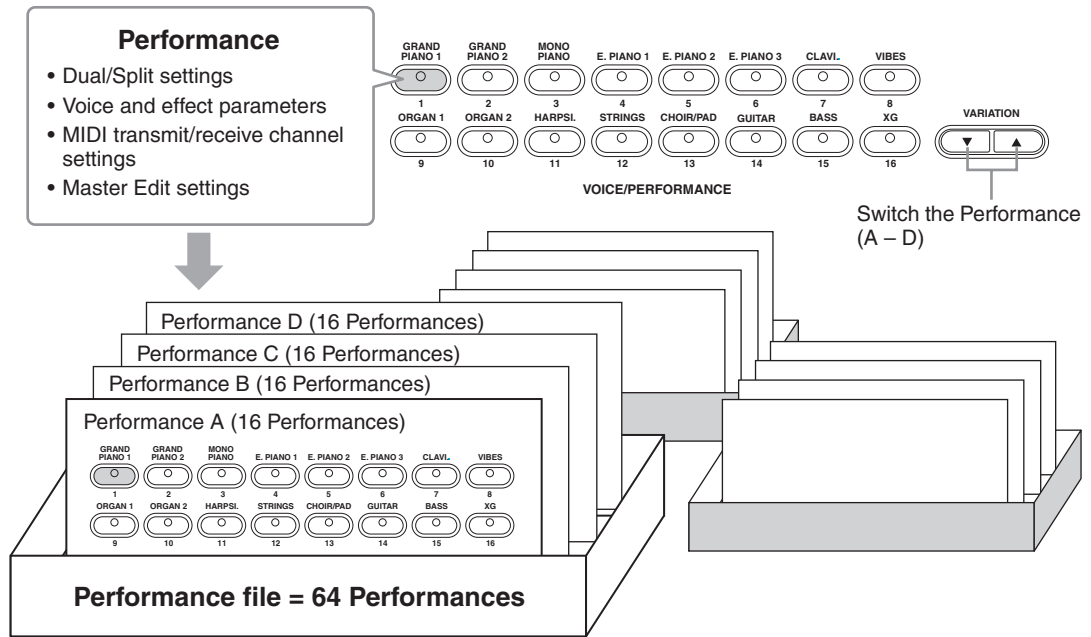

The current Performance, along with data of 64 Performances, is saved to the storage memory. For details about recalling a Performance file from storage memory, refer to page 79.

### Terminology

**Storage memory:** This memory area enables you to save Performance files and recorded Songs.

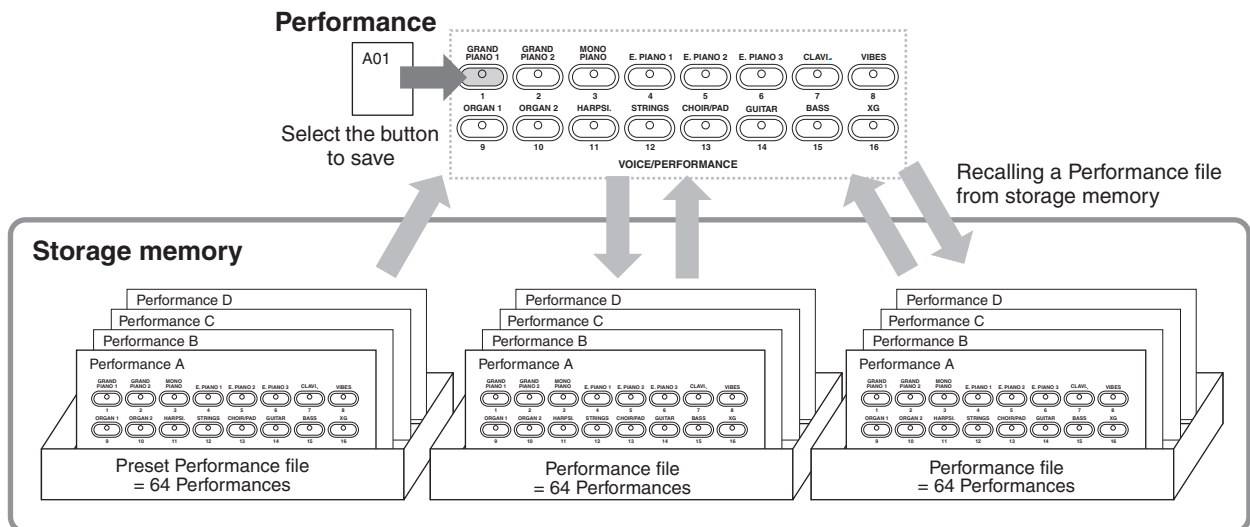

## Performance Parameters

The useful Performance function enables you to store and recall all settings of the entire CP300 together, including Dual/Split settings, Voice and effect parameters, MIDI transmit/receive channel settings and Master Edit settings. Settings that can be edited and stored to a Performance are called “Performance parameters.”

Parameter menu	Contents	Parameter name	Page
VOICE/ PERFORMANCE	Selecting a Voice <sup>*1</sup>	–	25
	Setting Dual	–	29
SPLIT	Setting Split	–	31
REVERB	Turning the Reverb on/off	–	35
MASTER	Turning the Master mode on/off	–	39
TRANPOSE	Turning the Transpose on/off	–	37
VOICE EDIT	Setting the octave <sup>*1</sup>	Octave	58
	Setting the volume level <sup>*1</sup>	Volume	58
	Setting the position of right and left channels <sup>*1</sup>	Pan	58
	Make fine adjustments to the pitch (only in Dual mode) <sup>*1</sup>	Detune	58
	Selecting the Reverb type <sup>*1</sup>	ReverbType	58
	Setting the Reverb send <sup>*1</sup>	ReverbSend	58
	Setting the Chorus type <sup>*1</sup>	ChorusType	59
	Setting the Chorus send <sup>*1</sup>	ChorusSend	59
	Turning the Chorus on/off <sup>*1</sup>	ChorusOnOff	59
	Selecting the Insertion effect type <sup>*1</sup>	Ins.Type	59
	Setting the speed of the Vibraphone vibrato effect <sup>*1</sup>	VibeRotorSpeed	59
	Turning the Vibraphone vibrato effect on/off <sup>*1</sup>	VibeRotorOnOff	60
	Setting the rotation speed of the rotary speed <sup>*1</sup>	RotarySpeed	60
	Adjusting the Insertion effect depth <sup>*1</sup>	Dry/WetBalance	60
	Adjusting the Brightness of the sound <sup>*1</sup>	Brightness	60
	Adjusting the Resonance effect <sup>*1</sup>	HarmonicContent	60
	Adjusting the low-range frequency of the Part equalizer <sup>*1</sup>	EQLowFreq.	60
	Adjusting the high frequency of the Part equalizer <sup>*1</sup>	EQHighFreq.	61
	Adjusting the low-range gain of the Part equalizer <sup>*1</sup>	EQLowGain	60
	Adjusting the high range gain of the Part equalizer <sup>*1</sup>	EQHighGain	61
	Setting the Touch Sensitivity <sup>*1</sup>	TouchSense	61
	Setting the Pedal 1 function <sup>*2</sup>	Pedal1	61
	Setting the Pedal 2 function <sup>*2</sup>	Pedal2	61
	Setting the Pedal 3 function <sup>*2</sup>	Pedal3	61
	Setting the Pedal 4 function <sup>*2</sup>	Pedal4	62
	Setting the Modulation wheel function <sup>*2</sup>	Modulation	62
MASTER EQ EDIT	Selecting the Master equalizer type <sup>*3</sup>	Edit or Master EQ type name	72
	Adjusting the low-range gain of the Master equalizer <sup>*3</sup>	LowGain	
	Adjusting the low-middle range gain of the Master equalizer <sup>*3</sup>	LowMidGain	
	Adjusting the middle range gain of the Master equalizer <sup>*3</sup>	MidGain	
	Adjusting the high-middle range gain of the Master equalizer <sup>*3</sup>	HighMidGain	
	Adjusting the high range gain of the Master equalizer <sup>*3</sup>	HighGain	
	Adjusting the low-range frequency of the Master equalizer <sup>*3</sup>	LowFreq.	
	Adjusting the low-middle frequency of the Master equalizer <sup>*3</sup>	LowMidFreq.	
	Adjusting the middle frequency of the Master equalizer <sup>*3</sup>	MidFreq.	
	Adjusting the high-middle frequency of the Master equalizer <sup>*3</sup>	HighMidFreq.	
Adjusting the high frequency of the Master equalizer <sup>*3</sup>	HighFreq.		

Parameter menu	Contents	Parameter name	Page
MASTER EQ EDIT	Adjusting the low-range resonance of the Master equalizer <sup>*3</sup>	LowQ	72
	Adjusting the low-middle resonance of the Master equalizer <sup>*3</sup>	LowMidQ	
	Adjusting the middle resonance of the Master equalizer <sup>*3</sup>	MidQ	
	Adjusting the high-middle resonance of the Master equalizer <sup>*3</sup>	HighMidQ	
	Adjusting the high resonance of the Master equalizer <sup>*3</sup>	HighQ	
MIDI SETTING	Setting the MIDI transmit channel	MidiOutChannel	65
	Setting the MIDI receive channel	MidiInChannel	65
	Turning Local Control on/off	LocalControl	65
	Selecting Performance from the keyboard or Song data for MIDI transmission	MidiOutSelect	65
OTHER SETTING	Selecting the Touch Response	TouchResponse	68
	Selecting a tuning curve for a Piano Voice	PianoTuningCurve	68
	Selecting a scale	Scale	68
	Specifying the Split Point (Main)	SplitPoint (Main)	69
	Specifying the Split Point 2 (Layer)	SplitPoint2 (Layer)	69
	Changing the key	Transpose	69
	Adjusting the depth of the Soft pedal	SoftPedalDepth	69
	Setting the depth of String Resonance	StringResonanceDepth	69
	Setting the depth of Sustain Sampling for the Sustain pedal	SustainSamplingDepth	69
	Specifying the volume of the Key-off sound	KeyOffSamplingDepth	70
	Selecting a pedal function for Vibraphone Voice	VibraphonePedalMode	70
	Assigning the SONG [PLAY/PAUSE] function to the pedal	PedalPlay/Pause	70
	Setting the point at which the Sustain pedal starts to affect the sound	HalfPedalPoint	70
	Setting the Pitch bend range	PitchBendRange	70
MASTER EDIT	Assigning a function to the [ZONE CONTROL] slider	Slider	54
	Setting the MSB of the Send Bank Select message	SendBankMsb	54
	Setting the LSB of the Send Bank Select message	SendBankLsb	54
	Setting the Program Change message	SendPG#	54
	Setting the octave of the external tone generator	Octave	55
	Turning the internal tone generator on/off	InterITG	55
	Setting the MIDI transmit channel when the Master mode is turned on	MidiOutChannel	55

\*1 The value of the parameter varies depending on the Dual (page 29) and Split (page 31) settings.

\*2 The value of the parameter varies depending on the Split settings (page 31).

\*3 If the Equalizer Lock parameter in the Other Settings menu is turned on, recalling a Performance from the panel will not update the parameter settings (page 71).

# Handling Performance Files

File displays (accessed via the [PERFORM.FILE] button) enable you to handle and organize files (e.g., save, delete and rename Performance files) from the display.

Setting	Parameter name	Page
Saving a Performance	Performance	77
Renaming a Performance	Perf.Name	78
Saving as a Performance file	SaveAs	79
Recalling the Performance file from the storage memory	LoadFromMem.	79
Deleting a Performance file	DeleteFile	80
Renaming a Performance file	RenameFile	80

## Performance File—Basic Operation

A message (information or confirmation prompt) sometimes appears on the display to facilitate operation. Refer to the “Message List” on page 94 for an explanation of each message, along with the appropriate actions to take.

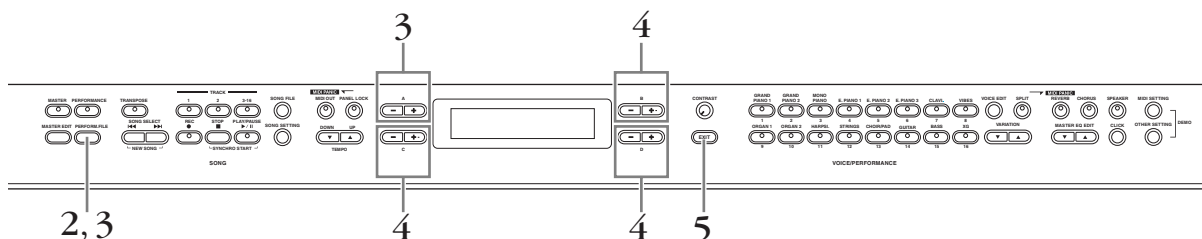

### 1 Prepare the file(s) for handling.

**When using the Performance or Save As parameters:**

Select the edited Voice or Performance file you want to save.

**When using the Perf. Name, Rename File, Load From Mem. and Delete File parameters:**

No operations necessary; go on to Step 2 below.

### 2 Press the [PERFORM.FILE] button to enter the Performance File settings.

### 3 Select the desired item by pressing the [PERFORM.FILE] button or by using the A [-] [+] buttons.

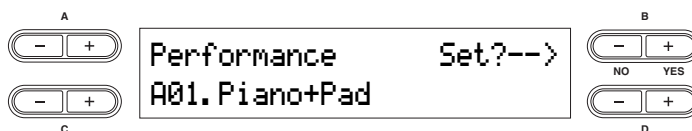

To close the Performance File menu, press the [EXIT] button once or twice.

### 4 Use the B [- (NO)][+ (YES)] to D [-][+] buttons to change the value.

For details about each operation, refer to pages 77 – 80.

### 5 Press the [EXIT] button to exit from the Performance File settings.

## Saving a Performance—Performance

You can save the edited Performance to one of the VOICE/PERFORMANCE [1] – [16] buttons. For details about the parameters you can store to a Performance and their contents, refer to the “Performance Parameters” list (page 74). The Performance data is stored to storage memory as a Performance file. For instructions on recalling a Performance file from storage memory, refer to page 79.

### ⚠ CAUTION

If you create a Performance by editing an existing Preset Performance file, a new Performance file named “PresetPerformance.PER” will be made. The Preset Performance file is not overwritten; however, the edited Performance can be overwritten without any warning. To avoid overwriting the data, save it as another Performance file with the Save As operation or rename the Performance file with Rename File.

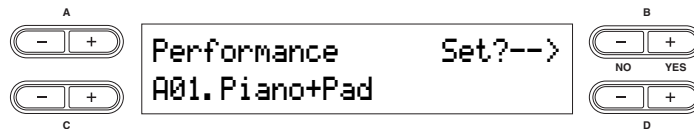

For basic operation instructions, refer to page 76.

The following steps are detailed instructions for Step 4 (in the Basic Operation above).

#### 4-1 Select the desired Performance by using the VARIATION [▼][▲] buttons or the C [-] [+] buttons.

The location for saving the Performance can be specified from A01 to D16.

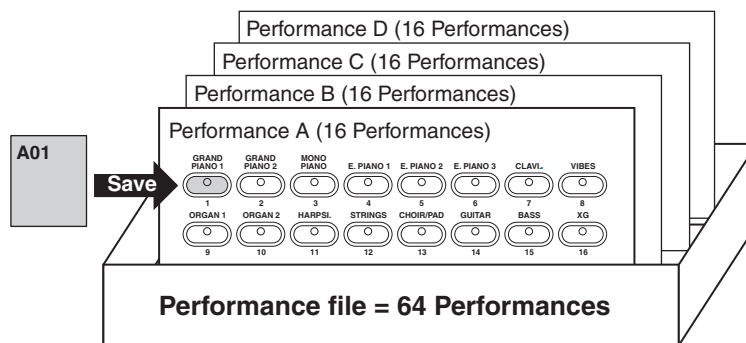

#### 4-2 Press the B [+ (YES)] button to execute the job.

An “Executing” message appears and the data is saved. When the operation is complete, a “Completed” message appears briefly, then returns to the previous display.

### ⚠ CAUTION

Never attempt to turn the [POWER] switch OFF while the “Executing” message is shown in the display. Turning the power off in this state may cause the Performance file to be deleted.

## Renaming a Performance—Perf. Name

This allows you to rename the Performance.

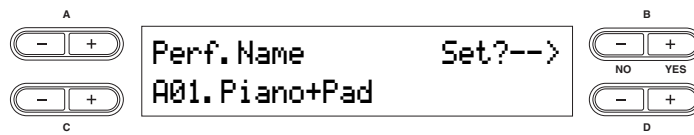

For basic operation instructions, refer to page 76.

The following steps are detailed instructions for Step 4 (in the Basic Operation above).

### 4-1 Renaming a Performance.

To move the cursor (small underline), use the C [-][+] buttons.

To insert a space, press the C [-][+] buttons simultaneously.

To select a character on the cursor, use the D [-][+] buttons.

To delete a character, press the D [-][+] buttons simultaneously.

You can use up to 20 characters for a Performance name.

You can change the type of characters on the display using the “Character Code” parameter in the Song File menu.

### 4-2 Press the B [+ (YES)] button to execute the job.

An “Executing” message appears and the data is saved. When the operation is complete, a “Completed” message appears briefly, then returns to the previous display.

#### CAUTION

Never attempt to turn the [POWER] switch OFF while the “Executing” message is shown in the display. Turning the power off in this state may cause the Performance file to be deleted.



## Saving as a Performance File—Save As

This allows you to save the Performance file as another file, under another file name.

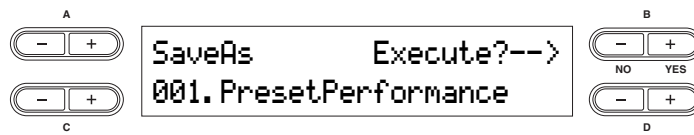

For basic operation instructions, refer to page 76.

The following steps are detailed instructions for Step 4 (in the Basic Operation above).

### 4-1 Name the Performance as described in the “Perf.Name” section (page 78).

### 4-2 Press the B [+ (YES)] button to execute the job.

Press the B [+ (YES)] button to display the confirmation prompt (“Sure?”).

To proceed, press the B [+ (YES)] button again. An “Executing” message appears and the data is saved. When the operation is complete, a “Completed” message appears briefly, then returns to the previous display.

To cancel the operation, press the B [– (NO)] button instead of the B [+ (YES)] button.

If storage memory contains one or more Performance files, and you save a Performance file, the CP300 automatically sorts the Songs alphabetically and renumbers them.

#### CAUTION

Never attempt to turn the [POWER] switch OFF while the “Executing” message is shown in the display. Turning the power off in this state may cause the Performance file to be deleted.

## Recalling the Performance File from the Storage Memory—Load From Memory

This allows you to recall the Performance file from storage memory. A single Performance file consists of 64 separate Performances. The Performance file in the current memory will be replaced with the selected Performance file in the storage memory.

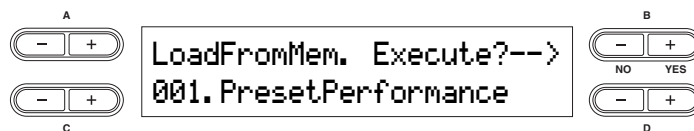

For basic operation instructions, refer to page 76.

The following steps are detailed instructions for Step 4 (in the Basic Operation above).

### 4-1 Use the C [–][+] buttons to select the desired Performance file to be loaded.

### 4-2 Press the B [+ (YES)] button to execute the job.

Press the B [+ (YES)] button to display the confirmation prompt (“Sure?”).

To proceed, press the B [+ (YES)] button again. An “Executing” message appears and the data is saved. When the operation is complete, a “Completed” message appears briefly, then returns to the previous display.

To cancel the operation, press the B [– (NO)] button instead of the B [+ (YES)] button.

#### CAUTION

Never attempt to turn the [POWER] switch OFF while the “Executing” message is shown in the display. Turning the power off in this state may cause the Performance file to be deleted.

**NOTE** The Performance file loaded from the storage memory is effective after restarting the CP300.

## Deleting a Performance File—Delete File

This allows you to delete a Performance file from the CP300's storage memory. It is not possible to delete a Preset Performance file and current Performance file.

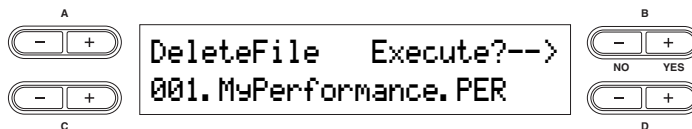

For basic operation instructions, refer to page 76.

The following steps are detailed instructions for Step 4 (in the Basic Operation above).

### 4-1 Use the C [-][+] buttons to select the Performance file to be deleted.

### 4-2 Press the B [+ (YES)] button to execute the job.

Press the B [+ (YES)] button to display the confirmation prompt (“Sure?”).

To proceed, press the B [+ (YES)] button again. An “Executing” message appears and the data is saved. When the operation is complete, a “Completed” message appears briefly, then returns to the previous display.

To cancel the operation, press the B [- (NO)] button instead of the B [+ (YES)] button.

#### CAUTION

Never attempt to turn the [POWER] switch OFF while the “Executing” message is shown in the display. Turning the power off in this state may damage the data of the Performance.

**NOTE** The Performance file in the current memory cannot be deleted. After you delete a Performance file, the CP300 automatically updates the Performance file numbers.

## Renaming a Performance File—Rename File

You can rename a Performance file in the storage memory. You cannot change the Preset Performance file.

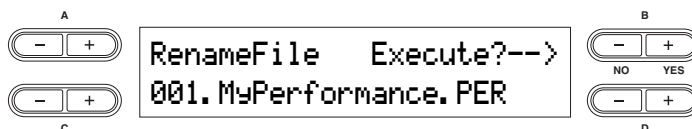

For basic operation instructions, refer to page 76.

The following steps are detailed instructions for Step 4 (in the Basic Operation above).

### 4-1 Name the Performance file as described in the “Perf.Name” section (page 78).

### 4-2 Press the B [+ (YES)] button to execute the job.

After you rename a Performance, the CP300 sorts Performance files alphabetically and renumbers them.

#### CAUTION

Never attempt to turn the [POWER] switch OFF while the “Executing” message is shown in the display. Turning the power off in this state may cause the Performance file to be deleted.

# Handling Song Files

File displays (accessed via the [SONG FILE] button) enable you to handle and organize files (e.g., save, delete and rename Song files) and change characters from the display.

Setting	Parameter name	Page
Saving recorded Songs to the CP300's storage memory	SaveToMemory	82
Deleting a Song from the CP300's storage memory	DeleteSong	83
Renaming Song files	RenameSongs	83
Changing the type of characters in display	CharacterCode	84

## Terminology

**Song file:** On the CP300, a Song file includes both Song data and a Song number.

## Song File—Basic Operation

A message (information or confirmation prompt) sometimes appears on the display to facilitate operation. Refer to the “Message List” on page 94 for an explanation of each message, along with troubleshooting information and the appropriate actions to take.

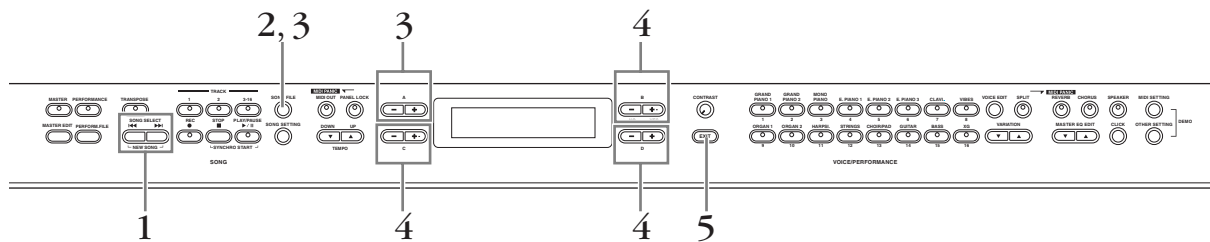

### 1 Prepare the file(s) for handling.

**When using the Save To Memory, Rename Song and Delete Song parameters:**

Use the SONG SELECT [◀◀] [▶▶] buttons to select the target Song.

**When using the Character Code parameter:**

No operations necessary; go on to Step 2 below.

### 2 Press the [SONG FILE] button to access the Song File settings.

### 3 Select the desired item by pressing the [SONG FILE] button or by using the A [-][+] buttons.

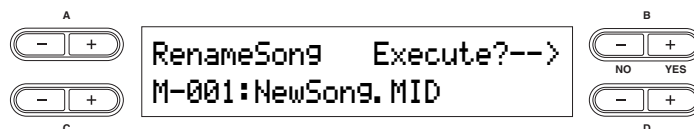

To close the Song File menu, press the [EXIT] button once or twice.

### 4 Press the B [- (NO)][+ (YES)] to D [-][+] button to execute the job or change the value.

For details about each operation, refer to pages 82 – 84.

### 5 Press the [EXIT] button to exit the Song File settings.

## Saving Recorded Songs to the CP300's Storage Memory—Save To Memory

This allows you to save recorded Songs to the CP300's storage memory. Keep in mind that when you turn off the power to the CP300, your recorded Song data will be lost. To permanently save the recorded Song, you must save it to the CP300's storage memory.

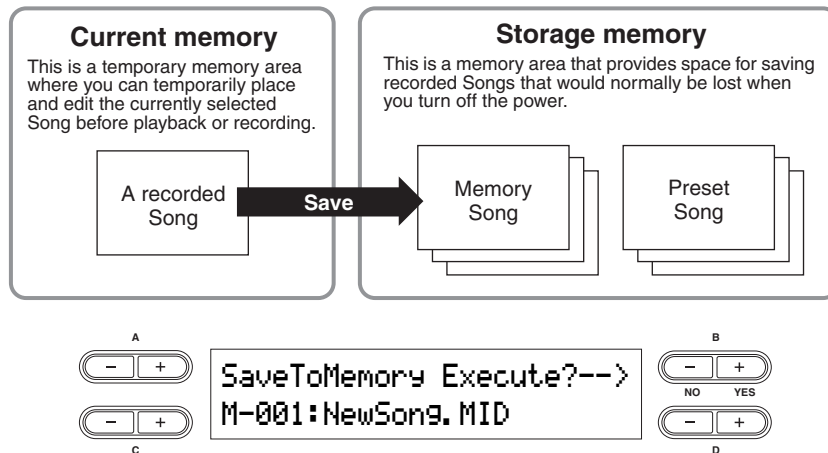

The Save To Memory operation is not available for Preset Songs.

For basic operation instructions, refer to page 81.

The following steps are detailed instructions for Step 4 (in the Basic Operation above).

### 4-1 Name the Song.

To move the cursor (small underline), use the C [-][+] buttons.

To insert a space, press the C [-][+] buttons simultaneously.

To select a character on the cursor, use the D [-][+] buttons.

To delete a character, press the D [-][+] buttons simultaneously.

You can use up to 58 characters for a Song name. If the name is longer than the display, use the C [-][+] buttons to move the cursor and scroll through the name.

You can change the type of characters on the display using the “Character Code” parameter (page 84).

### 4-2 Press the B [- (NO)][+ (YES)] button to execute the job.

Press the B [+ (YES)] button to display the confirmation prompt (“Sure?”).

To proceed, press the B [+ (YES)] button again. An “Executing” message appears and the data is saved. When the operation is complete, a “Completed” message appears briefly, then returns to the previous display.

To cancel the operation, press the B [- (NO)] button instead of the B [+ (YES)] button.

#### CAUTION

Never attempt to turn the [POWER] switch OFF while the “Executing” message is shown in the display. Turning the power off in this state may cause the recorded Song to be deleted.

The Song is automatically numbered as “Mxx,” where “M” stands for “Memory” and “xx” is a number. If storage memory contains one or more Songs, and you save a new Song, the CP300 automatically sorts the Songs alphabetically and renumbers them.

## Deleting a Song from the CP300's Storage Memory—Delete Song

This allows you to delete a Song from the CP300's storage memory. It is not possible to delete a Preset Song.

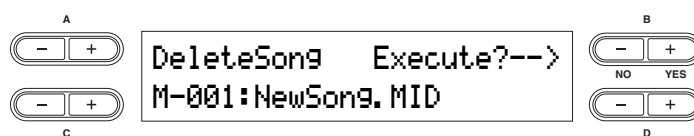

For basic operation instructions, refer to page 85.

The following steps are detailed instructions for Step 4 (in the Basic Operation above).

### 4-1 Use the C [-][+] buttons to select a Song to delete.

### 4-2 Press the B [+ (YES)] button to execute the job.

Press the B [+ (YES)] button to display the confirmation prompt ("Sure?").

To proceed, press the B [+ (YES)] button again. An "Executing" message appears and the data is saved. When the operation is complete, a "Completed" message appears briefly, then returns to the previous display.

#### CAUTION

Never attempt to turn the [POWER] switch OFF while the "Executing" message is shown in the display. Turning the power off in this state may damage the data of the recorded Song.

**NOTE** After you delete a Song, the CP300 automatically updates the Song numbers.

## Renaming Song Files—Rename Song

This allows you to rename Song files. The titles of any Songs can be changed, with the exception of the Preset Songs and "P-000:NewSong."

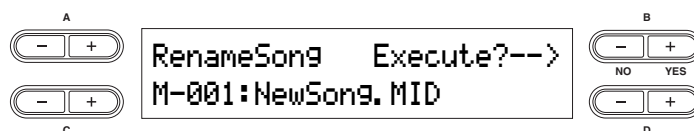

For basic operation instructions, refer to page 81.

The following steps are detailed instructions for Step 4 (in the Basic Operation above).

### 4-1 Name the Song as described in the Save To Memory operation (page 82).

### 4-2 Press the B [+ (YES)] button to execute the job.

After you rename a Song, the CP300 sorts all Songs alphabetically and renumbers them.

#### CAUTION

Never attempt to turn the [POWER] switch OFF while the "Executing" message is shown in the display. Turning the power off in this state may cause the recorded Song to be deleted.

## Changing the Type of Characters in Display—Character Code

This allows you to change the type of characters that appear on display. The instructions below correspond to Step 4 in the Basic Operation on page 81.

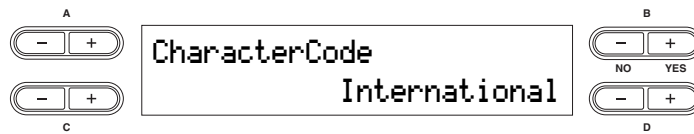

### 4 Use the D [-][+] buttons to select “International” or “Japanese.”

**Settings:** International, Japanese

#### Character List

Japanese

0~9	A~Z	a~z	ア	ン	ア	オ	ヤ	ユ	ヨ	ツ	ゝ	°	ー	。	「	」	、	・	!	#	\$	%	&	'	(	)	+	,	-	.	;	=	@	[	]	^	_	`	{	}	~
-----	-----	-----	---	---	---	---	---	---	---	---	---	---	---	---	---	---	---	---	---	---	----	---	---	---	---	---	---	---	---	---	---	---	---	---	---	---	---	---	---	---	---

International

0~9	A~Z	a~z	Ä	Ë	Ï	Ö	Ü	ä	ë	ï	ö	ü	à	è	ì	ò	ù	á	é	í	ó	ú	â	ê	î	ô	û	Ñ	ñ	ß	Ç	ç	°	ı	ı	!	#	\$	%	&	'	(	)	+	,	-	.	;	=	@	[	]	^	_	`	{	}	~
-----	-----	-----	---	---	---	---	---	---	---	---	---	---	---	---	---	---	---	---	---	---	---	---	---	---	---	---	---	---	---	---	---	---	---	---	---	---	---	----	---	---	---	---	---	---	---	---	---	---	---	---	---	---	---	---	---	---	---	---

**NOTE** File names using the characters shown in gray above will not display correctly if the Character Code setting has been changed.

**NOTE** The Character Code setting is also reflected in the display for the Performance and Performance file names.

# Settings for Song Recording and Playback— Song Settings

From this menu, you can make detailed settings for the selected Song. First, select the desired Song (page 49).

## Song Settings—Basic Operation

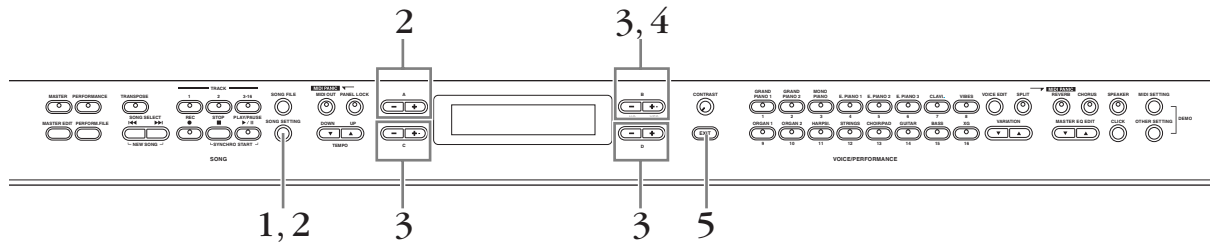

- 1 Press the [SONG SETTING] button to access the Song Settings menu.
- 2 Select the desired item by pressing the [SONG SETTING] button or by using the A [-][+] buttons.

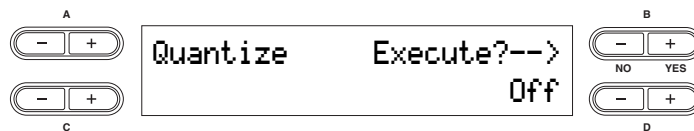

- 3 Use the B [- (NO)][+ (YES)] to D [-][+] buttons to execute the job or change the value. Press the [-][+] buttons simultaneously to instantly reset to the default setting.
- 4 Press the B [+ (YES)] button to execute the job, if an “Execute?” or “Start?” prompt appears.  
Press the B [+ (YES)] button to display the confirmation prompt (“Sure?”).  
To proceed, press the B [+ (YES)] button again. An “Executing” message appears and the data is saved. When the operation is complete, a “Completed” message appears briefly, then returns to the previous display.  
To cancel the operation, press the B [- (NO)] button instead of the B [+ (YES)] button.
- 5 Press the [EXIT] button to exit from the Song Settings menu.

**NOTE** Save the edited Song data by using the “Save To Memory” operation in the Song File menu.

## Parameters

### Quantize

This allows you to correct the timing of notes you've recorded. For example, if the timing of your performance was slightly off in places, you can adjust the notes to precise eighth or sixteenth notes. Changes made in Quantize affect the entire Song.

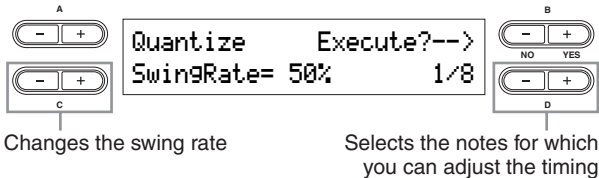

Changes the swing rate

Selects the notes for which you can adjust the timing

#### Quantize timing settings (according to note value):

Off

- 1/4 ..... Quarter note
- 1/8 ..... Eighth note
- 1/12 ..... Eighth note triplets
- 1/16 ..... Sixteenth note
- 1/24 ..... Sixteenth note triplets

If you select "1/8" or "1/16" for correction, the Swing Rate parameter is shown (as a percentage value). Changing the Swing Rate will make the Song sound more lively and give it more of a swing or jazzy feel.

**Setting range:** 0% – 100%

#### If you select "1/8" for correction:

Your keyboard performance



Swing rate = 50%: No swing; straight

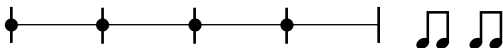

Swing rate = 75% (51% or higher): The timing of even beat notes is slightly delayed.



Swing rate = 25% (49% or lower): The timing of even beat notes is slightly early.

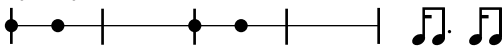

Swing rate = 67%: The timing of even beat notes is moved to the third beat of the triplets.

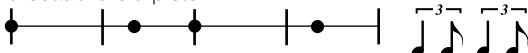

**Default setting:** Off

### Quick Play

This allows you to specify whether a Song that starts at a point other than the first beat of the first measure should be played from the first actual note or from the beginning of the Song. (Some Songs are recorded with initial settings and non-note data at the very beginning of the Song; this parameter allows you to skip those settings and play the Song from the first note. It also allows you to skip over rests that naturally occur before the pickup note in a Song.)

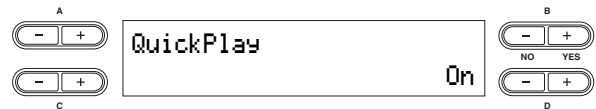

#### Settings:

On	Playback from the first note
Off	Playback from the start of the Song (including a rest or blank measure)

**Default setting:** On

### Channel Listen

This allows you to select and audition the recorded contents of a single channel. Playback starts from the first note.

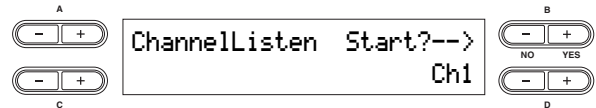

**Setting range:** Ch 1 – Ch 16

**Default setting:** Ch 1

**NOTE** Song data consists of 16 channels. Each instrument part is assigned to a specific channel, so for this instrument, the words "channel" and "track" have the same meaning.

**NOTE** Channels that do not contain any data are not displayed. However, for some Songs, all channels (including the channels that contain no data) may be displayed.

### Channel Clear

This allows you to delete data of a single specified channel, or of all 16 channels at once.

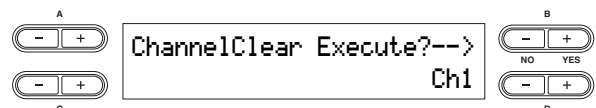

**Setting range:** Ch 1 – Ch 16, ALL (all channels)

**Default setting:** Ch 1

**NOTE** Song data consists of 16 channels. Each instrument part is assigned to a specific channel, so for this instrument, the words "channel" and "track" have the same meaning.



**NOTE** Channels that do not contain any data are not displayed. However, for some Songs, all channels (including the channels that contain no data) may be displayed.

**NOTE** When you clear all channels using the “ALL” parameter, you can overwrite the Song. In this case, an empty Song file having no channel data is saved.

### From/To Repeat

This allows you to specify a section within a Song and play it back repeatedly. The section can be specified freely (in measures/beats), and playback repeats after it reaches the point just prior to the beat specified as the end point. If you start playing back a Song with “Repeat On” selected, a lead-in count starts, followed by the repeated playback of the specified part until you press the [STOP] button. If you select “Repeat Off,” normal playback starts.

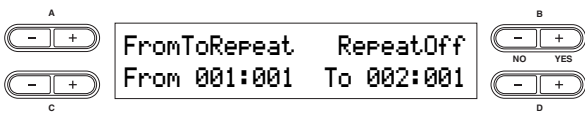

**Settings:** RepeatOn, RepeatOff

**Default setting:** RepeatOff

If you select “Repeat On,” use the C [-][+] and D [-][+] buttons to specify the range to be repeated during Song playback.

**NOTE** When you select another Song, the specified range is automatically cancelled and the Repeat function is turned off.

### Song Repeat

This allows you to repeatedly play back all Songs or a single Song selected from storage memory.

When you start playback, the CP300 plays the Song you selected from the front panel, then starts repeat playback of the specified Songs until you press the [STOP] button. Press the [STOP] button to return to the top of the Song.

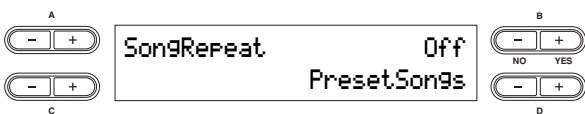

**Settings:**

PresetSongs	All Preset Songs
All	All Memory Songs and Preset Songs
OneSong	One Song selected from the front panel
MemorySongs	All recorded Songs

**Default setting:** PresetSongs

### Time Signature

This allows you to set the time signature of the click. Specify the numerator of the time signature by using the C [-][+] buttons and specify the denominator by using the D [-][+] buttons. For example, to specify 3/4 time, use the C [-][+] buttons to select “3” and the D [-][+] buttons to select “4.”

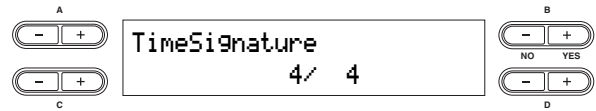

**Setting range for the numerator:** 1 – 16

**Setting options for the denominator:** 2, 4, 8

**Default setting:** 4/4

### Click Volume

This allows you to set volume of the click sound.

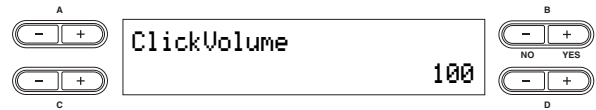

**Setting range:** 0 – 127

**Default setting:** 100

### Click Type

This allows you to select whether the click sound has a bell accent, or plays only a click sound.

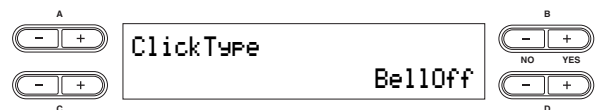

**Setting range:**

BellOff	Click (standard click sound)
BellOn	Click and bell

**Default setting:** BellOff

# Connecting to a Computer and Other MIDI Devices

## ⚠ CAUTION

First, make sure that all volume settings are turned down all the way to the minimum. Then turn on the every device in your setup in the order of MIDI master (controllers), MIDI slaves (receivers), then audio equipment (mixers, amplifiers, speakers, etc.).

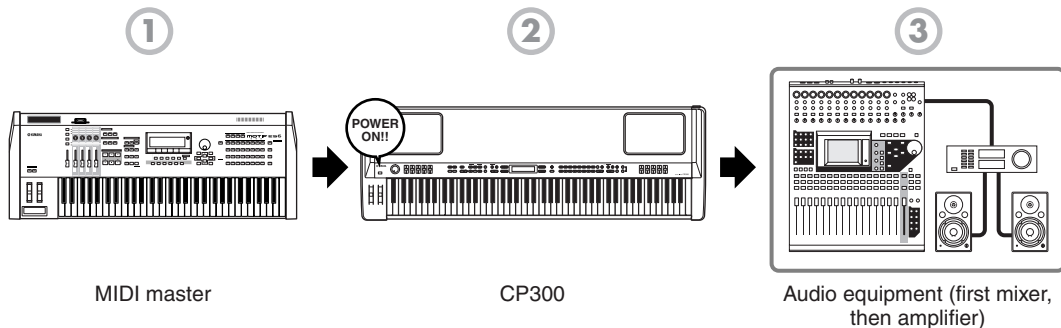

When powering down the setup, first turn down the volume for each audio devices, then switch off each device in the reverse order (first audio devices, then MIDI).

## Connecting to External Audio Equipment

The CP300 has built-in speakers. You can also monitor the sound of the instrument by using external equipment. Connect a set of headphones, powered speakers, or other playback equipment as required. There are several methods of connecting to external audio equipment, as described in the following illustrations. The following illustrations show various connection examples; use the one most similar to your intended setup.

### Connecting Stereo Powered Speakers

For optimum, accurate reproduction of the instrument's rich sounds, effects and full stereo image, use a pair of powered speakers. Connect the powered speakers to the OUTPUT L/MONO and R jacks on the rear panel.

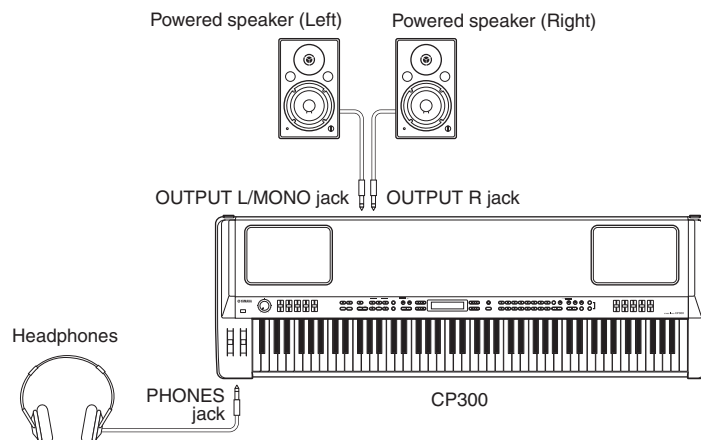

**NOTE** When using just one powered speaker, connect it to the OUTPUT L/MONO jack on the rear panel.

**NOTE** If you are connecting only to the L/MONO jack and want to use a Piano Voice, we recommend that you use the Mono Piano 1 or Mono Piano 2 Voice for best results.

## Connecting to a Mixer

These are extra audio outputs in addition to the main OUTPUT L/R jacks.

The CP300 also features professional-use balanced XLR connectors for the OUTPUT L/R jacks. This type of connector is used in professional studio equipment and installations.

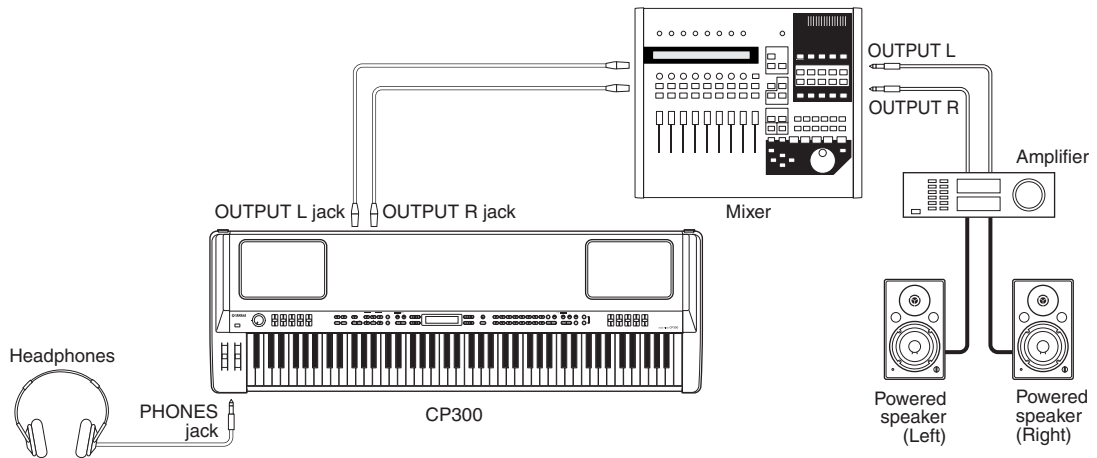

- NOTE**
- Connecting a pair of headphones does not affect audio output from the OUTPUT L/R and OUTPUT L/MONO, R jacks. You can adjust the volume of the external audio equipment, built-in speakers or headphones with the [MASTER VOLUME] dial.
  - The sound monitored through the headphones is identical to the sound of the OUTPUT L/R and OUTPUT L/MONO, R jacks.

### About the OUTPUT L/R jacks

These XLR connectors carry a balanced signal output, and are intended for use in professional studios and installations. If the corresponding circuitry is designed properly, however, XLR-type connectors will also handle unbalanced signals with no problem. Microphone cables usually have this type of connector, as do the inputs and outputs of most professional audio gear.

## Connecting to External Equipment

The CP300 also features a set of INPUT jacks. The stereo outputs from another instrument can be connected to these jacks, allowing you to play the sound of an external instrument through the CP300's speakers. Connect the outputs from the other instrument to the INPUT L/MONO and R jacks on the rear panel.

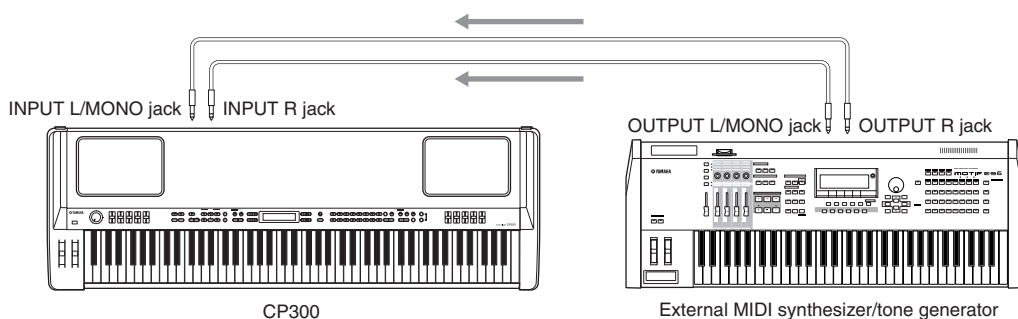

The sound of an instrument connected to these INPUT jacks cannot be adjusted from the CP300. Any level adjustments must be done from the instrument itself.

## Connecting to External MIDI Equipment

Using a standard MIDI cable (available separately), you can connect an external MIDI device, and control it from the CP300. Likewise, you can use an external MIDI device (such as a keyboard or sequencer) to control the sounds on the CP300. Below are several different MIDI connection examples; use the one most similar to your intended setup.

**NOTE** The CP300 cannot receive or transmit MIDI start (FAh), Continue (FBh), or Stop (FCh) messages.

### Controlling from an External MIDI Keyboard

Use an external keyboard or synthesizer (such as the MOTIF ES) to remotely select and play the Voices of the CP300.

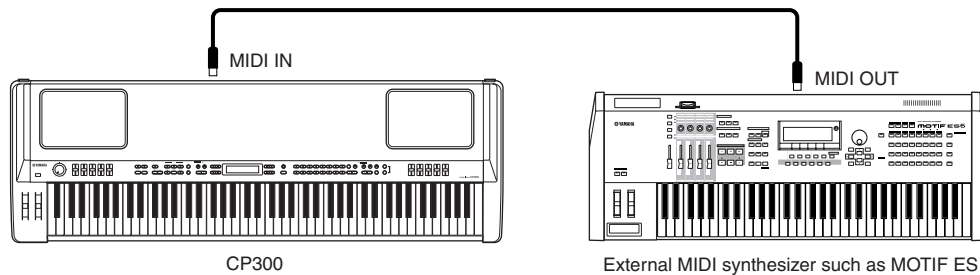

**NOTE** The CP300 can playback commercially available Song data or Song data created for other instruments or on a computer. For details about MIDI data compatibility, refer to page 100.

**NOTE** In order to have an external MIDI device control separate parts of the CP300's internal tone generator, you'll need to change the "MIDI In Channel" parameter in the MIDI Setting menu. For details, refer to page 65.

#### MIDI Transmit Channel and Receive Channel

Make sure to match the MIDI Transmit Channel of the external MIDI instrument with the MIDI Receive Channel of the CP300. For details on setting the MIDI Transmit Channel of the external MIDI instrument, refer to the Owner's Manual of the MIDI instrument.

When setting the MIDI Receive Channel of the CP300, confirm the MIDI Receive Channel for each part and change the settings of the desired parts, if necessary, to match the MIDI Transmit Channel settings on the external MIDI instrument. (Refer to page 65.)

## Controlling an External MIDI Keyboard

This connection lets you play the sounds of an external MIDI tone generator (synthesizer, tone generator module, etc.) from the keyboard of the CP300. Use this connection to play the sounds of the connected instrument in a layer with the CP300, or use the sophisticated Zone functions (page 39) to set up splits in the sounds.

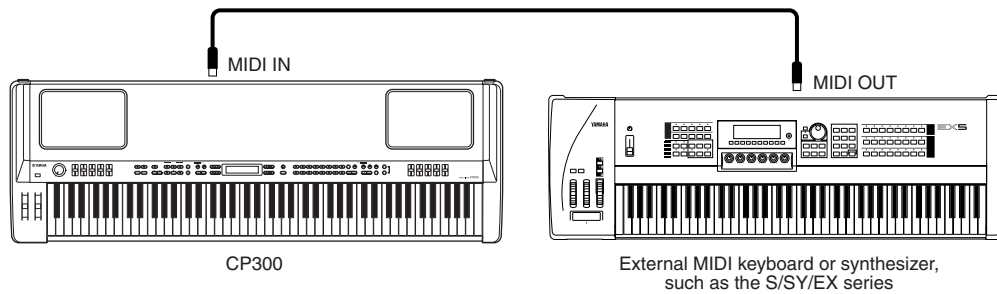

### Splitting the Sound between the CP300 and an External Tone Generator by MIDI Channel

Using the connection example shown above, you can play both instruments and have them separately sound different parts. To use this feature, you must set the CP300's output channel and the external tone generator's receive channel to the same channel number. Set the MIDI Transmit Channel via the "MIDI Out Channel" parameter in the MIDI Settings menu while turning on the power (page 65). While the Master mode is turned on, set the MIDI Transmit Channel via the "MIDI Out Channel" parameter in the Master Edit menu (page 55).

## Controlling Another MIDI Device via MIDI THRU

MIDI THRU simply re-transmits the MIDI messages received via MIDI IN. In the example below, the MIDI messages generated by playing an external keyboard are transmitted to an external tone generator via the MIDI THRU connector on the CP300. The MIDI data of your performance on the CP300 are transmitted to an external device via the MIDI OUT connector on the CP300.

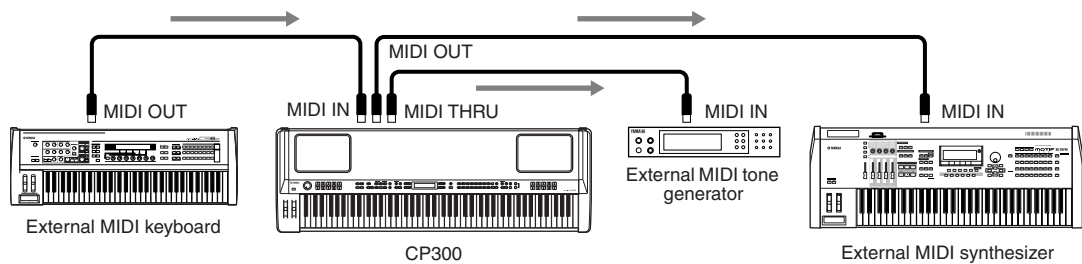

## Connecting to a Computer

Connecting this instrument to a computer via MIDI opens up a whole world of musical possibilities—such as using sequencer software to record and play back compositions with the CP300 sounds.

In order to use the instrument with a computer via a USB connection, you will need to install an appropriate USB-MIDI driver. You can download the proper driver from our website:

<http://download.yamaha.com>

- Information on system requirements can also be found on the above web page
- The USB-MIDI driver may be revised and updated without prior notice. Before installing, visit the above web page to confirm the latest related information and ensure that you have the most up-to-date version.

## Using a USB Cable

MIDI messages can be transferred between the sequencer software and CP300 using the USB cable. However, audio data cannot be transmitted or received via USB on the CP300.

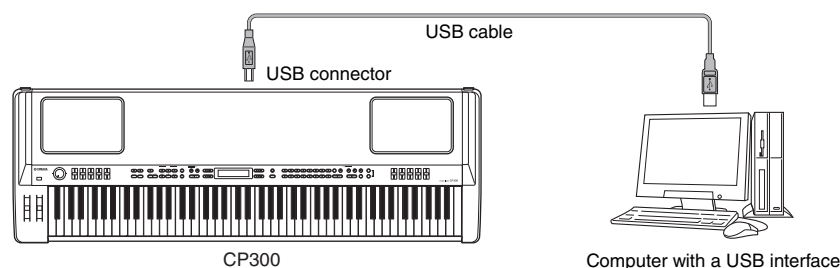

When the USB connector is connected, the MIDI connectors cannot be used.

### Precautions when using the USB connector

When connecting the computer to the USB connector, make sure to observe the following points. Failing to do so risks freezing the computer and corrupting or even losing the data. If the computer or the instrument freezes, turn the power to the instrument off or restart the computer.

#### CAUTION

- Before connecting the computer to the USB connector, exit from any power-saving mode (such as suspended, sleep, standby) of the computer.
- Before turning on the power to the instrument, connect the computer to the USB connector.
- Execute the following before turning the power to the instrument on/off or plugging/unplugging the USB cable to/from the USB connector.
  - Quit any open applications (such as Voice Editor, Multi Part Editor, and sequencer software).
  - Make sure that data is not being transmitted from the instrument. (Data is transmitted only by playing notes on the keyboard or playing back a song.)
- While a USB device is connected to the instrument, you should wait for six seconds or more between these operations: (1) when turning the power of the instrument off then on again, or (2) when alternately connecting/disconnecting the USB cable.
- Use a USB cable less than 3 meters in length.

### Selecting Voices from a Computer

You can select Voices on this instrument from your computer software by specifying the following MIDI messages.

- Bank Select MSB
- Bank Select LSB
- Program Change

For details on what values are assigned to the Voice Bank/Number of this synthesizer, refer to the “Program Change List” on page 105.

## Using Local On/Off when connected to a computer

When connecting the CP300 to a computer, the keyboard performance data is generally sent to the computer, and then returned from the computer to play the tone generator block on the CP300. If the Local Control parameter in the MIDI Settings menu is set to “on,” a “double” sound may result, since the CP300 tone generator is receiving performance data from both the keyboard directly and the computer.

Use the setting suggestions below as a guideline; specific instructions may differ depending on your computer and the software used.

### When MIDI Echo (MIDI Thru) is enabled on the software/computer:

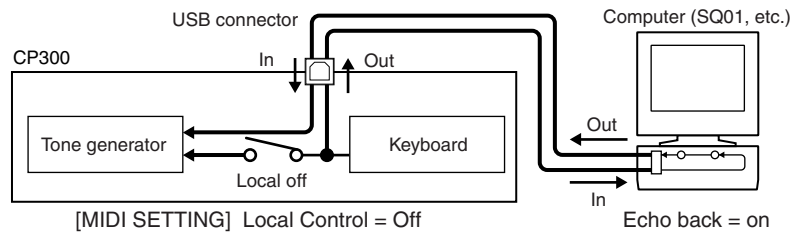

**NOTE** When transmitting or receiving System Exclusive data (such as with the Bulk Dump function), use the setting example below, making sure that MIDI Echo on the computer software is set to “off.”

### When MIDI Echo (MIDI Thru) is disabled on the software/computer:

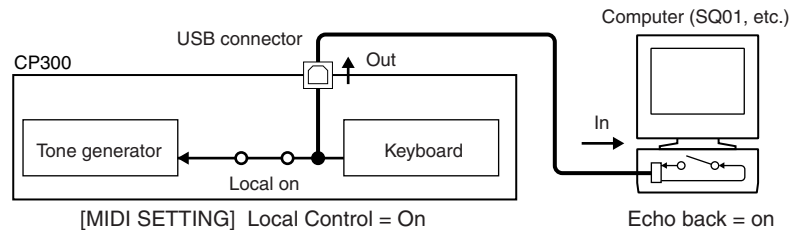

\* MIDI Echo is a function on sequencers that takes any data received via the MIDI IN and “echoes” it (or sends it as is) through the MIDI OUT. In some software, this function is also called “MIDI Thru.”

**NOTE** For details about MIDI Echo, refer to the owner’s manual of your particular software.

# Appendix

## Message List

The messages are listed in alphabetical order.

Message	Description
BulkDataReceiving Completed	<b>Bulk data reception has been completed.</b> This is shown following the "Bulk Data Receiving Voice" message. This indicates that the instrument finished receiving bulk data, and that you can go on to the next step.
BulkDataReceiving Error	<b>Bulk data reception has failed.</b> Check that the cable connection is secure and try again.
BulkDataReceiving	<b>The instrument is receiving bulk data while this message is displayed.</b> Wait until the message closes, then go on to the next step.
BulkDump            Error	<b>The instrument failed to transmit the bulk data.</b> If this message appears, make sure that the power of your computer has not been turned off, that the cable is connected correctly, and that the driver on your computer is functioning correctly. Then try transmitting the data once again.
Canceled	<b>This is shown when the operation has been canceled.</b>
Completed	<b>The operation is completed.</b> This is shown following the "Executing" message. The instrument's internal processing is complete. You can go on to the next step.
DataFmtErr	<b>The file format is invalid.</b> This message appears when the Performance file selected via "Load From Mem." (page 79) is invalid and cannot be called up.
DuplicatedName	<b>The Song name or Performance name is duplicated.</b> You tried to save a Song file after changing its name using the "Rename Song" (page 83), or a Performance file after changing its name using the "Rename File" (page 80) parameter, but a Song or Performance with the same name already exists in memory. The instrument returns to the previous display after three seconds. Rename the Song correctly.
Execute?-->	<b>Do you wish to execute the operation?</b> This message prompts you to execute a file-related operation. Press the B [+ (YES)] button to save the settings. Press the B [- (NO)] or [EXIT] button to cancel.
Executing	<b>The instrument is processing the data internally.</b> Wait until the message closes, then proceed to the next step.
FactorySet    Completed MemoryFileExcluded	<b>The factory default settings, excepting files stored to storage memory (refer to "Factory Set" on page 71), have been restored.</b> This message also appears if you press and hold down the C7 key and turn on the power to the instrument (page 17).
FactorySet    Completed MemoryFileIncluded	<b>The factory default settings, including files stored to storage memory (refer to "Factory Set" on page 71), have been restored.</b> This message also appears if you press and hold down the C7 and B $\blacktriangleright$ 6 keys and turn on the power to the instrument (page 17).



Message	Description
FlashMemoryLifeTime Exit-->	<p><b>The instrument's flash memory (storage memory) has expired.</b> Consult your Yamaha dealer. If this message appears, the instrument will not be able to back up the Songs, Performance files and settings in memory. Press the [EXIT] button to return to the original display.</p>
HostError	<p><b>There is a problem with the USB connector.</b> The power to the computer is turned off, the cables are connected incorrectly, or the driver or MIDI application on the computer is working incorrectly. In this situation, turn the power off to both the instrument and the computer, and check the cable connection. Then, turn on the power to the computer and the instrument in this order and check to see if the driver and MIDI application on the computer work properly.</p> <p>This message is also shown if the USB cable is connected to the instrument without being connected to your computer. When you wish to use the instrument alone, turn off the power of the instrument, disconnect the USB cable from the instrument, then turn the power on again. If the cable is left connected in this condition, the instrument may not function properly.</p>
LastPowerOffIllegal MemoryFileChecking	<p><b>The power was incorrectly turned off the previous time. The instrument is checking the internal memory.</b> You turned off the power to the instrument while it was writing data to storage memory. This message appears next time you turn on the power. The internal memory is being checked while this message is displayed. If it has been confirmed that any files in the storage memory are corrupted, all the files will be deleted.</p>
LastPowerOffIllegal MemoryFileErrorRecovered	<p><b>Some files in the storage memory have been restored.</b> This message appears following the message "Last Power Off Illegal / Memory File Checking," indicating that the instrument recovered as much data in the storage memory as possible.</p>
LastPowerOffIllegal MemoryFileErased	<p><b>Files on the storage memory have been deleted.</b> This message appears following the message "Last Power Off Illegal / Memory File Checking," indicating that the instrument could not recover data in the storage memory and that all memory files were deleted.</p>
MemoryError	<p><b>A memory problem has occurred.</b> While a Song or a Performance file was being loaded, the instrument detected defects in memory. Reset the instrument to its normal (factory default) settings with "Memory File Included" (page 71) after you back up all Song data.</p>
MemoryError	<p><b>There may be a memory problem.</b></p> <ol style="list-style-type: none"> <li>1. This message indicates that there may be a problem with the memory when selecting a Song or Performance file. If the message appears repeatedly when you continue using the instrument, back up the Song data, then restore the default setting by using "Memory File Included" in "Factory Set" (page 71).</li> <li>2. This message will appear if a different "Character Code" (page 84) is selected than was when you assigned the Performance file name. In this case, switch the "Character Code," re-select the Performance file.</li> </ol>
MemoryFull	<p><b>There is no more available space in storage memory.</b> There is not enough memory space left and you cannot save any more Songs or Performance files. Delete some Songs or Performance files in the storage memory (pages 80, 83), then save the new data to memory.</p>
NoSong	<p><b>There is no Song to be saved.</b> This message will appear if there is no Song for the "Save To Memory" (page 82) operation to save. In this case, no Song will be saved.</p>
NoFileToDelete	<p><b>There is no file to be deleted.</b> You tried to delete a file that does not exist in the storage memory. You cannot delete the file.</p>
NoSongToDelete	<p><b>There is no Song to be deleted.</b> You tried to delete a Song that does not exist in the storage memory. The Song cannot be deleted.</p>

Message	Description
OverWrite?	<p><b>Do you want to overwrite the data?</b></p> <p>This message prompts you to select whether you wish to overwrite the existing data with new data. Press the B [+ (YES)] button to allow overwriting. Press the B [- (NO)] button to cancel.</p>
PleaseWait	<p><b>Please wait.</b></p> <p>You tried to start playing a Song or perform another operation right after selecting the Song. Wait until the message closes.</p>
ProtectedFile	<p><b>This is a protected file.</b></p> <p>You tried to copy or delete data in internally-protected files (such as commercially available music data). You cannot write to, copy, or delete such files.</p>
ProtectedSong	<p><b>This is a protected Song.</b></p> <p>This message appears when you try to change the name of an internally-protected Song (Preset Song). You cannot change the name of such Songs.</p>
Set?-->	<p><b>Is the setting maintained?</b></p> <p>This message prompts you to select whether you wish to save the edited settings or not. Press the B [+ (YES)] button to save the settings. Press the [EXIT] button to cancel.</p>
SongChanged Save?	<p><b>The Song has been changed. Do you wish to save the Song?</b></p> <p>You tried to perform another operation before saving the recorded Song to storage memory. If you continue the operation, the recorded Song will be lost. To delete the new recording, press the B [- (NO)] button. To keep the recording, press the B [+ (YES)] button. The "Save To Memory" (page 82) parameter is shown in the display. Save the Song then try the operation again.</p>
SongError	<p><b>An error has been found in the Song data.</b></p> <ol style="list-style-type: none"> <li>1. The instrument has found some defects in the selected (or playing) Song. Select the Song and play it again. If you still see this message, the Song data may be damaged.</li> <li>2. This message will appear if a different "Character Code" (page 84) is selected than was when you assigned the Song name. In this case, switch the "Character Code," re-select the Song, and play it back.</li> </ol>
SongError	
SongTooBig	<p><b>The Song data is too large.</b></p> <ol style="list-style-type: none"> <li>1. The Current memory space has become full during recording. Recording stops automatically. The data recorded up to that point remains. This message also appears when you try to enter recording mode to perform additional recording but the Song data has already filled the current memory. In this case, you cannot perform additional recording. Use the "Channel Clear" parameter (page 86) to delete unnecessary tracks (if any) to make more room in memory.</li> <li>2. The size of the selected Song is larger than the current memory. The instrument cannot load/play the selected Song. Select another Song.</li> <li>3. This message is shown when you edit a Song if that Song is larger than the capacity of the current memory. This Song cannot be edited on the instrument.</li> </ol>
SongTooBig	
Start?-->	<p><b>Do you wish to start the operation?</b></p> <p>This message prompts you to start the operation. To start, press the B [+ (YES)] button. Press the [EXIT] button to cancel the operation.</p>
Sure?-->	<p><b>Are you sure?</b></p> <p>This message prompts you to confirm the execution. Press the B [+ (YES)] button to continue. Press the B [- (NO)] button to cancel.</p>
Transmitting	<p><b>MIDI bulk data is being transmitted.</b></p> <p>This message appears when the instrument receives a bulk request from a computer. This message appears while the bulk data is being transmitted. Wait until the message closes, then go on to the next step. Please wait.</p>
Transmitting Completed	<p><b>Bulk data transmission has been completed.</b></p> <p>This is shown following the "Transmitting" message. It is displayed when the transmission of the bulk data has been completed. You can go on to the next step.</p>

Message	Description
<div style="border: 1px solid black; padding: 5px; width: fit-content;">Transmitting Error</div>	<p><b>MIDI Bulk data is being transmitted.</b></p> <p>This message appears when the instrument receives a bulk request from a computer. The instrument has failed to transmit Voice bulk data. Check the cable connection and repeat the procedure from the beginning.</p>
<div style="border: 1px solid black; padding: 5px; width: fit-content;">WrongName</div>	<p><b>The Song name or Performance file name is not appropriate.</b></p> <ol style="list-style-type: none"> <li>1. This message appears when you have used a period or space at the beginning of a Song name/Performance file (while handling a Song/Performance file), or you have tried to change a Song name by including a character (or characters) not supported by the instrument. The instrument returns to previous display after three seconds. Make sure to enter a valid name.</li> <li>2. This message will appear if a different "Character Code" (page 84) is selected than was when you assigned the Song name or Performance file name. In this case, switch the "Character Code," re-select the Song or Performance file.</li> </ol>

# Troubleshooting

Problem	Possible causes	Solution
The power of the instrument does not turn on.	The instrument has not been plugged in properly.	Securely insert the female plug into the socket on the instrument, and the male plug into a proper AC outlet (page 11).
A click or pop is heard when the power is turned on or off.	This is normal when electrical current is being applied to the instrument.	This is normal.
Noise is heard from the instrument's speakers.	The noise may be due to interference caused by the use of a mobile phone in close proximity to the instrument.	Turn off the mobile phone, or use it further away from the instrument. Using a mobile phone in close proximity to the instrument may produce interference.
The overall volume is too low, or there is no sound at all.	The [MASTER VOLUME] (page 13) may be set too low.	Raise the [MASTER VOLUME] level.
	The [ZONE CONTROL] (page 28) may be set too low.	Raise the [ZONE CONTROL] slider.
	Speaker setting may be off.	Turn on the [SPEAKER] button (page 52).
	"Local Control" (page 65) may be set to off.	Set "Local Control" to on.
	"Internal TG" (page 55) may be set to off.	Set "Internal TG" to on.
	The pedal or the Modulation wheel is set to minimum, when "Expression" is assigned to the foot controller or Modulation wheel.	Change the position of the pedal or Modulation wheel.
	"Expression" may have been assigned to one of the connected footswitches.	Assign any function other than "Expression" to the footswitch.
	The gain setting of the Master EQ (page 36) may be low.	Raise the gain of the Master EQ.
	The gain of the Part EQ (page 36) may be low.	Raise the gain of the Part EQ.
The keyboard volume is low.	"Volume" may have been assigned to the [ZONE CONTROL] slider while the Master mode is turned on, the [ZONE CONTROL] may be set too low.	Raise the [ZONE CONTROL] slider.
	The volume level for the keyboard Performance may be set too low.	Raise any of the [ZONE CONTROL] slider.
The Song playback volume is low.	The volume of the Song playback may be set too low.	Raise the [SONG VOLUME] slider.
The speakers do not switch off when a pair of headphones is connected.	Speaker setting may be On.	Set the Speaker setting to Off.
The pitch and/or tone of the Piano Voices in certain ranges do not sound right.	The Piano Voices attempt to precisely simulate actual piano sounds. However, as a result of sampling algorithms, overtones in some ranges may sound exaggerated, producing a somewhat different pitch or tone.	This is normal.
Mechanical noise is heard during Performance.	The keyboard mechanism of this instrument simulates the keyboard mechanism of an actual piano. Mechanical noise is also heard on a piano.	This is normal.
The buttons do not respond.	While you are using a function, some buttons not used for the function are disabled.	If a Song is playing or recording, stop playback or recording. Otherwise, press the [EXIT] button to return to the main display, and then perform the desired operation.
	The Panel Lock function is effective.	Rapidly press the [PANEL LOCK] button twice to cancel the Panel Lock.

Problem	Possible causes	Solution
The sound sustains and does not decay while pressing the pedal to which the sostenuto function is assigned.	For Voices in the ORGAN, STRINGS, CHOIR, PAD, and XG groups, the sound continues sustaining while you are holding down the sostenuto pedal.	This is normal.
Higher or lower notes do not sound correctly when the transpose or octave setting is made.	The setting range for the transposition and octave setting is C-2 – G8. (With the normal setting, the 88 keys of this instrument cover the range of A-1 – C7.) If the lowest key is set to a note lower than C-2, it will produce a sound one octave higher. If the highest key is set to a note higher than G8, it will produce a sound one octave lower.	This is normal.
The tempo does not change even though the Song was recorded with tempo changes.	Depending on the timing of tempo changes, the tempo change may not have been recorded. In this case, the recording will be played back at the original tempo. Make tempo changes when the recording track is selected and a red track indicator is flashing. The same method applies to editing the tempo after recording.	This is normal. Check the location of the tempo change.
Performance in Dual or Split mode is not recorded, and one or more tracks have been unexpectedly deleted.	For Dual or Split mode recording, the recording track for the Layer part Voice or the Left part Voice is automatically assigned (page 48). Therefore, if the track already has data, the data will be overwritten during recording. Also, the actual process of switching to Dual mode or Split mode in the middle of the Song is not recorded. Therefore, the notes you played with the Layer part Voice or the Left part Voice are not recorded.	This is normal.
Cannot change the time signature in the Song after recording.	The time signature cannot be changed in the middle of the measure.	Press the [STOP] button to locate the top of the Song, use the B [- (NO)][+ (YES)] buttons to locate the measure in which you wish to change the time signature, and then change it.
The Song title is not correct.	The “Character Code” setting may be different than that used when you named the Song.	Use the “Character Code” parameter (page 84) in the [SONG FILE] button to change the setting.
The Performance title is not correct.	The “Character Code” parameter setting (page 84) has been changed from the one set when naming the Performance file.	Make sure that the “Character Code” parameter is set to the same one as set when the Performance file was named.

# MIDI Data Compatibility

The data and the MIDI device must match in regards to the items below.

## Voice allocation format

With MIDI, Voices are assigned to specific numbers, called “program numbers.” The numbering standard (order of Voice allocation) is referred to as the “Voice allocation format.” Voices may not play back as expected unless the Voice allocation format of the Song data matches that of the compatible MIDI device used for playback.

### GM System Level 1

This is one of the most common Voice allocation formats. Many MIDI devices are compatible with GM System Level 1. Most commercially available music data is created as Format 0 “GM System Level 1.”

### XG

XG is a major enhancement of the GM System Level 1 format, and was developed by Yamaha specifically to provide more Voices and variations, as well as greater expressive control over Voices and effects, and to ensure compatibility of data well into the future. Song data recorded on the instrument using Voices in the XG category is XG-compatible.

# Factory Setting List

## Voice settings [VOICE EDIT]

All the Voice settings differ depending on the current Voice.

## MIDI settings [MIDI SETTING]

Parameter name	Settings	Value	Page
MidiOutChannel	Setting the MIDI transmit channel	Main: Ch 1 Left: Ch 2 Layer: Ch 3 Left Layer: Ch 4	65
MidiInChannel	Setting the MIDI receive channel	Ch 1 – 16: Song Ch 17: Keyboard Ch 18: Main Ch 19: Left Ch 20: Layer Ch 21: Left Layer Ch 22 – 32: Off	65
LocalControl	Turning local control on/off	On	65
MidiOutSelect	Selecting performance from the keyboard or Song data for MIDI transmission	Keyboard	65
ReceiveParameter	Selecting the types of data received via MIDI	All data: On	66
TransmitParameter	Selecting the types of data transmitted via MIDI	All data: On	66
InitialSetup	Transmitting the initial settings on the panel	—	66
BulkDump	Executing Voice data bulk dump	Current	66

## Other settings [OTHER SETTING]

Parameter name	Settings	Value	Page
TouchResponse	Selecting the touch response	Medium	68
Tune	Fine tuning the pitch	A3 = 440.0 Hz	68
PianoTuningCurve	Selecting a tuning curve for a Piano Voice	Stretch	68
Scale	Selecting a scale	Equal	68
SplitPoint	Specifying the Split Point (Main)	F#2	69
SplitPoint2	Specifying the Split Point 2 (Layer)	F#2	69
Transpose	Changing the key	Keyboard = 0 Song = 0	69
SoftPedalDepth	Adjusting the depth of the Soft pedal	5	69
StringResonanceDepth	Setting the depth of String Resonance	5	69
SustainSamplingDepth	Setting the depth of Sustain Sampling for the Sustain pedal	5	69
KeyOffSamplingDepth	Specifying the volume of the Key-off sound	5	70
VibraphonePedalMode	Selecting a pedal function for Vibraphone Voice	PianoLike	70
PedalPlay/Pause	Assigning the SONG [PLAY/PAUSE] function to the pedal	All pedals: Off	70
PedalType	Selecting a pedal type	Pedal 1, Pedal 2, Pedal 3: Make; Pedal 4: Break	70

## Factory Setting List

Parameter name	Settings	Value	Page
HalfPedalPoint	Setting the point at which the sustain pedal starts to affect the sound	0	70
PitchBendRange	Setting the Pitch Bend range	2	70
EqualizerLock	Locking the Master Equalizer settings	On	71
MemoryBackUp	Selecting items saved at shutdown	Transpose, Main/Left Layer, OtherSetting: Off, Others: On	71
FactorySet	Restoring the default settings	MemoryFileExcluded	71

## Master settings [MASTER EDIT]

Parameter name	Settings	Value	Page
Slider	Assigning a function to the [ZONE CONTROL] slider	VOLUME	54
SendBankMsb	Setting the MSB of the Send Bank Select message	0	54
SendBankLsb	Setting the LSB of the Send Bank Select message	0	54
SendPG#	Setting the Program Change message	1	54
Octave	Setting the octave of the external tone generator	0	55
InterITG	Turning the internal tone generator on/off	On	55
MidiOutChannel	Setting the MIDI transmit channel when the Master mode is turned on	Zone 1: Ch 1, Zone 2: Ch 2, Zone 3: Ch 3, Zone 4: Ch 4	55

## Settings for Song recording and playback [SONG SETTING]

Parameter name	Settings	Value	Page
Quantize	Correcting note timing.	Off	86
SwingRate	Determining how strongly the notes will be quantized.	50%	
QuickPlay	Specifying whether playback starts immediately along with the first voicing	On	86
ChannelListen	Auditioning the channels	Ch 1	86
ChannelClear	Deleting data from each channel	Ch 1	86
FromToRepeat	Specifying the range and playing back repeatedly	RepeatOff	87
SongRepeat	Playing back a Song/all Songs repeatedly	PresetSongs	87
TimeSignature	Setting the Click time signature	4/4	87
ClickVolume	Setting the Click volume level	100	87
ClickType	Setting the Click bell sound	BellOff	87



# Voice List

Voice group	Voice name	Stereo sampling	Touch Sense	Dynamic sampling	Key-off samples	String resonance	Voice description
GrandPiano1	Grand Piano 1	○	○	○	○	○	This sound was sampled from a full concert grand piano. Three stages of dynamics were sampled, and no effort has been spared in making the sound virtually identical to that of an acoustic piano. Even the tonal changes produced by the damper pedal and the subtle sounds of releasing a key are reproduced. The sympathetic vibration (string resonance) that occurs between the strings of an acoustic piano has also been simulated. Suitable not only for classical compositions but also for piano pieces of any style.
	Mellow Piano 1	○	○	○	○	○	A warm and mellow piano sound. Ideal for classical music.
	Rock Piano	○	○	○	○	○	A bright-sounding piano. Ideal for rock styles.
	HonkyTonk Piano	○	○	○	○	○	A honky-tonk style piano. Enjoy a tonal character that is quite different than a grand piano.
GrandPiano2	Grand Piano 2	○	○	–	–	–	A spacious and clear piano sound with a bright resonance. Ideal for popular music.
	Mellow Piano 2	○	○	–	–	–	A mellow piano sound with a different character than Mellow Piano 1.
Mono Piano	Mono Piano 1	–	○	○	–	–	The sound of a mono piano. Good for ensemble performance.
	Mono Piano 2	–	○	–	–	–	A mono piano sound with a different character than Mono Piano 1.
	Comp. Piano 1	–	○	○	–	–	A mono piano sound with compression effect.
	Comp. Piano 2	–	○	–	–	–	A mono piano sound with a different character than Comp. Piano 1.
E.Piano1	Chorus E.Piano	–	○	○	○	–	The sound of an electric piano that generates sound by striking metal tines with a hammer. Softly played notes will have a mellow character, and strongly played notes will sound more forceful. A chorus effect is applied to create warmth.
	Phaser E.Piano	–	○	○	○	–	A distinctive phaser effect makes this ideal for fusion styles.
	AutoPan E.Piano	–	○	○	○	–	An electric piano with a characteristic panning effect.
	Standard E.Piano	–	○	○	○	–	A straightforward electric piano sound with reverb as the only effect.
E.Piano2	DX E.Piano 1	○	○	○	–	–	The sound of an electronic piano as simulated by an FM synthesizer such as the DX7. Differences in playing dynamics will affect the tone. Ideal for popular songs.
	DX E.Piano 2	–	○	–	–	–	An FM synthesizer electronic piano sound using a different algorithm than DX E.Piano 1, with a bright sounding character.
	Synth Piano	–	○	–	–	–	This Voice simulates the electric piano sound produced by synthesizers in popular music. It also goes well with the acoustic piano sound.
E.Piano3	Tremolo Vintage E.P.	–	○	○	–	–	The sound of an electric piano of a different type than E.Piano 1, often used in rock and popular music.
	Vintage E.Piano	–	○	○	–	–	An electric piano sound with a vintage character, and reverb as the only effect.
	Amp.Sim. Vintage E.P.	–	○	○	–	–	The sound of an electric piano distorted by an amp simulator effect. Ideal for rock music.

## Voice List

Voice group	Voice name	Stereo sampling	Touch Sense	Dynamic sampling	Key-off samples	String resonance	Voice description
Clavi.	Phaser Clavi.	–	○	–	○	–	This is the Voice of a keyboard that produces sound by striking the strings with magnetic pickups. This funky sound is popular in contemporary soul and R&B music. Because of its unique structure, the instrument produces a peculiar sound when you release the keys.
	Clavi. 1	–	○	–	○	–	A struck-string keyboard instrument with electromagnetic pickups. A straightforward sound with only reverb applied.
	Wah Clavi.	–	○	–	○	–	Includes a distinctive wah effect.
	Clavi. 2	–	○	–	○	–	A different type of Clavi. 1 sound.
Vibraphone	Vibraphone	○	○	○	–	–	Vibraphone played with relatively soft mallets. The tone becomes more metallic the harder you play.
	Marimba	○	○	–	–	–	A marimba sound, sampled in stereo for spaciousness and realism.
	Celesta	○	○	○	–	–	The sound of a celesta—a percussion instrument in which hammers strike metallic bars to produce sound.
Organ1	Jazz Organ	–	–	–	–	–	The sound of a “tonewheel” type electric organ. Often heard in jazz and rock idioms.
	Theater Organ	–	–	–	–	–	A bright electric organ sound.
	Rock Organ	–	–	–	–	–	An aggressive electric organ sound, ideal for rock.
	Draw Organ	–	–	–	–	–	A standard electric organ sound.
Organ2	Pipe Organ Principal	○	–	–	–	–	This Voice features the combination of pipes (8'+4'+2') of a principal (brass instrument) organ. It is suitable for Baroque church music.
	Pipe Organ Tutti	○	–	–	–	–	This Voice features a full coupler of a pipe organ, famous for the sound used in Toccata and Fugue in D Minor by Bach.
	Pipe Organ Flute	○	–	–	–	–	A pipe organ sound that combines flute-type (woodwind type) stops of different pitches (8'+4'). This is a gentle sound that is ideal for accompanying hymns.
Harpsichord	Harpsichord 8	○	–	–	○	–	The sound of the instrument frequently used in baroque music. Variations in playing touch will not affect the volume, and a characteristic sound will be heard when you release the key.
	Harpsichord 8'+4	○	–	–	○	–	A harpsichord with an added upper octave. Produces a more brilliant sound.
Strings	Strings	○	○	–	–	–	Stereo-sampled, large-scale strings ensemble with realistic reverb. Try combining this Voice with piano in the Dual mode.
	Synth Strings	○	○	–	–	–	A bright and spacious strings sound. Suitable for sustained parts in the background of an ensemble.
	Slow Strings	○	○	–	–	–	The sound of a string ensemble, with a slow attack. Suitable for use in Dual mode with GRAND PIANO or E.PIANO.
Choir/Pad.	Choir	–	○	–	–	–	A big, spacious choir Voice. Perfect for creating rich harmonies in slow pieces.
	Slow Choir	–	○	–	–	–	The sound of a choir with a slow attack. Suitable for use in Dual mode with GRAND PIANO or E.PIANO.
	Scat	–	○	○	–	–	You can enjoy jazz “scatting” with this Voice. Depending on how hard and what note range you play, different sounds will be produced.
	Synth Pad 1	–	○	–	–	–	A warm, mellow, and spacious synth sound. Ideal for sustained parts in the background of an ensemble.

Voice group	Voice name	Stereo sampling	Touch Sense	Dynamic sampling	Key-off samples	String resonance	Voice description
Choir/Pad.	Synth Pad 2	–	○	–	–	–	A clear and spacious synth sound. Ideal for sustained parts in the background of an ensemble.
Guitar	Nylon Guitar	○	○	○	–	–	A warm and natural nylon-string guitar sound. Enjoy the atmosphere it adds to a quiet song.
	Steel Guitar	–	○	–	–	–	A bright steel guitar sound. Ideal for popular music.
Bass	Wood Bass	–	○	–	–	–	The sound of a finger-plucked upright bass. Frequently used in jazz and Latin music.
	Bass&Cymbal	–	○	–	–	–	The sound of a cymbal has been layered onto the bass. Effective when used for jazz walking-bass lines.
	Electric Bass	–	○	–	–	–	The sound of an electric bass. Frequently used in jazz, rock, and popular music.
	Fretless Bass	–	○	–	–	–	The sound of a fretless bass. Suitable for styles such as jazz and fusion.

## Program Change List

Voice group	Voice name	Bank MSB	Bank LSB	P.C.#
GrandPiano1	Grand Piano 1	0	122	1
	Mellow Piano 1	0	123	1
	Rock Piano	0	122	3
	HonkyTonk Piano	0	122	4
GrandPiano2	Grand Piano 2	0	112	1
	Mellow Piano 2	0	114	1
Mono Piano	Mono Piano 1	0	123	2
	Mono Piano 2	0	114	2
	Comp. Piano 1	0	124	2
	Comp. Piano 2	0	116	2
E.Piano1	Chorus E.Piano	0	122	5
	Phaser E.Piano	0	124	5
	AutoPan E.Piano	0	125	5
	Standard E.Piano	0	126	5
E.Piano2	DX E.Piano 1	0	122	6
	DX E.Piano 2	0	123	6
	Synth Piano	0	122	89
E.Piano3	Tremolo Vintage E.P.	0	123	5
	Vintage E.Piano	0	121	5
	Amp.Sim.Vintage E.P.	0	120	5
Clavi.	Phaser Clavi.	0	124	8
	Clavi. 1	0	122	8
	Wah Clavi.	0	123	8
	Clavi. 2	0	125	8
Vibraphone	Vibraphone	0	122	12
	Marimba	0	122	13
	Celesta	0	122	9

Voice group	Voice name	Bank MSB	Bank LSB	P.C.#
Organ1	Jazz Organ	0	122	17
	Theater Organ	0	124	17
	Rock Organ	0	122	19
	Draw Organ	0	125	17
Organ2	Pipe Organ Principal	0	123	20
	Pipe Organ Tutti	0	122	20
	Pipe Organ Flute	0	124	20
Harpsichord	Harpsichord 8'	0	122	7
	Harpsichord 8'+4'	0	123	7
Strings	Strings	0	122	49
	Synth Strings	0	122	51
	Slow Strings	0	122	50
Choir/Pad.	Choir	0	122	53
	Slow Choir	0	123	53
	Scat	0	122	54
	Synth Pad 1	0	122	90
Guitar	Synth Pad 2	0	122	92
	Nylon Guitar	0	122	25
Bass	Steel Guitar	0	122	26
	Wood Bass	0	122	33
	Bass&Cymbal	0	124	33
	Electric Bass	0	122	34
XG	Fretless Bass	0	122	36
	480 Voices	–	–	–

P.C.# = Program Change number (1-128)

When you specify a program change as a number in the range of 0-127, specify a number that is one less than the program number listed below. For example, to specify program number 128, you would actually enter program change 127.

For details about XG Voices, refer to the XG Voice List (page 108).

# Preset Performance List

Number	Performance name	Type	Voices used				Performance description
			Main	Layer	Left	Left Layer	
A01	Piano+Pad	Dual	GrandPiano1	WarmPad			Grand piano layered with a warm-sounding pad. Usable in a variety of situations from rapid passages to ballads.
A02	Piano+E.Piano	Dual	GrandPiano1	ChorusE.P.			Widely-used layered sound with piano and electric piano. Ideal for 80's pop.
A03	Piano+DX E.P.1	Dual	GrandPiano1	DX E.Piano1			Widely-used layered sound with piano and DX electric piano. Enjoy harmonies with the sparkling electric piano.
A04	Piano+DX E.P.2	Dual	GrandPiano2	DX E.Piano2			Another type of layered piano and DX electric piano.
A05	Piano+SoftStr	Dual	GrandPiano2	S.SlwStr			Piano layered with soft strings.
A06	HonkyTonkPiano	Dual	GrandPiano1	GrandPiano1			Honky-tonk piano that simulates slight detuning.
A07	E.Piano+Pad	Dual	AutoPanE.P.	SynthPad1			Auto-panned electric piano layered with a soft pad. Beautifully spacious stereo spread.
A08	E.Piano+DX E.P.	Dual	StandardE.P	DX E.Piano1			Layered electric piano and DX electric piano.
A09	E.Piano+SlowStr	Dual	ChorusE.P.	SlowStrings			Chorused electric piano layered with slow attack strings.
A10	E.Piano+Vintage E.P.	Dual	StandardE.P	VintageE.P.			Standard electric piano layered with vintage type electric piano.
A11	DX E.P.+SoftStr	Dual	DX E.Piano2	S.SlwStr			DX electric piano layered with soft strings.
A12	DX E.P.+SynthPiano	Dual	DX E.Piano2	SynthPiano			DX electric piano layered with synth piano.
A13	PipeOrgan+Choir	Dual	PipeOrganTu	Choir			Magnificent layered sound with pipe organ and chorus.
A14	Strings+Choir	Dual	Strings	Choir			Classical layered sound with strings and chorus.
A15	Orchestral Harp	Dual	NyInHarp	Harp			Beautiful layered sound of two harps, slightly delayed.
A16	PolySynthPad	Dual	PolySyPd	NewAgePd			Dense and rich motion pad. Key-on modifies the sound.
B01	WoodBass/GrandPiano	Split	GrandPiano1		Wood Bass		Standard wood bass split with piano. Ideal for playing jazz by yourself.
B02	WoodBass/NylonGuitar	Split	Nylon Guitar		Wood Bass		Nylon-string guitar split with wood bass.
B03	WoodBass/VibraPhone	Split	Vibraphone		Wood Bass		Standard wood bass split with vibraphone.
B04	Bass+Cym/JazzOrgan	Split	JazzOrgan		Bass & Cymbal		Play rhythm with bass and cymbal in the left hand, and solo organ in the right hand.
B05	E.Bass/PhaserE.P.	Split	Phaser E.Piano		Electric Bass		Electric piano with phaser (typical of 70's fusion), split with electric bass.
B06	Bass+Cym/Scat	Split	Scat		Bass & Cymbal		Play scat in the right hand, and bass and cymbal in the left. Scat sounds are velocity-switched.

Number	Performance name	Type	Voices used				Performance description
			Main	Layer	Left	Left Layer	
B07	Organ Upper/Lower	Dual+Split	JazzOrgan	SoloSine	Jazz Organ		Simulates a dual-manual organ. Play chords in the left hand, and solo with the right.
B08	E.Piano/GrandPiano	Split	GrandPiano1		Phaser E.Piano		Play chords in the left hand on an electric piano with phaser applied, and piano solo in the right.
B09	JazzOrg/GrandPiano	Split	GrandPiano1		Jazz Organ		Play organ backing in the left hand, and piano solo in the right.
B10	SynBass/SynBrass	Dual+Split	SynBrss1	SynBrss1	SynBass1Dark		Play synth bass in the left hand, and bright synth brass in the right.
B11	Delay E.Piano	Single	Standard E.Piano				Electric piano with delay applied to create a sense of space.
B12	Room Piano	Single	GrandPiano1				Piano that sounds as if heard at a distance in a spacious room.
B13	Old piano	Single	GrandPiano2				Simulation of a piano sound heard on an old record. Distorts slightly as you play harder.
B14	Baroque Ensemble	Dual+Split	Hc8'+4'	PipeOrganP	Strings	Choir	Play strings and chorus in the left hand, and harpsichord and pipe organ in the right.
B15	AOR Split	Dual+Split	GrandPiano2	SynthPad1	E.Bass	MuteGtr	Rich sound that lets you play muted guitar and bass in the left hand, and piano and pad in the right.
B16	Drum Kit	Drm	StandardKit1				The CP300 provides high-quality drum sounds as well as piano sounds. Try out your drumming skills!

The 32 Performances in variations C, D use the Grand Piano 1 Voice.





XG Voice List

Instrument Group	Pgm#	Bank 0 Bank Select LSB=00	Bank 0	E	Velo-Switch				Velo-Xfade		other wave										E						
					Bank 41	Bank 42	Bank 43	Bank 44	Bank 45	Bank 46	Bank 47	Bank 48	Bank 49	Bank 50	Bank 51	Bank 52	Bank 53	Bank 54	Bank 55	Bank 56							
Piano	1	Acoustic Grand Piano	GrandPno	2	Drum	2																					
	2	Bright Acoustic Piano	BritePno	2																							
	3	Electric Grand Piano	ElGrand	2	LayerCP2	2																					
	4	Honky-tonk Piano	HnklyTonk	2																							
	5	Electric Piano 1	E Piano1	2					VX El.F1	2	60sEl.F1	1															
	6	Electric Piano 2	E Piano2	2	DX+Analg	2	DXKotoEP	2	VX El.F2	2																	
	7	Harpischord	Harpsi.	1																							
	8	Clavi	Clavi	2							PulseClv	1	PierceCl	2													
Chromatic Percussion	9	Coleta	Coleta	1																							
	10	Glockenspiel	Glocken	1																							
	11	Music Box	MusicBox	2							Orgel	2															
	12	Vibraphone	Vibes	1				HardVibe	2																		
	13	Marimba	Marimba	1							SineMmb	2															
	14	Xylophone	Xylophon	1																							
	15	Tubular Bells	TubuBel	1																							
	16	Dulcimer	Dulcimer	1																							
Organ	17	Drawbar Organ 1	DrawOrgn	1							Organ 8a	1	70sDrOrg	2	CheerOrg	2	DrawOrg3	2									
	18	Percussive Organ	PercOrgn	1																							
	19	Rock Organ	RockOrgn	2																							
	20	Church Organ 1	ChrchOrg	2																							
	21	Reed Organ	ReedOrgn	1																							
	22	Accordion	Acordion	2																							
	23	Harmonica	Harmonica	1																							
	24	Tango Accordion	TangoAcCd	2							TngoAcCd2	2															
Guitar	25	Acoustic Guitar (nylon) 1	NylonGtr	1				VelGHrm	2																		
	26	Acoustic Guitar (steel)	SteelGtr	1	SH&Body	2																					
	27	Electric Guitar (jazz)	Jazz Gtr	1																							
	28	Electric Guitar (clean)	CleanGtr	1																							
	29	Electric Guitar (muted)	MutedGtr	1	MuteSIG	2			FunkGtr2	2	Jazz Man	1															
	30	Overdriven Guitar	Overdrive	1					GI Pinch	2																	
	31	Distortion Guitar	Dist.Gtr	1	FeedbKG2	2																					
	32	Guitar Harmonics	GtrHarmo	1											GIFedbk	1	GtrHmo2	1									
Bass	33	Acoustic Bass	Aco Bass	1						VXUprght	2																
	34	Electric Bass (finger)	FngrBass	1				FngrSlap	2	FngBass2	2				Mod.Bass	2											
	35	Electric Bass (pick)	PickBass	1																							
	36	Fretless Bass	Fretless	1																							
	37	Slap Bass 1	SlapBass1	1																							
	38	Slap Bass 2	SlapBass2	1																							
	39	Synth Bass 1	SynBass1	1				VeloSlap	2																		
	40	Synth Bass 2	SynBass2	2	DX Bass	2																					
Strings	41	Violin	Violin	1																							
	42	Viola	Viola	1																							
	43	Cello	Cello	1																							
	44	Contrabass	Contrabs	1																							
	45	Tremolo Strings	Trem.Str	1																							
	46	Pizzicato Strings	Pizz.Str	1																							
	47	Orchestral Harp	Harp	1																							
	48	Tringani	Tringani	1																							
Ensemble	49	String Ensemble 1	StringE1	1	Orchr2	2	TrmOrch	2		Velo.Str	2																
	50	String Ensemble 2	StringE2	1	Kingdom	2																					
	51	Synth Strings 1	Syn.Str1	2																							
	52	Synth Strings 2	Syn.Str2	2																							
	53	Choir Aahs	Choir.Aah	1																							
	54	Voice Oohs	Voice.Ooh	1																							
	55	Synth Voice	Syn.Voice	1	Choral	2									Ana.Voice	1											
	56	Orchestra Hit	Orch.Hit	2											Impact	2											
Brass	57	Trumpet	Trumpet	1																							
	58	Trombone	Trombone	1																							
	59	Tuba	Tuba	1																							
	60	Muted Trumpet	Mute.Trp	1																							
	61	French Horn	Fr.Horn	2																							
	62	Brass Section 1	BrasSect	1	Hi Brass	2	MelloBr	2																			
	63	Synth Brass 1	SynBrs1	2					AnVelBr1	2	AnaBrs1	2															
	64	Synth Brass 2	SynBrs2	1	ChoirBrs	2			AnVelBr2	2	AnaBrs2	2															
Reed	65	Soprano Sax	SprmoSax	1																							
	66	Alto Sax	Alto Sax	1					HyprAlto	2																	
	67	Tenor Sax	TenorSax	1	SoftTenr	2																					
	68	Baritone Sax	Bar.Sax	1																							
	69	Oboe	Oboe	2																							
	70	English Horn	Eng.Horn	1																							
	71	Bassoon	Bassoon	1																							
	72	Clarinet	Clarinet	1																							
Pipe	73	Piccolo	Piccolo	1																							
	74	Flute	Flute	1																							
	75	Recorder	Recorder	1																							
	76	Pan Flute	PanFlute	1																							
	77	Blown Bottle	Bottle	2																							
	78	Shakuhachi	Shakhchi	2		</																					





# XG Drum Kit List

- Key-off: Keys marked "O" stop sounding the instant they are released.
- Alternate Group: Playing any instrument within a numbered group will immediately stop the sound of any other instrument in the same group of the same number

Same as Standard Kit 1  
 No Sound

Bank Select MSB (0-127)		127	127	127	127	127	127	127		
Bank Select LSB (0-127)		0	0	0	0	0	0	0		
Program Change (1-128)		1	2	9	17	25	26	28		
MIDI Note#	Note	Key Off	Alternate Group	Standard Kit1	Standard Kit2	Room Kit	Rock Kit	Electro Kit	Analog Kit	Dance Kit
13	C#-1		3	Surdo Mute						
14	D-1		3	Surdo Open						
15	D#-1			Hi Q						
16	E-1			Whip Slap						
17	F-1		4	Scratch H						
18	F#-1		4	Scratch L						
19	G-1			Finger Snap						
20	G#-1			Click Noise						
21	A-1			Metronome Click						
22	A#-1			Metronome Bell						
23	B-1			Seq Click L						
24	C0			Seq Click H						
25	C#0			Brush Tap						
26	D0	O		Brush Swirl						
27	D#0			Brush Slap						
28	E0	O		Brush Tap Swirl				Reverse Cymbal	Reverse Cymbal	Reverse Cymbal
29	F0	O		Snare Roll						
30	F#0			Castanet				Hi Q 2	Hi Q 2	Hi Q 2
31	G0			Snare Soft	Snare Soft 2		Snare Noisy	Snare Snappy Electro	Snare Noisy 4	Snare Techno
32	G#0			Sticks						
33	A0			Kick Soft				Kick 3	Kick 3	Kick Techno Q
34	A#0			Open Rim Shot	Open Rim Shot H Short					Rim Gate
35	B0			Kick Tight			Kick 2	Kick Gate	Kick Analog Short	Kick Techno L
36	C1			Kick	Kick Short		Kick Gate	Kick Gate Heavy	Kick Analog	Kick Techno
37	C#1			Side Stick	Side Stick Light				Side Stick Analog	Side Stick Analog
38	D1			Snare	Snare Short	Snare Snappy	Snare Rock	Snare Noisy 2	Snare Analog	Snare Clap
39	D#1			Hand Clap						
40	E1			Snare Tight	Snare Tight H	Snare Tight Snappy	Snare Rock Tight	Snare Noisy 3	Snare Analog 2	Snare Dry
41	F1			Floor Tom L		Tom Room 1	Tom Rock 1	Tom Electro 1	Tom Analog 1	Tom Analog 1
42	F#1		1	Hi-Hat Closed					Hi-Hat Closed Analog	Hi-Hat Closed 3
43	G1			Floor Tom H		Tom Room 2	Tom Rock 2	Tom Electro 2	Tom Analog 2	Tom Analog 2
44	G#1		1	Hi-Hat Pedal					Hi-Hat Closed Analog 2	Hi-Hat Closed Analog 3
45	A1			Low Tom		Tom Room 3	Tom Rock 3	Tom Electro 3	Tom Analog 3	Tom Analog 3
46	A#1		1	Hi-Hat Open					Hi-Hat Open Analog	Hi-Hat Open 3
47	B1			Mid Tom L		Tom Room 4	Tom Rock 4	Tom Electro 4	Tom Analog 4	Tom Analog 4
48	C2			Mid Tom H		Tom Room 5	Tom Rock 5	Tom Electro 5	Tom Analog 5	Tom Analog 5
49	C#2			Crash Cymbal 1					Crash Analog	Crash Analog
50	D2			High Tom		Tom Room 6	Tom Rock 6	Tom Electro 6	Tom Analog 6	Tom Analog 6
51	D#2			Ride Cymbal 1						
52	E2			Chinese Cymbal						
53	F2			Ride Cymbal Cup						
54	F#2			Tambourine						
55	G2			Splash Cymbal						
56	G#2			Cowbell					Cowbell Analog	Cowbell Analog
57	A2			Crash Cymbal 2						
58	A#2			Vibraslap						
59	B2			Ride Cymbal 2						
60	C3			Bongo H						
61	C#3			Bongo L						
62	D3			Conga H Mute					Conga Analog H	Conga Analog H
63	D#3			Conga H Open					Conga Analog M	Conga Analog M
64	E3			Conga L					Conga Analog L	Conga Analog L
65	F3			Timbale H						
66	F#3			Timbale L						
67	G3			Agogo H						
68	G#3			Agogo L						
69	A3			Cabasa						
70	A#3			Maracas					Maracas 2	Maracas 2
71	B3	O		Samba Whistle H						
72	C4	O		Samba Whistle L						
73	C#4			Guiro Short						
74	D4	O		Guiro Long						
75	D#4			Claves					Claves 2	Claves 2
76	E4			Wood Block H						
77	F4			Wood Block L						
78	F#4			Cuica Mute				Scratch H 2	Scratch H 2	Scratch H 2
79	G4			Cuica Open				Scratch L 2	Scratch L 2	Scratch L 2
80	G#4		2	Triangle Mute						
81	A4		2	Triangle Open						
82	A#4			Shaker						
83	B4			Jingle Bells						
84	C5			Bell Tree						
85	C#5									
86	D5									
87	D#5									
88	E5									
89	F5									
90	F#5									
91	G5									

Bank Select MSB (0-127)			127	127	127	126	126
Bank Select LSB (0-127)			0	0	0	0	0
Program Change (1-128)			33	41	49	1	2
MIDI	Key	Alternate	Jazz Kit	Brush Kit	Symphony Kit	SFX Kit1	SFX Kit2
Note#	Note	Off					
13	C#-1						
14	D-1	3					
15	D#-1						
16	E-1						
17	F-1	4					
18	F#-1	4					
19	G-1						
20	G#-1						
21	A-1						
22	A#-1						
23	B-1						
24	C0						
25	C#0						
26	D0	O					
27	D#0						
28	E0	O					
29	F0	O					
30	F#0						
31	G0		Snare Jazz H	Brush Slap 2			
32	G#0						
33	A0				Kick Soft 2		
34	A#0			Open Rim Shot Light			
35	B0				Gran Cassa		
36	C1		Kick Jazz	Kick Jazz	Gran Cassa Mute	Cutting Noise	Phone Call
37	C#1		Side Stick Light	Side Stick Light		Cutting Noise 2	Door Squeak
38	D1		Snare Jazz L	Brush Slap 3	Band Snare		Door Slam
39	D#1					String Slap	Scratch Cut
40	E1		Snare Jazz M	Brush Tap 2	Band Snare 2		Scratch H 3
41	F1			Tom Brush 1			Wind Chime
42	F#1	1					Telephone Ring 2
43	G1			Tom Brush 2			
44	G#1	1					
45	A1			Tom Brush 3			
46	A#1	1					
47	B1			Tom Brush 4			
48	C2			Tom Brush 5			
49	C#2				Hand Cymbal		
50	D2			Tom Brush 6			
51	D#2				Hand Cymbal Short		
52	E2					Flute Key Click	Car Engine Ignition
53	F2						Car Tires Squeal
54	F#2						Car Passing
55	G2						Car Crash
56	G#2						Siren
57	A2				Hand Cymbal 2		Train
58	A#2						Jet Plane
59	B2				Hand Cymbal 2 Short		Starship
60	C3						Burst
61	C#3						Roller Coaster
62	D3						Submarine
63	D#3						
64	E3						
65	F3						
66	F#3						
67	G3						
68	G#3					Shower	Laugh
69	A3					Thunder	Scream
70	A#3					Wind	Punch
71	B3	O				Stream	Heart Beat
72	C4	O				Bubble	Foot Steps
73	C#4					Feed	
74	D4	O					
75	D#4						
76	E4						
77	F4						
78	F#4						
79	G4						
80	G#4	2					
81	A4	2					
82	A#4						
83	B4						
84	C5					Dog	Machine Gun
85	C#5					Horse	Laser Gun
86	D5					Bird Tweet 2	Explosion
87	D#5						Firework
88	E5						
89	F5						
90	F#5					Ghost	
91	G5					Maou	

# Effect Type List

## ■ Reverb

Reverb types that can be selected by panel operation

Type MSB	Type LSB	Effect Name	Display
2	17	Room 4	Room
1	19	Hall 4	Hall 1
1	17	Hall 3	Hall 2
3	17	Stage 3	Stage
4	16	Plate 2	Plate

All reverb types

Type MSB	Type LSB	Effect Name
0	0	No Effect
1	0	Hall 1
1	1	Hall 2
1	6	Hall M
1	7	Hall L
1	17	Hall 3
1	19	Hall 4
2	0	Room 1
2	1	Room 2
2	2	Room 3
2	5	Room S
2	6	Room M
2	7	Room L
2	17	Room 4
3	0	Stage 1
3	1	Stage 2
3	17	Stage 3
3	18	Sound Board
4	0	Plate 1
4	7	GM Plate
4	16	Plate 2
16	0	White Room
17	0	Tunnel
18	0	Canyon
19	0	Basement

## ■ Chorus

Chorus types that can be selected by panel operation

Type MSB	Type LSB	Effect Name	Display
65	8	Chorus 4	Chorus
66	8	Celeste 4	Celeste
67	1	Flanger 2	Flanger

All chorus types

Type MSB	Type LSB	Effect Name
0	0	No Effect
65	0	Chorus 1
65	1	Chorus 2
65	2	Chorus 3
65	3	GM Chorus 1
65	4	GM Chorus 2
65	5	GM Chorus 3
65	6	GM Chorus 4
65	7	FB Chorus
65	8	Chorus 4
66	0	Celeste 1
66	1	Celeste 2
66	2	Celeste 3
66	8	Celeste 4
66	18	Rotary Speaker 1
67	0	Flanger 1
67	1	Flanger 2
67	7	GM Flanger
67	8	Flanger 3
68	0	Symphonic 1
68	16	Symphonic 2
72	0	Phaser 1
72	8	Phaser 2
72	20	Phaser 3
87	0	Ens Detune

## ■ Variation/Insertion

Variation/insertion types that can be selected by panel operation

Type MSB	Type LSB	Effect Name	Display
5	16	Delay L,C,R 2	Delay L,C,R
6	0	Delay L,R	Delay L,R
7	0	Echo	Echo
8	0	Cross Delay	Cross Delay
68	16	Symphonic 2	Symphonic
66	18	RotarySpeaker1	Rotary Speaker
70	22	Tremolo 3	Tremolo
119	0	VibeRotor	VibeRotor
71	27	Auto Pan 3	Auto Pan
72	20	Phaser 3	Phaser
78	21	Auto Wah 2	Auto Wah
3	18	Sound Board	Sound Board
75	26	AmpSimulator2	Amp Simulator
83	16	Compressor 2	Compressor

All variation/insertion effects

Type MSB	Type LSB	Effect Name
0	0	No Effect
1	0	Hall 1
1	1	Hall 2
1	6	Hall M
1	7	Hall L
2	0	Room 1
2	1	Room 2
2	2	Room 3
2	5	Room S
2	6	Room M
2	7	Room L
3	0	Stage 1
3	1	Stage 2
3	18	Sound Board
4	0	Plate
4	7	GM Plate
5	0	Delay L,C,R 1
5	16	Delay L,C,R 2
6	0	Delay L,R
7	0	Echo
8	0	Cross Delay
9	0	ER1
9	1	ER2
10	0	Gate Reverb
11	0	Reverse Gate
16	0	White Room
17	0	Tunnel
18	0	Canyon
19	0	Basement
20	0	Karaoke 1
20	1	Karaoke 2
20	2	Karaoke 3
21	0	Tempo Delay
21	8	Tempo Echo
22	0	Tempo Cross
64	0	Thru
65	0	Chorus1
65	1	Chorus2
65	2	Chorus3
65	3	GM Chorus 1
65	4	GM Chorus 2
65	5	GM Chorus 3
65	6	GM Chorus 4
65	7	FB Chorus
65	8	Chorus 4
66	0	Celeste 1
66	1	Celeste 2
66	2	Celeste 3
66	8	Celeste 4
66	18	Rotary Speaker 1
67	0	Flanger 1
67	1	Flanger 2
67	7	GM Flanger
67	8	Flanger 3
68	0	Symphonic 1
68	16	Symphonic 2
72	0	Phaser 1
72	8	Phaser 2
72	20	Phaser 3
67	7	GM Flanger
67	8	Flanger 3

Type MSB	Type LSB	Effect Name
68	0	Symphonic 1
68	16	Symphonic 2
69	0	Rotary Speaker 2
69	1	Dist + Rot Sp
69	2	OD + Rot Sp
69	3	Amp Sin + Rot Sp
70	0	Tremolo 1
70	19	Tremolo 2
70	22	Tremolo 3
71	0	AutoPan 1
71	26	AutoPan 2
71	27	AutoPan 3
72	0	Phaser 1
72	8	Phaser 2
72	20	Phaser 3
73	0	Distortion
73	1	Comp Dist
73	8	Stereo Dist
74	0	Over Drive
74	8	Stereo OD
75	0	Amp Simulator 1
75	8	Stereo Amp Sim
75	26	Amp Simulator 2
76	0	3 Band EQ
77	0	2 Band EQ
78	0	Auto Wah 1
78	1	Auto Wah + Dist
78	2	Auto Wah + OD
78	21	Auto Wah 2
80	0	Pitch Change 1
80	1	Pitch Change 2
81	0	Hrm ENH
82	0	Touch Wah 1
82	1	Touch Wah + Dist
82	2	Touch Wah + OD
82	8	Touch Wah 2
83	0	Compressor 1
83	16	Compressor 2
84	0	Noise Gate
85	0	Voice Cancel
86	0	2 Way Rot Sp
86	1	Dist + 2 Rot Sp
86	2	OD + 2 Rot Sp
86	3	Amp Sim + 2 Rot Sp
87	0	Ens Detune
88	0	Ambience
93	0	Talk Mod
94	0	Lo-Fi
95	0	Dist + Delay
95	1	OD + Delay
96	0	Cmp + Dist + Dly
96	1	Cmp + OD + Dly
97	0	Wah + Dist + Dly
97	1	Wah + OD + Dly
98	0	V Dist Hard
98	1	V Dist H + Dly
98	2	V Dist Soft
98	3	V Dist S + Dly
99	0	Dual Rot Sp 1
99	1	Dual Rot Sp 2
100	0	Dist + Tmp Delay
100	1	OD + Tmp Delay
101	0	Cmp + Dist + TDly
101	1	Cmp + OD + TDly
102	0	Wah + Dist + TDly
102	1	Wah + OD + TDly
103	0	V Dist H + TDly
103	1	V Dist S + TDly
119	0	Vibe Rotor

# Effect Parameter List

Items with a dot indicator (●) in the Control column are parameters that can be controlled via assignable controllers. Note that this is applicable to the Variation effects (while Insertion is selected) and to the Insertion effects.

**HALL 1, HALL 2, HALL M, HALL L**  
**ROOM 1, ROOM 2, ROOM 3, ROOM S, ROOM M, ROOM L**  
**STAGE 1, STAGE 2**  
**PLATE (Reverb, Variation, Insertion block)**

No.	Parameter	Display	Value	See Table	Control
1	Reverb Time	0.3 – 30.0s	0 – 69	table #4	
2	Diffusion	0 – 10	0 – 10		
3	Initial Delay	0.1mS – 200.0mS (Rev) 0.1mS – 99.3mS (Var/Ins)	0 – 127 0 – 63	table #5	
4	HPF Cutoff	Thru – 8.0kHz	0 – 52	table #3	
5	LPF Cutoff	1.0k – Thru	34 – 60	table #3	
6					
7					
8					
9					
10	Dry/Wet	D63>W – D=W – D<W63	1 – 127	(table #15)	●
11	Rev Delay	0.1mS – 200.0mS (Rev) 0.1mS – 99.3mS (Var/Ins)	0 – 127 0 – 63	table #5	
12	Density	0 – 4	0 – 4		
13	Er/Rev Balance	E63>R – E=R – E<R63	1 – 127		
14	High Damp	0.1 – 1.0	1 – 10		
15	Feedback Level	-63 – +63	1 – 127	(table #16)	
16					

**HALL 3**  
**HALL 4**  
**ROOM 4**  
**STAGE 3**  
**PLATE 2 (Reverb)**

No.	Parameter	Display	Value	See Table	Control
1	Reverb Time	0.3 – 30.0s	0 – 69	table #4	
2	Diffusion	0 – 10	0 – 10		
3	Initial Delay	0.1mS – 99.3mS	0 – 63	table #5	
4	HPF Cutoff	Thru – 8.0kHz	0 – 52	table #3	
5	LPF Cutoff	1.0k – Thru	34 – 60	table #3	
6					
7					
8					
9					
10	Dry/Wet	D63>W – D=W – D<W63	1 – 127	(table #15)	●
11					
12					
13					
14	High Damp	0.1 – 1.0	1 – 10		
15					
16					

**DELAY L, C, R 1**  
**DELAY L, C, R 2 (Variation, Insertion block)**

No.	Parameter	Display	Value	See Table	Control
1	Lch Delay	0.1 – 1638.3ms	1 – 16383		
2	Rch Delay	0.1 – 1638.3ms	1 – 16383		
3	Cch Delay	0.1 – 1638.3ms	1 – 16383		
4	Feedback Delay	0.1 – 1638.3ms	1 – 16383		
5	Feedback Level	-63 – +63	1 – 127		
6	Cch Level	0 – 127	0 – 127		
7	High Damp	0.1 – 1.0	1 – 10		
8					
9					
10	Dry/Wet	D63>W – D=W – D<W63	1 – 127		●
11					
12					
13	EQ Low Frequency	32Hz – 2.0kHz	4 – 40	table #3	
14	EQ Low Gain	-12 – +12dB	52 – 76		
15	EQ High Frequency	500Hz – 16.0kHz	28 – 58	table #3	
16	EQ High Gain	-12 – +12dB	52 – 76		

**DELAY L, R (Variation, Insertion block)**

No.	Parameter	Display	Value	See Table	Control
1	Lch Delay	0.1 – 1638.3ms	1 – 16383		
2	Rch Delay	0.1 – 1638.3ms	1 – 16383		
3	Feedback Delay 1	0.1 – 1638.3ms	1 – 16383		
4	Feedback Delay 2	0.1 – 1638.3ms	1 – 16383		
5	Feedback Level	-63 – +63	1 – 127		
6	High Damp	0.1 – 1.0	1 – 10		
7					
8					
9					
10	Dry/Wet	D63>W – D=W – D<W63	1 – 127		●
11					
12					
13	EQ Low Frequency	32Hz – 2.0kHz	4 – 40	table #3	
14	EQ Low Gain	-12 – +12dB	52 – 76		
15	EQ High Frequency	500Hz – 16.0kHz	28 – 58	table #3	
16	EQ High Gain	-12 – +12dB	52 – 76		

**ECHO (Variation, Insertion block)**

No.	Parameter	Display	Value	See Table	Control
1	Lch Delay1	0.1 – 1486.0ms	1 – 14860		
2	Lch Feedback Level	-63 – +63	1 – 127		
3	Rch Delay1	0.1 – 1486.0ms	1 – 14860		
4	Rch Feedback Level	-63 – +63	1 – 127		
5	High Damp	0.1 – 1.0	1 – 10		
6	Lch Delay2	0.1 – 1486.0ms	1 – 14860		
7	Rch Delay2	0.1 – 1486.0ms	1 – 14860		
8	Delay2 Level	0 – 127	0 – 127		
9					
10	Dry/Wet	D63>W – D=W – D<W63	1 – 127		●
11					
12					
13	EQ Low Frequency	32Hz – 2.0kHz	4 – 40	table #3	
14	EQ Low Gain	-12 – +12dB	52 – 76		
15	EQ High Frequency	500Hz – 16.0kHz	28 – 58	table #3	
16	EQ High Gain	-12 – +12dB	52 – 76		

**CROSS DELAY (Variation, Insertion block)**

No.	Parameter	Display	Value	See Table	Control
1	L->R Delay	0.1 – 1486.0ms	1 – 14860		
2	R->L Delay	0.1 – 1486.0ms	1 – 14860		
3	Feedback Level	-63 – +63	1 – 127		
4	Input Select	L, R, L&R	0 – 2		
5	High Damp	0.1 – 1.0	1 – 10		
6					
7					
8					
9					
10	Dry/Wet	D63>W – D=W – D<W63	1 – 127		●
11					
12					
13	EQ Low Frequency	32Hz – 2.0kHz	4 – 40	table #3	
14	EQ Low Gain	-12 – +12dB	52 – 76		
15	EQ High Frequency	500Hz – 16.0kHz	28 – 58	table #3	
16	EQ High Gain	-12 – +12dB	52 – 76		

**EARLY REF 1, EARLY REF 2 (Variation, Insertion block)**

No.	Parameter	Display	Value	See Table	Control
1	Type	S-H, L-H, Rdm, Rvs, Plt, Spr	0 – 5		
2	Room Size	0.1 – 7.0	0 – 44	table #6	
3	Diffusion	0 – 10	0 – 10		
4	Initial Delay	0.1ms – 200.0ms	0 – 127	table #5	
5	Feedback Level	-63 – +63	1 – 127		
6	HPF Cutoff	Thru – 8.0kHz	0 – 52	table #3	
7	LPF Cutoff	1.0k – Thru	34 – 60	table #3	
8					
9					
10	Dry/Wet	D63>W – D=W – D<W63	1 – 127		●
11	Liveness	0 – 10	0 – 10		
12	Density	0 – 3	0 – 3		
13	High Damp	0.1 – 1.0	1 – 10		
14					
15					
16					

**Effect Parameter List**

**GATE REVERB**

**REVERSE GATE (Variation, Insertion block)**

No.	Parameter	Display	Value	See Table	Control
1	Type	Type A, Type B	0 – 1		
2	Room Size	0.1 – 7.0	0 – 44	table #6	
3	Diffusion	0 – 10	0 – 10		
4	Initial Delay	0.1ms – 200.0ms	0 – 127	table #5	
5	Feedback Level	-63 – +63	1 – 127		
6	HPF Cutoff	Thru – 8.0kHz	0 – 52	table #3	
7	LPF Cutoff	1.0k – Thru	34 – 60	table #3	
8					
9					
10	Dry/Wet	D63>W – D=W – D<W63	1 – 127		●
11	Liveness	0 – 10	0 – 10		
12	Density	0 – 3	0 – 3		
13	High Damp	0.1 – 1.0	1 – 10		
14					
15					
16					

**WHITE ROOM**

**TUNNEL**

**CANYON**

**BASEMENT (Reverb, Variation, Insertion block)**

No.	Parameter	Display	Value	See Table	Control
1	Reverb Time	0.3 – 30.0s	0 – 69	table #4	
2	Diffusion	0 – 10	0 – 10		
3	Initial Delay	0.1ms – 99.3ms	0 – 63	table #5	
4	HPF Cutoff	Thru – 8.0kHz	0 – 52	table #3	
5	LPF Cutoff	1.0k – Thru	34 – 60	table #3	
6	Width	0.5 – 10.2m	0 – 37	table #11	
7	Height	0.5 – 20.2m	0 – 73	table #11	
8	Depth	0.5 – 30.2m	0 – 104	table #11	
9	Wall Vary	0 – 30	0 – 30		
10	Dry/Wet	D63>W – D=W – D<W63	1 – 127		●
11	Rev Delay	0.1ms – 99.3ms	0 – 63	table #5	
12	Density	0 – 4	0 – 4		
13	Er/Rev Balance	E63>R – E=R – E<R63	1 – 127		
14	High Damp	0.1 – 1.0	1 – 10		
15	Feedback Level	-63 – +63	1 – 127		
16					

**KARAOKE 1, 2, 3 (Variation, Insertion block)**

No.	Parameter	Display	Value	See Table	Control
1	Delay Time	0.1ms – 400.0ms	0 – 127	table #7	
2	Feedback Level	-63 – +63	1 – 127		
3	HPF Cutoff	Thru – 8.0kHz	0 – 52	table #3	
4	LPF Cutoff	1.0k – Thru	34 – 60	table #3	
5					
6					
7					
8					
9					
10	Dry/Wet	D63>W – D=W – D<W63	1 – 127		●
11	Density	0 – 3	0 – 3		
12					
13					
14					
15					
16					

**TEMPO DELAY**

**TEMPO ECHO (Variation, Insertion block)**

No.	Parameter	Display	Value	See Table	Control
1	Delay Time	64th/3 – 4thx6	0 – 19	table #14	
2	Feedback Level	-63 – +63	1 – 127		
3	Feedback High Dump	0 – 1.0	0 – 10		
4	L/R Diffusion	1 (-63ms) – 64 (0ms) – 127 (63ms)	1 – 127		
5	Lag	1 (-63ms) – 64 (0ms) – 127 (63ms)	1 – 127		
6					
7					
8					
9					
10	Dry/Wet	D63>W – D=W – D<W63	1 – 127		●
11					
12					
13	EQ Low Frequency	32Hz – 2.0kHz	4 – 40		
14	EQ Low Gain	-12 – +12dB	52 – 76		
15	EQ High Frequency	500Hz – 16.0kHz	28 – 58		
16	EQ High Gain	-12 – +12dB	52 – 76		

**TEMPO CROSS (Variation, Insertion block)**

No.	Parameter	Display	Value	See Table	Control
1	Delay Time L>R	64th/3 – 4thx6	0 – 19	table #14	
2	Delay Time R>L	64th/3 – 4thx6	0 – 19	table #14	
3	Feedback Level	-63 – +63	1 – 127		
4	Input Select	L, R, L&R	0 – 2		
5	Feedback High Dump	0 – 1.0	0 – 10		
6	Lag	1 (-63ms) – 64 (0ms) – 127 (63ms)	1 – 127		
7					
8					
9					
10	Dry/Wet	D63>W – D=W – D<W63	1 – 127		●
11					
12					
13	EQ Low Frequency	32Hz – 2.0kHz	4 – 40		
14	EQ Low Gain	-12 – +12dB	52 – 76		
15	EQ High Frequency	500 – 16.0kHz	28 – 58		
16	EQ High Gain	-12 – +12dB	52 – 76		

**CHORUS 1, 2, 3, 4**

**CELESTE 1, 2, 3, 4**

**GM CHORUS 1, 2, 3, 4**

**FB CHORUS**

**ROTARY SPEAKER 1 (Chorus, Variation, Insertion block)**

No.	Parameter	Display	Value	See Table	Control
1	LFO Frequency	0.00Hz – 39.7Hz	0 – 127	table #1	
2	LFO Depth	0 – 127	0 – 127		
3	Feedback Level	-63 – +63	1 – 127		
4	Delay Offset	0.0ms – 50ms	0 – 127	table #2	
5					
6	EQ Low Frequency	32Hz – 2.0kHz	4 – 40	table #3	
7	EQ Low Gain	-12 – +12dB	52 – 76		
8	EQ High Frequency	500Hz – 16.0kHz	28 – 58	table #3	
9	EQ High Gain	-12 – +12dB	52 – 76		
10	Dry/Wet	D63>W – D=W – D<W63	1 – 127		●
11	EQ Mid Frequency (variation block)	100Hz – 10.0kHz	14 – 54	table #3	
12	EQ Mid Gain (variation block)	-12 – +12dB	52 – 76		
13	EQ Mid Width (variation block)	1.0 – 12.0	10 – 120		
14					
15	Input Mode	mono/stereo	0 – 1		
16					

**FLANGER 1, 2, 3**

**GM FLANGER (Chorus, Variation, Insertion block)**

No.	Parameter	Display	Value	See Table	Control
1	LFO Frequency	0.00Hz – 39.7Hz	0 – 127	table #1	
2	LFO Depth	0 – 127	0 – 127		
3	Feedback Level	-63 – +63	1 – 127		
4	Delay Offset	0.0ms – 50ms	0 – 127	table #2	
5					
6	EQ Low Frequency	32Hz – 2.0kHz	4 – 40	table #3	
7	EQ Low Gain	-12 – +12dB	52 – 76		
8	EQ High Frequency	500Hz – 16.0kHz	28 – 58	table #3	
9	EQ High Gain	-12 – +12dB	52 – 76		
10	Dry/Wet	D63>W – D=W – D<W63	1 – 127		●
11	EQ Mid Frequency (variation block)	100Hz – 10.0kHz	14 – 54	table #3	
12	EQ Mid Gain (variation block)	-12 – +12dB	52 – 76		
13	EQ Mid Width (variation block)	1.0 – 12.0	10 – 120		
14	LFO Phase Difference	-180 – +180deg (resolution=3deg.)	4 – 124		
15					
16					

**SYMPHONIC 1, 2 (Chorus, Variation, Insertion block)**

No.	Parameter	Display	Value	See Table	Control
1	LFO Frequency	0.00Hz – 39.7Hz	0 – 127	table #1	
2	LFO Depth	0 – 127	0 – 127		
3	Delay Offset	0.0ms – 50ms	0 – 127	table #2	
4					
5					
6	EQ Low Frequency	32Hz – 2.0kHz	4 – 40	table #3	
7	EQ Low Gain	-12 – +12dB	52 – 76		
8	EQ High Frequency	500Hz – 16.0kHz	28 – 58	table #3	
9	EQ High Gain	-12 – +12dB	52 – 76		
10	Dry/Wet	D63>W – D=W – D<W63	1 – 127		●
11	EQ Mid Frequency (variation block)	100Hz – 10.0kHz	14 – 54	table #3	
12	EQ Mid Gain (variation block)	-12 – +12dB	52 – 76		
13	EQ Mid Width (variation block)	1.0 – 12.0	10 – 120		
14					
15					
16					

**ROTARY SPEAKER 2 (Variation, Insertion block)**

No.	Parameter	Display	Value	See Table	Control
1	LFO Frequency	0.00Hz – 39.7Hz	0 – 127	table #1	●
2	LFO Depth	0 – 127	0 – 127		
3					
4					
5					
6	EQ Low Frequency	32Hz – 2.0kHz	4 – 40	table #3	
7	EQ Low Gain	-12 – +12dB	52 – 76		
8	EQ High Frequency	500Hz – 16.0kHz	28 – 58	table #3	
9	EQ High Gain	-12 – +12dB	52 – 76		
10	Dry/Wet	D63>W – D=W – D<W63	1 – 127		
11	EQ Mid Frequency (variation block)	100Hz – 10.0kHz	14 – 54	table #3	
12	EQ Mid Gain (variation block)	-12 – +12dB	52 – 76		
13	EQ Mid Width (variation block)	1.0 – 12.0	10 – 120		
14					
15					
16					

**DISTORTION+ROTARY SPEAKER OVERDRIVE+ROTARY SPEAKER (Variation, Insertion block)**

No.	Parameter	Display	Value	See Table	Control
1	LFO Frequency	0.00Hz – 39.7Hz	0 – 127		●
2	LFO Depth	0 – 127	0 – 127		
3					
4					
5					
6	EQ Low Frequency	32Hz – 2.0kHz	4 – 40		
7	EQ Low Gain	-12 – +12dB	52 – 76		
8	EQ High Frequency	500 – 16.0kHz	28 – 58		
9	EQ High Gain	-12 – +12dB	52 – 76		
10	Dry/Wet	D63>W – D=W – D<W63	1 – 127		
11					
12					
13					
14	Drive	0 – 127	0 – 127		
15	LPF Cutoff	1kHz – Thru	34 – 60		
16	Output Level	0 – 127	0 – 127		

**AMP SIM.+ROTARY SPEAKER (Variation, Insertion block)**

No.	Parameter	Display	Value	See Table	Control
1	LFO Frequency	0.00Hz – 39.7Hz	0 – 127		●
2	LFO Depth	0 – 127	0 – 127		
3	AMP Type	Off, Stack, Combo, Tube	0 – 3		
4					
5					
6	EQ Low Frequency	32Hz – 2.0kHz	4 – 40		
7	EQ Low Gain	-12 – +12dB	52 – 76		
8	EQ High Frequency	500Hz – 16.0kHz	28 – 58		
9	EQ High Gain	-12 – +12dB	52 – 76		
10	Dry/Wet	D63>W – D=W – D<W63	1 – 127		
11					
12					
13					
14	Drive	0 – 127	0 – 127		
15	LPF Cutoff	1kHz – Thru	34 – 60		
16	Output Level	0 – 127	0 – 127		

**TREMOLO 1, 2, 3 (Variation, Insertion block)**

No.	Parameter	Display	Value	See Table	Control
1	LFO Frequency	0.00Hz – 39.7Hz	0 – 127	table #1	●
2	AM Depth	0 – 127	0 – 127		
3	PM Depth	0 – 127	0 – 127		
4					
5					
6	EQ Low Frequency	32Hz – 2.0kHz	4 – 40	table #3	
7	EQ Low Gain	-12 – +12dB	52 – 76		
8	EQ High Frequency	500Hz – 16.0kHz	28 – 58	table #3	
9	EQ High Gain	-12 – +12dB	52 – 76		
10					
11	EQ Mid Frequency (variation block)	100Hz – 10.0kHz	14 – 54	table #3	
12	EQ Mid Gain (variation block)	-12 – +12dB	52 – 76		
13	EQ Mid Width (variation block)	1.0 – 12.0	10 – 120		
14	LFO Phase Difference (resolution=3deg.)	-180 – +180deg	4 – 124		
15	Input Mode	mono/stereo	0 – 1		
16					

**AUTO PAN 1, 2, 3 (Variation, Insertion block)**

No.	Parameter	Display	Value	See Table	Control
1	LFO Frequency	0.00Hz – 39.7Hz	0 – 127	table #1	●
2	L/R Depth	0 – 127	0 – 127		
3	F/R Depth	0 – 127	0 – 127		
4	PAN Direction	L <-> R, L -> R, L <- R, Lturn, Rturn, L/R	0 – 5		
5					
6	EQ Low Frequency	32Hz – 2.0kHz	4 – 40	table #3	
7	EQ Low Gain	-12 – +12dB	52 – 76		
8	EQ High Frequency	500Hz – 16.0kHz	28 – 58	table #3	
9	EQ High Gain	-12 – +12dB	52 – 76		
10					
11	EQ Mid Frequency (variation block)	100Hz – 10.0kHz	14 – 54	table #3	
12	EQ Mid Gain (variation block)	-12 – +12dB	52 – 76		
13	EQ Mid Width (variation block)	1.0 – 12.0	10 – 120		
14					
15					
16					

**PHASER 1, 3 (Chorus, Variation, Insertion block)**

No.	Parameter	Display	Value	See Table	Control
1	LFO Frequency	0.00Hz – 39.7Hz	0 – 127	table #1	
2	LFO Depth	0 – 127	0 – 127		
3	Phase Shift Offset	0 – 127	0 – 127		
4	Feedback Level	-63 – +63	1 – 127		
5					
6	EQ Low Frequency	32Hz – 2.0kHz	4 – 40	table #3	
7	EQ Low Gain	-12 – +12dB	52 – 76		
8	EQ High Frequency	500Hz – 16.0kHz	28 – 58	table #3	
9	EQ High Gain	-12 – +12dB	52 – 76		
10	Dry/Wet	D63>W – D=W – D<W63	1 – 127		●
11	Stage	4 – 22 (chorus, variation block) 4 – 12 (insertion block)	4 – 22		
12	Diffusion	mono/stereo	0 – 1		
13					
14					
15					
16					

**PHASER 2 (Chorus, Variation, Insertion block)**

No.	Parameter	Display	Value	See Table	Control
1	LFO Frequency	0.00Hz – 39.7Hz	0 – 127	table #1	
2	LFO Depth	0 – 127	0 – 127		
3	Phase Shift Offset	0 – 127	0 – 127		
4	Feedback Level	-63 – +63	1 – 127		
5					
6	EQ Low Frequency	32Hz – 2.0kHz	4 – 40	table #3	
7	EQ Low Gain	-12 – +12dB	52 – 76		
8	EQ High Frequency	500Hz – 16.0kHz	28 – 58	table #3	
9	EQ High Gain	-12 – +12dB	52 – 76		
10	Dry/Wet	D63>W – D=W – D<W63	1 – 127		●
11	Stage	3 – 11	3 – 6		
12					
13	LFO Phase Difference (resolution=3deg.)	-180deg – +180deg	4 – 124		
14					
15					
16					

## Effect Parameter List

### DISTORTION

#### OVERDRIVE (Variation, Insertion block)

No.	Parameter	Display	Value	See Table	Control
1	Drive	0 – 127	0 – 127		●
2	EQ Low Frequency	32Hz – 2.0kHz	4 – 40	table #3	
3	EQ Low Gain	-12 – +12dB	52 – 76		
4	LPF Cutoff	1.0k – Thru	34 – 60	table #3	
5	Output Level	0 – 127	0 – 127		
6					
7	EQ Mid Frequency	100Hz – 10.0kHz	14 – 54	table #3	
8	EQ Mid Gain	-12 – +12dB	52 – 76		
9	EQ Mid Width	1.0 – 12.0	10 – 120		
10	Dry/Wet	D63>W – D=W – D<W63	1 – 127		
11	Edge (Clip Curve)	0 – 127	0 – 127	mild – sharp	
12					
13					
14					
15					
16					

#### COMP+DIST (Variation, Insertion block)

No.	Parameter	Display	Value	See Table	Control
1	Drive	0 – 127	0 – 127		●
2	EQ Low Frequency	32Hz – 2.0kHz	4 – 40	table #3	
3	EQ Low Gain	-12 – +12dB	52 – 76		
4	LPF Cutoff	1.0k – Thru	34 – 60	table #3	
5	Output Level	0 – 127	0 – 127		
6					
7	EQ Mid Frequency	100Hz – 10.0kHz	14 – 54	table #3	
8	EQ Mid Gain	-12 – +12dB	52 – 76		
9	EQ Mid Width	1.0 – 12.0	10 – 120		
10	Dry/Wet	D63>W – D=W – D<W63	1 – 127		
11	Edge (Clip Curve)	0 – 127	0 – 127	mild – sharp	
12	Attack	1ms – 40ms	0 – 19	table #8	
13	Release	10ms – 680ms	0 – 15	table #9	
14	Threshold	-48dB – -6dB	79 – 121		
15	Ratio	1.0 – 20.0	0 – 7	table #10	
16					

### STEREO DISTORTION

#### STEREO OVER DRIVE (Variation, Insertion block)

No.	Parameter	Display	Value	See Table	Control
1	Drive	0 – 127	0 – 127		●
2	EQ Low Frequency	32Hz – 2.0kHz	4 – 40	table #3	
3	EQ Low Gain	-12 – +12dB	52 – 76		
4	LPF Cutoff	1kHz – Thru	34 – 60		
5	Output Level	0 – 127	0 – 127		
6					
7	EQ Mid Frequency	100Hz – 10.0kHz	14 – 54	table #3	
8	EQ Mid Gain	-12 – +12dB	52 – 76		
9	EQ Mid Width	1 – 12	10 – 120		
10	Dry/Wet	D63>W – D=W – D<W63	1 – 127		
11	Edge (Clip Curve)	0 – 127	0 – 127		
12					
13					
14					
15					
16					

#### AMP SIMULATOR (Variation, Insertion block)

No.	Parameter	Display	Value	See Table	Control
1	Drive	0 – 127	0 – 127		●
2	AMP Type	Off, Stack, Combo, Tube	0 – 3		
3	LPF Cutoff	1.0k – Thru	34 – 60	table #3	
4	Output Level	0 – 127	0 – 127		
5					
6					
7					
8					
9					
10	Dry/Wet	D63>W – D=W – D<W63	1 – 127		
11	Edge (Clip Curve)	0 – 127	0 – 127	mild – sharp	
12					
13					
14					
15					
16					

### STEREO AMP SIMULATOR (Variation, Insertion block)

No.	Parameter	Display	Value	See Table	Control
1	Drive	0 – 127	0 – 127		●
2	AMP Type	Off, Stack, Combo, Tube	0 – 3		
3	LPF Cutoff	1kHz – Thru	34 – 60		
4	Output Level	0 – 127	0 – 127		
5					
6					
7					
8					
9					
10	Dry/Wet	D63>W – D=W – D<W63	1 – 127		
11	Edge (Clip Curve)	0 – 127	0 – 127		
12					
13					
14					
15					
16					

#### 3BAND EQ (Variation, Insertion block)

No.	Parameter	Display	Value	See Table	Control
1	EQ Low Gain	-12 – +12dB	52 – 76		
2	EQ Mid Frequency	100Hz – 10.0kHz	14 – 54	table #3	
3	EQ Mid Gain	-12 – +12dB	52 – 76		
4	EQ Mid Width	1.0 – 12.0	10 – 120		
5	EQ High Gain	-12 – +12dB	52 – 76		
6	EQ Low Frequency	50Hz – 2.0kHz	8 – 40	table #3	
7	EQ High Frequency	500Hz – 16.0kHz	28 – 58	table #3	
8					
9					
10					
11					
12					
13					
14					
15	Input Mode	mono/stereo	0 – 1		
16					

#### 2BAND EQ (Variation, Insertion block)

No.	Parameter	Display	Value	See Table	Control
1	EQ Low Frequency	32Hz – 2.0kHz	4 – 40	table #3	
2	EQ Low Gain	-12 – +12dB	52 – 76		
3	EQ High Frequency	500Hz – 16.0kHz	28 – 58	table #3	
4	EQ High Gain	-12 – +12dB	52 – 76		
5					
6					
7					
8					
9					
10					
11					
12					
13					
14					
15					
16					

#### AUTO WAH 1, 2 (Variation, Insertion block)

No.	Parameter	Display	Value	See Table	Control
1	LFO Frequency	0.00Hz – 39.7Hz	0 – 127	table #1	
2	LFO Depth	0 – 127	0 – 127		
3	Cutoff Frequency Offset	0 – 127	0 – 127		●
4	Resonance	1.0 – 12.0	10 – 120		
5					
6	EQ Low Frequency	32Hz – 2.0kHz	4 – 40	table #3	
7	EQ Low Gain	-12 – +12dB	52 – 76		
8	EQ High Frequency	500Hz – 16.0kHz	28 – 58	table #3	
9	EQ High Gain	-12 – +12dB	52 – 76		
10	Dry/Wet	D63>W – D=W – D<W63	1 – 127		
11	Drive (variation block)	0 – 127	0 – 127		
12					
13					
14					
15					
16					



**AUTO WAH+DIST**  
**AUTO WHA+ODRV (Variation, Insertion block)**

No.	Parameter	Display	Value	See Table	Control
1	LFO Frequency	0.00Hz – 39.7Hz	0 – 127	table #1	
2	LFO Depth	0 – 127	0 – 127		
3	Cutoff Frequency Offset	0 – 127	0 – 127		●
4	Resonance	1.0 – 12.0	10 – 120		
5					
6	EQ Low Frequency	32Hz – 2.0kHz	4 – 40	table #3	
7	EQ Low Gain	-12 – +12dB	52 – 76		
8	EQ High Frequency	500Hz – 16.0kHz	28 – 58	table #3	
9	EQ High Gain	-12 – +12dB	52 – 76		
10	Dry/Wet	D63>W – D=W – D<W63	1 – 127		
11	Drive	0 – 127	0 – 127		
12	EQ Low Gain (distortion)	-12 – +12dB	52 – 76		
13	EQ Mid Gain (distortion)	-12 – +12dB	52 – 76		
14	LPF Cutoff	1.0kHz – thru	34 – 60	table #3	
15	Output Level	0 – 127	0 – 127		
16					

**PITCH CHANGE 1 (Variation, Insertion block)**

No.	Parameter	Display	Value	See Table	Control
1	Pitch	-24 – +24	40 – 88		
2	Initial Delay	0.1ms – 400.0ms	0 – 127	table #7	
3	Fine 1	-50 – +50	14 – 114		
4	Fine 2	-50 – +50	14 – 114		
5	Feedback Level	-63 – +63	1 – 127		
6					
7					
8					
9					
10	Dry/Wet	D63>W – D=W – D<W63	1 – 127		●
11	Pan 1	L63 – R63	1 – 127		
12	Output Level 1	0 – 127	0 – 127		
13	Pan 2	L63 – R63	1 – 127		
14	Output Level 2	0 – 127	0 – 127		
15					
16					

**PITCH CHANGE 2 (Variation, Insertion block)**

No.	Parameter	Display	Value	See Table	Control
1	Pitch	-24 – +24	40 – 88		
2	Initial Delay	0.1ms – 400.0ms	0 – 127	table #7	
3	Fine 1	-50 – +50cent	14 – 114		
4	Fine 2	-50 – +50cent	14 – 114		
5	Feedback Level	-63 – +63	1 – 127		
6					
7					
8					
9					
10	Dry/Wet	D63>W – D=W – D<W63	1 – 127		●
11	Pan 1	L63 – R63	1 – 127		
12	Output Level 1	0 – 127	0 – 127		
13	Pan 2	L63 – R63	1 – 127		
14	Output Level 2	0 – 127	0 – 127		
15					
16					

**HARMONIC ENHANCER (Variation, Insertion block)**

No.	Parameter	Display	Value	See Table	Control
1	HPF Cutoff	500Hz – 16.0kHz	28 – 58		
2	Drive	0 – 127	0 – 127		
3	Mix Level	0 – 127	0 – 127		
4					
5					
6					
7					
8					
9					
10					
11					
12					
13					
14					
15					
16					

**TOUCH WAH 1**  
**TOUCH WAH+DIST (Variation, Insertion block)**

No.	Parameter	Display	Value	See Table	Control
1	Sensitive	0 – 127	0 – 127		
2	Cutoff Frequency Offset	0 – 127	0 – 127		●
3	Resonance	1.0 – 12.0	10 – 120		
4					
5					
6	EQ Low Frequency	32Hz – 2.0kHz	4 – 40	table #3	
7	EQ Low Gain	-12 – +12dB	52 – 76		
8	EQ High Frequency	500Hz – 16.0kHz	28 – 58	table #3	
9	EQ High Gain	-12 – +12dB	52 – 76		
10	Dry/Wet	D63>W – D=W – D<W63	1 – 127		
11	Drive (variation block)	0 – 127	0 – 127		
12					
13					
14					
15					
16					

**TOUCH WAH 2**  
**TOUCH WAH+ODRV (Variation, Insertion block)**

No.	Parameter	Display	Value	See Table	Control
1	Sensitive	0 – 127	0 – 127		
2	Cutoff Frequency Offset	0 – 127	0 – 127		●
3	Resonance	1.0 – 12.0	10 – 120		
4					
5					
6	EQ Low Frequency	32Hz – 2.0kHz	4 – 40	table #3	
7	EQ Low Gain	-12 – +12dB	52 – 76		
8	EQ High Frequency	500Hz – 16.0kHz	28 – 58	table #3	
9	EQ High Gain	-12 – +12dB	52 – 76		
10	Dry/Wet	D63>W – D=W – D<W63	1 – 127		
11	Drive (variation block)	0 – 127	0 – 127		
12	EQ Low Gain (variation block) (distortion)	-12 – +12dB	52 – 76		
13	EQ Mid Gain (variation block) (distortion)	-12 – +12dB	52 – 76		
14	LPF Cutoff (variation block)	1.0kHz – thru	34 – 60	table #3	
15	Output Level (variation block)	0 – 127	0 – 127		
16	Release (variation block)	10 – 680ms	52 – 67	table #12	

**COMPRESSOR 1, 2 (Variation, Insertion block)**

No.	Parameter	Display	Value	See Table	Control
1	Attack	1 – 40ms	0 – 19	table #8	
2	Release	10 – 680ms	0 – 15	table #9	
3	Threshold	-48 – -6dB	79 – 121		
4	Ratio	1.0 – 20.0	0 – 7	table #10	
5	Output Level	0 – 127	0 – 127		
6					
7					
8					
9					
10					
11					
12					
13					
14					
15					
16					

**NOISE GATE (Variation, Insertion block)**

No.	Parameter	Display	Value	See Table	Control
1	Attack	1 – 40ms	0 – 19	table #8	
2	Release	10 – 680ms	0 – 15	table #9	
3	Threshold	-72 – -30dB	55 – 97		
4	Output Level	0 – 127	0 – 127		
5					
6					
7					
8					
9					
10					
11					
12					
13					
14					
15					
16					

## Effect Parameter List

### VOICE CANCEL (Variation, Insertion block)

No.	Parameter	Display	Value	See Table	Control
1					
2					
3					
4					
5					
6					
7					
8					
9					
10					
11	Low Adjust	0 – 26	0 – 26		
12	High Adjust	0 – 26	0 – 26		
13					
14					
15					
16					

### 2WAY ROTARY SPEAKER (Variation, Insertion block)

No.	Parameter	Display	Value	See Table	Control
1	Rotor Speed	0.0Hz – 39.7Hz	0 – 127	table #1	●
2	Drive Low	0 – 127	0 – 127		
3	Drive High	0 – 127	0 – 127		
4	Low/High	L63>H – L=H – L<H63	1 – 127		
5					
6	EQ Low Frequency	32Hz – 2.0kHz	4 – 40	table #3	
7	EQ Low Gain	-12 – +12dB	52 – 76		
8	EQ High Frequency	500Hz – 16.0kHz	28 – 58	table #3	
9	EQ High Gain	-12 – +12dB	52 – 76		
10					
11	Crossover Frequency	100Hz – 10.0kHz	14 – 54	table #3	
12	Mic L – R Angle	0deg – 180deg (resolution=3deg.)	0 – 60		
13					
14					
15					
16					

### DIST+2WAY ROTARY SPEAKER

### OD+2WAY ROTARY SPEAKER (Variation, Insertion block)

No.	Parameter	Display	Value	See Table	Control
1	Rotor Speed	0.0 – 39.7Hz	0 – 127		●
2	Drive Low	0 – 127	0 – 127		
3	Drive High	0 – 127	0 – 127		
4	Low/High Balance	L63>H – L=H – L<H63	1 – 127		
5					
6	EQ Low Frequency	32 – 2.0kHz	4 – 40		
7	EQ Low Gain	-12 – +12dB	52 – 76		
8	EQ High Frequency	500Hz – 16.0kHz	28 – 58		
9	EQ High Gain	-12 – +12dB	52 – 76		
10					
11	Crossover Frequency	100Hz – 10.0kHz	14 – 54		
12	Mic L – R Angle	0 – 180deg	0 – 60		
13					
14	Drive		0 – 127		
15	LPF Cutoff	1kHz – Thru	34 – 60		
16	Output Level		0 – 127		

### AMP SIM.+2WAY ROTARY SP (Variation, Insertion block)

No.	Parameter	Display	Value	See Table	Control
1	Rotor Speed	0.0 – 39.7Hz	0 – 127		●
2	Drive Low	0 – 127	0 – 127		
3	Drive High	0 – 127	0 – 127		
4	Low/High Balance	L63>H – L=H – L<H63	1 – 127		
5					
6	EQ Low Frequency	32Hz – 2.0kHz	4 – 40		
7	EQ Low Gain	-12 – +12dB	52 – 76		
8	EQ High Frequency	500Hz – 16.0kHz	28 – 58		
9	EQ High Gain	-12 – +12dB	52 – 76		
10					
11	Crossover Frequency	100Hz – 10.0kHz	14 – 54		
12	Mic L – R Angle	0 – 180deg	0 – 60		
13	AMP Type	Off, Stack, Combo, Tube (AMP SIM only)	0 – 3		
14	Drive		0 – 127		
15	LPF Cutoff	1kHz – Thru	34 – 60		
16	Output Level		0 – 127		

### ENSEMBLE DETUNE (Chorus, Variation, Insertion block)

No.	Parameter	Display	Value	See Table	Control
1	Detune	-50 – +50cent	14 – 114		
2	Lch Init Delay	0.0mS – 50mS	0 – 127	table #2	
3	Rch Init Delay	0.0mS – 50mS	0 – 127	table #2	
4					
5					
6					
7					
8					
9					
10	Dry/Wet	D63>W – D=W – D<W63	1 – 127		●
11	EQ Low Frequency	32Hz – 2.0kHz	4 – 40	table #3	
12	EQ Low Gain	-12 – +12dB	52 – 76		
13	EQ High Frequency	500Hz – 16.0kHz	28 – 58	table #3	
14	EQ High Gain	-12 – +12dB	52 – 76		
15					
16					

### AMBIENCE (Variation, Insertion block)

No.	Parameter	Display	Value	See Table	Control
1	Delay Time	0.0mS – 50mS	0 – 127	table #2	
2	Output Phase	normal/inverse	0 – 1		
3					
4					
5					
6	EQ Low Frequency	32Hz – 2.0kHz	4 – 40	table #3	
7	EQ Low Gain	-12 – +12dB	52 – 76		
8	EQ High Frequency	500Hz – 16.0kHz	28 – 58	table #3	
9	EQ High Gain	-12 – +12dB	52 – 76		
10	Dry/Wet	D63>W – D=W – D<W63	1 – 127		●
11					
12					
13					
14					
15					
16					

### TALKING MODULATION (Variation, Insertion block)

No.	Parameter	Display	Value	See Table	Control
1	Vowel	a, i, u, e, o	0 – 4		●
2	Move speed	1 – 62	1 – 62		
3	Drive	0 – 127	0 – 127		
4	Output Level	0 – 127	0 – 127		
5					
6					
7					
8					
9					
10					
11					
12					
13					
14					
15					
16					

### LO-FI (Variation, Insertion block)

No.	Parameter	Display	Value	See Table	Control
1	Sampling Freq Control	44.1kHz – 345Hz	0 – 127	table #13	
2	Word Length	1 – 127	1 – 127		
3	Output Gain	-6 – +12dB	0 – 18		
4	LPF Cutoff	63Hz – Thru	10 – 60	table #3	
5	Filter Type	Thru, PowerBass, Radio, Tel, Clean, Low	0 – 5		
6	LPF Resonance	1.0 – 12.0	10 – 120		
7	Bit Assign	0 – 6	0 – 6		
8	Emphasis	Off/On	0 – 1		
9					
10	Dry/Wet	D63>W – D=W – D<W63	1 – 127		●
11					
12					
13					
14					
15	Input Mode	mono/stereo			
16					

**DIST+DELAY**  
**OVERDRIVE+DELAY (Variation, Insertion block)**

No.	Parameter	Display	Value	See Table	Control
1	Lch Delay Time	0.1 – 1638.3ms	1 – 16383		
2	Rch Delay Time	0.1 – 1638.3ms	1 – 16383		
3	Delay Feedback Time	0.1 – 1638.3ms	1 – 16383		
4	Delay Feedback Level	-63 – +63	1 – 127		
5	Delay Mix	0 – 127	0 – 127		
6	Dist Drive	0 – 127	0 – 127		
7	Dist Output Level	0 – 127	0 – 127		
8	Dist EQ Low Gain	-12 – +12dB	52 – 76		
9	Dist EQ Mid Gain	-12 – +12dB	52 – 76		
10	Dry/Wet	D63>W – D=W – D<W63	1 – 127		●
11					
12					
13					
14					
15					
16					

**COMP+DIST+DELAY**  
**COMP+OVERDRIVE+DELAY (Variation, Insertion block)**

No.	Parameter	Display	Value	See Table	Control
1	Delay Time	0.1 – 1638.3ms	1 – 16383		
2	Delay Feedback Level	-63 – +63	1 – 127		
3	Delay Mix	0 – 127	0 – 127		
4	Dist Drive	0 – 127	0 – 127		
5	Dist Output Level	0 – 127	0 – 127		
6	Dist EQ Low Gain	-12 – +12dB	52 – 76		
7	Dist EQ Mid Gain	-12 – +12dB	52 – 76		
8					
9					
10	Dry/Wet	D63>W – D=W – D<W63	1 – 127		●
11	Comp. Attack	1ms – 40ms	0 – 19	table #8	
12	Comp. Release	10ms – 680ms	0 – 15	table #9	
13	Comp. Threshold	-48dB – -6dB	79 – 121		
14	Comp. Ratio	1.0 – 20.0	0 – 7	table #10	
15					
16					

**WAH+DIST+DELAY**  
**WAH+OVERDRIVE+DELAY (Variation, Insertion block)**

No.	Parameter	Display	Value	See Table	Control
1	Delay Time	0.1 – 1638.3ms	1 – 16383		
2	Delay Feedback Level	-63 – +63	1 – 127		
3	Delay Mix	0 – 127	0 – 127		
4	Dist Drive	0 – 127	0 – 127		
5	Dist Output Level	0 – 127	0 – 127		
6	Dist EQ Low Gain	-12 – +12dB	52 – 76		
7	Dist EQ Mid Gain	-12 – +12dB	52 – 76		
8					
9					
10	Dry/Wet	D63>W – D=W – D<W63	1 – 127		●
11	Wah Sensitive	0 – 127	0 – 127		
12	Wah Cutoff Freq Offset	0 – 127	0 – 127		
13	Wah Resonance	1.0 – 12.0	10 – 120		
14	Wah Release	10 – 680ms	52 – 67	table #12	
15					
16					

**V DISTORTION HARD**  
**V DISTORTION SOFT (Variation, Insertion block)**

No.	Parameter	Display	Value	See Table	Control
1	Overdrive	0 – 100%	0 – 100		
2	Device	Transistor/Vintage Tube/ Dist1/Dist2/Fuzz	0 – 4		
3	Speaker	Flat/Stack/Combo/Twin/ Radio/Megaphone	0 – 5		
4	Presence	0 – 20	0 – 20		
5	Output Level	0 – 100%	0 – 100		
6					
7					
8					
9					
10	Dry/Wet Balance	D63>W – D=W – D<W63	1 – 127		●
11					
12					
13					
14					
15					
16					

**V DISTORTION HARD+DELAY**  
**V DISTORTION SOFT+DELAY (Variation, Insertion block)**

No.	Parameter	Display	Value	See Table	Control
1	Overdrive	0 – 100%	0 – 100		
2	Device	Transistor/Vintage Tube/ Dist1/Dist2/Fuzz	0 – 4		
3	Speaker	Flat/Stack/Combo/Twin/ Radio/Megaphone	0 – 5		
4	Presence	0 – 20	0 – 20		
5	Output Level	0 – 100%	0 – 100		
6	Delay Time L	0.1ms – 1486.0ms	1 – 14860		
7	Delay Time R	0.1ms – 1486.0ms	1 – 14860		
8	Delay Feedback Time	0.1ms – 1486.0ms	1 – 14860		
9	Delay Feedback Level	-63 – +63	1 – 127		
10	Dry/Wet Balance	D63>W – D=W – D<W63	1 – 127		●
11	Delay Mix	0 – 127	0 – 127		
12					
13					
14					
15					
16					

**DUAL ROTOR SPEAKER1, 2 (Variation, Insertion block)**

No.	Parameter	Display	Value	See Table	Control
1	Rotor Speed Slow	0.0 – 2.65Hz	0 – 63	table #1	
2	Horn Speed Slow	0.0 – 2.65Hz	0 – 63	table #1	
3	Rotor Speed Fast	2.69 – 39.7Hz	64 – 127	table #1	
4	Horn Speed Fast	2.69 – 39.7Hz	64 – 127	table #1	
5	Slow-Fast Time of R	0 – 127	0 – 127		
6	Slow-Fast Time of H	0 – 127	0 – 127		
7	Drive Low	0 – 127	0 – 127		
8	Drive High	0 – 127	0 – 127		
9	Low/High Balance	L63>H – L=H – L<H=63	1 – 127		
10					
11	EQ Low Frequency	32Hz – 2.0kHz	4 – 40	table #3	
12	EQ Low Gain	-12 – +12dB	52 – 76		
13	EQ High Frequency	500Hz – 16.0kHz	28 – 58	table #3	
14	EQ High Gain	-12 – +12dB	52 – 76		
15	Mic L-R Angle	0 – 180deg	0 – 60		
16	Speed Control	Slow/Fast	0/1		●

**DIST+TEMPO DELAY**  
**OVERDRIVE+TEMPO DELAY (Variation, Insertion block)**

No.	Parameter	Display	Value	See Table	Control
1	Delay Time	64th/3 – 4thx6	0 – 19	table #14	
2	Delay Feedback Level	-63 – +63	1 – 127		
3	Delay Mix	0 – 127	0 – 127		
4	Dist Drive	0 – 127	0 – 127		
5	Dist Output Level	0 – 127	0 – 127		
6	Dist EQ Low Gain	-12 – +12dB	52 – 76		
7	Dist EQ High Gain	-12 – +12dB	52 – 76		
8	L/R Diffusion	1 (-63ms) – 64 (0ms) – 127 (63ms)	1 – 127		
9	Lag	1 (-63ms) – 64 (0ms) – 127 (63ms)	1 – 127		
10	Dry/Wet	D63>W – D=W – D<W63	1 – 127		●
11					
12					
13					
14					
15					
16					

**COMP+DIST+TEMPO DELAY**  
**COMP+OD+TEMPO DELAY (Variation, Insertion block)**

No.	Parameter	Display	Value	See Table	Control
1	Delay Time	64th/3 – 4thx6	0 – 19	table #14	
2	Delay Feedback Level	-63 – +63	1 – 127		
3	Delay Mix	0 – 127	0 – 127		
4	Dist Drive	0 – 127	0 – 127		
5	Dist Output Level	0 – 127	0 – 127		
6	Dist EQ Low Gain	-12 – +12dB	52 – 76		
7	Dist EQ High Gain	-12 – +12dB	52 – 76		
8	L/R Diffusion	1 (-63ms) – 64 (0ms) – 127 (63ms)	1 – 127		
9	Lag	1 (-63ms) – 64 (0ms) – 127 (63ms)	1 – 127		
10	Dry/Wet	D63>W – D=W – D<W63	1 – 127		●
11	Comp. Attack	1ms – 40ms	0 – 19		
12	Comp. Release	10ms – 680ms	0 – 15		
13	Comp. Threshold	-48dB – -6dB	79 – 121		
14	Comp. Ratio	1.0 – 20.0	0 – 7		
15					
16					

## Effect Parameter List

### WAH+DIST+TEMPO DELAY

#### WAH+OD+TEMPO DELAY (Variation, Insertion block)

No.	Parameter	Display	Value	See Table	Control	
1	Delay Time	64th/3 – 4thx6	0 – 19	table #14		
2	Delay Feedback Level	-63 – +63	1 – 127			
3	Delay Mix	0 – 127	0 – 127			
4	Dist Drive	0 – 127	0 – 127			
5	Dist Output Level	0 – 127	0 – 127			
6	Dist EQ Low Gain	-12 – +12dB	52 – 76			
7	Dist EQ High Gain	-12 – +12dB	52 – 76			
8	L/R Diffusion	1 (-63ms) – 64 (0ms) – 127 (63ms)	1 – 127			
9	Lag	1 (-63ms) – 64 (0ms) – 127 (63ms)	1 – 127			
10	Dry/Wet	D63>W – D=W – D<W63	1 – 127			●
11	Wah Sensitive	0 – 127	0 – 127			
12	Wah Cutoff Freq Offset	0 – 127	0 – 127			
13	Wah Resonance	1.0 – 12.0	10 – 120			
14	Wah Release	10 – 680mS	52 – 67			
15						
16						

### V DIST HARD+TEMPO DELAY

#### V DIST SOFT+TEMPO DELAY (Variation, Insertion block)

No.	Parameter	Display	Value	See Table	Control	
1	Overdrive	0 – 100%	0 – 100	table #14		
2	Device	Transistor/Vintage Tube/ Dist1/Dist2/Fuzz	0 – 4			
3	Speaker	Flat/Stack/Combo/Twin/ Radio/Megaphone	0 – 5			
4	Presence	0 – 20	0 – 20			
5	Output Level	0 – 100%	0 – 100			
6	Delay Time	64th/3 – 4thx6	0 – 19			
7	Delay Feedback Level	-63 – +63	1 – 127			
8	L/R Diffusion	1 (-63ms) – 64 (0ms) – 127 (63ms)	1 – 127			
9	Lag	1 (-63ms) – 64 (0ms) – 127 (63ms)	1 – 127			
10	Dry/Wet Balance	D63>W – D=W – D<W63	1 – 127			●
11	Delay Mix	0 – 127	0 – 127			
12						
13						
14						
15						
16						

### VIBE ROTOR (Variation, Insertion block)

No.	Parameter	Display	Value	See Table	Control
1	Vibrate Speed	0.00Hz – 39.7Hz	0 – 127	table #1	
2	Vibrate Depth (AM)	0 – 127	0 – 127		
3	Vibrate Depth (PM)	0 – 127	0 – 127		
4				table #3	
5					
6	EQ Low Frequency	32Hz – 2.0kHz	4 – 40		
7	EQ Low Gain	-12 – +12dB	52 – 76		
8	EQ High Frequency	500Hz – 16.0kHz	28 – 58		
9	EQ High Gain	-12 – +12dB	52 – 76		
10	Dry/Wet Balance	D63>W – D=W – D<W63	1 – 127		
11				table #3	
12					
13					
14	LFO Phase Difference	-180 – +180deg (resolution=3deg.)	4 – 124		
15	Input Mode	mono/stereo	0 – 1		
16	Vibrate SW	OFF, ON	0 – 1		

### NO EFFECT (Reverb, Chorus, Variation)

#### THRU (Insertion block)

No.	Parameter	Display	Value	See Table	Control
1					
2					
3					
4					
5					
6					
7					
8					
9					
10					
11					
12					
13					
14					
15					
16					

\* Parameter 10 Dry/Wet only affects insertion type effects.

# Effect Data Assign Table

**Table #1**  
**LFO Frequency**

Data	Value	Data	Value
0	0.00	64	2.69
1	0.04	65	2.78
2	0.08	66	2.86
3	0.13	67	2.94
4	0.17	68	3.03
5	0.21	69	3.11
6	0.25	70	3.20
7	0.29	71	3.28
8	0.34	72	3.37
9	0.38	73	3.45
10	0.42	74	3.53
11	0.46	75	3.62
12	0.51	76	3.70
13	0.55	77	3.87
14	0.59	78	4.04
15	0.63	79	4.21
16	0.67	80	4.37
17	0.72	81	4.54
18	0.76	82	4.71
19	0.80	83	4.88
20	0.84	84	5.05
21	0.88	85	5.22
22	0.93	86	5.38
23	0.97	87	5.55
24	1.01	88	5.72
25	1.05	89	6.06
26	1.09	90	6.39
27	1.14	91	6.73
28	1.18	92	7.07
29	1.22	93	7.40
30	1.26	94	7.74
31	1.30	95	8.08
32	1.35	96	8.41
33	1.39	97	8.75
34	1.43	98	9.08
35	1.47	99	9.42
36	1.51	100	9.76
37	1.56	101	10.1
38	1.60	102	10.8
39	1.64	103	11.4
40	1.68	104	12.1
41	1.72	105	12.8
42	1.77	106	13.5
43	1.81	107	14.1
44	1.85	108	14.8
45	1.89	109	15.5
46	1.94	110	16.2
47	1.98	111	16.8
48	2.02	112	17.5
49	2.06	113	18.2
50	2.10	114	19.5
51	2.15	115	20.9
52	2.19	116	22.2
53	2.23	117	23.6
54	2.27	118	24.9
55	2.31	119	26.2
56	2.36	120	27.6
57	2.40	121	28.9
58	2.44	122	30.3
59	2.48	123	31.6
60	2.52	124	33.0
61	2.57	125	34.3
62	2.61	126	37.0
63	2.65	127	39.7

**Table #2**  
**Modulation Delay Offset**

Data	Value	Data	Value
0	0.0	64	6.4
1	0.1	65	6.5
2	0.2	66	6.6
3	0.3	67	6.7
4	0.4	68	6.8
5	0.5	69	6.9
6	0.6	70	7.0
7	0.7	71	7.1
8	0.8	72	7.2
9	0.9	73	7.3
10	1.0	74	7.4
11	1.1	75	7.5
12	1.2	76	7.6
13	1.3	77	7.7
14	1.4	78	7.8
15	1.5	79	7.9
16	1.6	80	8.0
17	1.7	81	8.1
18	1.8	82	8.2
19	1.9	83	8.3
20	2.0	84	8.4
21	2.1	85	8.5
22	2.2	86	8.6
23	2.3	87	8.7
24	2.4	88	8.8
25	2.5	89	8.9
26	2.6	90	9.0
27	2.7	91	9.1
28	2.8	92	9.2
29	2.9	93	9.3
30	3.0	94	9.4
31	3.1	95	9.5
32	3.2	96	9.6
33	3.3	97	9.7
34	3.4	98	9.8
35	3.5	99	9.9
36	3.6	100	10.0
37	3.7	101	11.1
38	3.8	102	12.2
39	3.9	103	13.3
40	4.0	104	14.4
41	4.1	105	15.5
42	4.2	106	17.1
43	4.3	107	18.6
44	4.4	108	20.2
45	4.5	109	21.8
46	4.6	110	23.3
47	4.7	111	24.9
48	4.8	112	26.5
49	4.9	113	28.0
50	5.0	114	29.6
51	5.1	115	31.2
52	5.2	116	32.8
53	5.3	117	34.3
54	5.4	118	35.9
55	5.5	119	37.5
56	5.6	120	39.0
57	5.7	121	40.6
58	5.8	122	42.2
59	5.9	123	43.7
60	6.0	124	45.3
61	6.1	125	46.9
62	6.2	126	48.4
63	6.3	127	50.0

**Table #3**  
**EQ Frequency**

Data	Value
0	THRU (0)
1	22
2	25
3	28
4	32
5	36
6	40
7	45
8	50
9	56
10	63
11	70
12	80
13	90
14	100
15	110
16	125
17	140
18	160
19	180
20	200
21	225
22	250
23	280
24	315
25	355
26	400
27	450
28	500
29	560
30	630
31	700
32	800
33	900
34	1.0k
35	1.1k
36	1.2k
37	1.4k
38	1.6k
39	1.8k
40	2.0k
41	2.2k
42	2.5k
43	2.8k
44	3.2k
45	3.6k
46	4.0k
47	4.5k
48	5.0k
49	5.6k
50	6.3k
51	7.0k
52	8.0k
53	9.0k
54	10.0k
55	11.0k
56	12.0k
57	14.0k
58	16.0k
59	18.0k
60	THRU (20.0k)

**Table #4**  
**Reverb Time**

Data	Value	Data	Value
0	0.3	64	17.0
1	0.4	65	18.0
2	0.5	66	19.0
3	0.6	67	20.0
4	0.7	68	25.0
5	0.8	69	30.0
6	0.9		
7	1.0		
8	1.1		
9	1.2		
10	1.3		
11	1.4		
12	1.5		
13	1.6		
14	1.7		
15	1.8		
16	1.9		
17	2.0		
18	2.1		
19	2.2		
20	2.3		
21	2.4		
22	2.5		
23	2.6		
24	2.7		
25	2.8		
26	2.9		
27	3.0		
28	3.1		
29	3.2		
30	3.3		
31	3.4		
32	3.5		
33	3.6		
34	3.7		
35	3.8		
36	3.9		
37	4.0		
38	4.1		
39	4.2		
40	4.3		
41	4.4		
42	4.5		
43	4.6		
44	4.7		
45	4.8		
46	4.9		
47	5.0		
48	5.5		
49	6.0		
50	6.5		
51	7.0		
52	7.5		
53	8.0		
54	8.5		
55	9.0		
56	9.5		
57	10.0		
58	11.0		
59	12.0		
60	13.0		
61	14.0		
62	15.0		
63	16.0		

**Table #5**  
**Delay Time (200.0ms)**

Data	Value	Data	Value
0	0.1	64	100.8
1	1.7	65	102.4
2	3.2	66	104.0
3	4.8	67	105.6
4	6.4	68	107.1
5	8.0	69	108.7
6	9.5	70	110.3
7	11.1	71	111.9
8	12.7	72	113.4
9	14.3	73	115.0
10	15.8	74	116.6
11	17.4	75	118.2
12	19.0	76	119.7
13	20.6	77	121.3
14	22.1	78	122.9
15	23.7	79	124.4
16	25.3	80	126.0
17	26.9	81	127.6
18	28.4	82	129.2
19	30.0	83	130.7
20	31.6	84	132.3
21	33.2	85	133.9
22	34.7	86	135.5
23	36.3	87	137.0
24	37.9	88	138.6
25	39.5	89	140.2
26	41.0	90	141.8
27	42.6	91	143.3
28	44.2	92	144.9
29	45.7	93	146.5
30	47.3	94	148.1
31	48.9	95	149.6
32	50.5	96	151.2
33	52.0	97	152.8
34	53.6	98	154.4
35	55.2	99	155.9
36	56.8	100	157.5
37	58.3	101	159.1
38	59.9	102	160.6
39	61.5	103	162.2
40	63.1	104	163.8
41	64.6	105	165.4
42	66.2	106	166.9
43	67.8	107	168.5
44	69.4	108	170.1
45	70.9	109	171.7
46	72.5	110	173.2
47	74.1	111	174.8
48	75.7	112	176.4
49	77.2	113	178.0
50	78.8	114	179.5
51	80.4	115	181.1
52	81.9	116	182.7
53	83.5	117	184.3
54	85.1	118	185.8
55	86.7	119	187.4
56	88.2	120	189.0
57	89.8	121	190.6
58	91.4	122	192.1
59	93.0	123	193.7
60	94.5	124	195.3
61	96.1	125	196.9
62	97.7	126	198.4
63	99.3	127	200.0

Effect Data Assign Table

Table #6  
Room Size

Data	Value	Data	Value
0	0.1	64	10.1
1	0.3	65	10.3
2	0.4	66	10.4
3	0.6	67	10.6
4	0.7	68	10.8
5	0.9	69	10.9
6	1.0	70	11.1
7	1.2	71	11.2
8	1.4	72	11.4
9	1.5	73	11.5
10	1.7	74	11.7
11	1.8	75	11.9
12	2.0	76	12.0
13	2.1	77	12.2
14	2.3	78	12.3
15	2.5	79	12.5
16	2.6	80	12.6
17	2.8	81	12.8
18	2.9	82	12.9
19	3.1	83	13.1
20	3.2	84	13.3
21	3.4	85	13.4
22	3.5	86	13.6
23	3.7	87	13.7
24	3.9	88	13.9
25	4.0	89	14.0
26	4.2	90	14.2
27	4.3	91	14.4
28	4.5	92	14.5
29	4.6	93	14.7
30	4.8	94	14.8
31	5.0	95	15.0
32	5.1	96	15.1
33	5.3	97	15.3
34	5.4	98	15.5
35	5.6	99	15.6
36	5.7	100	15.8
37	5.9	101	15.9
38	6.1	102	16.1
39	6.2	103	16.2
40	6.4	104	16.4
41	6.5	105	16.6
42	6.7	106	16.7
43	6.8	107	16.9
44	7.0	108	17.0
45	7.2	109	17.2
46	7.3	110	17.3
47	7.5	111	17.5
48	7.6	112	17.6
49	7.8	113	17.8
50	7.9	114	18.0
51	8.1	115	18.1
52	8.2	116	18.3
53	8.4	117	18.4
54	8.6	118	18.6
55	8.7	119	18.7
56	8.9	120	18.9
57	9.0	121	19.1
58	9.2	122	19.2
59	9.3	123	19.4
60	9.5	124	19.5
61	9.7	125	19.7
62	9.8	126	19.8
63	10.0	127	20.0

Table #7  
Delay Time (400.0ms)

Data	Value	Data	Value
0	0.1	64	201.6
1	3.2	65	204.8
2	6.4	66	207.9
3	9.5	67	211.1
4	12.7	68	214.2
5	15.8	69	217.4
6	19.0	70	220.5
7	22.1	71	223.7
8	25.3	72	226.8
9	28.4	73	230.0
10	31.6	74	233.1
11	34.7	75	236.3
12	37.9	76	239.4
13	41.0	77	242.6
14	44.2	78	245.7
15	47.3	79	248.9
16	50.5	80	252.0
17	53.6	81	255.2
18	56.8	82	258.3
19	59.9	83	261.5
20	63.1	84	264.6
21	66.2	85	267.7
22	69.4	86	270.9
23	72.5	87	274.0
24	75.7	88	277.2
25	78.8	89	280.3
26	82.0	90	283.5
27	85.1	91	286.6
28	88.3	92	289.8
29	91.4	93	292.9
30	94.6	94	296.1
31	97.7	95	299.2
32	100.9	96	302.4
33	104.0	97	305.5
34	107.2	98	308.7
35	110.3	99	311.8
36	113.5	100	315.0
37	116.6	101	318.1
38	119.8	102	321.3
39	122.9	103	324.4
40	126.1	104	327.6
41	129.2	105	330.7
42	132.4	106	333.9
43	135.5	107	337.0
44	138.6	108	340.2
45	141.8	109	343.3
46	144.9	110	346.5
47	148.1	111	349.6
48	151.2	112	352.8
49	154.4	113	355.9
50	157.5	114	359.1
51	160.7	115	362.2
52	163.8	116	365.4
53	167.0	117	368.5
54	170.1	118	371.7
55	173.3	119	374.8
56	176.4	120	378.0
57	179.6	121	381.1
58	182.7	122	384.3
59	185.9	123	387.4
60	189.0	124	390.6
61	192.2	125	393.7
62	195.3	126	396.9
63	198.5	127	400.0

Table #8  
Compressor Attack Time

Data	Value	Data	Value
0	1	10	12
1	2	11	14
2	3	12	16
3	4	13	18
4	5	14	20
5	6	15	23
6	7	16	26
7	8	17	30
8	9	18	35
9	10	19	40

Table #9  
Compressor Release Time

Data	Value	Data	Value
0	10	8	85
1	15	9	100
2	25	10	115
3	35	11	140
4	45	12	170
5	55	13	230
6	65	14	340
7	75	15	680

Table #10  
Compressor Ratio

Data	Value	Data	Value
0	1.0	4	5.0
1	1.5	5	7.0
2	2.0	6	10.0
3	3.0	7	20.0

Table #11  
Reverb Width; Depth; Height

Data	Value	Data	Value
0	0.5	64	17.6
1	0.8	65	17.9
2	1.0	66	18.2
3	1.3	67	18.5
4	1.5	68	18.8
5	1.8	69	19.1
6	2.0	70	19.4
7	2.3	71	19.7
8	2.6	72	20.0
9	2.8	73	20.2
10	3.1	74	20.5
11	3.3	75	20.8
12	3.6	76	21.1
13	3.9	77	21.4
14	4.1	78	21.7
15	4.4	79	22.0
16	4.6	80	22.4
17	4.9	81	22.7
18	5.2	82	23.0
19	5.4	83	23.3
20	5.7	84	23.6
21	5.9	85	23.9
22	6.2	86	24.2
23	6.5	87	24.5
24	6.7	88	24.9
25	7.0	89	25.2
26	7.2	90	25.5
27	7.5	91	25.8
28	7.8	92	26.1
29	8.0	93	26.5
30	8.3	94	26.8
31	8.6	95	27.1
32	8.8	96	27.5
33	9.1	97	27.8
34	9.4	98	28.1
35	9.6	99	28.5
36	9.9	100	28.8
37	10.2	101	29.2
38	10.4	102	29.5
39	10.7	103	29.9
40	11.0	104	30.2
41	11.2		
42	11.5		
43	11.8		
44	12.1		
45	12.3		
46	12.6		
47	12.9		
48	13.1		
49	13.4		
50	13.7		
51	14.0		
52	14.2		
53	14.5		
54	14.8		
55	15.1		
56	15.4		
57	15.6		
58	15.9		
59	16.2		
60	16.5		
61	16.8		
62	17.1		
63	17.3		

Table #12  
Wah Release Time

Data	Value
52	10.0
53	15.0
54	25.0
55	35.0
56	45.0
57	55.0
58	65.0
59	75.0
60	85.0
61	100.0
62	115.0
63	140.0
64	170.0
65	230.0
66	340.0
67	680.0

Table #13  
Sampling Freq Control

Data	Value	Data	Value
0	44.1K	64	678.0
1	22.1K	65	668.0
2	14.7K	66	658.0
3	11.0K	67	649.0
4	8.8K	68	639.0
5	7.4K	69	630.0
6	6.3K	70	621.0
7	5.5K	71	613.0
8	4.9K	72	604.0
9	4.5K	73	596.0
10	4.0K	74	588.0
11	3.7K	75	580.0
12	3.4K	76	573.0
13	3.2K	77	565.0
14	2.9K	78	558.0
15	2.8K	79	551.0
16	2.6K	80	544.0
17	2.5K	81	538.0
18	2.3K	82	531.0
19	2.2K	83	525.0
20	2.1K	84	519.0
21	2.0K	85	513.0
22	1.92K	86	507.0
23	1.84K	87	501.0
24	1.76K	88	496.0
25	1.70K	89	490.0
26	1.63K	90	485.0
27	1.58K	91	479.0
28	1.52K	92	474.0
29	1.47K	93	469.0
30	1.42K	94	464.0
31	1.38K	95	459.0
32	1.34K	96	455.0
33	1.30K	97	450.0
34	1.26K	98	445.0
35	1.23K	99	441.0
36	1.19K	100	437.0
37	1.16K	101	432.0
38	1.13K	102	428.0
39	1.10K	103	424.0
40	1.08K	104	420.0
41	1.05K	105	416.0
42	1.03K	106	412.0
43	1.00K	107	408.0
44	980.0	108	405.0
45	959.0	109	401.0
46	938.0	110	397.0
47	919.0	111	394.0
48	900.0	112	390.0
49	882.0	113	387.0
50	865.0	114	383.0
51	848.0	115	380.0
52	832.0	116	377.0
53	817.0	117	374.0
54	802.0	118	371.0
55	788.0	119	368.0
56	774.0	120	364.0
57	760.0	121	361.0
58	747.0	122	359.0
59	735.0	123	356.0
60	723.0	124	353.0
61	711.0	125	350.0
62	700.0	126	347.0
63	689.0	127	345.0

Table #14  
Tempo Delay

Data	Value	Data	Value
0	64th/3	64	4thX51
1	64th.	65	4thX52
2	32th	66	4thX53
3	32th/3	67	4thX54
4	32th.	68	4thX55
5	16th	69	4thX56
6	16th/3	70	4thX57
7	16th.	71	4thX58
8	8th	72	4thX59
9	8th/3	73	4thX60
10	8th.	74	4thX61
11	4th	75	4thX62
12	4th/3	76	4thX63
13	4th.	77	4thX64
14	2nd		
15	2nd/3		
16	2nd.		
17	4thX4		
18	4thX5		
19			

# MIDI Data Format

Many MIDI messages listed in the MIDI Data Format are expressed in decimal numbers, binary numbers and hexadecimal numbers. Hexadecimal numbers may include the letter "H" as a suffix. Also, "n" can freely be defined as any whole number. To enter data/values, refer to the table below.

Decimal	Hexa-decimal	Binary
0	00	0000 0000
1	01	0000 0001
2	02	0000 0010
3	03	0000 0011
4	04	0000 0100
5	05	0000 0101
6	06	0000 0110
7	07	0000 0111
8	08	0000 1000
9	09	0000 1001
10	0A	0000 1010
11	0B	0000 1011
12	0C	0000 1100
13	0D	0000 1101
14	0E	0000 1110
15	0F	0000 1111
16	10	0001 0000
17	11	0001 0001
18	12	0001 0010
19	13	0001 0011
20	14	0001 0100
21	15	0001 0101
22	16	0001 0110
23	17	0001 0111
24	18	0001 1000
25	19	0001 1001
26	1A	0001 1010
27	1B	0001 1011
28	1C	0001 1100
29	1D	0001 1101
30	1E	0001 1110
31	1F	0001 1111

Decimal	Hexa-decimal	Binary
32	20	0010 0000
33	21	0010 0001
34	22	0010 0010
35	23	0010 0011
36	24	0010 0100
37	25	0010 0101
38	26	0010 0110
39	27	0010 0111
40	28	0010 1000
41	29	0010 1001
42	2A	0010 1010
43	2B	0010 1011
44	2C	0010 1100
45	2D	0010 1101
46	2E	0010 1110
47	2F	0010 1111
48	30	0011 0000
49	31	0011 0001
50	32	0011 0010
51	33	0011 0011
52	34	0011 0100
53	35	0011 0101
54	36	0011 0110
55	37	0011 0111
56	38	0011 1000
57	39	0011 1001
58	3A	0011 1010
59	3B	0011 1011
60	3C	0011 1100
61	3D	0011 1101
62	3E	0011 1110
63	3F	0011 1111

Decimal	Hexa-decimal	Binary
64	40	0100 0000
65	41	0100 0001
66	42	0100 0010
67	43	0100 0011
68	44	0100 0100
69	45	0100 0101
70	46	0100 0110
71	47	0100 0111
72	48	0100 1000
73	49	0100 1001
74	4A	0100 1010
75	4B	0100 1011
76	4C	0100 1100
77	4D	0100 1101
78	4E	0100 1110
79	4F	0100 1111
80	50	0101 0000
81	51	0101 0001
82	52	0101 0010
83	53	0101 0011
84	54	0101 0100
85	55	0101 0101
86	56	0101 0110
87	57	0101 0111
88	58	0101 1000
89	59	0101 1001
90	5A	0101 1010
91	5B	0101 1011
92	5C	0101 1100
93	5D	0101 1101
94	5E	0101 1110
95	5F	0101 1111

Decimal	Hexa-decimal	Binary
96	60	0110 0000
97	61	0110 0001
98	62	0110 0010
99	63	0110 0011
100	64	0110 0100
101	65	0110 0101
102	66	0110 0110
103	67	0110 0111
104	68	0110 1000
105	69	0110 1001
106	6A	0110 1010
107	6B	0110 1011
108	6C	0110 1100
109	6D	0110 1101
110	6E	0110 1110
111	6F	0110 1111
112	70	0111 0000
113	71	0111 0001
114	72	0111 0010
115	73	0111 0011
116	74	0111 0100
117	75	0111 0101
118	76	0111 0110
119	77	0111 0111
120	78	0111 1000
121	79	0111 1001
122	7A	0111 1010
123	7B	0111 1011
124	7C	0111 1100
125	7D	0111 1101
126	7E	0111 1110
127	7F	0111 1111

- Except the table above, for example 144-159 (decimal)/9nH/1001 0000-1001 1111 (binary) denotes the Note On Message for each channel (1-16). 176-191/BnH/1011 0000-1011 1111 denotes the Control Change Message for each channel (1-16). 192-207/CnH/1100 0000-1100 1111 denotes the Program Change Message for each channel (1-16). 240/FOH/1111 0000 denotes the start of a System Exclusive Message. 247/F7H/1111 0111 denotes the end of a System Exclusive Message.
- aaH (hexadecimal)/0aaaaaaa (binary) denotes the data address. The address contains High, Mid, and Low.
- bbH/0bbbbbbb denotes the byte count.
- ccH/0ccccccc denotes the check sum.
- ddH/0ddddddd denotes the data/value.

# MIDI CHANNEL MESSAGE (1)

MIDI Events	Status byte		1st Data byte		2nd Data byte		MIDI Reception (respond/ignore)			MIDI Transmission (generated data)			REC	
	Status		Data (HEX)	Parameter	Data (HEX)	Parameter	Song	Main Layer Left Layer	Keyboard	Panel (main generation method)	Song	Midi	Recorded from panel	
Key Off	8nH	(n: Channel Number)	kk	Key no. (0 – 127)	vv	Velocity (0 – 127)	○	○	○	×	○	×	×	
Key On	9nH	(n: Channel Number)	kk	Key no. (0 – 127)	vv	Key On: vv=1 – 127 Key Off: vv=0	○	○	○	○ (Keyboard)	○	×	○	
Control Change	BnH	(n: Channel Number)	0 (00H)	Bank Select MSB	0 (00H) 64 (40H) 126 (7EH) 127 (7FH)	Normal SFX Voice SFX kit Drum kit	○	○	×	○ (Voice)	○	×	○	
			1 (01H)	Modulation	0 – 127 (00H...7FH)	Data	○	○	○ (All manually played parts)	○ (Modulation Wheel)	○	×	○	
			5 (05H)	Portamento Time	0 – 127 (00H...7FH)	Data	○	○	○ (All manually played parts)	×	○	×	×	
			6 (06H)	Data Entry MSB	0 – 127 (00H...7FH)	Data	○	○	○ (All manually played parts)	○ (VOICE EDIT)	○	×	○	
			7 (07H)	Main Volume	0 – 127 (00H...7FH)	Data	○	○	○ (All manually played parts)	○ (VOICE EDIT)	○	×	○	
			10 (0AH)	Panpot	0 – 127 (00H...7FH)	L64	○	○	○ (All manually played parts)	○ (VOICE EDIT)	○	×	○	
			11 (0BH)	Expression	0 – 127 (00H...7FH)	Data	○	○	○ (All manually played parts)	○ (Pedal1 – 4, Modulation Wheel)	○	×	○	
			32 (20H)	Bank Select LSB	0 – 127 (00H...7FH)	Data	○	○	×	○ (Voice)	○	×	○	
			38 (26H)	Data Entry LSB	0 – 127 (00H...7FH)	Data	○	○	○ (All manually played parts)	○ (VOICE EDIT)	○	×	○	
			64 (40H)	Sustain (Damper)	0 – 127 (00H...7FH)	Data	○	○	○ (All manually played parts)	○ (Pedal1 – 4)	○	×	○	
			65 (41H)	Portamento	0 – 127 (00H...7FH)	0...63, 64...127 (OFF, ON)	○	○	○ (All manually played parts)	×	○	×	×	
			66 (42H)	Sostenuto	0 – 127 (00H...7FH)	0...63, 64...127 (OFF, ON)	○	○	○ (All manually played parts)	○ (Pedal1 – 4)	○	×	○	
			67 (43H)	Soft Pedal	0 – 127 (00H...7FH)	0...63, 64...127 (OFF, ON)	○	○	○ (All manually played parts)	○ (Pedal1 – 4)	○	×	○	
			71 (47H)	Harmonic Content	0 – 127 (00H...7FH)	-64...0...+63	○	○	○ (All manually played parts)	○ (Pedal4, Modulation Wheel, VOICE EDIT)	○	×	○	
			72 (48H)	Release Time	0 – 127 (00H...7FH)	-64...0...+63	○	○	○ (All manually played parts)	×	○	×	×	
			73 (49H)	Attack Time	0 – 127 (00H...7FH)	-64...0...+63	○	○	○ (All manually played parts)	×	○	×	×	
			74 (4AH)	Brightness	0 – 127 (00H...7FH)	-64...0...+63	○	○	○ (All manually played parts)	○ (Pedal4, Modulation Wheel, VOICE EDIT)	○	×	○	
			84 (54H)	Portamento Control	0 – 127 (00H...7FH)	Key no. (0 – 127)	○	○	×	×	○	×	×	
			91 (5BH)	Effect1 Depth (Reverb Send Level)	0 – 127 (00H...7FH)	Data	○	○	○ (All manually played parts)	○ (Pedal4, Modulation Wheel, VOICE EDIT)	○	×	○	
			93 (5DH)	Effect3 Depth (Chorus Send Level)	0 – 127 (00H...7FH)	Data	○	○	○ (All manually played parts)	○ (Pedal4, Modulation Wheel, VOICE EDIT)	○	×	○	
			94 (5EH)	Effect4 Depth (Variation Send Level)	0 – 127 (00H...7FH)	Data	○	×	×	×	○	×	×	
			96 (60H)	RPN Increment	-	-	The data byte is ignored.	○	○	×	×	○	×	×
			97 (61H)	RPN Decrement	-	-	The data byte is ignored.	○	○	×	×	○	×	×
			98 (62H)	NRPN LSB	0 – 127 (00H...7FH)	Data	○	○	×	×	○	×	×	
			99 (63H)	NRPN MSB	0 – 127 (00H...7FH)	Data	○	○	×	×	○	×	×	
			100 (64H)	RPN LSB	0 – 127 (00H...7FH)	Data	○	○	○ (All manually played parts)	○ (VOICE EDIT)	○	×	○	
101 (65H)	RPN MSB	0 – 127 (00H...7FH)	Data	○	○	○ (All manually played parts)	○ (VOICE EDIT)	○	×	○				
		0 – 119 (00H...77H)	(Assignable)	0 – 127 (00H...7FH)	Data	×	×	×	○ (Pedal4, Modulation Wheel)	×	×	×		
Mode Message	BnH	(n: Channel Number)	120 (78H)	All Sound Off	0 (00H)	Data	○	○	○ (All manually played parts)	×	○	×	×	
			121 (79H)	Reset All Controllers	0 (00H)	Data	○	×	×	×	○	×	×	
			123 (7BH)	All Note Off	0 (00H)	Data	○	○	○ (All manually played parts)	×	○	×	×	
			124 (7CH)	Omni Off	0 (00H)	Data	○	×	×	×	×	×	×	
			125 (7DH)	Omni On	0 (00H)	Data	○	×	×	×	×	×	×	
			126 (7EH)	Mono	0 – 16 (00H...10H)	Data	○	×	×	×	×	×	×	
127 (7FH)	Poly	0 (00H)	Data	○	×	×	×	×	○	×	×			
Program Change	CnH	(n: Channel Number)	pp (00H...7FH)	Voice number (0 – 127)	-	-	○	○	×	○ (Voice)	○	×	○	



MIDI Events	Status byte		1st Data byte		2nd Data byte		MIDI Reception (respond/ignore)			MIDI Transmission (generated data)			REC
	Status	Data (HEX)	Parameter	Data (HEX)	Parameter	Song	Main Layer Left Layer	Keyboard	Panel (main generation method)	Song	Midi	Recorded from panel	
Channel After Touch	DnH	(n: Channel Number)	vv (00H...7FH)	Data	- -	-	○	○	○ (All manually played parts)	○ (Pedal4, Modulation Wheel)	○	×	×
Polyphonic After Touch	AnH	(n: Channel Number)	kk (00H...7FH)	Key no. (0 - 127)	vv (00H...7FH)	Data	○	×	×	×	○	×	×
Pitch Bend Change	EnH	(n: Channel Number)	cc (00H...7FH)	LSB	dd (00H...7FH)	MSB	○	○	○ (All manually played parts)	○ (Pitch Bend Wheel)	○	×	○
Realtime Message	F8H	MIDI Clock	-	-	-	-		×	×	○	×	×	
	FAH	Start	-	-	-	-		×	×	×		×	
	FBH	Continue	-	-	-	-		×	×	×		×	
	FCH	Stop	-	-	-	-		×	×	×		×	
	FEH	Active Sense	-	-	-	-		○	○	○		×	
	FFH	System Reset	-	-	-	-		×	×	×		×	

## MIDI CHANNEL MESSAGE (2)

Parameters controlled by NRPN (Non-Registered Parameter Numbers)

NRPN		Data Entry		Parameter	Data Range	MIDI Reception (respond/ignore)			MIDI Transmission (generated data)			REC
MSB	LSB	MSB	LSB			Song	Main Layer Left Layer	Keyboard	Panel (main generation method)	Song	Midi	Recorded from panel
01H	08H	mmH	-	Vibrato Rate	mm: 00H-40H-7FH (-64...0...+63)	○	○	×	×	○	×	×
01H	09H	mmH	-	Vibrato Depth	mm: 00H-40H-7FH (-64...0...+63)	○	○	×	×	○	×	×
01H	0AH	mmH	-	Vibrato Delay	mm: 00H-40H-7FH (-64...0...+63)	○	○	×	×	○	×	×
01H	20H	mmH	-	Low Pass Filter Cutoff Frequency	mm: 00H-40H-7FH (-64...0...+63)	○	×	×	×	○	×	×
01H	21H	mmH	-	Low Pass Filter Resonance	mm: 00H-40H-7FH (-64...0...+63)	○	×	×	×	○	×	×
01H	30H	mmH	-	EQ BASS	mm: 00H-40H-7FH (-64...0...+63)	○	×	×	×	○	×	×
01H	31H	mmH	-	EQ TREBLE	mm: 00H-40H-7FH (-64...0...+63)	○	×	×	×	○	×	×
01H	34H	mmH	-	EQ BASS Frequency	mm: 04H-28H (32...2.0k[Hz])	○	×	×	×	○	×	×
01H	35H	mmH	-	EQ TREBLE Frequency	mm: 1CH-3AH (500...16.0k[Hz])	○	×	×	×	○	×	×
01H	63H	mmH	-	EG Attack Time	mm: 00H-40H-7FH (-64...0...+63)	○	×	×	×	○	×	×
01H	64H	mmH	-	EG Decay Time	mm: 00H-40H-7FH (-64...0...+63)	○	○	×	×	○	×	×
01H	66H	mmH	-	EG Release	mm: 00H-40H-7FH (-64...0...+63)	○	×	×	×	○	×	×
14H	rrH	mmH	-	Drum Low Pass Filter Cutoff Frequency	rr: drum instrument note number mm: 00H-40H-7FH (-64...0...+63)	○	×	×	×	○	×	×
15H	rrH	mmH	-	Drum Low Pass Filter Resonance	rr: drum instrument note number mm: 00H-40H-7FH (-64...0...+63)	○	×	×	×	○	×	×
16H	rrH	mmH	-	Drum EG Attack Rate	rr: drum instrument note number mm: 00H-40H-7FH (-64...0...+63)	○	×	×	×	○	×	×
17H	rrH	mmH	-	Drum EG Decay Rate	rr: drum instrument note number mm: 00H-40H-7FH (-64...0...+63)	○	×	×	×	○	×	×
18H	rrH	mmH	-	Drum Pitch Coarse	rr: drum instrument note number mm: 00H-40H-7FH (-64...0...+63)	○	×	×	×	○	×	×
19H	rrH	mmH	-	Drum Pitch Fine	rr: drum instrument note number mm: 00H-40H-7FH (-64...0...+63)	○	×	×	×	○	×	×
1AH	rrH	mmH	-	Drum Level	rr: drum instrument note number mm: 00H-7FH (0...127)	○	×	×	×	○	×	×
1CH	rrH	mmH	-	Drum Pan	rr: drum instrument note number mm: 00H, 01H-40H-7FH (RND, L63...C...R63)	○	×	×	×	○	×	×
1DH	rrH	mmH	-	Drum Reverb Send Level	rr: drum instrument note number mm: 00H-7FH (0...127)	○	×	×	×	○	×	×
1EH	rrH	mmH	-	Drum Chorus Send Level	rr: drum instrument note number mm: 00H-7FH (0...127)	○	×	×	×	○	×	×
1FH	rrH	mmH	-	Drum Variation Send Level	rr: drum instrument note number mm: 00H-7FH (0...127) (Variation Connection = SYSTEM) mm: 00H, 01H-7FH (OFF, ON) (Variation Connection = INSERTION)	○	×	×	×	○	×	×

NRPN MSB: 14H-1FH (for drums) message is accepted as long as the channel is set with a drum Voice.  
Data Entry LSB: Ignored.

Parameters controlled by RPN (Registered Parameter Numbers)

RPN		Data Entry		Parameter	Data Range	MIDI Reception (respond/ignore)			MIDI Transmission (generated data)			REC
MSB	LSB	MSB	LSB			Song	Main Layer Left Layer	Keyboard	Panel (main generation method)	Song	Midi	Recorded from panel
00H	00H	mmH	-	Pitch Bend Sensitivity	mm: 00H-18H (0...+24[semitones])	○	○	○ (All manually played parts)	○ (Other Setting)	○	×	○
00H	01H	mmH	llH	Fine Tune	mm I: 00H 00H -100 [cent] ... mm II: 40H 00H 0 [cent] ... mm II: 7FH 7FH 100 [cent]	○	○	○ (All manually played parts)	○ (VOICE EDIT)	○	×	○
00H	02H	mmH	-	Coarse Tune	mm: 28H-40H-58H (-24...0...+24 [semitones])	○	○	○ (All manually played parts)	×	○	×	×
7FH	7FH	-	-	Null	-	○	○	○ (All manually played parts)	×	○	×	×

## MIDI PARAMETER CHANGE TABLE

\*Not Received when Receive Parameter SysEx is set to off.  
 \*Not transmitted when Transmit Parameter SysEx is set to off.

MIDI Parameter Change table (XG SYSTEM)

Address (H)	Size (H)	Data (H)	Parameter	Description	XG Default (H)	MIDI Reception (respond/ignore)			MIDI Transmission (generated data)			REC Recorded from panel			
						Song	Main Layer Left Layer	Keyboard	Panel (main generation method)	Song	Midi				
00	00	00 01 02 03	4	00-0F 00-0F 00-0F 00-0F	MASTER TUNE	-102.4...0...+102.3 [cent] 1st bit 3-0 → bit 15-12 2nd bit 3-0 → bit 11-8 3rd bit 3-0 → bit 7-4 4th bit 3-0 → bit 3-0	*Panel setting value		○		×	○	×	×	
		04	1	00-7F	MASTER VOLUME	0...127	7F	○	×	×	×	×	○	×	×
		05	1	00-7F	MASTER ATTENUATOR	0...127	00	×	×	×	×	×	×	×	×
		06	1	28-58	TRANSPOSE	-24...0...+24 [semitones]	40	○	×	×	×	×	○	×	×
		7D	1	N	DRUM SETUP RESET	N: Drum setup number	-	○	×	×	×	×	○	×	×
		7E	1	00	XG SYSTEM ON	00=XG system ON	-	○	×	×	×	×	○	×	○
		7F	1	00	ALL PARAMETER RESET	00=ON	-	○	×	×	×	×	○	×	×

TOTAL SIZE 07

MIDI Parameter Change table (SYSTEM INFORMATION)

Address (H)	Size (H)	Data (H)	Parameter	Description	MIDI Reception (respond/ignore)			MIDI Transmission (generated data)			REC Recorded from panel		
					Song	Main Layer Left Layer	Keyboard	Panel (main generation method)	Song	Midi			
01	00	00 ... 0D	E	20-7F ... 20-7F	Model Name 1 ... Model Name 14	32...127 (ASCII CHARACTER) ... 32...127 (ASCII CHARACTER)	-	-	-	×	×	○	×
		0E	1		NOT USED								
		0F	1		NOT USED								

TOTAL SIZE 10

Transmitted in response to Dump Request. Not received.

MIDI Parameter Change table (EFFECT1)

Address (H)	Size (H)	Data (H)	Parameter	Description	XG Default (H)	MIDI Reception (respond/ignore)			MIDI Transmission (generated data)			REC Recorded from panel	
						Song	Main Layer Left Layer	Keyboard	Panel (main generation method)	Song	Midi		
02	01	00	2	00-7F 00-7F	REVERB TYPE MSB REVERB TYPE LSB	Refer to Effect Parameter List :	01 (=HALL1) 00		○		○	×	○
		02	1	00-7F	REVERB PARAMETER 1	:	Depends on Reverb type	○	×	×	×	○	×
		03	1	00-7F	REVERB PARAMETER 2	:	Depends on Reverb type	○	×	×	×	○	×
		04	1	00-7F	REVERB PARAMETER 3	:	Depends on Reverb type	○	×	×	×	○	×
		05	1	00-7F	REVERB PARAMETER 4	:	Depends on Reverb type	○	×	×	×	○	×
		06	1	00-7F	REVERB PARAMETER 5	:	Depends on Reverb type	○	×	×	×	○	×
		07	1	00-7F	REVERB PARAMETER 6	:	Depends on Reverb type	○	×	×	×	○	×
		08	1	00-7F	REVERB PARAMETER 7	:	Depends on Reverb type	○	×	×	×	○	×
		09	1	00-7F	REVERB PARAMETER 8	:	Depends on Reverb type	○	×	×	×	○	×
		0A	1	00-7F	REVERB PARAMETER 9	:	Depends on Reverb type	○	×	×	×	○	×
		0B	1	00-7F	REVERB PARAMETER 10	:	Depends on Reverb type	○	×	×	×	○	×
		0C	1	00-7F	REVERB RETURN	--dB...0dB...+6dB (0...64...127)	40		○	×	×	○	×
		0D	1	01-7F	REVERB PAN	L63...C...R63	40		○	×	×	○	×

TOTAL SIZE 0E

02	01	10	1	00-7F	REVERB PARAMETER 11	Refer to Effect Parameter List	Depends on Reverb type	○	×	×	×	○	×
		11	1	00-7F	REVERB PARAMETER 12	:	Depends on Reverb type	○	×	×	×	○	×
		12	1	00-7F	REVERB PARAMETER 13	:	Depends on Reverb type	○	×	×	×	○	×
		13	1	00-7F	REVERB PARAMETER 14	:	Depends on Reverb type	○	×	×	×	○	×
		14	1	00-7F	REVERB PARAMETER 15	:	Depends on Reverb type	○	×	×	×	○	×
		15	1	00-7F	REVERB PARAMETER 16	:	Depends on Reverb type	○	×	×	×	○	×

TOTAL SIZE 06

Address (H)	Size (H)	Data (H)	Parameter	Description	XG Default (H)	MIDI Reception (respond/ignore)			MIDI Transmission (generated data)			REC Recorded from panel
						Song	Main Layer Left Left Layer	Keyboard	Panel (main generation method)	Song	Midi	
02 01 20	2	00-7F 00-7F	CHORUS TYPE MSB CHORUS TYPE LSB	Refer to Effect Parameter List	41 (=CHORUS1) 00				○ (VOICE EDIT)	○	×	○
	22	1 00-7F	CHORUS PARAMETER 1	:	Depends on Chorus Type	○ (*Depends on Chorus Type)			×	○	×	×
	23	1 00-7F	CHORUS PARAMETER 2	:	Depends on Chorus Type	○ (*Depends on Chorus Type)			×	○	×	×
	24	1 00-7F	CHORUS PARAMETER 3	:	Depends on Chorus Type	○ (*Depends on Chorus Type)			×	○	×	×
	25	1 00-7F	CHORUS PARAMETER 4	:	Depends on Chorus Type	○ (*Depends on Chorus Type)			×	○	×	×
	26	1 00-7F	CHORUS PARAMETER 5	:	Depends on Chorus Type	○ (*Depends on Chorus Type)			×	○	×	×
	27	1 00-7F	CHORUS PARAMETER 6	:	Depends on Chorus Type	○ (*Depends on Chorus Type)			×	○	×	×
	28	1 00-7F	CHORUS PARAMETER 7	:	Depends on Chorus Type	○ (*Depends on Chorus Type)			×	○	×	×
	29	1 00-7F	CHORUS PARAMETER 8	:	Depends on Chorus Type	○ (*Depends on Chorus Type)			×	○	×	×
	2A	1 00-7F	CHORUS PARAMETER 9	:	Depends on Chorus Type	○ (*Depends on Chorus Type)			×	○	×	×
	2B	1 00-7F	CHORUS PARAMETER 10	:	Depends on Chorus Type	○ (*Depends on Chorus Type)			×	○	×	×
	2C	1 00-7F	CHORUS RETURN	---dB...0dB...+6dB (0...64...127)	40	○			×	○	×	×
	2D	1 01-7F	CHORUS PAN	L63...C...R63	40	○			×	○	×	×
	2E	1 00-7F	SEND CHORUS TO REVERB	---dB...0dB...+6dB (0...64...127)	00	○			×	○	×	×

TOTAL SIZE 0F

	02 01 30	1	00-7F	CHORUS PARAMETER 11	Refer to Effect Parameter List	Depends on Chorus Type	○ (*Depends on Chorus Type)			×	○	×	×
		31	1 00-7F	CHORUS PARAMETER 12	:	Depends on Chorus Type	○ (*Depends on Chorus Type)			×	○	×	×
		32	1 00-7F	CHORUS PARAMETER 13	:	Depends on Chorus Type	○ (*Depends on Chorus Type)			×	○	×	×
		33	1 00-7F	CHORUS PARAMETER 14	:	Depends on Chorus Type	○ (*Depends on Chorus Type)			×	○	×	×
		34	1 00-7F	CHORUS PARAMETER 15	:	Depends on Chorus Type	○ (*Depends on Chorus Type)			×	○	×	×
		35	1 00-7F	CHORUS PARAMETER 16	:	Depends on Chorus Type	○ (*Depends on Chorus Type)			×	○	×	×

TOTAL SIZE 06

Address (H)	Size (H)	Data (H)	Parameter	Description	XG Default (H)	MIDI Reception (respond/ignore)			MIDI Transmission (generated data)			REC Recorded from panel	
						Song	Main Layer Left Left Layer	Keyboard	Panel (main generation method)	Song	Midi		
02 01 40	2	00-7F 00-7F	VARIATION TYPE MSB VARIATION TYPE LSB	Refer to Effect Parameter List	05 (=DELAY L, C, R) 00				○	×	○	×	×
	42	2 00-7F 00-7F	VARIATION PARAMETER 1 MSB VARIATION PARAMETER 1 LSB	:	Depends on Variation Type	○ (*Depends on Variation Type)			×	○	×	×	
	44	2 00-7F 00-7F	VARIATION PARAMETER 2 MSB VARIATION PARAMETER 2 LSB	:	Depends on Variation Type	○ (*Depends on Variation Type)			×	○	×	×	
	46	2 00-7F 00-7F	VARIATION PARAMETER 3 MSB VARIATION PARAMETER 3 LSB	:	Depends on Variation Type	○ (*Depends on Variation Type)			×	○	×	×	
	48	2 00-7F 00-7F	VARIATION PARAMETER 4 MSB VARIATION PARAMETER 4 LSB	:	Depends on Variation Type	○ (*Depends on Variation Type)			×	○	×	×	
	4A	2 00-7F 00-7F	VARIATION PARAMETER 5 MSB VARIATION PARAMETER 5 LSB	:	Depends on Variation Type	○ (*Depends on Variation Type)			×	○	×	×	
	4C	2 00-7F 00-7F	VARIATION PARAMETER 6 MSB VARIATION PARAMETER 6 LSB	:	Depends on Variation Type	○ (*Depends on Variation Type)			×	○	×	×	
	4E	2 00-7F 00-7F	VARIATION PARAMETER 7 MSB VARIATION PARAMETER 7 LSB	:	Depends on Variation Type	○ (*Depends on Variation Type)			×	○	×	×	
	50	2 00-7F 00-7F	VARIATION PARAMETER 8 MSB VARIATION PARAMETER 8 LSB	:	Depends on Variation Type	○ (*Depends on Variation Type)			×	○	×	×	
	52	2 00-7F 00-7F	VARIATION PARAMETER 9 MSB VARIATION PARAMETER 9 LSB	:	Depends on Variation Type	○ (*Depends on Variation Type)			×	○	×	×	
	54	2 00-7F 00-7F	VARIATION PARAMETER 10 MSB VARIATION PARAMETER 10 LSB	:	Depends on Variation Type	○ (*Depends on Variation Type)			×	○	×	×	
	56	1 00-7F	VARIATION RETURN	---dB...0dB...+6dB (0...64...127)	40	○			×	○	×	×	
	57	1 01-7F	VARIATION PAN	L63...C...R63	40	○			×	○	×	×	
	58	1 00-7F	SEND VARIATION TO REVERB	---dB...0dB...+6dB (0...64...127)	00	○			×	○	×	×	
	59	1 00-7F	SEND VARIATION TO CHORUS	---dB...0dB...+6dB (0...64...127)	00	○			×	○	×	×	
	5A	1 00-01	VARIATION CONNECTION	INSERTION, SYSTEM	00	○			×	○	×	×	
	5B	1 00-7F	VARIATION PART NUMBER	Reception: Part1...16 (0...15) Transmission: Part1...16 (0...15) OFF (127)	7F	○			×	○	×	×	
	5C	1 00-7F	MW VARIATION CONTROL DEPTH	-64...0...+63	40	○			×	○	×	×	
	5D	1 00-7F	BEND VARIATION CONTROL DEPTH	-64...0...+63	40	○			×	○	×	×	
	5E	1 00-7F	CAT VARIATION CONTROL DEPTH	-64...0...+63	40	○			×	○	×	×	
	5F	1 00-7F	AC1 VARIATION CONTROL DEPTH	-64...0...+63	40	○			×	○	×	×	
	60	1 00-7F	AC2 VARIATION CONTROL DEPTH	-64...0...+63	40	○			×	○	×	×	

TOTAL SIZE 21

	02 01 70	1	00-7F	VARIATION PARAMETER 11	Refer to Effect Parameter List	Depends on Variation Type	○ (*Depends on Variation Type)			×	○	×	×
		71	1 00-7F	VARIATION PARAMETER 12	:	Depends on Variation Type	○ (*Depends on Variation Type)			×	○	×	×
		72	1 00-7F	VARIATION PARAMETER 13	:	Depends on Variation Type	○ (*Depends on Variation Type)			×	○	×	×
		73	1 00-7F	VARIATION PARAMETER 14	:	Depends on Variation Type	○ (*Depends on Variation Type)			×	○	×	×
		74	1 00-7F	VARIATION PARAMETER 15	:	Depends on Variation Type	○ (*Depends on Variation Type)			×	○	×	×
		75	1 00-7F	VARIATION PARAMETER 16	:	Depends on Variation Type	○ (*Depends on Variation Type)			×	○	×	×

TOTAL SIZE 06

MIDI Data Format

MIDI Parameter Change table (MULTI EQ)

Address (H)	Size (H)	Data (H)	Parameter	Description		MIDI Reception (respond/ignore)			MIDI Transmission (generated data)		REC	
						Song	Main Layer Left Layer	Keyboard	Panel (main generation method)	Song	Midi	Recorded from panel
02	40	00	1	00-04	EQ TYPE	flat, jazz, pops, rock, classic						
		01	1	34-4C	EQ GAIN 1	-12...0...+12 [dB]						
		02	1	04-28	EQ FREQUENCY 1	32...2.0k [Hz]						
		03	1	01-78	EQ Q 1	0.1...12.0						
		04	1	00-01	EQ SHAPE 1	shelving, peaking						
		05	1	34-4C	EQ GAIN 2	-12...0...+12 [dB]						
		06	1	0E-36	EQ FREQUENCY 2	100...10.0k [Hz]						
		07	1	01-78	EQ Q 2	0.1...12.0						
		08	1		NOT USED							
		09	1	34-4C	EQ GAIN 3	-12...0...+12 [dB]						
		0A	1	0E-36	EQ FREQUENCY 3	100...10.0k [Hz]						
		0B	1	01-78	EQ Q 3	0.1...12.0						
		0C	1		NOT USED							
		0D	1	34-4C	EQ GAIN4	-12...0...+12 [dB]						
		0E	1	0E-36	EQ FREQUENCY 4	100...10.0k [Hz]						
		0F	1	01-78	EQ Q 4	0.1...12.0						
		10	1		NOT USED							
		11	1	34-4C	EQ GAIN 5	-12...0...+12 [dB]						
		12	1	1C-3A	EQ FREQUENCY 5	0.5k...16.0k [Hz]						
		13	1	01-78	EQ Q 5	0.1...12.0						
		14	1	00-01	EQ SHAPE 5	shelving, peaking						

TOTAL SIZE 15

\*MULTI EQ is not reset by the XG System On.

MIDI Parameter Change table (EFFECT2)

Address (H)	Size (H)	Data (H)	Parameter	Description		MIDI Reception (respond/ignore)			MIDI Transmission (generated data)		REC	
						Song	Main Layer Left Layer	Keyboard	Panel (main generation method)	Song	Midi	Recorded from panel
03	n	00	2	00-7F 00-7F	INSERTION EFFECT TYPE MSB INSERTION EFFECT TYPE LSB	Refer to Effect Parameter List						
		02	1	00-7F	INSERTION EFFECT PARAMETER 1	:						
		03	1	00-7F	INSERTION EFFECT PARAMETER 2	:						
		04	1	00-7F	INSERTION EFFECT PARAMETER 3	:						
		05	1	00-7F	INSERTION EFFECT PARAMETER 4	:						
		06	1	00-7F	INSERTION EFFECT PARAMETER 5	:						
		07	1	00-7F	INSERTION EFFECT PARAMETER 6	:						
		08	1	00-7F	INSERTION EFFECT PARAMETER 7	:						
		09	1	00-7F	INSERTION EFFECT PARAMETER 8	:						
		0A	1	00-7F	INSERTION EFFECT PARAMETER 9	:						
		0B	1	00-7F	INSERTION EFFECT PARAMETER 10	:						
		0C	1	00-7F	INSERTION EFFECT PART NUMBER	Reception: Part1...16 (0...15) Transmission: Part1...16 (0...15) OFF (127)						
		0D	1	00-7F	MW INSERTION CONTROL DEPTH	-64...0...+63						
		0E	1	00-7F	BEND INSERTION CONTROL DEPTH	-64...0...+63						
		0F	1	00-7F	CAT INSERTION CONTROL DEPTH	-64...0...+63						
		10	1	00-7F	AC1 INSERTION CONTROL DEPTH	-64...0...+63						
		11	1	00-7F	AC2 INSERTION CONTROL DEPTH	-64...0...+63						

TOTAL SIZE 12

		20	1	00-7F	INSERTION EFFECT PARAMETER 11	Refer to Effect Parameter List						
		21	1	00-7F	INSERTION EFFECT PARAMETER 12	:						
		22	1	00-7F	INSERTION EFFECT PARAMETER 13	:						
		23	1	00-7F	INSERTION EFFECT PARAMETER 14	:						
		24	1	00-7F	INSERTION EFFECT PARAMETER 15	:						
		25	1	00-7F	INSERTION EFFECT PARAMETER 16	:						

TOTAL SIZE 6

		30	2	00-7F 00-7F	INSERTION EFFECT PARAMETER 1 MSB INSERTION EFFECT PARAMETER 1 LSB	Refer to Effect Parameter List						
		32	2	00-7F 00-7F	INSERTION EFFECT PARAMETER 2 MSB INSERTION EFFECT PARAMETER 2 LSB	:						
		34	2	00-7F 00-7F	INSERTION EFFECT PARAMETER 3 MSB INSERTION EFFECT PARAMETER 3 LSB	:						
		36	2	00-7F 00-7F	INSERTION EFFECT PARAMETER 4 MSB INSERTION EFFECT PARAMETER 4 LSB	:						
		38	2	00-7F 00-7F	INSERTION EFFECT PARAMETER 5 MSB INSERTION EFFECT PARAMETER 5 LSB	:						
		3A	2	00-7F 00-7F	INSERTION EFFECT PARAMETER 6 MSB INSERTION EFFECT PARAMETER 6 LSB	:						
		3C	2	00-7F 00-7F	INSERTION EFFECT PARAMETER 7 MSB INSERTION EFFECT PARAMETER 7 LSB	:						
		3E	2	00-7F 00-7F	INSERTION EFFECT PARAMETER 8 MSB INSERTION EFFECT PARAMETER 8 LSB	:						

	40	2	00-7F 00-7F	INSERTION EFFECT PARAMETER 9 MSB INSERTION EFFECT PARAMETER 9 LSB	:	:	○ (*Depends on Insertion Type)	×	○	×	×
	42	2	00-7F 00-7F	INSERTION EFFECT PARAMETER 10 MSB INSERTION EFFECT PARAMETER 10 LSB	:	:	○ (*Depends on Insertion Type)	○ (VOICE EDIT)	○	×	○

TOTAL SIZE 14

The EFFECT2 Parameter cannot be reset to its factory setting with XG SYSTEM ON.

The second byte of the address is considered as an Insertion effect number.

n: insertion effect number (n = 0 – 2)

For effect types that do not require MSB, the Parameters for Address 02 – 0B will be received and the Parameters for Address 30 – 42 will not be received.

For effect types that require MSB, the Parameters for Address 30 – 42 will be received and the Parameters for Address 02 – 0B will not be received.

When Bulk Dumps that include Effect Type data are transmitted, the Parameters for Address 02-0B will always be transmitted. But, effects that require MSB, when the bulk dump is received the Parameters for Address 02 – 0B will not be received.

### MIDI Parameter Change table (MULTI PART)

Address (H)	Size (H)	Data (H)	Parameter	Description	XG Default (H)	MIDI Reception (respond/ignore)			MIDI Transmission (generated data)			REC Recorded from panel		
						Song	Main Layer Left Layer	Keyboard	Panel (main generation method)	Song	Midi			
08	nn	00	1	00-20	NOT USED		×	×	×	×	×	×		
		01	1	00-7F	BANK SELECT MSB	0...127	part10=7F, other parts=00	○	○	×	×	○	×	×
		02	1	00-7F	BANK SELECT LSB	0...127	00	○	○	×	×	○	×	×
		03	1	00-7F	PROGRAM NUMBER	1...128	00	○	○	×	×	○	×	×
		04	1	00-0F, 7F	Rcv CHANNEL	1...16, OFF	Part No.	○	×	×	×	○	×	×
		05	1	00-01	MONO/POLY MODE	MONO, POLY	01	○	×	×	×	○	×	×
		06	1	00-02	SAME NOTE NUMBER KEY ON ASSIGN	SINGLE, MULTI, INST (for Drum)	01	○	×	×	×	○	×	×
		07	1	00-03	PART MODE	NORMAL, DRUM, DRUMS1...2	part10=02, other parts=00	○	×	×	○ (Drum Voice)	○	×	○
		08	1	28-58	NOTE SHIFT	-24...0...+24 [semitones]	40	○	○	×	×	○	×	×
		09 0A	2	00-0F 00-0F	DETUNE	-12.8...0...+12.7 [Hz] 1st bit3-0 → bit7-4 2nd bit3-0 → bit3-0	08 00	○	○	×	×	○	×	×
		0B	1	00-7F	VOLUME	0...127	64	○	○	×	×	○	×	×
		0C	1	00-7F	VELOCITY SENSE DEPTH	0...127	40	○	○	×	○ (VOICE EDIT)	○	×	○
		0D	1	00-7F	VELOCITY SENSE OFFSET	0...127	40	○	○	×	○ (VOICE EDIT)	○	×	○
		0E	1	00-7F	PAN	RND, L63...C...R63	40	○	○	×	×	○	×	×
		0F	1	00-7F	NOTE LIMIT LOW	C-2...G8	00	○	○	×	×	○	×	×
		10	1	00-7F	NOTE LIMIT HIGH	C-2...G8	7F	○	○	×	×	○	×	×
		11	1	00-7F	DRY LEVEL	0...127	7F	○	○	×	×	○	×	×
		12	1	00-7F	CHORUS SEND	0...127	00	○	○	×	×	○	×	×
		13	1	00-7F	REVERB SEND	0...127	28	○	○	×	×	○	×	×
		14	1	00-7F	VARIATION SEND	0...127	00	○	○	×	×	○	×	×
		15	1	00-7F	VIBRATO RATE	-64...0...+63	40	○	○	×	×	○	×	×
		16	1	00-7F	VIBRATO DEPTH	-64...0...+63	40	○	○	×	×	○	×	×
		17	1	00-7F	VIBRATO DELAY	-64...0...+63	40	○	○	×	×	○	×	×
		18	1	00-7F	FILTER CUTOFF FREQUENCY	-64...0...+63	40	○	○	×	×	○	×	×
		19	1	00-7F	FILTER RESONANCE	-64...0...+63	40	○	○	×	×	○	×	×
		1A	1	00-7F	EG ATTACK TIME	-64...0...+63	40	○	○	×	×	○	×	×
		1B	1	00-7F	EG DECAY TIME	-64...0...+63	40	○	○	×	×	○	×	×
		1C	1	00-7F	EG RELEASE TIME	-64...0...+63	40	○	○	×	×	○	×	×
		1D	1	28-58	MW PITCH CONTROL	-24...0...+24 [semitones]	40	○	○	×	×	○	×	×
		1E	1	00-7F	MW LOW PASS FILTER CONTROL	-9600...0...+9450 [cent]	40	○	○	×	×	○	×	×
		1F	1	00-7F	MW AMPLITUDE CONTROL	-100...0...+100 [%]	40	○	○	×	×	○	×	×
		20	1	00-7F	MW LFO PMOD DEPTH	0...127	0A	○	○	×	×	○	×	×
		21	1	00-7F	MW LFO FMOD DEPTH	0...127	00	○	○	×	×	○	×	×
		22	1	00-7F	MW LFO AMOD DEPTH	0...127	00	○	○	×	×	○	×	×
		23	1	28-58	BEND PITCH CONTROL	-24...0...+24 [semitones]	42	○	○	×	×	○	×	×
		24	1	00-7F	BEND LOW PASS FILTER CONTROL	-9600...0...+9450 [cent]	40	○	○	×	×	○	×	×
		25	1	00-7F	BEND AMPLITUDE CONTROL	-100...0...+100 [%]	40	○	○	×	×	○	×	×
		26	1	00-7F	BEND LFO PMOD DEPTH	0...127	00	○	○	×	×	○	×	×
		27	1	00-7F	BEND LFO FMOD DEPTH	0...127	00	○	○	×	×	○	×	×
		28	1	00-7F	BEND LFO AMOD DEPTH	0...127	00	○	○	×	×	○	×	×

TOTAL SIZE 29

Address (H)	Size (H)	Data (H)	Parameter	Description	XG Default (H)	MIDI Reception (respond/ignore)			MIDI Transmission (generated data)			REC Recorded from panel		
						Song	Main Layer Left Layer	Keyboard	Panel (main generation method)	Song	Midi			
		30	1	00-01	Rcv PITCH BEND	OFF, ON	01	○	×	×	×	○	×	×
		31	1	00-01	Rcv CH AFTER TOUCH (CAT)	OFF, ON	01	○	×	×	×	○	×	×
		32	1	00-01	Rcv PROGRAM CHANGE	OFF, ON	01	○	×	×	×	○	×	×
		33	1	00-01	Rcv CONTROL CHANGE	OFF, ON	01	○	×	×	×	○	×	×
		34	1	00-01	Rcv POLY AFTER TOUCH (PAT)	OFF, ON	01	○	×	×	×	○	×	×
		35	1	00-01	Rcv NOTE MESSAGE	OFF, ON	01	○	×	×	×	○	×	×
		36	1	00-01	Rcv RPN	OFF, ON	01	○	×	×	×	○	×	×
		37	1	00-01	Rcv NRPN	OFF, ON	XGmode=01, GMmode=00	○	×	×	×	○	×	×
		38	1	00-01	Rcv MODULATION	OFF, ON	01	○	×	×	×	○	×	×
		39	1	00-01	Rcv VOLUME	OFF, ON	01	○	×	×	×	○	×	×
		3A	1	00-01	Rcv PAN	OFF, ON	01	○	×	×	×	○	×	×
		3B	1	00-01	Rcv EXPRESSION	OFF, ON	01	○	×	×	×	○	×	×
		3C	1	00-01	Rcv HOLD1	OFF, ON	01	○	×	×	×	○	×	×
		3D	1	00-01	Rcv PORTAMENTO	OFF, ON	01	○	×	×	×	○	×	×
		3E	1	00-01	Rcv SOSTENUTO	OFF, ON	01	○	×	×	×	○	×	×
		3F	1	00-01	Rcv SOFT PEDAL	OFF, ON	01	○	×	×	×	○	×	×
		40	1	00-01	Rcv BANK SELECT	OFF, ON	01	○	×	×	×	○	×	×
		41	1	00-7F	SCALE TUNING C	-63...0...+63 [cent]	40	○	○	×	○ (Other Setting)	○	×	○

MIDI Data Format

Address (H)	Size (H)	Data (H)	Parameter	Description	XG Default (H)	MIDI Reception (respond/ignore)			MIDI Transmission (generated data)			REC Recorded from panel	
						Song	Main Layer Left Layer	Keyboard	Panel (main generation method)	Song	Midi		
	42	1	00-7F	SCALE TUNING C#	-63...0...+63 [cent]	40	○	○	×	○ (Other Setting)	○	×	○
	43	1	00-7F	SCALE TUNING D	-63...0...+63 [cent]	40	○	○	×	○ (Other Setting)	○	×	○
	44	1	00-7F	SCALE TUNING D#	-63...0...+63 [cent]	40	○	○	×	○ (Other Setting)	○	×	○
	45	1	00-7F	SCALE TUNING E	-63...0...+63 [cent]	40	○	○	×	○ (Other Setting)	○	×	○
	46	1	00-7F	SCALE TUNING F	-63...0...+63 [cent]	40	○	○	×	○ (Other Setting)	○	×	○
	47	1	00-7F	SCALE TUNING F#	-63...0...+63 [cent]	40	○	○	×	○ (Other Setting)	○	×	○
	48	1	00-7F	SCALE TUNING G	-63...0...+63 [cent]	40	○	○	×	○ (Other Setting)	○	×	○
	49	1	00-7F	SCALE TUNING G#	-63...0...+63 [cent]	40	○	○	×	○ (Other Setting)	○	×	○
	4A	1	00-7F	SCALE TUNING A	-63...0...+63 [cent]	40	○	○	×	○ (Other Setting)	○	×	○
	4B	1	00-7F	SCALE TUNING A#	-63...0...+63 [cent]	40	○	○	×	○ (Other Setting)	○	×	○
	4C	1	00-7F	SCALE TUNING B	-63...0...+63 [cent]	40	○	○	×	○ (Other Setting)	○	×	○
	4D	1	28-58	CAT PITCH CONTROL	-24...0...+24 [semitones]	40	○	○	×	×	○	×	×
	4E	1	00-7F	CAT LOW PASS FILTER CONTROL	-9600...0...+9450 [cent]	40	○	○	×	×	○	×	×
	4F	1	00-7F	CAT AMPLITUDE CONTROL	-100...0...+100 [%]	40	○	○	×	×	○	×	×
	50	1	00-7F	CAT LFO PMOD DEPTH	0...127	00	○	○	×	×	○	×	×
	51	1	00-7F	CAT LFO FMOD DEPTH	0...127	00	○	○	×	×	○	×	×
	52	1	00-7F	CAT LFO AMOD DEPTH	0...127	00	○	○	×	×	○	×	×
	53	1	28-58	PAT PITCH CONTROL	-24...0...+24 [semitones]	40	○	×	×	×	○	×	×
	54	1	00-7F	PAT LOW PASS FILTER CONTROL	-9600...0...+9450 [cent]	40	○	×	×	×	○	×	×
	55	1	00-7F	PAT AMPLITUDE CONTROL	-100...0...+100 [%]	40	○	×	×	×	○	×	×
	56	1	00-7F	PAT LFO PMOD DEPTH	0...127	00	○	×	×	×	○	×	×
	57	1	00-7F	PAT LFO FMOD DEPTH	0...127	00	○	×	×	×	○	×	×
	58	1	00-7F	PAT LFO AMOD DEPTH	0...127	00	○	×	×	×	○	×	×
	59	1	00-5F	AC1 CONTROLLER NUMBER	0...95	10	○	×	×	×	○	×	×
	5A	1	28-58	AC1 PITCH CONTROL	-24...0...+24 [semitones]	40	○	×	×	×	○	×	×
	5B	1	00-7F	AC1 LOW PASS FILTER CONTROL	-9600...0...+9450 [cent]	40	○	×	×	×	○	×	×
	5C	1	00-7F	AC1 AMPLITUDE CONTROL	-100...0...+100 [%]	40	○	×	×	×	○	×	×
	5D	1	00-7F	AC1 LFO PMOD DEPTH	0...127	00	○	×	×	×	○	×	×
	5E	1	00-7F	AC1 LFO FMOD DEPTH	0...127	00	○	×	×	×	○	×	×
	5F	1	00-7F	AC1 LFO AMOD DEPTH	0...127	00	○	×	×	×	○	×	×
	60	1	00-5F	AC2 CONTROLLER NUMBER	0...95	11	○	×	×	×	○	×	×
	61	1	28-58	AC2 PITCH CONTROL	-24...0...+24 [semitones]	40	○	×	×	×	○	×	×
	62	1	00-7F	AC2 LOW PASS FILTER CONTROL	-9600...0...+9450 [cent]	40	○	×	×	×	○	×	×
	63	1	00-7F	AC2 AMPLITUDE CONTROL	-100...0...+100 [%]	40	○	×	×	×	○	×	×
	64	1	00-7F	AC2 LFO PMOD DEPTH	0...127	00	○	×	×	×	○	×	×
	65	1	00-7F	AC2 LFO FMOD DEPTH	0...127	00	○	×	×	×	○	×	×
	66	1	00-7F	AC2 LFO AMOD DEPTH	0...127	00	○	×	×	×	○	×	×
	67	1	00-01	PORTAMENTO SWITCH	OFF, ON	00	○	○	×	×	○	×	×
	68	1	00-7F	PORTAMENTO TIME	0...127	00	○	○	×	×	○	×	×
	69	1	00-7F	PITCH EG INITIAL LEVEL	-64...0...+63	40	○	×	×	×	○	×	×
	6A	1	00-7F	PITCH EG ATTACK TIME	-64...0...+63	40	○	×	×	×	○	×	×
	6B	1	00-7F	PITCH EG RELEASE LEVEL	-64...0...+63	40	○	×	×	×	○	×	×
	6C	1	00-7F	PITCH EG RELEASE TIME	-64...0...+63	40	○	×	×	×	○	×	×
	6D	1	01-7F	VELOCITY LIMIT LOW	1...127	01	○	×	×	×	○	×	×
	6E	1	01-7F	VELOCITY LIMIT HIGH	1...127	7F	○	×	×	×	○	×	×

TOTAL SIZE 3F

	70	1		NOT USED		-	-	-	-	-	-	-	-
	71	1		NOT USED		-	-	-	-	-	-	-	-
	72	1	00-7F	EQ BASS GAIN	-12dB...+12dB	40	○	○	×	○ (VOICE EDIT)	○	×	○
	73	1	00-7F	EQ TREBLE GAIN	-12dB...+12dB	40	○	○	×	○ (VOICE EDIT)	○	×	○

TOTAL SIZE 04

	74	1		NOT USED		-	-	-	-	-	-	-	-
	75	1		NOT USED		-	-	-	-	-	-	-	-
	76	1	04-28	EQ BASS FREQUENCY	32...2.0k[Hz]	0C	○	○	×	○ (VOICE EDIT)	○	×	○
	77	1	1C-3A	EQ TREBLE FREQUENCY	500...16.0k[Hz]	36	○	○	×	○ (VOICE EDIT)	○	×	○
	78	1		NOT USED		-	-	-	-	-	-	-	-
	79	1		NOT USED		-	-	-	-	-	-	-	-
	7A	1		NOT USED		-	-	-	-	-	-	-	-
	7B	1		NOT USED		-	-	-	-	-	-	-	-
	7C	1		NOT USED		-	-	-	-	-	-	-	-
	7D	1		NOT USED		-	-	-	-	-	-	-	-
	7E	1		NOT USED		-	-	-	-	-	-	-	-
	7F	1		NOT USED		-	-	-	-	-	-	-	-

TOTAL SIZE 0C

nn = PART NUMBER

If there is a Drum Voice assigned to the part, the following parameters are ineffective.

- BANK SELECT LSB
- MONO/POLY MODE
- SCALE TUNING
- PORTAMENTO
- PITCH EG
- FILTER MODULATION DEPTH (FMOD DEPTH)
- AMPLITUDE MODULATION DEPTH (AMOD DEPTH)

MIDI Parameter Change table (DRUM SETUP)

Address (H)	Size (H)	Data (H)	Parameter	Description	XG Default (H)	MIDI Reception (respond/ignore)			MIDI Transmission (generated data)			REC		
						Song	Main Layer Left Layer	Keyboard	Panel (main generation method)	Song	Midi		Recorded from panel	
3n	rr	00	1	00-7F	PITCH COARSE	-64...0...+63	40	○	×	×	×	○	×	×
		01	1	00-7F	PITCH FINE	-64...0...+63 [cent]	40	○	×	×	×	○	×	×
		02	1	00-7F	LEVEL	0...127	Depends on the note	○	×	×	×	○	×	×
		03	1	00-7F	ALTERNATE GROUP	OFF, 1...127	Depends on the note	○	×	×	×	○	×	×
		04	1	00-7F	PAN	RND, L63...C...R63	Depends on the note	○	×	×	×	○	×	×
		05	1	00-7F	REVERB SEND	0...127	Depends on the note	○	×	×	×	○	×	×
		06	1	00-7F	CHORUS SEND	0...127	Depends on the note	○	×	×	×	○	×	×
		07	1	00-7F	VARIATION SEND	0...127	7F	○	×	×	×	○	×	×
		08	1	00-01	KEY ASSIGN	SINGLE, MULTI	00	○	×	×	×	○	×	×
		09	1	00-01	Rcv NOTE OFF	OFF, ON	Depends on the note	○	×	×	×	○	×	×
		0A	1	00-01	Rcv NOTE ON	OFF, ON	01	○	×	×	×	○	×	×
		0B	1	00-7F	LOW PASS FILTER CUTOFF FREQUENCY	-64...0...+63	40	○	×	×	×	○	×	×
		0C	1	00-7F	LOW PASS FILTER RESONANCE	-64...0...+63	40	○	×	×	×	○	×	×
		0D	1	00-7F	EG ATTACK RATE	-64...0...+63	40	○	×	×	×	○	×	×
		0E	1	00-7F	EG DECAY1 RATE	-64...0...+63	40	○	×	×	×	○	×	×
		0F	1	00-7F	EG DECAY2 RATE	-64...0...+63	40	○	×	×	×	○	×	×

TOTAL SIZE 10

		20	1	00-7F	EQ BASS GAIN	-12...+12 [dB]	40	○	×	×	×	○	×	×
		21	1	00-7F	EQ TREBLE GAIN	-12...+12 [dB]	40	○	×	×	×	○	×	×
		22	1		NOT USED		-	-	-	-	-	-	-	-
		23	1		NOT USED		-	-	-	-	-	-	-	-
		24	1	04-28	EQ BASS FREQUENCY	32...2.0k [Hz]	0C	○	×	×	×	○	×	×
		25	1	1C-3A	EQ TREBLE FREQUENCY	500...16.0k [Hz]	36	○	×	×	×	○	×	×
		26	1		NOT USED		-	-	-	-	-	-	-	-
		27	1		NOT USED		-	-	-	-	-	-	-	-
		28	1		NOT USED		-	-	-	-	-	-	-	-
		29	1		NOT USED		-	-	-	-	-	-	-	-
		2A	1		NOT USED		-	-	-	-	-	-	-	-
		2B	1		NOT USED		-	-	-	-	-	-	-	-
		2C	1		NOT USED		-	-	-	-	-	-	-	-
		2D	1		NOT USED		-	-	-	-	-	-	-	-

TOTAL SIZE 0E

n: Drum Setup Number (0-1)  
 rr: note number (0D-5B)

In the following cases, the PF-500 will initialize all Drum Setups.

XG SYSTEM ON received

GM SYSTEM ON received

DRUM SETUP RESET received (only when in XG mode)

When a part to which a Drum Setup is assigned receives a program change, the assigned Drum Setup will be initialized.

If the same Drum Setup is assigned to two or more parts, changes in Drum Setup parameters (including program changes) will apply to all parts to which it is assigned.

System Exclusive Messages (1)

\*Not Received when Receive Parameter SysEx is set to off.  
 \*Not transmitted when Transmit Parameter SysEx is set to off.

System Exclusive Messages (Universal Realtime messages)

○: Available

MIDI Event	Data Format	MIDI Reception (effective or not for each part)			MIDI Reception (affecting the panel)	MIDI Transmission (generated data)			REC
		Song	Main Layer Left Layer	Keyboard		Panel (main generation method)	Song	Midi	
Master Volume	F0 7F XN 04 01 SS TT F7								
	11110000 F0 = Exclusive status								
	01111111 7F = Universal Real Time								
	0xxxxnnn XN = When N is received N = 0-F, whichever is received. X = ignored	○	×	×	×	×	×	×	×
	00000100 04 = Sub-ID #1 = Device Control Message								
	00000001 01 = Sub-ID #2 = Master Volume								
	0sssssss SS = Volume LSB 0ttttttt TT = Volume MSB 11110111 F7 = End of Exclusive								

System Exclusive Messages (Universal Non Realtime messages)

MIDI Event	Data Format	MIDI Reception (effective or not for each part)			MIDI Reception (affecting the panel)	MIDI Transmission (generated data)			REC
		Song	Main Layer Left Layer	Keyboard		Panel (main generation method)	Song	Midi	
GM1 System On	F0 7E XN 09 01 F7								
	11110000 F0 = Exclusive status								
	01111110 7E = Universal Non-Real Time								
	0xxxxnnn XN = When N is received N = 0-F, whichever is received. X = ignored	○	×	×	○	×	○	×	○
	00001001 09 = Sub-ID #1 = General MIDI Message								
	00000001 01 = Sub-ID #2 = General MIDI On 11110111 F7 = End of Exclusive								

# System Exclusive Messages (2)

\*Not received when the Receive Parameter SysEx is set to off.  
 \*Not transmitted when the Transmit Parameter SysEx is set to off.

## System Exclusive Messages (XG)

MIDI Event	Data Format	MIDI Reception (effective or not for each part)			MIDI Reception (affecting the panel)	MIDI Transmission (generated data)		
		Song	Main Layer Left Left Layer	Keyboard		Panel (main generation method)	Song	Midi
XG Parameter Change	F0 43 1n 4C hh mm ll dd ... F7							
	11110000 F0 = Exclusive status							
	01000011 43 = YAMAHA ID							
	0001nnnn 1n = Device Number n = always 0 (when transmit), n = 0-F (when receive)							
	01001100 4C = Model ID							
	0hhhhhhh hh = Address High							
	0mmmmmmmm mm = Address Mid							
	01111111 ll = Address Low							
	0ddddddd dd = Data							
:	:							
11110111 F7 = End of Exclusive								
		○			-		○	×
XG Bulk Dump	F0 43 0n 4C aa bb hh mm ll dd ... dd cc F7							
	11110000 F0 = Exclusive status							
	01000011 43 = YAMAHA ID							
	0000nnnn 0n = Device Number n = always 0 (when transmit), n = 0-F (when receive)							
	01001100 4C = Model ID							
	0aaaaaaa aa = Byte Count MSB							
	0bbbbbbb bb = Byte Count LSB							
	0hhhhhhh hh = Address High							
	0mmmmmmmm mm = Address Mid							
	01111111 ll = Address Low							
	0ddddddd dd = Data							
	:	:						
	0ddddddd dd = Data							
0ccccc cc = Checksum								
11110111 F7 = End of Exclusive								
		○			-		○	×
XG Parameter Request	F0 43 3n 4C hh mm ll F7							
	11110000 F0 = Exclusive status							
	01000011 43 = YAMAHA ID							
	0011nnnn 3n = Device Number n = always 0 (when transmit), n = 0-F (when receive)							
	01001100 4C = Model ID							
	0hhhhhhh hh = Address High							
	0mmmmmmmm mm = Address Mid							
	01111111 ll = Address Low							
	11110111 F7 = End of Exclusive							
		○			-		×	
XG Dump Request	F0 43 2n 4C hh mm ll dd F7							
	11110000 F0 = Exclusive status							
	01000011 43 = YAMAHA ID							
	0010nnnn 2n = Device Number n = always 0 (when transmit), n = 0-F (when receive)							
	01001100 4C = Model ID							
	0hhhhhhh hh = Address High							
	0mmmmmmmm mm = Address Mid							
	01111111 ll = Address Low							
	11110111 F7 = End of Exclusive							
		○			-		×	



System Exclusive Message (Preset Voice)

MIDI Event	Data Format	MIDI Reception (effective or not for each part)			MIDI Reception (affecting the panel)	MIDI Transmission (generated data)		
		Song	Main Layer Left Left Layer	Keyboard		Panel (main generation method)	Song	Midi
String Resonance Depth	F0 43 73 01 50 11 0n 02 dd F7							
	11110000 F0 = Exclusive status							
	01000011 43 = YAMAHA ID							
	01110011 73 = Clavinova ID							
	00000001 01 = Model ID (Clavinova common ID)							
	01010000 50 = Sub ID	○	○	×	○ (Other Setting)	○ (Other Setting)	○	×
	00010001 11 = Sub ID							
	0000nnnn 0n = Channel (00 – 0F)							
	00000010 02 = Sub ID (String Resonance Depth)							
	0ddddddd dd = Depth (00 – 48)							
11110111 F7 = End of Exclusive								
Sustain Sampling Depth	F0 43 73 01 50 11 0n 03 dd F7							
	11110000 F0 = Exclusive status							
	01000011 43 = YAMAHA ID							
	01110011 73 = Clavinova ID							
	00000001 01 = Model ID (Clavinova common ID)							
	01010000 50 = Sub ID	○	○	×	○ (Other Setting)	○ (Other Setting)	○	×
	00010001 11 = Sub ID							
	0000nnnn 0n = Channel (00 – 0F)							
	00000011 03 = Sub ID (Sustain Sampling Depth)							
	0ddddddd dd = Depth (00 – 48)							
11110111 F7 = End of Exclusive								
Key-off Sampling Depth	F0 43 73 01 50 11 0n 04 dd F7							
	11110000 F0 = Exclusive status							
	01000011 43 = YAMAHA ID							
	01110011 73 = Clavinova ID							
	00000001 01 = Model ID (Clavinova common ID)							
	01010000 50 = Sub ID	○	○	×	○ (Other Setting)	○ (Other Setting)	○	×
	00010001 11 = Sub ID							
	0000nnnn 0n = Channel (00 – 0F)							
	00000100 04 = Sub ID (Key-off Sampling Depth)							
	0ddddddd dd = Depth (00 – 50)							
11110111 F7 = End of Exclusive								
Soft Pedal Depth	F0 43 73 01 50 11 0n 05 dd F7							
	11110000 F0 = Exclusive status							
	01000011 43 = YAMAHA ID							
	01110011 73 = Clavinova ID							
	00000001 01 = Model ID (Clavinova common ID)							
	01010000 50 = Sub ID	○	○	×	○ (Other Setting)	○ (Other Setting)	○	×
	00010001 11 = Sub ID							
	0000nnnn 0n = Channel (00 – 0F)							
	00000101 05 = Sub ID (Soft Pedal Depth)							
	0ddddddd dd = Depth (00 – 7F)							
11110111 F7 = End of Exclusive								

\*For each Depth value, the reset value is 40H = Voice parameter.

System Exclusive Message (Other)

MIDI Event	Data Format	MIDI Reception (effective or not for each part)			MIDI Reception (affecting the panel)	MIDI Transmission (generated data)		
		Song	Main Layer Left Left Layer	Keyboard		Panel (main generation method)	Song	Midi
MIDI Master Tuning	F0 43 1n 27 30 00 00 0m 01 cc F7							
	11110000 F0 = Exclusive status							
	01000011 43 = YAMAHA ID							
	0001nnnn 1n n = always 0 (when transmit), n = 0-F (when receive)							
	00100111 27 = Model ID of TG100							
	00110000 30 = Address High							
	00000000 00 = Address Mid							
	00000000 00 = Address Low							
	0000mmmm 0m = Master Tune MSB							
	00001111 01 = Master Tune LSB							
0ccccccc cc = irrelevant								
11110111 F7 = End of Exclusive								

System Exclusive Message (Data Bulk )

MIDI Event	Data Format	MIDI Reception (effective or not for each part)			MIDI Reception (affecting the panel)	MIDI Transmission (generated data)																										
		Song	Main Layer Left Layer	Keyboard		Panel (main generation method)	Song	Midi																								
Data Bulk Dump	F0 43 0n xx yy zz aa bb cc dd hh mm ll dd ... dd sum F7																															
	11110000 F0 = Exclusive status																															
	01000011 43 = YAMAHA ID																															
	0000nnnn 0n = Device Number n = always 0																															
	0xxxxxxx 7F = Model ID High																															
	0zzzzzzz 04 = Model ID Low																															
	0aaaaaaa aa = Byte Count MSB																															
	0bbbbbbb bb = Byte Count LSB																															
	0ccccccc cc = The number of available MSB																															
	0ddddddd dd = The number of available LSB																															
0hhhhhhh hh = Address High																																
0mmmmmmm mm = Address Mid																																
01111111 ll = Address Low																																
0ddddddd dd = Data																																
:	:																															
0ddddddd dd = Data																																
0ccccccc cc = Checksum																																
	<table border="1"> <thead> <tr> <th>Function</th> <th>Address High</th> <th>Address Mid</th> <th>Address Low</th> </tr> </thead> <tbody> <tr> <td>Bulk Header</td> <td>10</td> <td>00</td> <td>00</td> </tr> <tr> <td>Current (End)</td> <td>20</td> <td>00 7F</td> <td>00 7F</td> </tr> <tr> <td>Performance (End)</td> <td>30</td> <td>00 7F</td> <td>00 7F</td> </tr> <tr> <td>Voice Setting (End)</td> <td>40</td> <td>00 7F</td> <td>00 7F</td> </tr> <tr> <td>Bulk Footer</td> <td>11</td> <td>00</td> <td>00</td> </tr> </tbody> </table>	Function	Address High	Address Mid	Address Low	Bulk Header	10	00	00	Current (End)	20	00 7F	00 7F	Performance (End)	30	00 7F	00 7F	Voice Setting (End)	40	00 7F	00 7F	Bulk Footer	11	00	00	-	-	-	-	○ (Bulk)	×	○ (Bulk Request)
Function	Address High	Address Mid	Address Low																													
Bulk Header	10	00	00																													
Current (End)	20	00 7F	00 7F																													
Performance (End)	30	00 7F	00 7F																													
Voice Setting (End)	40	00 7F	00 7F																													
Bulk Footer	11	00	00																													
		-	○	○	○ (Other than the Data Bulk)	○ (Bulk Current)	×	○ (Bulk Request)																								
		-	-	-	○ (Performance)	○ (Bulk Performance)	×	○ (Bulk Request)																								
		-	-	-	- (Voice Setting)	○ (Bulk Voice)	×	○ (Bulk Request)																								
		-	-	-	-	○ (Bulk)	×	○ (Bulk Request)																								
Data Bulk Dump Request	F0 43 2n xx yy zz hh mm ll F7																															
	11110000 F0 = Exclusive status																															
	01000011 43 = YAMAHA ID																															
	0000nnnn 2n = Device Number n = always 0																															
	0xxxxxxx 7F = Model ID High																															
0zzzzzzz 04 = Model ID Low																																
0hhhhhhh hh = Address High																																
0mmmmmmm mm = Address Mid																																
01111111 ll = Address Low																																
	<table border="1"> <thead> <tr> <th>Function</th> <th>Address High</th> <th>Address Mid</th> <th>Address Low</th> </tr> </thead> <tbody> <tr> <td>Current, Performance, Voice Setting</td> <td>00</td> <td>00</td> <td>00</td> </tr> </tbody> </table>	Function	Address High	Address Mid	Address Low	Current, Performance, Voice Setting	00	00	00	-	-	-	-	×	×	×																
Function	Address High	Address Mid	Address Low																													
Current, Performance, Voice Setting	00	00	00																													

Function...	Transmitted	Recognized	Remarks	
Basic Channel	Default Changed	1 - 16 1 - 16	1 - 16 1 - 16	
Mode	Default Messages Altered	3 X *****	3 X X	
Note Number : True voice		0 - 127 *****	0 - 127 0 - 127	
Velocity	Note ON Note OFF	O 9nH,v=1-127 X 9nH,v=0	O 9nH,v=1-127 X	
After Touch	Key's Ch's	X X	O O	
Pitch Bend		O	O 0 - 24 semi	
Control Change	0,32 1 5 7,10,11 6,38 64,66,67 65 71,74 72,73 84,94 91,93 96-97 98-99 100-101 1-119	O O X O O O X O X X O O X X O O (Assignable)	O O O O O O O O O O O O O O O X	Bank Select Modulation Portamento Time  Data Entry  Portamento Sound Controller Sound Controller  RPN Inc,Dec NRPN LSB,MSB RPN LSB,MSB *1
Prog Change : True #		O 0 - 127 *****	O 0 - 127	
System Exclusive		O	O	
Common : Song Pos. : Song Sel. : Tune	X X X	X X X		
System : Clock Real Time : Commands	O O	X O		
Aux : All Sound Off : Reset All Cntrls : Local ON/OFF Mes- : All Notes OFF sages: Active Sense : Reset	X X X X O X	O (120,126,127) O (121) X (122) O (123-125) O X		
Note : *1= Transmission only				

Mode 1 : OMNI ON , POLY                      Mode 2 : OMNI ON , MONO                      O : Yes  
 Mode 3 : OMNI OFF, POLY                      Mode 4 : OMNI OFF, MONO                      X : No

# Specifications

Item	CP300
Keyboard	GH keyboard 88 keys (A-1 – C7)
Sound Source	AWM Dynamic Stereo Sampling
Polyphony (max.)	128
Voice Selection	Presets: 50 Voices XG Voices: 480 Voices + 12 Drum kits
Performance	64 Performances x 56 files (max.)
Effect*	Reverb*, Chorus*, Master Equalizer, Variation effect*, Insertion effect* x 3
Controller	Master Volume Dial, Pitch Bend Wheel, Modulation Wheel, Master Equalizer Slider, Zone Control Slider, Song Volume Slider
Display	24 characters x 2 lines, LCD with back-light
Recording/Playback	16-track recording/playback, Tempo adjustment, max. capacity: 1.4 MB, 140,000 notes
Jacks/Connectors	MIDI (IN/OUT/THRU), PHONES, INPUT (L/MONO, R), OUTPUT (L/MONO, R), OUTPUT (L/R), ASSIGNABLE FOOT PEDAL (SUSTAIN/SOSTENUTO/SOFT/AUX), USB TO HOST, AC INLET
Main Amplifiers	30 W x 2
Speakers	13 cm x 2
Dimensions (W x D x H)	1391 x 460 x 170mm (54-3/4" x 18-1/8" x 6-15/16")
Weight	32.5 kg (71 lbs., 10 oz)
Accessories	AC Power Cord, Foot Pedal FC3, Owner's Manual

\*: Refer to the Effect Type List on page 114.

Specifications and descriptions in this owner's manual are for information purposes only. Yamaha Corp. reserves the right to change or modify products or specifications at any time without prior notice. Since specifications, equipment or options may not be the same in every locale, please check with your Yamaha dealer.

# Index

## Numerics

[1] – [16] buttons ..... 73

## A

A [-][+] buttons ..... 15  
 [AC INLET] jack ..... 11  
 Application Index ..... 10  
 [ASSIGNABLE FOOT PEDAL] jacks ..... 11  
 [AUX] jack ..... 33  
 AUX pedal ..... 33

## B

B [- (NO)][+(YES)] buttons ..... 15  
 Bar ..... 42  
 Basic operation ..... 15  
 Bulk Dump ..... 66

## C

C [-][+] button ..... 15  
 Character Code ..... 84  
 Chorus ..... 35  
 [CHORUS] button ..... 35  
 Click ..... 38  
 [CLICK] button ..... 38  
 Connections  
     computer ..... 92  
     external audio equipment ..... 88  
     external instrument ..... 89  
     external MIDI keyboard ..... 90  
 [CONTRAST] knob ..... 13  
 Current memory ..... 82

## D

D [-][+] buttons ..... 15  
 Delete  
     Performance file ..... 80  
     Song file ..... 83  
 Demo Songs ..... 23  
 Display  
     adjust the brightness ..... 13  
     settings ..... 15  
 Dual ..... 29

## E

Effect Data Assign Table ..... 123  
 Effect Parameter List ..... 115  
 Effect Type List ..... 114  
 Equalizer (EQ) ..... 36  
 [EXIT] button ..... 15

## F

Factory Set ..... 16, 71

Factory Setting List ..... 101  
 Factory-programmed settings ..... 16  
 Fast Forward ..... 50  
 Fast Rewind ..... 50  
 File ..... 17

## G

GM System Level 1 ..... 100

## H

Headphones ..... 12

## I

INPUT [L/MONO][R] jack ..... 89  
 Insertion effect ..... 35

## K

Keyboard part combinations ..... 27

## L

Layer part ..... 27  
 Left Layer part ..... 27  
 Left part ..... 27

## List

    Effect Parameter List ..... 115  
     Effect Type List ..... 114  
     Factory Setting List ..... 101  
     Master Settings ..... 102  
     Message List ..... 94  
     MIDI Settings ..... 101  
     Other Settings ..... 101  
     Preset Performance List ..... 106  
     Program Change List ..... 105  
     Song Settings ..... 102  
     Voice List ..... 103  
     XG Drum Kit List ..... 112  
     XG Voice List ..... 108  
 Load From Memory ..... 79

## M

Main part ..... 27  
 [MASTER] button ..... 39  
 [MASTER EDIT] button ..... 53  
 Master EQ ..... 36  
 MASTER EQ EDIT [▼][▲] buttons ..... 72  
 Master Equalizer settings ..... 72  
 [MASTER EQUALIZER] sliders ..... 36  
 Master mode ..... 39  
 Master settings ..... 53  
 Master Volume ..... 13  
 [MASTER VOLUME] dial ..... 13  
 Memory ..... 49  
 Memory Backup ..... 71

## Index

Message List .....	94
MIDI [IN][OUT][THRU] connectors .....	90
MIDI channel .....	63
MIDI data compatibility .....	100
MIDI Data Format .....	125
MIDI Implementation Chart .....	137
[MIDI OUT] button .....	51
MIDI Panic .....	52
[MIDI SETTING] button .....	64
MIDI Settings .....	63
Modulation wheel .....	34

## O

[OTHER SETTING] button .....	67
Other Settings .....	67
OUTPUT [L/MONO][R] jacks .....	88
OUTPUT [L][R] jacks .....	89

## P

Panel Lock .....	51
[PANEL LOCK] button .....	51
Parameter	
Master Edit .....	54
MIDI Settings .....	65
Other Settings .....	68
Song Settings .....	86
Voice Edit .....	58
Part EQ .....	36
Pedal .....	33
Pedal functions .....	61, 62
Perf. Name .....	78
[PERFORM.FILE] button .....	76
Performance .....	77
rename .....	78
save to a button .....	77
[PERFORMANCE] button .....	40
Performance file	
basic operation .....	76
defined .....	73
delete .....	80
recall from the storage memory .....	79
rename .....	80
save as .....	79
Performance functions .....	73
Performance parameters .....	74
[PHONES] jack .....	12
Pitch Bend wheel .....	34
[POWER] switch .....	11, 12
Precautions .....	4
Preset .....	18, 49
Preset Performance file .....	40
Preset Performance List .....	106
Program Change List .....	105

## Q

Quantize .....	86
----------------	----

## R

[REC] button .....	42
Recording	
Dual mode .....	48
live performance .....	41, 42
Split mode .....	48
Recording Techniques	
adding data .....	46
changing Tempo after recording .....	46
changing Voice after recording .....	46
overwriting .....	46
re-recording parts .....	44
Recording track .....	42
Rename	
Performance .....	78
Performance file .....	80
Song file .....	83
Rename File .....	80
Rename Song .....	83
Reverb .....	35
[REVERB] button .....	35

## S

Save	
Performance .....	77
Performance file .....	79
Recorded Song .....	82
Save As .....	79
Save To Memory .....	82
Scale .....	68
[SOFT] jack .....	33
Soft pedal .....	33
Song .....	41
Song file	
basic operation .....	81
defined .....	81
delete .....	83
rename .....	83
save to memory .....	82
Song playback .....	49
Song Repeat .....	87
SONG SELECT [◀◀][▶▶] buttons .....	42, 49
Song Settings .....	85
[SONG VOLUME] slider .....	47
[SOSTENUTO] jack .....	33
Sostenuto pedal .....	33
[SPEAKER] button .....	52
Speakers (built-in) On/Off .....	52
Specifications .....	138
Split .....	31
[SPLIT] button .....	31
Split Point .....	32, 69
Storage memory .....	17, 73, 82
[SUSTAIN] jack .....	33
Sustain pedal .....	33
Synchro Start .....	50
System effect .....	35

<b>T</b>	
Tempo .....	38
TEMPO [DOWN] [UP] buttons .....	38
Time Signature .....	87
Touch .....	61, 68
TRACK [1][2][3-16] buttons .....	42, 50
Transpose .....	37
[TRANPOSE] button .....	37
Troubleshooting .....	98
Tune .....	68
<b>U</b>	
[USB] connector .....	92
<b>V</b>	
VARIATION [▼][▲] buttons .....	25
Voice .....	25
Voice Edit .....	56
[VOICE EDIT] button .....	56
Voice List .....	103
[VOICE/PERFORMANCE] button .....	25, 40, 73
Volume	
adjusting each part .....	28
adjusting Master Volume .....	13, 23
adjusting Song Volume .....	23, 47
<b>X</b>	
XG .....	100
XG Drum Kit List .....	112
XG Voice .....	26
XG Voice List .....	108
<b>Z</b>	
Zone Control .....	28, 39
[ZONE CONTROL] sliders .....	28, 39



## LIMITED 3-YEAR WARRANTY ON DIGITAL PIANOS (P, CP, YDP, DGX640, DGX650)

Thank you for selecting a YAMAHA product. YAMAHA products are designed and manufactured to provide a high level of defect-free performance. Yamaha Corporation of America ("YAMAHA") is proud of the experience and craftsmanship that goes into each and every YAMAHA product. YAMAHA sells its products through a network of reputable, specially authorized dealers and is pleased to offer you, the Original Owner, the following Limited Warranty, which applies only to products that have been (1) directly purchased from YAMAHA's authorized dealers in the fifty states of the USA and District of Columbia (the "Warranted Area") and (2) used exclusively in the Warranted Area. YAMAHA suggests that you read the Limited Warranty thoroughly, and invites you to contact your authorized YAMAHA dealer or YAMAHA Customer Service if you have any questions.

**Coverage:** YAMAHA will, at its option, repair or replace the product covered by this warranty if it becomes defective, malfunctions or otherwise fails to conform with this warranty under normal use and service during the term of this warranty, without charge for labor or materials. Repairs may be performed using new or refurbished parts that meet or exceed YAMAHA specifications for new parts. If YAMAHA elects to replace the product, the replacement may be a reconditioned unit. You will be responsible for any installation or removal charges and for any initial shipping charges if the product(s) must be shipped for warranty service. However, YAMAHA will pay the return shipping charges to any destination within the USA if the repairs are covered by the warranty. This warranty does not cover (a) damage, deterioration or malfunction resulting from accident, negligence, misuse, abuse, improper installation or operation or failure to follow instructions according to the Owner's Manual for this product; any shipment of the product (claims must be presented to the carrier); repair or attempted repair by anyone other than YAMAHA or an authorized YAMAHA Service Center; (b) any unit which has been altered or on which the serial number has been defaced, modified or removed; (c) normal wear and any periodic maintenance; (d) deterioration due to perspiration, corrosive atmosphere or other external causes such as extremes in temperature or humidity; (e) damages attributable to power line surge or related electrical abnormalities, lightning damage or acts of God; or (f) RFI/EMI (Interference/noise) caused by improper grounding or the improper use of either certified or uncertified equipment, if applicable. Any evidence of alteration, erasing or forgery of proof-of-purchase documents will cause this warranty to be void. This warranty covers only the Original Owner and is not transferable.

**In Order to Obtain Warranty Service:** Warranty service will only be provided for defective products within the Warranted Area. Contact your local authorized YAMAHA dealer who will advise you of the procedures to be followed. If this is not successful, contact YAMAHA at the address, telephone number or website shown below. YAMAHA may request that you send the defective product to a local authorized YAMAHA Servicer or authorize return of the defective product to YAMAHA for repair. If you are uncertain as to whether a dealer has been authorized by YAMAHA, please contact YAMAHA's Service Department at the number shown below, or check Yamaha's website at [www.usa.yamaha.com](http://www.usa.yamaha.com). Product(s) shipped for service should be packed securely and must be accompanied by a detailed explanation of the problem(s) requiring service, together with the original or a machine reproduction of the bill of sale or other dated, proof-of-purchase document describing the product, as evidence of warranty coverage. Should any product submitted for warranty service be found ineligible therefore, an estimate of repair cost will be furnished and the repair will be accomplished only if requested by you and upon receipt of payment or acceptable arrangement for payment.

**Limitation of Implied Warranties and Exclusion of Damages:** ANY IMPLIED WARRANTIES, INCLUDING WARRANTIES OF MERCHANTABILITY AND FITNESS FOR A PARTICULAR PURPOSE SHALL BE LIMITED IN DURATION TO THE APPLICABLE PERIOD OF TIME SET FORTH ABOVE. YAMAHA SHALL NOT BE RESPONSIBLE FOR INCIDENTAL OR CONSEQUENTIAL DAMAGES OR FOR DAMAGES BASED UPON INCONVENIENCE, LOSS OF USE, DAMAGE TO ANY OTHER EQUIPMENT OR OTHER ITEMS AT THE SITE OF USE OR INTERRUPTION OF PERFORMANCES OR ANY CONSEQUENCES THEREOF. YAMAHA'S LIABILITY FOR ANY DEFECTIVE PRODUCT IS LIMITED TO REPAIR OR REPLACEMENT OF THE PRODUCT, AT YAMAHA'S OPTION. SOME STATES DO NOT ALLOW LIMITATIONS ON HOW LONG AN IMPLIED WARRANTY LASTS OR THE EXCLUSION OR LIMITATION OF INCIDENTAL OR CONSEQUENTIAL DAMAGES, SO THE ABOVE LIMITATION OR EXCLUSION MAY NOT APPLY TO YOU. This Warranty gives you specific legal rights, and you may also have other rights which vary from state to state. This is the only express warranty applicable to the Product specified herein; Yamaha neither assumes nor authorizes anyone to assume for it any other express warranty.

If you have any questions about service received or if you need assistance in locating an authorized YAMAHA Servicer, please contact:



CUSTOMER SERVICE  
Yamaha Corporation of America  
6600 Orangethorpe Avenue, Buena Park, California 90620-1373  
Telephone: 800-854-1569  
[www.usa.yamaha.com](http://www.usa.yamaha.com)

**Do not return any product to the above address without a written Return Authorization issued by YAMAHA.**

© 2013 Yamaha Corporation of America.



For details of products, please contact your nearest Yamaha representative or the authorized distributor listed below.

Pour plus de détails sur les produits, veuillez-vous adresser à Yamaha ou au distributeur le plus proche de vous figurant dans la liste suivante.

Die Einzelheiten zu Produkten sind bei Ihrer unten aufgeführten Niederlassung und bei Yamaha Vertragshändlern in den jeweiligen Bestimmungsländern erhältlich.

Para detalles sobre productos, contacte su tienda Yamaha más cercana o el distribuidor autorizado que se lista debajo.

## NORTH AMERICA

### CANADA

**Yamaha Canada Music Ltd.**  
135 Milner Avenue, Toronto, Ontario,  
M1S 3R1, Canada  
Tel: 416-298-1311

### U.S.A.

**Yamaha Corporation of America**  
6600 Orangethorpe Avenue, Buena Park, CA 90620,  
U.S.A.  
Tel: 714-522-9011

## CENTRAL & SOUTH AMERICA

### MEXICO

**Yamaha de México, S.A. de C.V.**  
Av. Insurgentes Sur 1647 "Prisma Insurgentes",  
Col. San Jose Insurgentes, Del. Benito Juarez,  
03900, Mexico, D.F.  
Tel: 55-5804-0600

### BRAZIL

**Yamaha Musical do Brasil Ltda.**  
Rua Joaquim Floriano, 913 - 4º andar, Itaim Bibi,  
CEP 04534-013 São Paulo, SP. BRAZIL  
Tel: 011-3704-1377

### ARGENTINA

**Yamaha Music Latin America, S.A.,  
Sucursal Argentina**  
Olga Cossettini 1553, Piso 4 Norte,  
Madero Este-C1107CEK  
Buenos Aires, Argentina  
Tel: 54-11-4119-7000

### VENEZUELA

**Yamaha Music Latin America, S.A.,  
Sucursal Venezuela**  
C.C. Manzanares Plaza P4  
Ofic. 0401- Manzanares-Baruta  
Caracas Venezuela  
Tel: 58-212-943-1877

### PANAMA AND OTHER LATIN AMERICAN COUNTRIES/ CARIBBEAN COUNTRIES

**Yamaha Music Latin America, S.A.**  
Torre Banco General, Piso No.7, Marbella,  
Calle 47 y Aquilino de la Guardia,  
Ciudad de Panamá, República de Panamá  
Tel: +507-269-5311

## EUROPE

### THE UNITED KINGDOM/IRELAND

**Yamaha Music Europe GmbH (UK)**  
Sherbourne Drive, Tilbrook, Milton Keynes,  
MK7 8BL, U.K.  
Tel: 01908-366700

### GERMANY

**Yamaha Music Europe GmbH**  
Siemensstraße 22-34, 25462 Rellingen, Germany  
Tel: 04101-3030

### SWITZERLAND/LIECHTENSTEIN

**Yamaha Music Europe GmbH  
Branch Switzerland in Zürich**  
Seefeldstrasse 94, 8008 Zürich, Switzerland  
Tel: 044-387-8080

### AUSTRIA

**Yamaha Music Europe GmbH Branch Austria**  
Schleiergasse 20, A-1100 Wien, Austria  
Tel: 01-60203900

### CZECH REPUBLIC/HUNGARY/ ROMANIA/SLOVAKIA/SLOVENIA

**Yamaha Music Europe GmbH  
Branch Austria (Central Eastern Europe Office)**  
Schleiergasse 20, A-1100 Wien, Austria  
Tel: 01-60203900

### POLAND/LITHUANIA/LATVIA/ ESTONIA

**Yamaha Music Europe GmbH  
Branch Poland Office**  
ul. Wrotkowa 14 02-553 Warsaw, Poland  
Tel: 022-500-2925

### BULGARIA

**Dinacord Bulgaria LTD.**  
Bul. Iskarsko Schose 7 Targowski Zentar Ewropa  
1528 Sofia, Bulgaria  
Tel: 02-978-20-25

### MALTA

**Olimpus Music Ltd.**  
The Emporium, Level 3, St. Louis Street Msida  
MSD06  
Tel: 02133-2144

## NETHERLANDS/BELGIUM/ LUXEMBOURG

**Yamaha Music Europe Branch Benelux**  
Clarissenhof 5-b, 4133 AB Vianen, Netherlands  
Tel: 0347-358 040

### FRANCE

**Yamaha Music Europe**  
7 rue Ambroise Croizat, Zone d'activites Pariest,  
77183 Croissy-Beaubourg, France  
Tel: 01-64-61-4000

### ITALY

**Yamaha Music Europe GmbH, Branch Italy**  
Viale Italia 88, 20020 Lainate (Milano), Italy  
Tel: 02-935-771

### SPAIN/PORTUGAL

**Yamaha Music Europe GmbH Ibérica, Sucursal  
en España**  
Ctra. de la Coruna km. 17,200, 28231  
Las Rozas (Madrid), Spain  
Tel: +34-91-639-88-88

### GREECE

**Philippos Nakas S.A. The Music House**  
147 Skiathou Street, 112-55 Athens, Greece  
Tel: 01-228 2160

### SWEDEN

**Yamaha Music Europe GmbH Germany filial  
Scandinavia**  
J. A. Wettergrensgata 1, Box 30053  
S-400 43 Göteborg, Sweden  
Tel: +46 31 89 34 00

### DENMARK

**Yamaha Music Europe GmbH, Tyskland - filial  
Denmark**  
Generatorvej 6A, DK-2730 Herlev, Denmark  
Tel: 44 92 49 00

### FINLAND

**F-Musiikki Oy**  
Kluuvikatu 6, P.O. Box 260,  
SF-00101 Helsinki, Finland  
Tel: 09 618511

### NORWAY

**Yamaha Music Europe GmbH Germany -  
Norwegian Branch**  
Grimi Næringspark 1, N-1361 Østerås, Norway  
Tel: 67 16 78 00

### ICELAND

**Skifan HF**  
Skeifan 17 P.O. Box 8120, IS-128 Reykjavik,  
Iceland  
Tel: 525 5000

### RUSSIA

**Yamaha Music (Russia) LLC.**  
Room 37, bld. 7, Kievskaya street, Moscow,  
121059, Russia  
Tel: 495 626 5005

### OTHER EUROPEAN COUNTRIES

**Yamaha Music Europe GmbH**  
Siemensstraße 22-34, 25462 Rellingen, Germany  
Tel: +49-4101-3030

## AFRICA

### SOUTH AFRICA

**Global Music Instruments**  
Unit 4, 130 Boeing Road East Bedfordview 2008  
Postnet Suite 130, Private Bag X10020 Edenvale  
1610, South Africa  
Tel: 27-11-454-1131

### OTHER AFRICAN COUNTRIES

**Yamaha Music Gulf FZE**  
LOB 16-513, P.O.Box 17328, Jebel Ali,  
Dubai, United Arab Emirates  
Tel: +971-4-881-5868

## MIDDLE EAST

### TURKEY/CYPRUS

**Yamaha Music Europe GmbH**  
Merkezi Almanya Türkiye İstanbul Şubesi  
Maslak Meydan Sokak No:5 Spring Giz Plaza  
Bağışız B61. No:3, 34398 Şişli, İstanbul  
Tel: +90-212-999-8010

### OTHER COUNTRIES

**Yamaha Music Gulf FZE**  
LOB 16-513, P.O.Box 17328, Jebel Ali,  
Dubai, United Arab Emirates  
Tel: +971-4-881-5868

## ASIA

### THE PEOPLE'S REPUBLIC OF CHINA

**Yamaha Music & Electronics (China) Co., Ltd.**  
2F, Yunhedasha, 1818 Xinzha-lu, Jingan-qu,  
Shanghai, China  
Tel: 021-6247-2211

### HONG KONG

**Tom Lee Music Co., Ltd.**  
11/F., Silvercord Tower 1, 30 Canton Road,  
Tsimshatsui, Kowloon, Hong Kong  
Tel: 2737-7688

### INDIA

**Yamaha Music India Pvt. Ltd.**  
Spazedge building, Ground Floor, Tower A, Sector  
47, Gurgaon- Sohna Road, Gurgaon, Haryana, India  
Tel: 0124-485-3300

### INDONESIA

**PT. Yamaha Musik Indonesia (Distributor)**  
Yamaha Music Center Bldg. Jalan Jend. Gatot  
Subroto Kav. 4, Jakarta 12930, Indonesia  
Tel: 021-520-2577

### KOREA

**Yamaha Music Korea Ltd.**  
8F, 9F, Dongsung Bldg. 158-9 Samsung-Dong,  
Kangnam-Gu, Seoul, Korea  
Tel: 02-3467-3300

### MALAYSIA

**Yamaha Music (Malaysia) Sdn., Bhd.**  
No.8, Jalan Perbandaran, Kelana Jaya, 47301  
Petaling Jaya, Selangor, Malaysia  
Tel: 03-78030900

### PHILIPPINES

**Yupango Music Corporation**  
339 Gil J. Puyat Avenue, P.O. Box 885 MCPO,  
Makati, Metro Manila, Philippines  
Tel: 819-7551

### SINGAPORE

**Yamaha Music (Asia) Private Limited**  
Block 202 Hougang Street 21, #02-00,  
Singapore 530202, Singapore  
Tel: 65-6747-4374

### TAIWAN

**Yamaha Music & Electronics Taiwan Co., Ltd.**  
3F, No.6, Section 2 Nan-Jing East Road, Taipei,  
Taiwan R.O.C.  
Tel: 02-2511-8688

### THAILAND

**Siam Music Yamaha Co., Ltd.**  
3, 4, 15 and 16th floor, Siam Motors Building,  
891/1 Rama 1 Road, Wangmai,  
Pathumwan, Bangkok 10330, Thailand  
Tel: 02-215-2622

### VIETNAM

**Yamaha Music Vietnam Company Limited**  
15th Floor, Nam A Bank Tower, 201-203 Cach  
Mang Thang Tam St., Ward 4, Dist.3,  
Ho Chi Minh City, Vietnam  
Tel: +84-8-3818-1122

### OTHER ASIAN COUNTRIES

**Yamaha Corporation  
Market Development Section**  
Nakazawa-cho 10-1, Naka-ku, Hamamatsu,  
Japan 430-8650  
Tel: +81-53-460-2312

## OCEANIA

### AUSTRALIA

**Yamaha Music Australia Pty. Ltd.**  
Level 1, 99 Queensbridge Street, Southbank,  
Victoria 3006, Australia  
Tel: 3-9693-5111

### NEW ZEALAND

**Musik Works LTD**  
P.O.BOX 6246 Wellesley, Auckland 4680,  
New Zealand  
Tel: 9-634-0099

### COUNTRIES AND TRUST TERRITORIES IN PACIFIC OCEAN

**Yamaha Corporation  
Market Development Section**  
Nakazawa-cho 10-1, Naka-ku, Hamamatsu,  
Japan 430-8650  
Tel: +81-53-460-2312



Yamaha Web Site (English only)  
<http://www.yamahasynt.com/>  
Yamaha Downloads  
<http://download.yamaha.com/>

C.S.G., Digital Musical Instruments Division  
© 2006 - 2014 Yamaha Corporation

404MWCP\*.\*-01C0  
Printed in Japan

WG78300