



AW4416

PROFESSIONAL AUDIO WORKSTATION

Operation Guide



FCC INFORMATION (U.S.A.)

1. **IMPORTANT NOTICE: DO NOT MODIFY THIS UNIT!** This product, when installed as indicated in the instructions contained in this manual, meets FCC requirements. Modifications not expressly approved by Yamaha may void your authority, granted by the FCC, to use the product.
2. **IMPORTANT:** When connecting this product to accessories and/or another product use only high quality shielded cables. Cable/s supplied with this product **MUST** be used. Follow all installation instructions. Failure to follow instructions could void your FCC authorization to use this product in the USA.
3. **NOTE:** This product has been tested and found to comply with the requirements listed in FCC Regulations, Part 15 for Class "B" digital devices. Compliance with these requirements provides a reasonable level of assurance that your use of this product in a residential environment will not result in harmful interference with other electronic devices. This equipment generates/uses radio frequencies and, if not installed and used according to the instructions found in the users manual, may cause interference harmful to the operation of other electronic devices. Compliance with FCC regulations does not guarantee that interference will not occur in all installations. If this product is found to be the source of interference, which can be determined by turning the unit "OFF" and "ON", please try to eliminate the problem by using one of the following measures: Relocate either this product or the device that is being affected by the interference. Utilize power outlets that are on different branch (circuit breaker or fuse) circuits or install AC line filter/s. In the case of radio or TV interference, relocate/reorient the antenna. If the antenna lead-in is 300 ohm ribbon lead, change the lead-in to coaxial type cable. If these corrective measures do not produce satisfactory results, please contact the local retailer authorized to distribute this type of product. If you can not locate the appropriate retailer, please contact Yamaha Corporation of America, Electronic Service Division, 6600 Orangethorpe Ave, Buena Park, CA 90620

The above statements apply **ONLY** to those products distributed by Yamaha Corporation of America or its subsidiaries.

ADVARSEL!

Lithiumbatteri—Eksplussionsfare ved fejlagtig håndtering. Udskiftning må kun ske med batteri af samme fabrikat og type. Levér det brugte batteri tilbage til leverandoren.

VARNING

Explosionsfara vid felaktigt batteribyte. Använd samma batterityp eller en ekvivalent typ som rekommenderas av apparatillverkaren. Kassera använt batteri enligt fabrikantens instruktion.

VAROITUS

Paristo voi räjähtää, jos se on virheellisesti asennettu. Vaihda paristo ainoastaan laitevalmistajan suosittelemaan tyyppiin. Hävitä käytetty paristo valmistajan ohjeiden mukaisesti.

WARNING: THIS APPARATUS MUST BE EARTHED

IMPORTANT

THE WIRES IN THIS MAINS LEAD ARE COLOURED IN ACCORDANCE WITH THE FOLLOWING CODE:

GREEN-AND-YELLOW :	EARTH
BLUE :	NEUTRAL
BROWN :	LIVE

As the colours of the wires in the mains lead of this apparatus may not correspond with the coloured markings identifying the terminals in your plug, proceed as follows:

The wire which is coloured GREEN and YELLOW must be connected to the terminal in the plug which is marked by the letter E or by the safety earth symbol \perp or coloured GREEN and YELLOW.

The wire which is coloured BLUE must be connected to the terminal which is marked with the letter N or coloured BLACK.

The wire which is coloured BROWN must be connected to the terminal which is marked with the letter L or coloured RED.

* This applies only to products distributed by YAMAHA KEMBLE MUSIC (U.K.) LTD.

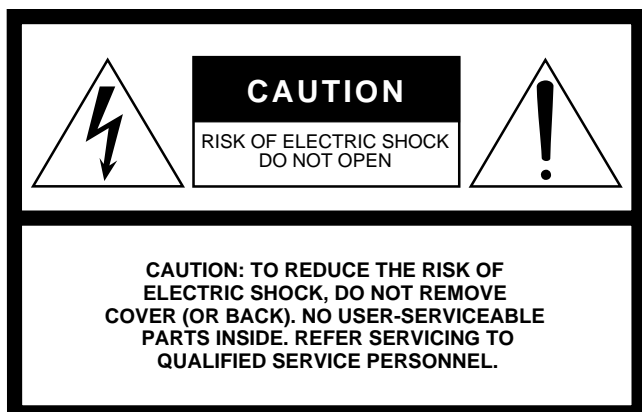

The above warning is located on the rear of the unit

• Explanation of Graphical Symbols



The exclamation point within an equilateral triangle is intended to alert the user to the presence of important operating and maintenance (servicing) instructions in the literature accompanying the product.

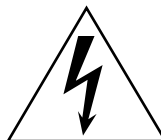

The lightning flash with arrowhead symbol within an equilateral triangle is intended to alert the user to the presence of uninsulated "dangerous voltage" within the product's enclosure that may be of sufficient magnitude to constitute a risk of electric shock to persons.

NEDERLAND

- Dit apparaat bevat een lithium batterij voor geheugen back-up.
- Raadpleeg uw leverancier over de verwijdering van de batterij op het moment dat u het apparaat aan het einde van de levensduur afdankt of de volgende Yamaha Service Afdeling:
Yamaha Music Nederland Service Afdeling
Kanaalweg 18-G, 3526 KL UTRECHT
Tel. 030-2828425
- Gooi de batterij niet weg, maar lever hem in als KCA.

THE NETHERLANDS

- This apparatus contains a lithium battery for memory back-up.
- For the removal of the battery at the moment of the disposal at the end of the service life please consult your retailer or Yamaha Service Center as follows:
Yamaha Music Nederland Service Center
Address: Kanaalweg 18-G, 3526 KL
UTRECHT
Tel: 030-2828425
- Do not throw away the battery. Instead, hand it in as small chemical waste.

Important

Read the following before operating the AW4416

☐ Warnings

- Do not allow water to enter this unit or allow the unit to become wet. Fire or electrical shock may result.
- Connect this unit's power cord only to an AC outlet of the type stated in this Owner's Manual or as marked on the unit. Failure to do so is a fire and electrical shock hazard.
- Do not scratch, bend, twist, pull, or heat the power cord. A damaged power cord is a fire and electrical shock hazard.
- Do not place heavy objects, including this unit, on top of the power cord. A damaged power cord is a fire and electrical shock hazard. In particular, be careful not to place heavy objects on a power cord covered by a carpet.
- If you notice any abnormality, such as smoke, odor, or noise, or if a foreign object or liquid gets inside the unit, turn it off immediately. Remove the power cord from the AC outlet. Consult your dealer for repair. Using the unit in this condition is a fire and electrical shock hazard.
- Should this unit be dropped or the cabinet be damaged, turn the power switch off, remove the power plug from the AC outlet, and contact your dealer. If you continue using the unit without heeding this instruction, fire or electrical shock may result.
- If the power cord is damaged (i.e., cut or a bare wire is exposed), ask your dealer for a replacement. Using the unit with a damaged power cord is a fire and electrical shock hazard.
- Do not modify the unit. Doing so is a fire and electrical shock hazard.

☐ Cautions

- When rack-mounting the unit, allow enough free space around the unit for normal ventilation. This should be: 10 cm at the sides, 20 cm behind, and 30 cm above.
For normal ventilation during use, remove the rear of the rack or open a ventilation hole.
If the airflow is not adequate, the unit will heat up inside and may cause a fire.
- This unit has ventilation holes at the bottom to prevent the internal temperature rising too high. Do not block them. Blocked ventilation holes are a fire hazard.
- Hold the power cord plug when disconnecting it from an AC outlet. Never pull the cord. A damaged power cord is a potential fire and electrical shock hazard.

- Do not touch the power plug with wet hands. Doing so is a potential electrical shock hazard.
- Use only the included power supply cable for this unit. Using other types may be a fire hazard.
- Always touch a well-grounded metal surface or the like to fully discharge any static electric charge on your body and clothing before handling an I/O card or hard disk.
Neglecting this precaution can cause damage to the unit from static electricity.
- Be careful not to touch the leads (metal feet) on the rear side when handling an I/O card or hard disk. Touching the leads can cause contact defects.

□ Operating Notes

- Using a mobile telephone near this unit may induce noise. If noise occurs, use the telephone away from the unit.
- XLR-type connectors are wired as follows: pin 1: ground, pin 2: hot (+), and pin 3: cold (-).
- Insert TRS phone jacks are wired as follows: sleeve: ground, tip: send, and ring: return.
- If the message “LOW BATTERY” appears when you turn on this unit, contact your dealer as soon as possible about replacing the internal data backup battery. The unit will still operate correctly, but data other than the presets will be lost.
We recommend that you save the data on CD-RW drive or external SCSI device before replacing the battery.
- The performance of components with moving contacts, such switches, rotary controls, faders, and connectors, deteriorates over time. The rate of deterioration depends on the operating environment and is unavoidable. Consult your dealer about replacing defective components.

Handling the CD-R/RW media

Please observe the following points when handling the disk.

Failure to do so may cause problems such as the recorded data being lost, the drive to malfunction, or the printed label to become blurred.

- Do not place the disk in locations of direct sunlight, high temperature, or high humidity.
- Do not touch either surface of the disk.
- Hold the disk at the edges. Gently wipe dust or dirt off of the recording surface of the disk.
- Do not wipe the disk with chemicals or detergents.
- Do not bend or drop the disk.
- Use an air duster or cleaner to remove dust. Vigorously rubbing the surface of the disk with a dry cloth may scratch the disk.
- Do not write on the disk or affix labels to it.

Storing produced data

Produced data can be lost due to breakdown or mistaken operation. We recommend that you store all important data on CD-R or CD-RW disks or other external storage medium.

Responsibility for loss of data, etc.

- Yamaha will accept no responsibility for any damages (including consequential or incidental) incurred by the customer or any third party as a result of loss or impairment of the data stored on the CD-R media, regardless of whether such loss could have been or actually was foreseen by Yamaha.
- Nor does Yamaha guarantee the media against any defect that may render it unusable.

Cautions for handling optional equipment

- For inquiries concerning I/O card, hard disk, or CD-RW drive handling, please consult your Yamaha dealer.
- Always switch off the power for the main unit and all peripherals, unplug the power cord for the main unit from the outlet, then disconnect the cables connecting the main unit with the peripherals before starting installation work.
- Wear thick gloves when working on this equipment to avoid cutting your hands on metal fittings or the like on the main unit, I/O card, hard disk, or CD-RW drive.
- Always touch a well-grounded metal surface or the like to fully discharge any static electric charge on your body and clothing before starting to work on this equipment.
- Take extreme care to avoid touching any terminals or board surface parts.
- In order to protect the electronic circuits of the I/O card, hard disk, CD-RW drive, etc. from damage due to static electricity, when handling any of this equipment, take the most extreme care to avoid touching IC leads or other electronic parts.
- Be careful not to drop any screws into the main unit. If you switch the power on with a dropped screw still in the main unit, the main unit may malfunction or break down. If a dropped screw can not be retrieved, consult your Yamaha dealer.
- If the hard disk or CD-RW drive breaks down, contact the store where you purchased that equipment.

Except for duplication for personal use or when there is no copyright problem, the duplication or transfer of commercially sold music/sound data without the permission of the copyright holder is prohibited. When using this equipment, please consult with a copyright specialist.

○ Warning

The Yamaha Professional Audio Workstation is designed to be used professionally and responsibly by recording industry professionals. The reproduction, distribution, or, in some instances, the public performance, of all or a portion of a sound recording or musical composition protected by copyright, without having obtained a proper license from the relevant copyright holders, may constitute copyright infringement and may otherwise violate copyright laws and other laws. In addition, laws (such as the Audio Home Recording Act and the Digital Millennium Copyright Act in USA) contain certain restrictions and requirements that may apply to your use of works protected by copyright and related information and data that may accompany such works. Violation of such laws may result in civil remedies and, in some cases, criminal liability.

Because violations of copyright laws may be serious offenses, you should consult a lawyer familiar with the law of copyright, including all laws that may be applicable to your use of the Workstation (such as the Audio Home Recording Act and the Digital Millennium Copyright Act in USA), if you have any questions regarding your intended use of all or parts of sound recordings or musical compositions protected by copyright.

Thank you for purchasing the Yamaha AW4416 audio workstation. In order to take full advantage of the AW4416's functionality and enjoy trouble-free operation, please carefully read the "Operation Guide" (this manual) and the separate "Reference Manual" and "Tutorial."

Table of contents

Before you begin	1
Checking the included items	1
Installing an internal hard disk	2
About the internal hard disk	2
Installation	3
Installing a CD-RW drive	5
About the CD-RW drives	5
The SCSI ID of the CD-RW drive	5
Installation procedure	6
Removing the transport protection pad	9
How to remove the transport protection pad	9
Manual eject (emergency disc removal)	10
Attaching an external SCSI device	10
About external SCSI devices	10
Connection procedure	11
About terminators	12
About SCSI errors	12
Installing I/O cards	13
About I/O cards	13
Installation procedure	14
Important points you must observe	15
Turning the power on or off	15
Turning the power on	15
Setting the internal clock	16
Turning the power off	17
Transporting the AW4416	18
Vibration during use	18
Chapter 1 Welcome to the world of the AW4416	19
Features of the AW4416	19
Mixer section	19
Recorder section	20
Sampling pad section	21

CD-RW drive (option)	21
Other features	21
Signal flow within the AW4416	22
Input patch	23
Input channels 1–24	24
Return channels 1/2	25
Recorder input patching	26
Monitor channels 1–16	26
Digital cascade connections	27
Oscillator	27
Stereo output channel	27
Buses 1–8	28
AUX buses 1–8	28
Output patch	29
Internal effects 1/2	29
Monitor output/headphone output	30
Chapter 2 Parts and their functions	31
Top panel	31
Analog input/output section	31
WORK NAVIGATE section	32
UNIT section	32
MIXER section	33
FADER MODE section	34
MIXING LAYER section	35
[SEL] keys, [ON] keys, faders	37
Display section	38
Level meter/counter section	39
RECORDER section	40
AUTOMATION section	41
SCENE MEMORY section	41
CURSOR/JOG & SHUTTLE section	42
Locate section	43
Transport section	44
SAMPLING PAD section	45
Rear panel	46
Front panel	50
Chapter 3 The user interface of the AW4416	51
Display	51
Level meters/counter	54
Basic operation of the AW4416	56
Accessing a screen/page	56
Using the controls of the top panel	56

Using the mouse	56
Turning a button on/off	57
Using the controls of the top panel	57
Using the mouse	57
Editing the value of a fader/knob/numerical box	58
Using the controls of the top panel	58
Using the mouse	58
Using the additional function buttons	59
Using the controls of the top panel	59
Using the mouse	59
Inputting text	60
Using the controls of the tab page	60
Using the mouse	62
Selecting channels	63
Chapter 4 Connections and setup	67
Connections	67
Word clock settings	68
Chapter 5 Recording on the AW4416	73
Preparations for recording	73
Connections and start-up	73
Creating a new song	75
Recording the first tracks	78
Set the input level	78
Assign the signals to buses	81
Set the tracks to record-ready mode	82
Make monitor settings	83
Let's record!	85
Overdubbing	87
Set the input level	87
Assign the signal to a bus	88
Put the track in record-ready mode	89
Make monitor settings	90
Using EQ and the dynamics processor	91
Using the four-band EQ	91
Using the dynamics processor	92
Let's overdub!	94
Mixdown	95
Creating the mix balance of the tracks	95
Using the Solo function	96
Using the internal effects	99
Other convenient functions	101
Fader groups	101
Mute groups	101
Automix	102

Recording the stereo track.	102
Saving a scene/song	105
Saving a scene	105
Saving a song	106
Chapter 6 Transport/locate operations.	109
Table of transport key operations	109
Shuttle function (cue/review operation).	110
Nudge function.	110
Using the Nudge function	110
Nudge function settings	112
Rollback function	113
Locating to a specific point.	114
Locating to the zero location of the counter.	115
Setting the zero relative time location	115
Locating to the start/end points	117
A-B repeat	118
Setting the A/B points	118
Performing A-B repeat playback	118
In/out points.	120
Setting the In point/Out point	120
Markers	121
Setting a marker	121
Locating to a marker	121
Adjusting the location of a locate point	123
Deleting a locate point	125
Deleting a locate point using the panel keys.	126
Deleting an In/Out point or A/B point	126
Deleting a marker	126
Chapter 7 Punch-in/out	127
About punch-in/out	127
Manual punch-in/out (→ P.128)	127
Auto punch-in/out (→ P.130).	127
Manual punch-in/out	128
Preparations	128
Make input monitor settings	128
Connect a foot switch	128
Manual punch-in/out recording	129
Auto punch-in/out	130
Preparations	130
Make input monitor settings	130
Set the auto punch-in/out points	130
Set the pre-roll/post-roll times	130
Rehearsing and recording with auto punch-in/out.	131
Rehearsing with auto punch-in/out	131
Recording with auto punch-in/out.	132

Chapter 8	Patching	133
	Patching to the input channels	133
	Patching to the recorder inputs	135
	Patching to the outputs	136
	Patch library	138
	Storing to the patch library	138
	Recalling a patch program	139
	Patching input/output jacks to an insert I/O point	140
	Using the Quick Rec function	143
Chapter 9	Track and virtual track operations	147
	The track structure of the AW4416	147
	Switching virtual tracks	149
	Pairing tracks	151
	Editing tracks and virtual tracks	152
	Tracks, parts, and regions	152
	Naming a virtual track or region	153
	Naming a virtual track	153
	Naming a region	155
	Track editing procedure	156
	Virtual track editing procedure	159
	Editing command list	161
	TRACK menu	161
	PART menu	162
	REGION menu	163
Chapter 10	Internal effects	165
	About the internal effects	165
	Using AUX send/return	165
	Inserting an effect into a channel	165
	Using AUX send/return to apply an effect	166
	Patching	166
	Recalling an effect program from the library	167
	Switching between pre-fader and post-fader	169
	Adjusting the send level/return level	170
	Adjusting the send level	170
	Inserting an effect into a desired channel	171
	Patching	171
	Inserting an effect into monitor channel 1	172
	Recalling an effect program	174
Chapter 11	Song management	175
	About songs	175
	Song structure and size	176
	Song structure	176

Usable hard disks/song capacity	176
Work area for audio CD production	176
Saving/loading a song	177
Saving the current song	177
Loading a song	178
Editing the song name/comment	179
Deleting/copying a song	180
Deleting a song	180
Copying a song	181
Optimizing a song	182
Importing mixer data of an existing song	183
Chapter 12 Sampling pads	185
About the sampling pads	185
Assigning the pad outputs to channels	186
Assigning a region to a sampling pad	187
Trimming a sample	190
Naming a pad	193
Erasing a pad sample and name	194
Recording your performance on the sampling pads	196
Copying a pad performance	198
Erasing a pad performance	201
Chapter 13 Scene memory	203
About scene memory	203
Parameters included in a scene	203
About scene numbers	203
Storing a scene	204
Recalling a scene	206
Editing the name of a scene	207
Protecting a scene	208
Changing the order of scenes	209
Using keys to store/recall a scene	211
Storing a scene	211
Recalling a scene	212
Chapter 14 Automix	213
What is automix?	213
Creating a new automix	214
Recording the first section	216
Playing back automix	218
Overwriting events	219
Automix punch-in/out	221

Editing the fader movements	223
Editing automix off-line	225
Storing an automix	228
Recalling an automix	230
Chapter 15 MIDI	231
What you can do using MIDI	231
MIDI connectors and the TO HOST connector	232
Using the TO HOST connector for direct connection to your computer	233
Connections	233
Setting the PORT SELECT parameter	234
Switching AW4416 scenes from an external device	235
Using MTC to synchronize the AW4416 and a MIDI sequencer . .	238
Using MIDI Clock to synchronize the AW4416 and a MIDI sequencer	240
Using MMC to control the AW4416	243
Chapter 16 Backing up and restoring songs	245
Selecting the backup format	245
Backing up a song	246
Restoring a song	248
Disk utilities	250
Formatting the internal hard disk/external SCSI device	250
Formatting the internal hard disk	251
Formatting an external hard disk	251
Formatting removable media such as an MO drive	253
Erasing CD-RW media	254
Chapter 17 Mastering	255
About mastering	255
Stereo tracks that can be mastered	255
CD-R and CD-RW	256
Track At Once and Disc At Once	257
Preparations for mastering	258
Mastering mode settings	258
Writing the master	259
Finalizing	263
Playing CD-R/RW media (the CD Play function)	264
Index	267

Before you begin

This chapter explains preparations you need to make before using the AW4416, such as checking the included items and installing options.

Checking the included items

Please make sure that the package contains the following items. If any items are missing, please contact your dealer.

- AW4416 mixer/recorder unit: 1
- Operation guide (this document): 1
- Reference guide: 1
- Tutorial: 1
- Power supply cable: 1
- CD-ROM: 1
- Red and white cable for CD-RW drive (four conductor): 1
- Screws for installing 2.5 inch hard disk/CD-RW drive: 8
- ADP25H 2.5 inch hard disk adapter: 1 (pre-installed in the 2.5" HARD DISK DRIVE slot on the rear panel of the AW4416)

○ Trademarks

ADAT MultiChannel Optical Digital Interface is a trademark and ADAT and Alesis are registered trademarks of Alesis Corporation. Apple and Macintosh are registered trademarks of Apple Computer, Inc. Tascam Digital Interface is a trademark and Tascam and Teac are registered trademarks of Teac Corporation. MS-DOS is a registered trademark and Windows is a trademark of Microsoft Corporation. Yamaha is a trademark of Yamaha Corporation. All other trademarks are the property of their respective holders and are hereby acknowledged.

○ Copyright

No part of the AW4416 software or the manuals may be reproduced or distributed in any form or by any means without the prior written authorization of Yamaha Corporation.

© 2000 Yamaha Corporation. All rights reserved.

○ Yamaha website

<<http://www.yamaha.co.jp/product/proaudio/homeenglish/>>

Installing an internal hard disk

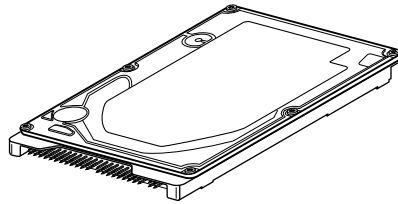

You must install a hard disk in the AW4416 before using it. If you attempt to use the AW4416 without installing a hard disk, the recorder section and mixer section will fail to operate correctly, and the AW4416 will be damaged as well.

About the internal hard disk

On the AW4416, all data necessary for reproducing a composition (mixer settings, recorder settings, audio data etc.) is stored on the hard disk as a “song.”

An internal hard disk is attached to the ADP25H 2.5 inch hard disk adapter and installed in the 2.5" HARD DISK DRIVE slot located on the rear panel. Hard disks with the following specifications can be used.

- Type: IDE 2.5 inch (attachment location conforms to SFF-8201)
- Thickness: no particular limitation
- Capacity: no particular limitation (however, the AW4416 can use a maximum capacity of 64 GB)
- Models known to work: consult your local Yamaha distributor or refer to the website at the following URL.
<<http://www.aw4416.com/>>



-
- *By “models known to work,” we mean commercially available models that Yamaha has obtained, installed in the AW4416, and successfully tested by means of various operational tests. However, we cannot take into account slight differences in performance that may occur due to the manufacturing tolerances of each manufacturer.*
 - *Hard disks are precision devices. Strong physical shock, magnetism, static electricity, or excessive current etc. can damage the data on a hard disk. You must use media such as an external SCSI device or CD-RW to backup your important musical data.*
 - *Please be aware that Yamaha Corporation will accept no responsibility for any damages, neither direct nor indirect, resulting from the use of any of the above hard disks.*

Installation

Please read and observe the cautions on installing optional equipment listed at the beginning of this manual.

Here's how to attach a 2.5 inch IDE hard disk to the ADP25H hard disk adapter included with the AW4416, and install it into the appropriate slot of the AW4416.



- *Hard disks are precision devices. Do not subject them to physical shock or static electricity, etc.*
- *Do not place a hard disk nearby devices that produce a strong magnetic field, or in locations of extreme cold, heat, or moisture.*
- *Before you handle a hard disk, touch your hand to a grounded metallic object to release any static charge that may be present in your body or clothing. If you fail to do so, static electricity may damage the hard disk.*
- *Never attempt to disassemble a hard disk or apply excessive force to it.*
- *The AW4416 is shipped with four screws for attaching a 2.5 inch hard disk, and four screws for attaching a CD-RW drive, making a total of eight included screws of the same type.*

1. You will need the following items.
 - The AW4416 itself
 - A 2.5 inch IDE hard disk (sold separately) for installation
 - Four screws included with the AW4416 for attaching the 2.5 inch hard disk
 - A philips (+) screwdriver
2. Make sure that the power of the AW4416 is turned off. For safety's sake, disconnect the power cable from the AC outlet.
3. On the rear panel of the AW4416, remove the two screws that hold the ADP25H 2.5 inch hard disk adapter to the 2.5" HARD DISK DRIVE slot.

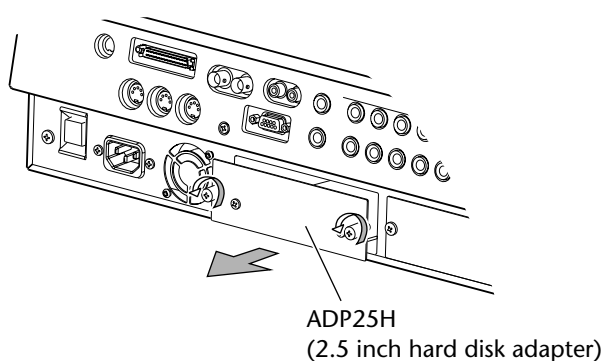

- Place the hard disk on the ADP25H as shown in the diagram below, align the screw holes of the hard disk and the ADP25H, and use your screwdriver to fasten the screws at the four locations shown.

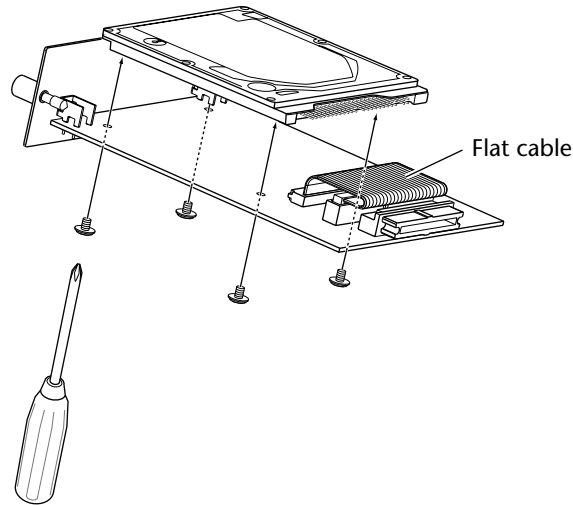

- Plug the connector of the flat cable extending from the ADP25H into the connector of the hard disk.

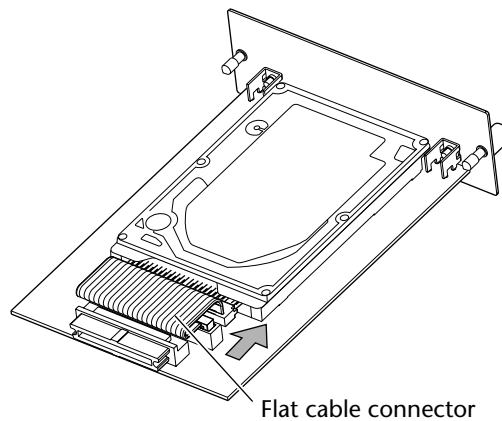

- Even if it is difficult to plug in the connector, do not use excessive pressure to force it in. This may damage the hard disk, or you may injure yourself.

- Aligning the ADP25H (with the hard disk attached) with the rails inside the 2.5" HARD DISK DRIVE slot, push it in until it clicks into place.
- Use the screws that you removed in step 3 to fasten the ADP25H into the 2.5" HARD DISK DRIVE slot.



- If you fail to tighten the screws all the way, the hard disk may vibrate and fail to operate correctly.



- Do not turn on the power of the AW4416 until all options have been installed.
- When you turn on the power of the AW4416 after installing a new hard disk, formatting of the hard disk will begin automatically (→ P.15).

Installing a CD-RW drive

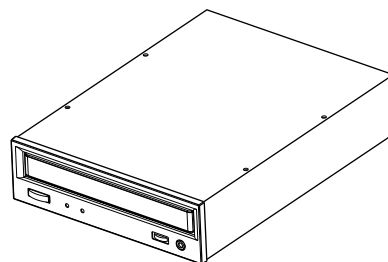

About the CD-RW drives

A CD-RW drive is an option that allows you to create music CD's, to backup/restore internal hard disk data, to play a music CD or to read a CD-ROM. An internal-type CD-RW drive can be installed by removing the CD-RW drive cover from the front panel. CD-RW drives with the following specifications can be used.

- Interface: SCSI-2
- Models known to work: consult your local Yamaha distributor or refer to the website at the following URL.
<<http://www.aw4416.com/>>



- *By "models known to work," we mean commercially available models that Yamaha has obtained, installed in the AW4416, and successfully tested by means of various operational tests. However, we cannot take into account slight differences in performance that may occur due to the manufacturing tolerances of each manufacturer.*
- *Please be aware that Yamaha Corporation will accept no responsibility for any damages, neither direct nor indirect, resulting from the use of any of the above CD-RW drives.*

- * Note that the cover panel of the AW4416 cannot be attached to a CD-RW drive with a lid-type tray. The AW4416's cover panel can be attached to a CD-RW drive with a tray of the following dimensions.

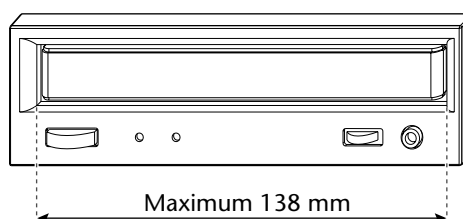

□ The SCSI ID of the CD-RW drive

- The SCSI ID of the AW4416 itself is fixed at "6." For this reason, you must set the SCSI ID of the CD-RW drive to "6" before installing it.

- In the various screens of the AW4416, the SCSI ID of the internal CD-RW drive has been set to “3” by default. For this reason, you will find it convenient to set the ID of the CD-RW to “3.” (For details on setting the SCSI ID, refer to the manual for your CD-RW drive.)
- If you are installing a CD-RW drive manufactured by Yamaha, the SCSI ID will be set to “3” at the factory, and we recommend that you leave it at this setting.

Installation procedure

Please carefully read the cautions for installing optional equipment given at the beginning of this manual.

1. You will need the following items.

- The AW4416 itself
- Internal CD-RW drive (option)
- Screws (included with the AW4416) for attaching the CD-RW drive
- Red and white cable for CD-RW drive (four conductor)
- Philips (+) screwdriver
- Work surface



-
- *In order to install the CD-RW drive you will need to turn the AW4416 on its back. Make sure that you have a sufficiently broad work surface.*
 - *The AW4416 is shipped with four screws for attaching the 2.5 inch hard disk, and four screws for attaching the CD-RW drive, making a total of eight screws of the same type.*

2. Make sure that the power of the AW4416 is turned off. For safety's sake, disconnect the power cable from the AC outlet.

3. Turn the AW4416 upside down on the work surface.

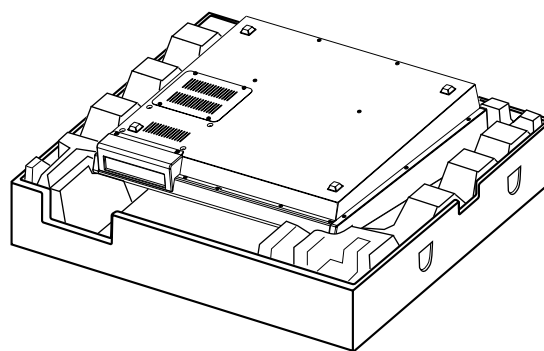

.....

When turning the AW4416 upside down, we recommend that you use the packing foam from the AW4416's shipping carton as shown in the diagram at above, so that the controls of the top panel are not damaged. If the packing foam is not available, please spread out a soft cloth, and support each of the four corners of the AW4416 with a stack of magazines etc.

4. Remove the CD-RW drive cover from the front panel, and remove the bottom panel.

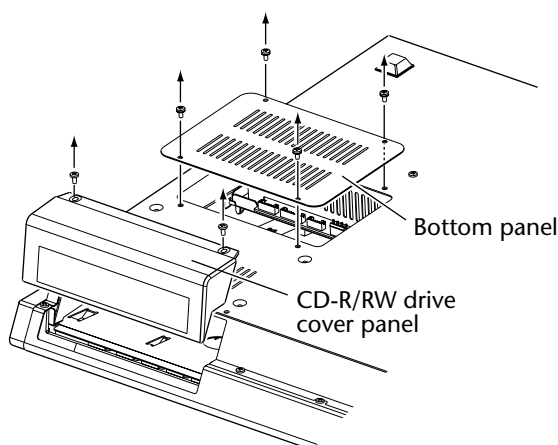

5. Turn the CD-RW drive over, and insert it little by little, stopping when the connector end of the CD-RW drive enters the opening in the bottom of the AW4416.

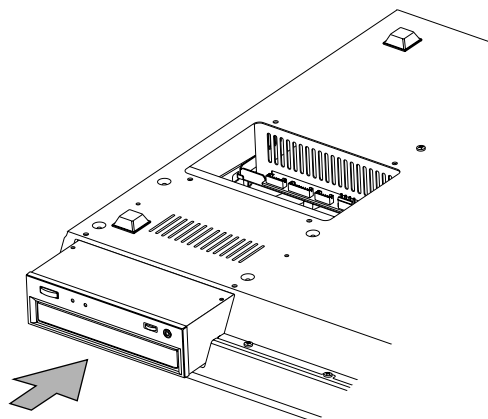

6. Connect the red and white four-conductor cable included with the AW4416 to the internal connector of the AW4416 as shown in the diagram. Then connect the cable to the connector of the CD-RW drive.

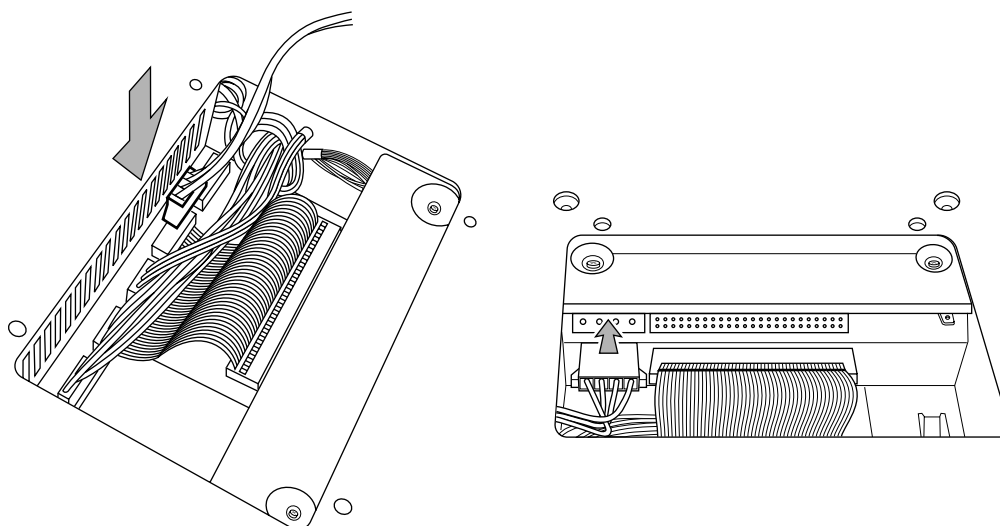

7. Plug the connector of the flat cable (extending from inside the AW4416) into the connector of the CD-RW drive.

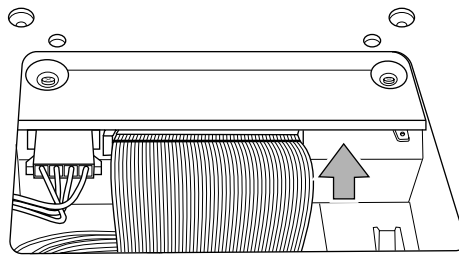

8. Align the screw holes in the bottom of the CD-RW drive with the screw holes of the AW4416, and use a screwdriver to fasten the drive with the four included screws.

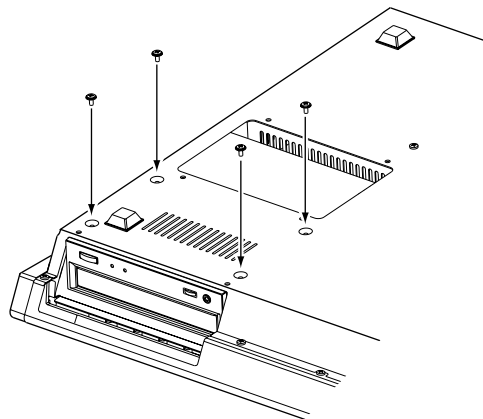

9. Re-attach the CD-RW drive cover and the bottom panel that you removed in step 3. At this time, remove the inner cover from the CD-RW drive cover.

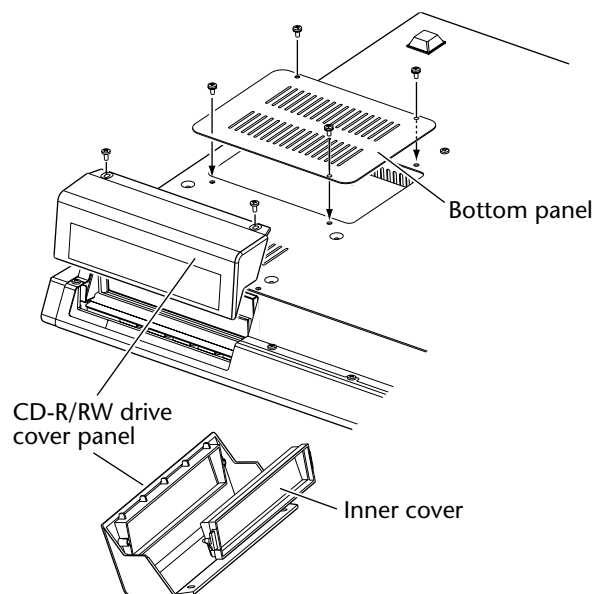

Removing the transport protection pad

When CD-RW drives are shipped, the disc tray contains a transport protection pad that protects the internal mechanism from physical shock suffered during shipment. Please remove this protective pad before use.

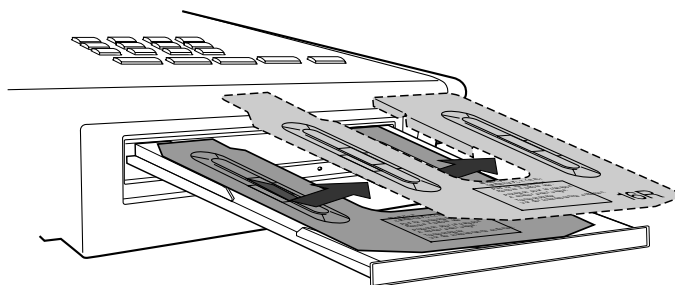

* This diagram shows a CD-RW drive manufactured by Yamaha Corporation.



.....
Be sure to save the transport protection pad for the next time you need to transport the unit.

How to remove the transport protection pad

1. Install the CD-RW drive in the AW4416.
2. Turn on the power of the AW4416.
Set the SCSI ID number as necessary (→ P.259).
3. Press the [CD PLAY] key, and then press the [SHIFT] + [F2] keys to open the disc tray.
4. Remove the transport protection pad.
Before transporting the unit, reverse this procedure to insert the pad.

Manual eject (emergency disc removal)

Manual eject allows you to remove the disc manually in the case of an emergency such as a malfunction of the disc tray mechanism (usually temporary) or a power failure. Please be aware that using this method frequently can cause the CD-RW drive to malfunction. For the location of the eject hole and the procedure, refer to the manual of your CD-RW drive.

In order to perform this operation, you will need a pin-like object 2 mm or less in diameter, such as a straightened paper clip.

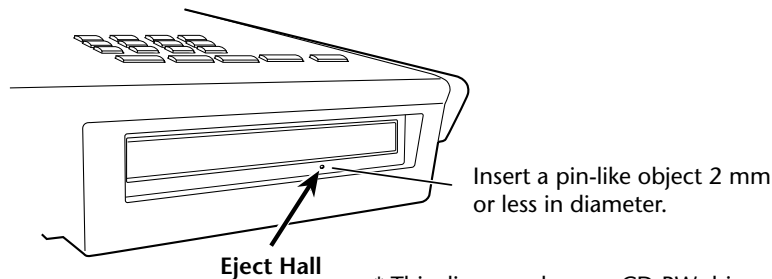

* This diagram shows a CD-RW drive manufactured by Yamaha Corporation.

Attaching an external SCSI device

About external SCSI devices

The external SCSI devices referred to here are storage devices used to backup/restore the internal data of the AW4416, and can be connected to the SCSI connector on the rear panel of the AW4416. The following types of storage device can be used.

- Type of drive: MO drives (128 MB, 230 MB, 540MB, 640 MB 1.3 GB), hard disk drives, CD-RW drives
- Interface: SCSI-2
- Models known to work: consult your local Yamaha distributor or refer to the website at the following URL.
<<http://www.aw4416.com/>>



- *By “models known to work,” we mean commercially available models that Yamaha has obtained, connected to the AW4416, and successfully tested by means of various operational tests. However, we cannot take into account slight differences in performance that may occur due to the manufacturing tolerances of each manufacturer.*
- *Please be aware that Yamaha Corporation will accept no responsibility for any damages, neither direct nor indirect, resulting from the use of any of the above storage devices.*



It is not possible to directly record or play back audio signals in realtime on an external storage device connected to the SCSI connector.

Connection procedure

1. Make sure that the power is turned off for the AW4416 and for the external SCSI device(s), and use a SCSI cable to connect the SCSI connectors of each device.

When connecting an external SCSI device, use only high impedance SCSI cables of 100 ohms (± 10 ohms) impedance that are 1 meter or shorter in length.



Use only good-quality SCSI cables.

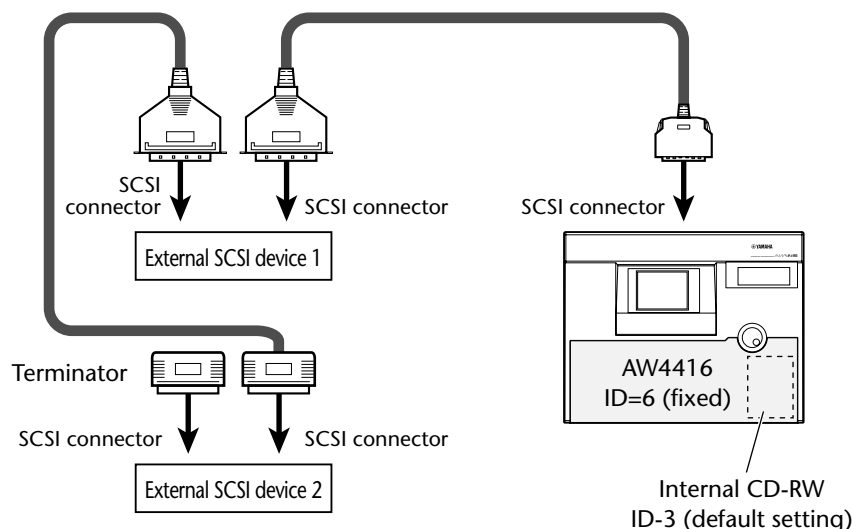

- A maximum of seven SCSI devices (SCSI ID= 0–5,7) can be connected in a daisy-chain (including the internal CD-RW drive).
- When connecting multiple SCSI devices, you must make sure that the SCSI ID of each device (including the internal CD-RW drive) does not conflict with any other device. (For details on how to set the SCSI ID, refer to the manuals for your SCSI devices.)
- The SCSI ID of the AW4416 itself is fixed at “6.”
- In the various screens of the AW4416, the SCSI ID of the internal CD-RW drive has been set to “3” by default. For this reason, if you install a CD-RW drive, you will find it convenient to set its ID to “3.” (For details on setting the SCSI ID, refer to the manual for your CD-RW drive.)
- If you install a CD-RW drive manufactured by Yamaha, the SCSI ID will be set to “3” at the factory, and we recommend that you leave it at this setting.

2. Attach a terminator to the last SCSI device in the chain.

A “terminator” is a device that terminates the SCSI signal at the end of the chain, and is normally attached to the vacant SCSI connector of the last device in the daisy chain. If the SCSI device has an active terminator (a circuit that terminates the signal electrically), turn it on. (For details of how to turn on the active terminator, refer to the manual of your SCSI device.)



Before using an external SCSI device, you will need to format it. For details on this procedure, refer to page 250.

□ About terminators

“Termination” refers to the process of applying a resistor appropriate for the impedance of the SCSI bus to terminate the end of the circuit. The resistor required for this is called the “terminator.” Normally, a terminator must be installed at the beginning and end of the SCSI bus (in the case of the example shown above, this would be the AW4416 itself, and the SCSI device connected to the end of the daisy chain).

However, this is only a general principle, and is not an absolute. Depending on the combination of SCSI devices, the order of connection, or on the length of the SCSI cables, there may be cases in which better results are obtained by terminating only one end of the chain. If problems occur such as the AW4416 failing to start up when an external SCSI device is connected, try defeating one of the terminators. (For details on how to defeat the internal terminator of the AW4416, refer to “UTILITY screen → Prefer. 3 page” in the Reference Guide.)

□ About SCSI errors

The SCSI bus is able to transfer data in a stable manner only if all connected SCSI devices are operating correctly. If the SCSI bus of the AW4416 is connected to a device whose operation is unstable or which produces noise, errors may occur in other devices, or the AW4416 may fail to start up correctly. If such problems occur, check the following points.

○ Check the SCSI ID

Make sure that the SCSI ID of each SCSI device (including the AW4416 and the internal CD-RW drive) does not conflict with the SCSI ID of any other device. The SCSI ID of the AW4416 is fixed at “6.”

○ Check the terminator

Check the location of the terminator. Under certain conditions, better results may be obtained by terminating only one end of the SCSI chain.

○ Check the SCSI cables

Since errors are often caused by low-quality SCSI cables or unnecessarily long SCSI cables, you should avoid using such cables. Please use double-shielded cables that are as short as possible. It is also important that the shield within the cable is grounded to the connector.

○ External SCSI devices with 25-pin connectors

Most SCSI cables with 25-pin connectors at both ends do not meet SCSI specifications. For this reason if the system includes a SCSI device that uses a 25-pin connector, the problems may be due to this type of cable.

Installing I/O cards

About I/O cards

I/O cards compatible with the Yamaha mini-YGDAI format can be installed in the OPTION I/O slots 1/2 located on the rear panel of the AW4416 in order to add input/output ports. For example by installing an ADAT format compatible I/O card into an OPTION I/O slot, you can transmit/receive eight channels of digital audio to/from an ADAT format digital recorder.

At present, the following types of I/O cards can be used.

○ **MY8-AT**

This card transmits and receives eight channels of Alesis ADAT format digital signals.

○ **MY8-TD**

This card transmits and receives eight channels of TASCAM format digital signals.

○ **MY8-AE**

This card transmits and receives eight channels of AES/EBU format digital signals.

○ **MY8-AD**

This is an A/D card with eight channels of analog input jacks (balanced TRS phone jacks).

○ **MY4-AD**

This is an A/D card with four channels of analog input jacks (balanced XLR jacks).

○ **MY4-DA**

This is a D/A card with four channels of analog output jacks (balanced XLR jacks).

For up-to-date information on available MY cards, contact your local Yamaha distributor or check the following website.

<<http://www.aw4416.com/>>



.....
Some types of MY card sold by other manufacturers may be usable only in SLOT 1 or 2.

Installation procedure

Please carefully read the cautions for installing optional devices, given at the beginning of this manual.

1. Make sure that the power of the AW4416 is turned off. For safety's sake, disconnect the power cable from the AC outlet.
2. From the OPTION I/O slot located on the rear panel of the AW4416, remove the two screws that hold the cover in place.

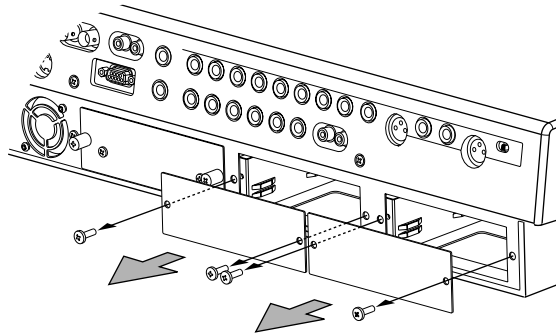

.....
Please keep the cover and screws you removed in a safe place.

3. Slide the I/O card along the rails inside the slot until it clicks into place.
4. Tighten the two screws included with the I/O card to fasten the card securely.

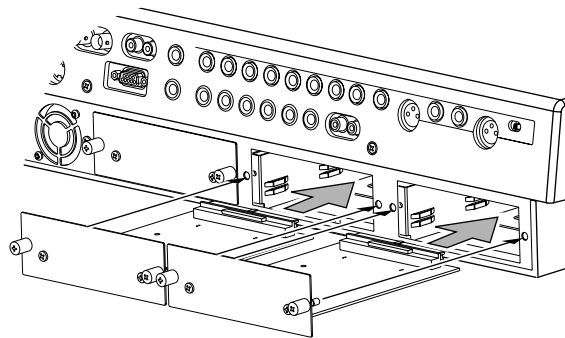

.....
Please note that if the screws are loose, the card may not be grounded correctly.

Important points you must observe

Turning the power on or off

You must use the following procedure to turn the power of the AW4416 on or off.

□ Turning the power on

To turn on the power of a system that includes the AW4416, you must turn on the power switches in the following order.

- ① Storage devices connected to the AW4416's SCSI connector, and external sound sources connected to the input/output jacks
- ② The AW4416 itself
- ③ The monitor system connected to the output jacks of the AW4416



.....
If the SCSI device is turned on after the AW4416 is turned on, it will not function correctly.

After the opening screen appears in the display of the AW4416, a TRACK screen like the following will appear.

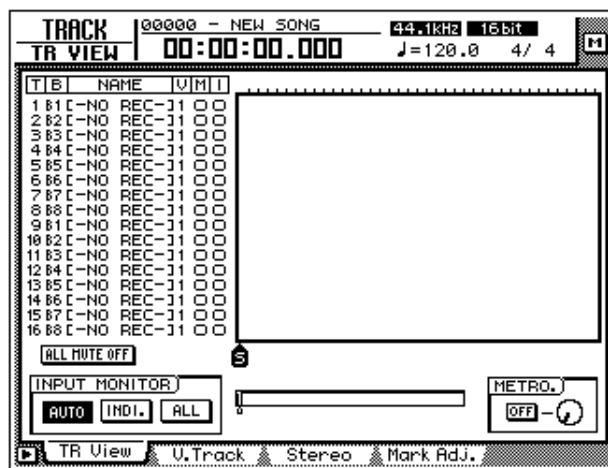

When the AW4416 is first turned on after a new internal hard disk has been installed, the display will ask "Format OK? [Y (Enter)/N (Any)]." If you now press the [ENTER] key, formatting of the hard disk will begin automatically. When formatting is completed, the screen shown above will appear.



.....
Never turn off the power of the AW4416 while formatting is in progress. Doing so may damage the hard disk itself.

Setting the internal clock

When the AW4416 is shipped from the factory, its internal clock is set to Japan time. When you create a song on the AW4416, the song will store the date and time using this internal time.

If it becomes necessary to reset the internal clock after replacing a run-down battery or for any other reason, use the following procedure.

1. Press the [UTILITY] key → [F4] key.
The UTILITY screen Prefer.3 page will appear.

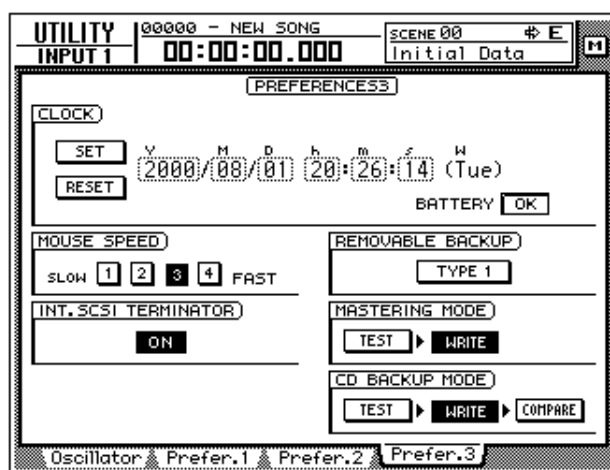

Use the CURSOR [▶] key to move the cursor to the square frame of the Y (year) field in the CLOCK area, and use the [DATA/JOG] dial to input the year. In the same way, input M (month), D (date), h (hour), m (minute), and s (second). (W is the day of the week, and will be set automatically.)

The time you specified will blink. Move the cursor to the SET button to confirm the setting, or to the RESET button to cancel, and then press the [ENTER] key. The internal clock of the AW4416 will be set to the specified time. If you select the RESET button and press the [ENTER] key, the clock will return to the previous state.

□ Turning the power off

To turn off the power of a system that includes the AW4416, you must turn off the power switches in the following order.

- ① The monitor system connected to the output jacks of the AW4416
- ② The AW4416 itself
- ③ Storage devices connected to the AW4416's SCSI connector, and external sound sources connected to the input/output jacks

Before turning off the power of the AW4416 itself, you must perform the following shut-down procedure.

○ Shut-down operation

1. In the WORK NAVIGATE section located in the upper left of the AW4416's top panel, press the [SONG] key.
2. Below the display, press the [F5] (Shut Down) key.
3. The CURRENT SONG STATUS screen will appear, allowing you to check the content of the last-saved song.

The data for the current song (date, size, quantization bits, protect) shown here in the song list is the data for when the song was last saved. When you perform the following Save procedure and press the [ENTER] key, it will be overwritten by the new data.

Move the cursor to the EXECUTE button and press the [ENTER] key.

A message will ask you whether you wish to save the current song.



4. Use the CURSOR [◀]/[▶]/[▲]/[▼] keys in the center right of the top panel to move the cursor (the blinking rectangle) to the OK button, and press the [ENTER] key located immediately below.
5. When the "Now safe to turn off" message appears, turn off the [POWER] switch located on the rear panel.



- If you turn off the power of the AW4416 without performing the shut-down procedure described at the above, the audio data on the hard disk may be lost.
- Never turn off the power while the access indicator in the level meter/counter is lit, since this may damage the hard disk itself.
- If lightning is occurring nearby, disconnect the power cable from the AC outlet. The AW4416 can be damaged by lightning.

Transporting the AW4416

When transporting the AW4416, you must disconnect all cables, and pack it in the packing foam in which the unit was shipped (or the equivalent). If a CD-RW drive (option) is installed, insert the protective pad that was included with it into the drive.



- *If you transport the AW4416 without packing it as described at the above, any damage or malfunctions that occur during transport may not be covered under warranty.*
- *Even if the AW4416 is packed as described at the above, any damage or malfunctions that occur due to dropping the unit etc. may not be covered under warranty. Please handle the AW4416 with care.*

Vibration during use

The internal hard disk or CD-RW drive of the AW4416 are very sensitive to vibration. Do not allow them to be subject to vibration or shock during operation, and do not move the AW4416 while its power is turned on.

In particular, you must never apply physical shock or vibration while the access indicator of the level meter/counter is lit, since this may damage the hard disk itself.

1

Welcome to the world of the AW4416

This chapter explains the features and basic concepts of the AW4416, and outlines the signal flow.

Features of the AW4416

The AW4416 is an audio workstation that combines a digital mixer, hard disk recorder, multi-effects, and sampling pads. It is the only equipment you need to perform the entire music production process, from multi-track recording, mixing, audio editing, effect processing, and creating a final CD^(*1). In the following pages of this manual, the functionality of each section is described separately.

*1. An optional internal/external CD-RW drive is required.

□ Mixer section

○ Professional-quality audio with 32 bit internal processing

The AW4416 carries on the technology made famous on the de-facto standard for digital consoles — the Yamaha 02R. Internal processing is performed with 32 bit precision (54 bit precision for EQ) to guarantee the highest possible audio quality.

○ Up to 44 input channels and 20 buses, rivaling even large consoles

A total of 44 mixing inputs are provided, with 8 analog inputs, digital stereo input, 16 (maximum) digital/analog inputs via the OPTION I/O slot, in addition to 16 recorder monitor channels, and 2 return channels. Output buses total 20, with 8 group buses, 8 AUX buses, stereo bus, and SOLO bus (stereo). With a bus configuration that rivals large consoles, the AW4416 can handle a wide variety of applications.

○ Four-band EQ and dynamics processing on each channel

Every input as well as the stereo output channel provides the same powerful four-band full-parametric EQ and dynamics processor as on the 02R. (The two return channels are excepted.)

Each band of the EQ is fully adjustable in the range of ± 18 dB/f= 20 Hz–20 kHz/ Q= 41 points. The dynamics processor provides compressor, gate, ducking, expander, and compander functionality. Key-in and stereo link are also supported for precise control of the input signals.

○ Two high-quality multi-effect processors are built-in

Two multi-effect processors provide spatial effects such as reverb and delay, modulation effects such as chorus and flanger, and guitar effects such as distortion and amp simulator.

In addition to using these via the AUX bus send/return, they can be inserted into a channel or the stereo bus. A high-impedance jack for direct connection of an electric guitar is also provided.

○ Scenes and libraries

Faders locations and mix parameters for each channel, together with effect settings, can be stored as a scene.

Up to 96 scenes can be used for each song. Scenes that you save can be recalled instantly using the top panel keys, or by transmitting program change messages from an external MIDI device. Libraries for storing EQ, dynamics processor, and channel settings are also provided.

○ Full mixing automation

The AW4416 features seventeen 60 mm motorized faders.

In addition to the ability to recall scene memories and libraries, the AW4416 provides fully automated mixing that records fader/pan/EQ movements in realtime.

□ Recorder section

○ High capacity hard disk up to 64 GB^(*2)

An internal hard disk (2.5 inch IDE type) of up to 64 GB (maximum 6.4 GB per song) is supported.

A hard disk attached to the ADP25H cartridge (sold separately) can be inserted into the hard disk slot of the AW4416, allowing you to exchange hard disks as easily and conveniently as if you were using removable media.

*2. Hard disks are sold separately.

○ Efficient data management

All of the audio data (multi-track and stereo track), scene memories, libraries, and automix data used in a song are managed on the internal hard disk as a “Song.”

A desired song can be recalled from disk at any time. Songs can also be backed up on an external hard disk, MO disk, or CD-R/RW disc.

○ 16×8 virtual tracks + stereo track

A single song consists of 16 tracks × 8 virtual tracks + stereo track (total of 130 tracks).

The quantization (16 bit/24 bit) and sampling frequency (44.1 kHz/48 kHz) can be selected for each song. 16 tracks can be recorded simultaneously, or 16 tracks played back while recording 8 tracks simultaneously, making the AW4416 an ideal choice for live recording or for re-recording or ping-ponging from an external recorder. The 16 tracks can also be mixed down directly to the stereo track. This has the advantage not only of making a master recorder unnecessary, but also of allowing multi-track and two-track mix data to be managed together.

○ Versatile editing functionality

Data can be edited freely at every level — song, track, part, and region.

Editing functions include “time compression” that allows you to compress or expand time over a range of 50%–200%, and “pitch change” that can modify the pitch as far as an octave upward or downward. Editing is non-destructive, allowing up to fifteen levels of undo/redo.

○ Locate functions, and auto punch-in/out

A total of eight locate keys are provided: start, end, RTZ, A, B, in, out, and roll-back. In addition, you can set 99 markers for each song, making it fast and easy to locate to any desired point. Auto punch-in/out at the specified punch-in and punch-out points is also provided. The AW4416 also has a built-in click metronome linked with the tempo map.

□ Sampling pad section

○ Assign 16 sounds to the sampling pads

Sixteen sounds can be assigned to the eight pads with switchable A/B banks.

Sounds can be sampled into these pads at the same 16 bit/24 bit and 44.1 kHz/48 kHz audio quality as for recording. Sampling sources can be taken from a sound file on hard disk, an audio CD inserted in the CD-RW drive, or from a WAV file on a SCSI device. The playback timing can be recorded on a special sequencer track, and edited later. Pad polyphony is eight notes, and a total of approximately 90 seconds can be sampled in the pads (16 bit/44.1 kHz).

□ CD-RW drive (option)

○ CD-RW drive^(*3) can be installed internally

You can produce an audio CD off-line, using stereo tracks from the hard disk. This allows entire process from recording to CD production to be completed within a single unit. The CD-RW drive can also be used to store recorded data, making backups easy. Playback of audio CD's and loading from CD-ROM is also supported, allowing these to be used as sources for the sampling pads.

*3. A CD-RW drive is optional.

□ Other features

○ Simple panel layout and efficient operation

The AW4416 features a large backlit LCD and a three-color FL display, providing a graphic user interface that can be used intuitively and efficiently. A serial mouse (9 pin D-sub connector) can also be connected.

○ Two I/O card option slots

Two slots support a variety of formats including ADAT, TASCAM, AES/EBU, and analog. The AW4416 is designed with an open architecture for superb expandability.

○ Sophisticated connectivity

TO HOST connector and SCSI connector (SCSI-2) are standard, ensuring easy connection to computers, external SCSI devices^(*4), and MIDI devices. WORD CLOCK IN/OUT connectors are also provided to allow the construction of digital systems for a variety of applications. In addition, MTC/MIDI clock can be used for synchronization, and MMC commands can control the AW4416 from an external device.

*4. External SCSI devices can be used only to back up data. They cannot be used to record audio data directly.

Signal flow within the AW4416

The following diagram shows the general signal flow of the AW4416. As you can see from this diagram, the AW4416 consists of several sections: input patch, output patch, mixer, sampling pads, recorder, and CD-RW drive (optional).

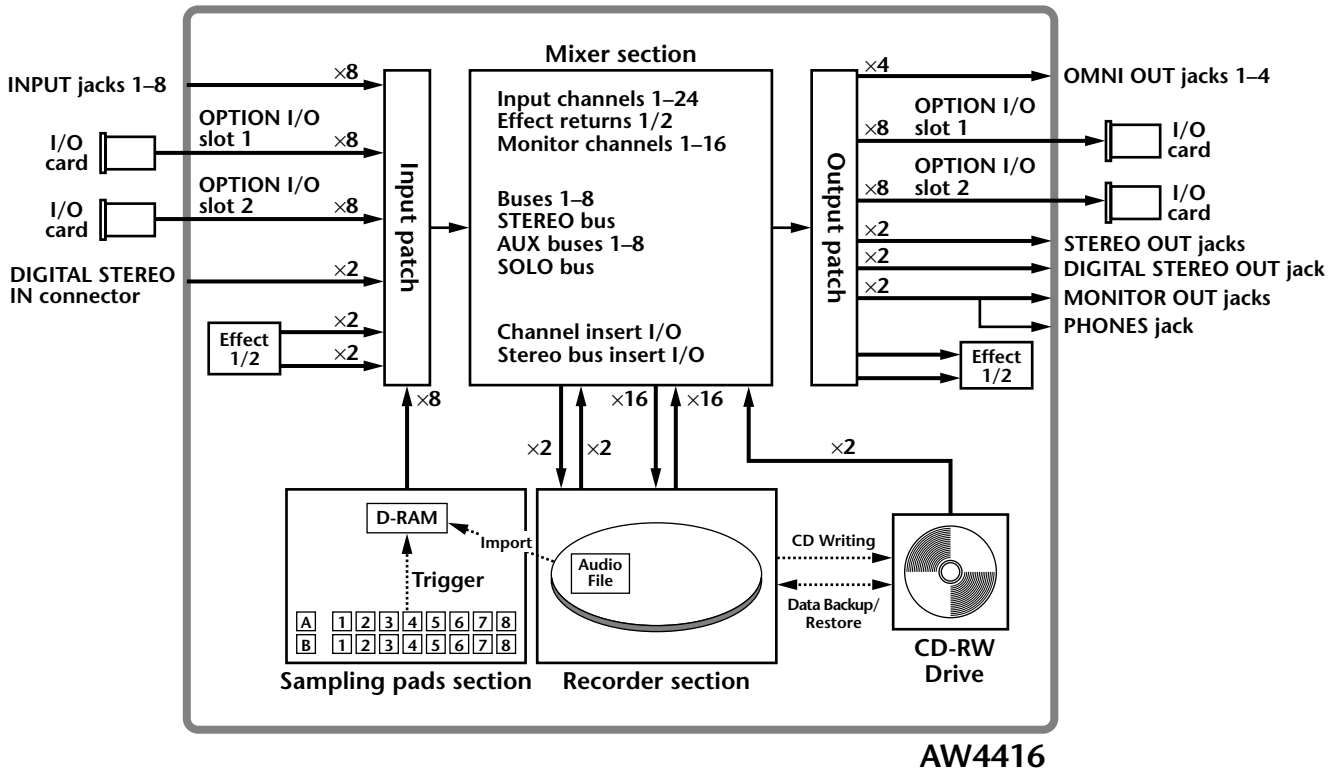

The signal flow within each section is explained in detail in the pages that follow.

Input patch

The input patch section is where input signals are assigned to input channels 1–24 and return channels 1/2. The following types of input signal can be selected.

MIC/LINE INPUT

Input signals from analog INPUT jacks 1–8.

OPTION IN

Input signals from an I/O card installed in rear panel OPTION I/O slots 1/2. Up to 8 channels of signal can be input simultaneously from a single I/O card.

SAMPLING PAD

Output signals of pads 1–8 in the sampling pad section.

EFFECT 1/2

Return signals from internal effects 1/2.

DIGITAL STEREO IN

Input signals from the DIGITAL STEREO IN jack.

METRONOME

The playback of the internal metronome.

The following input signals can be assigned to each channel.

	Input channel 1–24 (mono)	Return channel 1 (stereo)	Return channel 2 (stereo)
MIC/LINE INPUT	<input type="radio"/>	<input type="radio"/>	<input type="radio"/>
OPTION IN	<input type="radio"/>	<input type="radio"/>	<input type="radio"/>
SAMPLING PAD	<input type="radio"/>		
EFFECT 1		<input type="radio"/>	
EFFECT 2			<input type="radio"/>
DIGITAL STEREO IN	<input type="radio"/>	<input type="radio"/>	<input type="radio"/>
METRONOME	<input type="radio"/>		

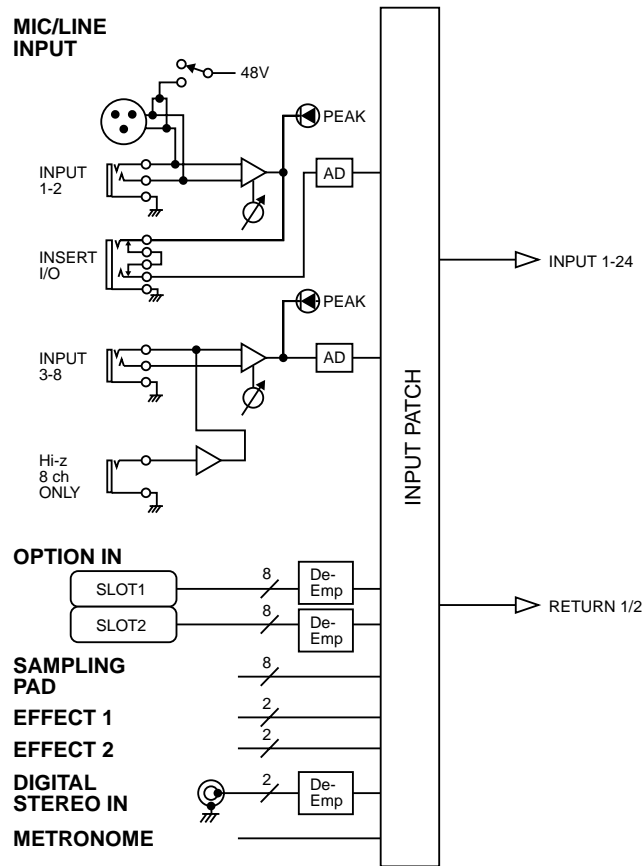

Input channels 1–24

There are monaural input channels used mainly for inputting mics or line level instruments. The signals input to input channels 1–24 are routed through an attenuator, phase switch, four-band EQ, dynamics processor, and delay, and are sent to buses 1–8, the stereo bus, or AUX buses 1–8. Input channels 1–16 have a direct output (DIRECT OUT) function that allows their signal to be output directly to an output jack or to the recorder section.

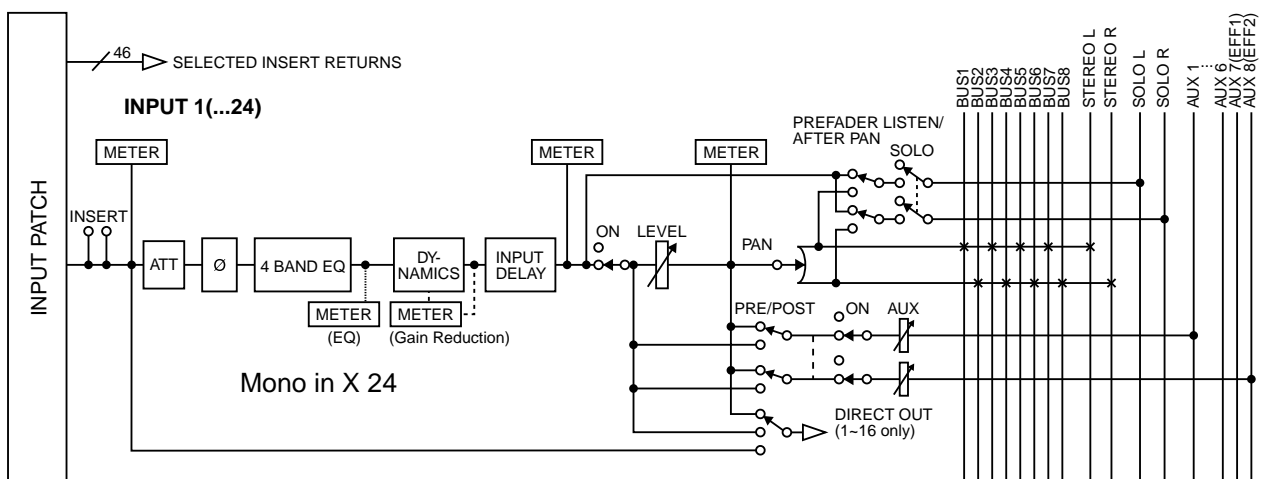

Return channels 1/2

These are stereo input channels used mainly to input the return signals from internal effects 1/2. However they can also be used as supplementary input channels by changing the input signal assignments of the input patch section.

The structure of these channels is identical to that of the input channels, with the exception of the following differences:

- ① **Stereo**
- ② **No dynamics processor**
- ③ **No direct output**
- ④ **No AUX 7 send level from return channel 1**
- ⑤ **No AUX 8 send level from return channel 2**



Since return channels 1/2 are stereo, selecting MIC/LINE INPUT or OPTION IN as input signals will cause two adjacent odd-numbered/even-numbered signals to be assigned. Also if DIGITAL STEREO IN is selected, the signals of both L/R will be assigned.



- The reason that return channel 1 (2) has no send level to AUX 7 (8) is to prevent the feedback loop that would occur if the signal returned from internal effect 1 (2) were sent back to the same internal effect.
- Be aware that the AUX 7 (8) send level is not available even if a different input signal is assigned to return channel 1 (2).

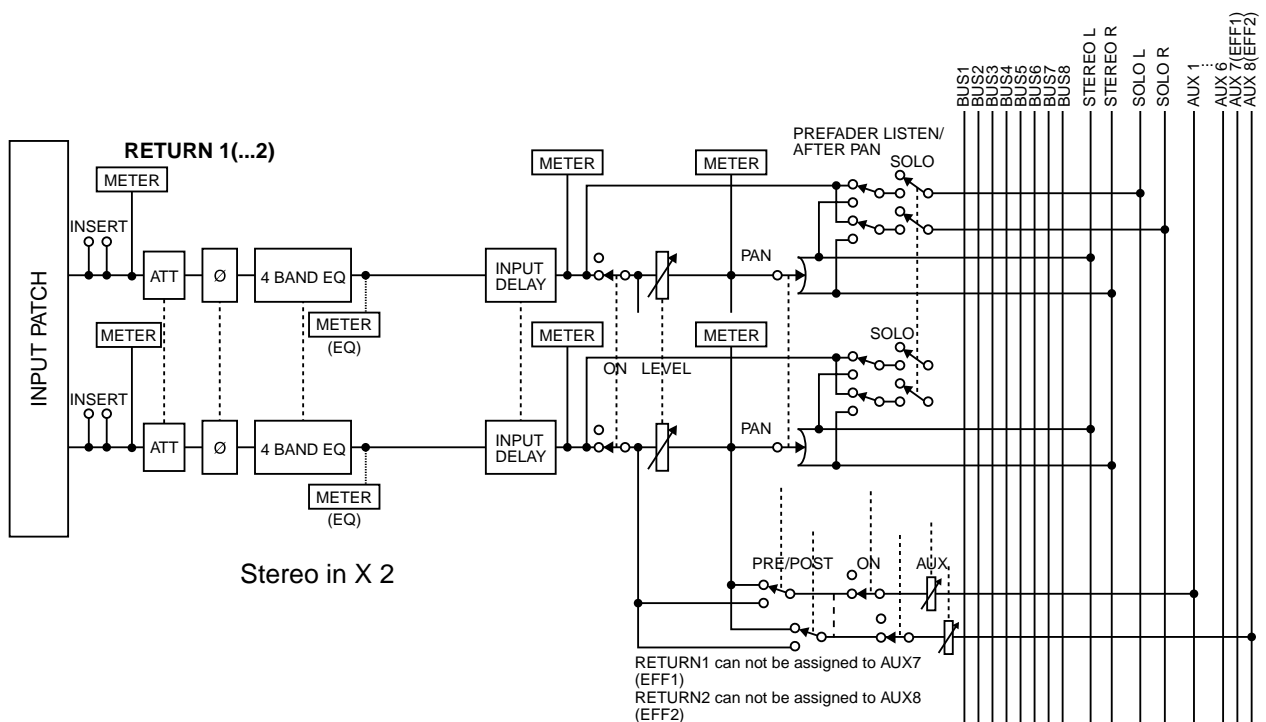

Recorder input patching

This section assigns the signals that are input to tracks 1–16 of the recorder section. The following types of signal can be selected.

○ STEREO

The stereo bus output signal that has passed through the stereo output channel.

○ BUS 1–8

The output signal of buses 1–8.

○ DIRECT OUT 1–16

The direct output signal of input channels 1–16.

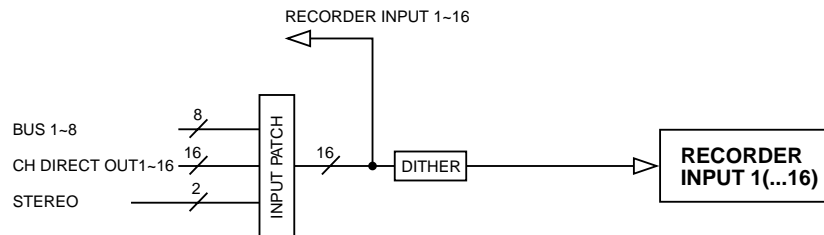

Monitor channels 1–16

These are monaural channels that are assigned to the track 1–16 outputs of the recorder section. According to the input monitor settings or the state of the transport, they will input either the signals being input to tracks 1–16, or the playback signals of tracks 1–16.

As an exception, the stereo track will be patched to monitor channels 1/2 when the stereo track of that song is being played back, and the remainder of the monitor channels 3–16 will be muted.

The structure of these channels is the same as that of the input channels, with the exception that the direct output is fixed at a point immediately before the attenuator.

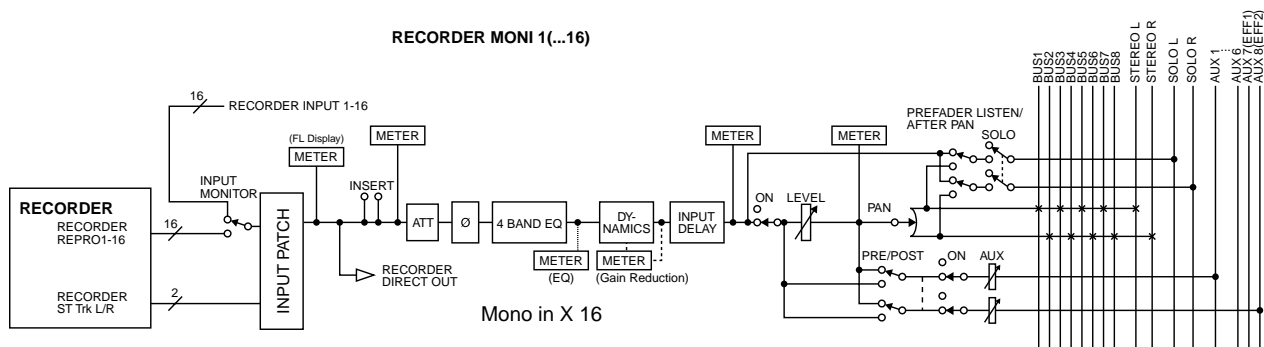

Digital cascade connections

The input signal from the rear panel DIGITAL STEREO IN jack can be cascaded directly into the stereo bus, instead of being sent via the input patch section and patched to a pair of input channels. This is convenient when you wish to use an external digital mixer without linking it to the mixer section of the AW4416. Settings for cascade connection are made in the SET UP screen D.InSetup page.

* For the signal flow diagram, refer to Oscillator, below.

Oscillator

The AW4416 has a built-in oscillator section that allows you to select a sine wave (100 Hz, 1 kHz, 10 kHz) or white noise. The signal of the oscillator can be output from one of the following buses: buses 1–8, AUX buses 1–8, or the stereo bus. Oscillator settings are made in the UTILITY screen Oscillator page.

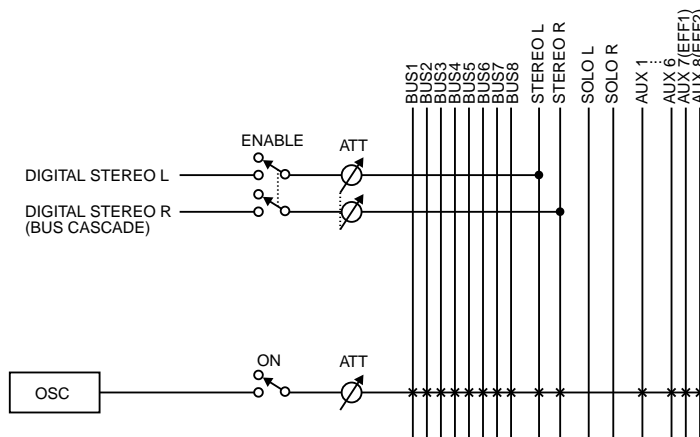

Stereo output channel

This is the stereo output channel that processes the signals sent from each channel to the stereo bus. It provides the same four-band EQ and dynamics processor as do the input channels. The output signal of the stereo output channel is sent via the output patch section to the various output jacks, and is simultaneously output from the MONITOR OUT jacks and the PHONES jack.

When an internal or external CD-RW drive is used to play back an audio CD, the CD audio signal is patched to a point before the fader of the stereo output channel.

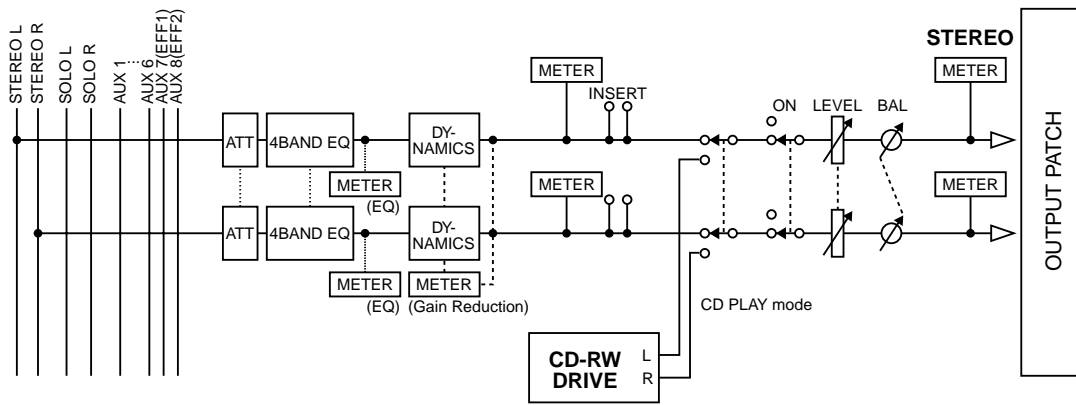

Buses 1–8

The signals sent from each channel to buses 1–8 pass through the master level, and are sent to the output patch section. The master level is adjusted in the HOME screen Bus page ([HOME] key → [F3] key).

* For the signal flow diagram, refer to AUX buses 1–8, below.

AUX buses 1–8

The signals sent to AUX buses 1–8 from each channel pass through the master level, and are sent to the output patch section. The master level is adjusted in the HOME screen Bus page ([HOME] key → [F3] key).



When the AW4416 is in its default state, the output of AUX buses 7/8 is sent to the output patch section, and simultaneously assigned to the inputs of internal effects 1/2 as well.

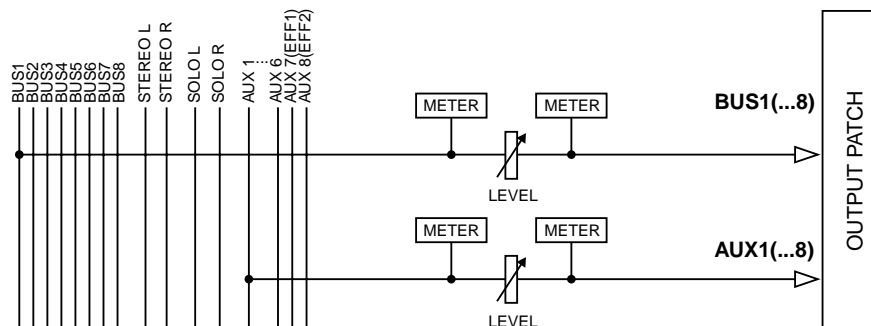

Output patch

This section assigns the output signals to the STEREO OUT jacks, DIGITAL STEREO OUT jack, I/O cards installed in OPTION I/O slots 1/2, and OMNI OUT jacks 1–4. The following types of signals can be selected.

STEREO

The stereo bus output signal that has passed through the stereo output channel.

BUS 1–8

The output signals of buses 1–8.

AUX 1–8

The output signals of buses 1–8.

CH DIRECT OUT 1–16

The direct output of input channels 1–16.

INSERT SEND

An insertion output for inserting an external effect into each channel.

RECORDER DIRECT OUT 1–16

The direct output of tracks 1–16 of the recorder section.

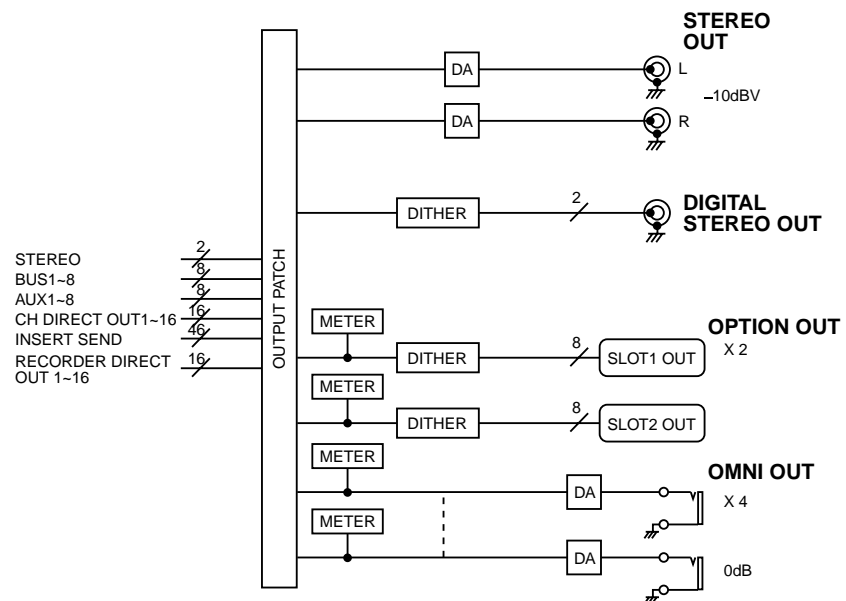

Internal effects 1/2

When the AW4416 is in its default state, the output of AUX bus 7/8 is sent to the output patch section, and simultaneously assigned to the inputs of internal effects 1/2 as well. The outputs of effects 1/2 are respectively assigned to return channels 1/2.

By defeating these assignments, you can insert internal effects 1/2 into any desired channel, or use AUX bus 7/8 or return channels 1/2 for other purposes.

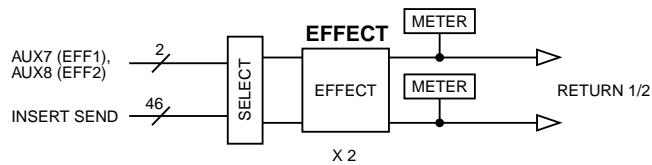

Monitor output/headphone output

As monitoring jacks, the AW4416 provides MONITOR OUT jacks and a PHONES jack. The types of signal that are output from these jacks will change as follows, depending on the state of the AW4416.

① **Initial state**

The signal of the stereo output channel will be output without change from the MONITOR OUT jacks/PHONES jack.

② **When the [SOLO] key is on**

The signal of the channel selected by the [ON] key will be sent to the SOLO bus, and output from the MONITOR OUT jacks/PHONES jack. At this time, all other signals will be muted.

③ **When the TRACK [CUE] key is on**

The direct output signal of the track selected by the [REC TRACK SELECT] key will be output from the MONITOR OUT jacks/PHONES jack.

④ **When the internal metronome function is on**

The metronome signal will be mixed with the output signals of ①–③.



.....

- The same signal is always sent from the MONITOR OUT jacks and the PHONES jack. However, the level adjustment is independent; the output level of the MONITOR OUT jacks is adjusted by the [MONITOR OUT] control, and the output level of the PHONES jack is adjusted by the [PHONES] control.
- Whenever the [SOLO] key and the TRACK [CUE] key are both on, only the TRACK [CUE] key will be valid.

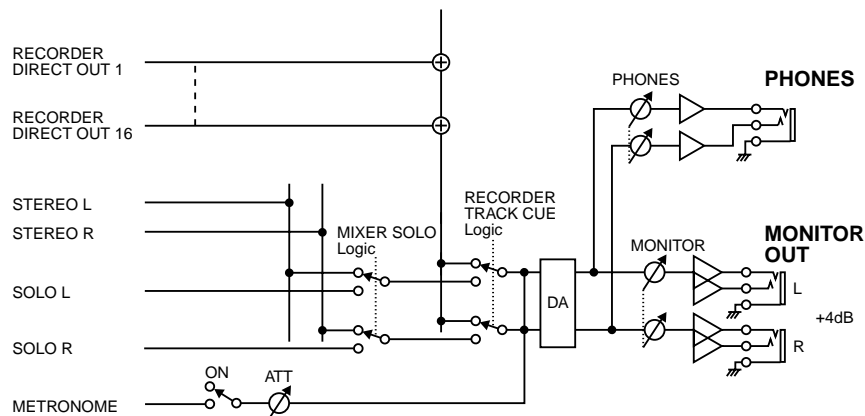

2 Parts and their functions

This chapter explains the names and functions of the various objects on the top panel, rear panel, and front panel.



Names of the controllers on the top panel are enclosed in square brackets [], in order to distinguish them from the “software” knobs or buttons displayed in the display.

Example: [SEL] key, EQ [Q] control

Top panel

Analog input/output section

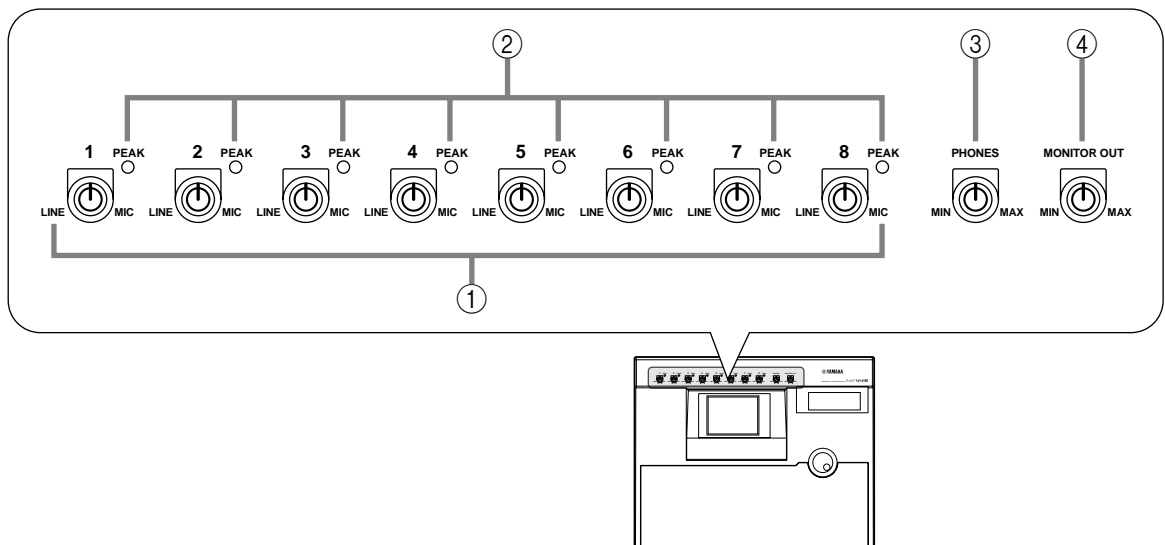

- ① **[GAIN] controls**
These controls adjust the input sensitivity of INPUT jacks 1–8. The supported input level range is -46 dB– $+4$ dB.
- ② **PEAK indicators**
These LEDs will light red when the input signal of INPUT jacks 1–8 reaches a level 3 dB below the clipping point.
- ③ **[PHONES] control**
This control adjusts the output level of the signal that is sent from the rear panel PHONES jack.

④ **[MONITOR OUT] control**

This control adjusts the output level of the signal that is sent from the rear panel MONITOR OUT jacks.

WORK NAVIGATE section

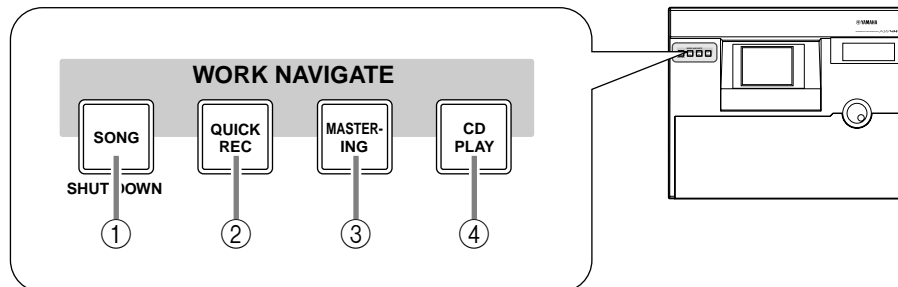
① **[SONG] key**

This key is used for song settings and editing, and to access the SONG screen where you can perform the shut-down operation.

② **[QUICK REC] (quick record) key**

At one touch, this key assigns the physical input jacks to the channels of the mixer section and the tracks of the recorder section, and accesses the QUICK REC screen in which you can record 16 tracks simultaneously.

③ **[MASTERING] key**

This key accesses the MASTERING screen, where the audio data of the stereo tracks can be recorded as CD-DA (CD audio) on a CD-R/RW disc inserted in the CD-R/CD-RW drive (optional).

④ **[CD PLAY] key**

This key accesses the CD PLAY screen, where you can play a music CD or the audio tracks of a CD-ROM/CD-R inserted in the CD-R/CD-RW drive (optional).

UNIT section

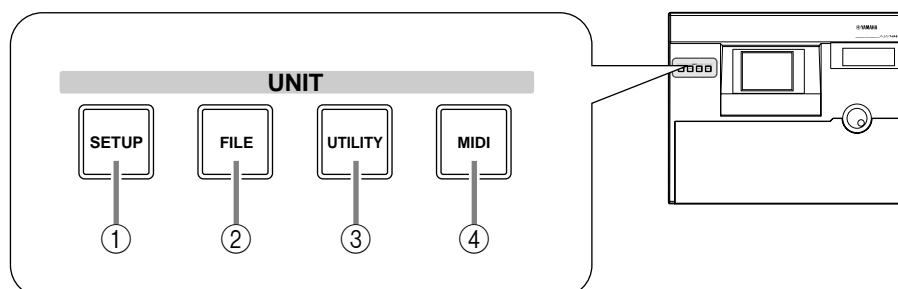
① **[SETUP] key**

This key accesses the SETUP screen, where you can make settings such as external input/output patching, word clock, dither, and the solo function.

② **[FILE] key**

This key accesses the FILE screen, where you can backup/restore songs and format external storage devices connected to the SCSI connector.

③ **[UTILITY] key**

This key accesses the UTILITY screen, where you can operate the built-in oscillator, and make various system settings.

④ **[MIDI] key**

This key accesses the MIDI screen, where you can make MIDI-related settings.

MIXER section

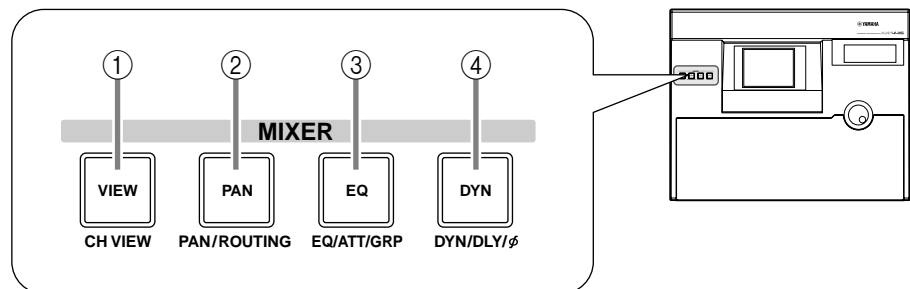
① **[VIEW] key**

This key accesses the VIEW screen, where you can view all the mix parameters of the currently selected channel.

② **[PAN] key**

This key accesses the PAN screen, where you can set the pan and routing of each channel.

③ **[EQ] (equalizer) key**

This key accesses the EQ/ATT/GRP screen, where you can make equalizer/attenuator settings for the currently selected channel, and make fader group and mute group settings.

④ **[DYN] key**

This key accesses the DYN/DLY screen, where you can make dynamics processor and delay settings for the currently selected channel.

FADER MODE section

In this section you can select the items that will be controlled by faders 1–16 of the top panel.

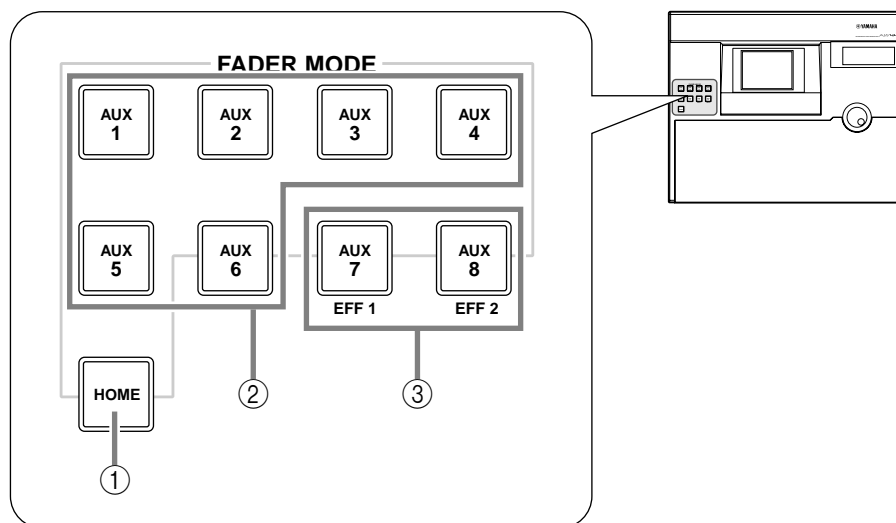

① [HOME] key

When this key is on, faders 1–16 will adjust the input levels of the channels selected in the MIXING LAYER section. The HOME page will appear in the display, showing meters to indicate the input/output levels of each channel.

② [AUX 1]–[AUX 6] keys

When these keys are on, faders 1–16 will adjust the send levels of the signals sent to AUX 1–6 from the channels selected in the MIXING LAYER section. The AUX 1–AUX 6 pages will appear in the display, allowing you to switch the pre or post setting for the signals sent from each channel to AUX 1–6.

③ [AUX 7]/[AUX 8] keys

When these keys are on, faders 1–16 will adjust the send levels of the signals sent to internal effects 1/2 from the channels selected in the MIXING LAYER section. The AUX7/EFF1 screen or AUX8/EFF2 screen will appear in the display, allowing you to switch the pre or post setting for the signals sent from each channel to internal effects 1 and 2, and to set the effect parameters.

MIXING LAYER section

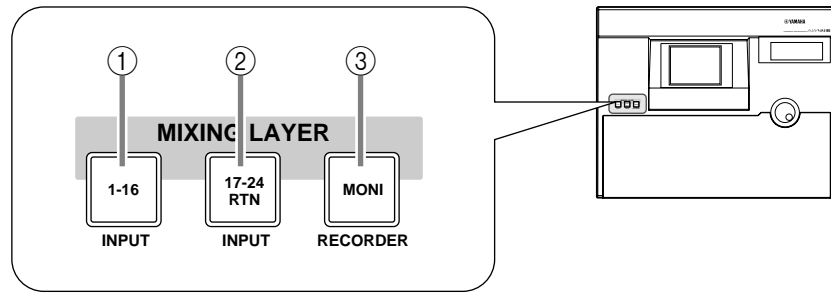

- ① [1-16] key
- ② [17-24] key
- ③ [MONI] key

In this section you can select the mixing layer that will be controlled by the top panel [SEL] keys 1–16, [ON] keys 1–16 and faders 1–16.

These keys correspond to mixing layers as follows.

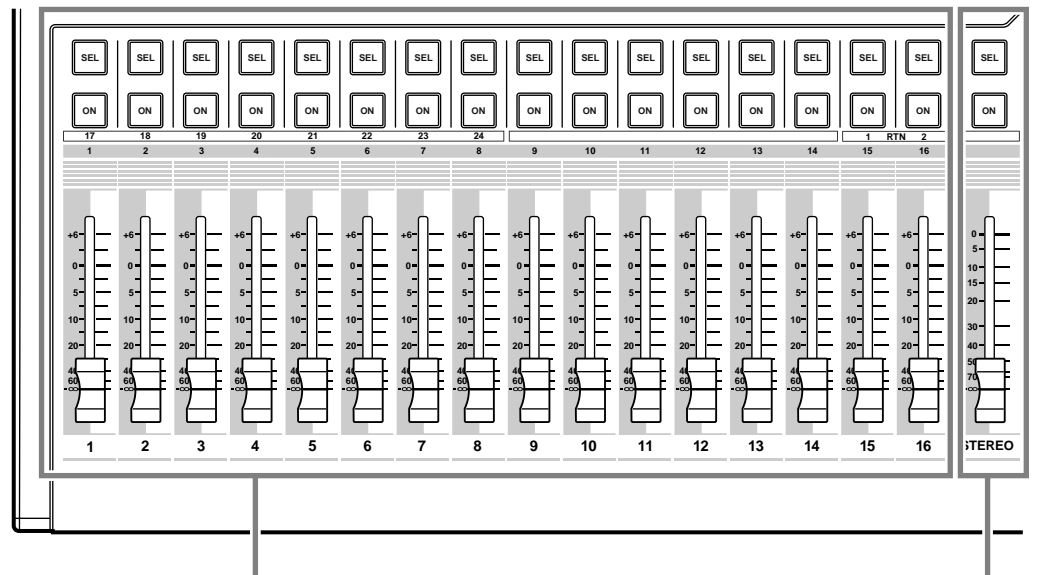
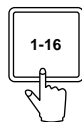

Input channels 1–16

Stereo output channel

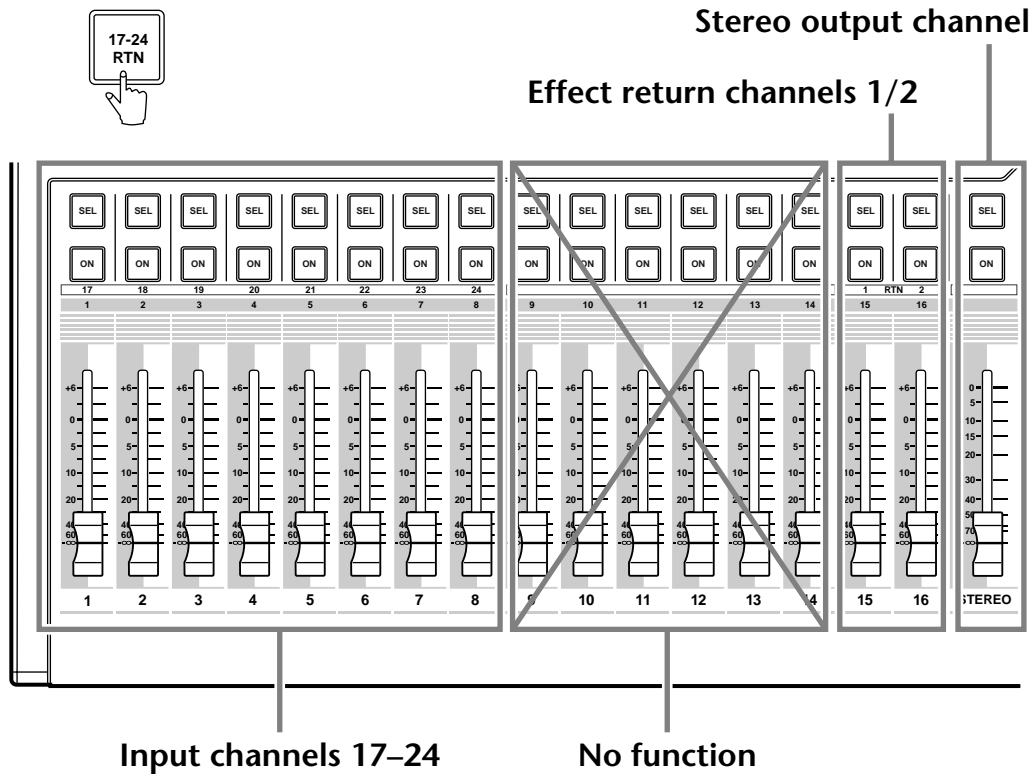

The faders will not be operable. Attempting to move them by force will cause malfunctions.

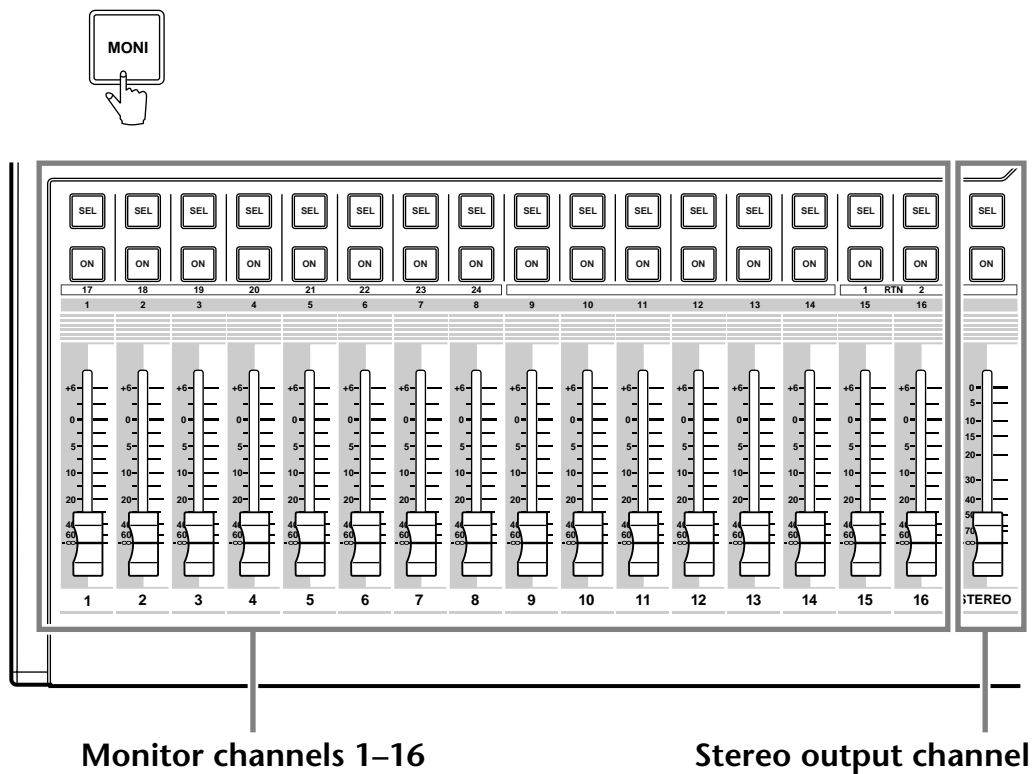

The parameters controlled by faders 1-16 will also change depending on the settings of the FADER MODE section.

[SEL] keys, [ON] keys, faders

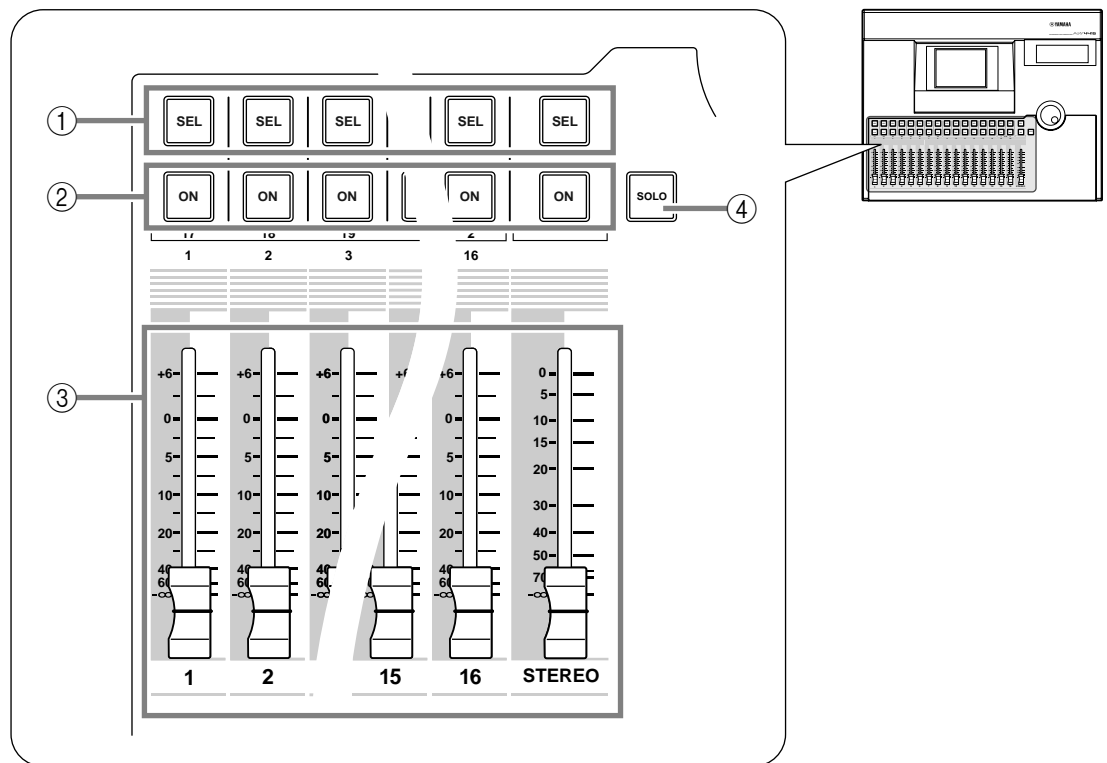

① [SEL] (select) keys

These keys select the channel to be operated. The [SEL] key of the currently selected channel will light. When using automix, the [SEL] keys are used to select the channels that will be recorded.

② [ON] key

These keys turn each channel on/off. The [ON] key will be lit for channels that are currently on; the [ON] key will be dark for channels that are off (muted). When the solo function is on, the [ON] keys will function as solo keys.

③ Faders

Depending on the settings of the FADER mode section, these moving faders adjust the input level or send levels to AUX 1–8 for each channel.



- The channels that correspond to the [SEL] keys 1–16, [ON] keys 1–16, and faders 1–16 will change depending on the setting of the MIXING LAYER section.
- The STEREO [SEL] key, STEREO [ON] key, and STEREO fader always control the stereo output channel. They are not affected by the MIXING LAYER section.

④ [SOLO] key

This key turns the Solo function on/off.

Display section

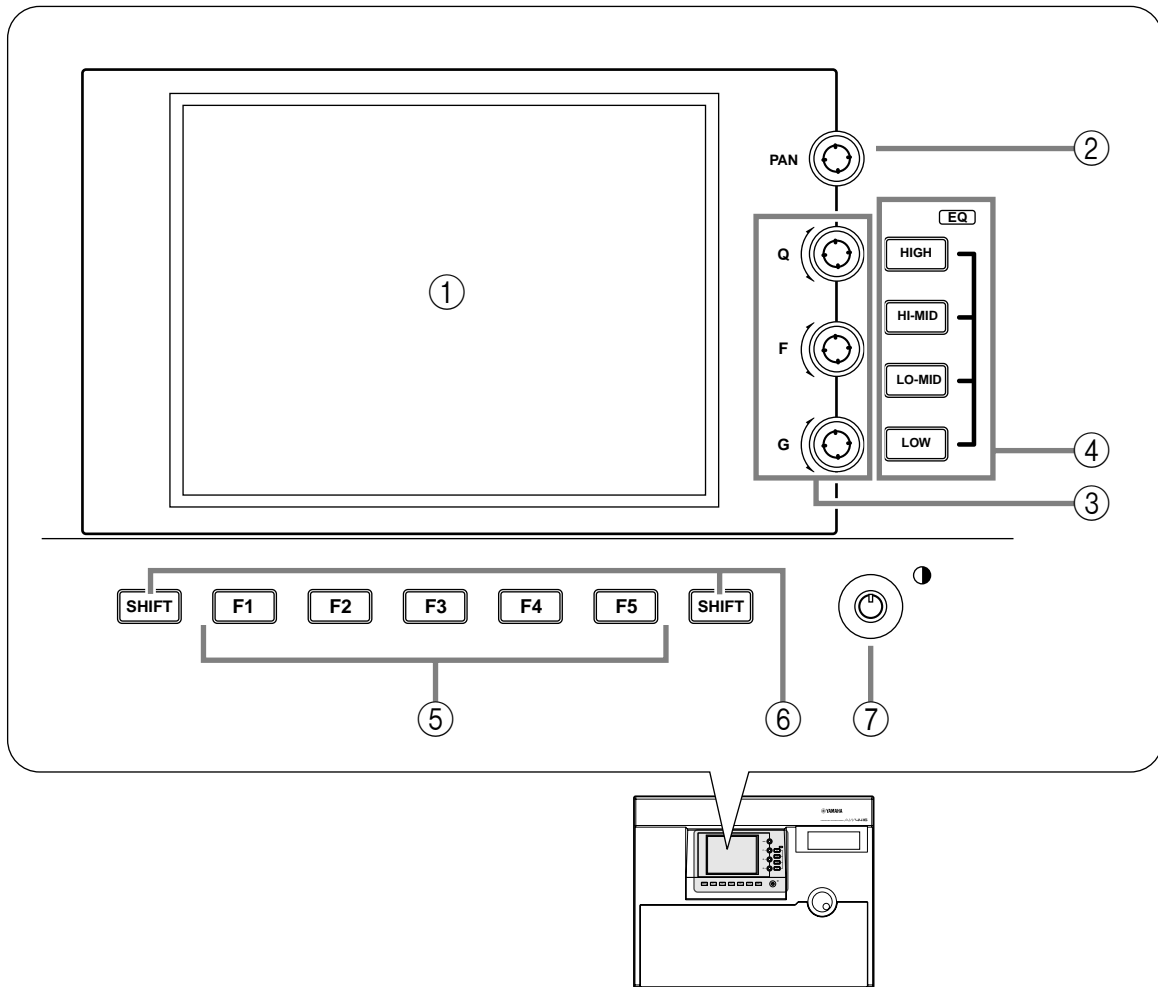

① Display

This is a 320×240 pixel liquid crystal display with backlight, that displays the values of the mix parameters and the current operating status.

② [PAN] control

This controls the pan of the channel currently selected by the [SEL] key. If the stereo output channel is selected, this controls the L/R channel balance.

③ EQ [Q]/EQ [F] (EQ frequency)/EQ [G] (EG gain) controls

These are controls for manually operating the EQ of the channel currently selected by the [SEL] key. From above, they adjust the Q (steepness), F (center frequency), and G (gain) parameters. Use the ④ EQ [HIGH]–EQ [LOW] keys to select the band that will be controlled.

④ EQ [HIGH]/EQ [HI-MID]/EQ [LO-MID]/EQ [LOW] keys

These keys select the band that will be controlled by the ③ controls.

⑤ [F1]–[F5] (function 1–5) keys

These keys are used to access pages or to execute specific functions, according to the tabs or buttons shown at the bottom of the display.

⑥ **[SHIFT] key**

This key is used to switch the tabs or buttons shown at the bottom of the display. You can use a variety of additional functions by holding down the [SHIFT] key and pressing the [F1]–[F5] keys.



symbol is displayed in the lower left of the screen to indicate a page that supports the [SHIFT] key.

⑦ **Contrast**

This adjusts the contrast of the display.

Level meter/counter section

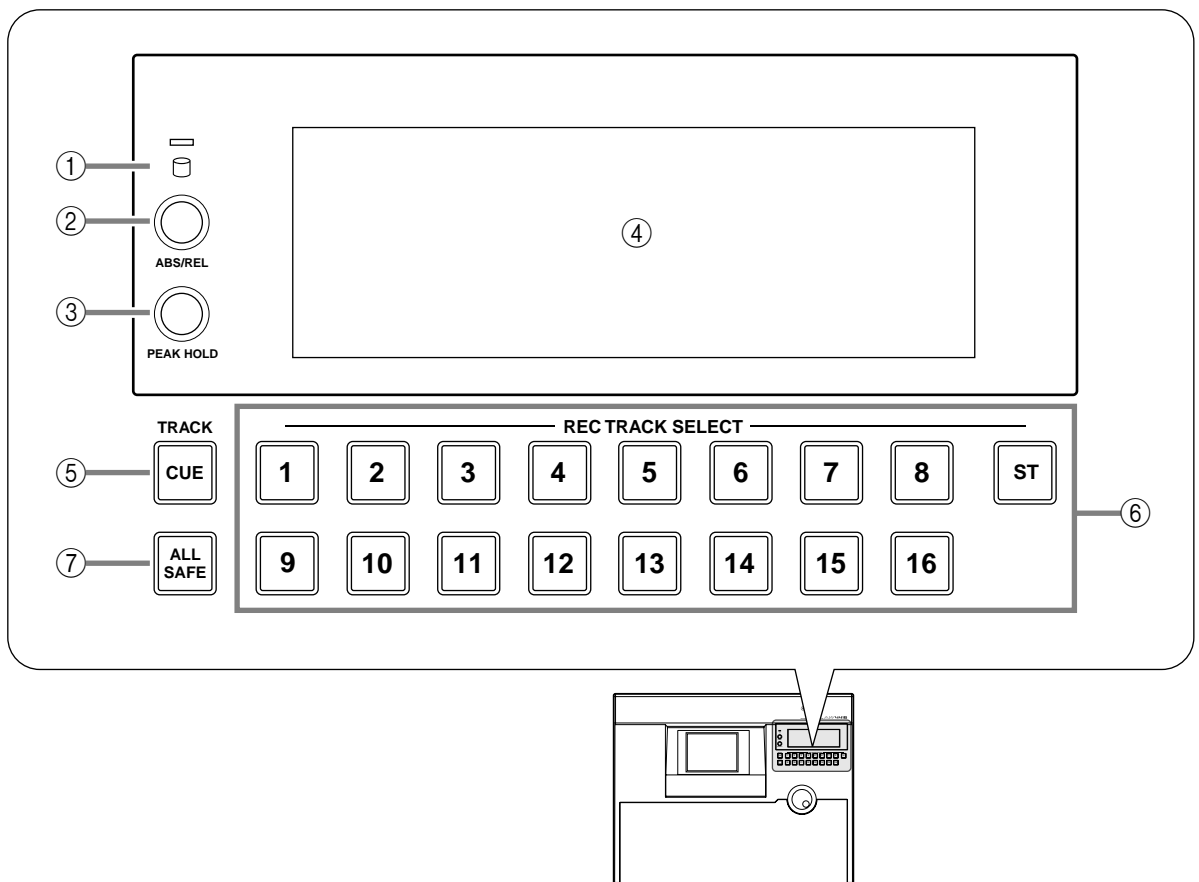
① **Access indicator**

This indicator shows that the internal hard disk is being accessed. This indicator will light red while the hard disk is being read or written.



Turning off the power while the access indicator is lit may not only result in loss of the data on disk, but may also destroy the disk itself. You must perform the shut-down process (→ P.17) before turning the power off.

② **[ABS/REL] switch**

This switches the counter display between absolute time (ABS) or relative time (REL).

- ③ **[PEAK HOLD] switch**
This switch sets/defeats the peak hold function of the level meters.
- ④ **Level meters/counter**
This area displays various information necessary when operating the recorder section of the AW4416, such as level meters for each track of the recorder section, a time counter, and the number of the currently selected scene memory.
- ⑤ **TRACK [CUE] key**
This key is used to output the signal of the desired track directly to the MONITOR OUT jacks for monitoring. Use the [REC TRACK SELECT] keys to select the track.
- ⑥ **[REC TRACK SELECT] keys**
Use these keys to select the track(s) to be recorded. When the TRACK [CUE] key is on, these keys select the track to be monitored.
- ⑦ **[ALL SAFE] key**
This key cancels all record-ready settings of the [REC TRACK SELECT] keys.

RECORDER section

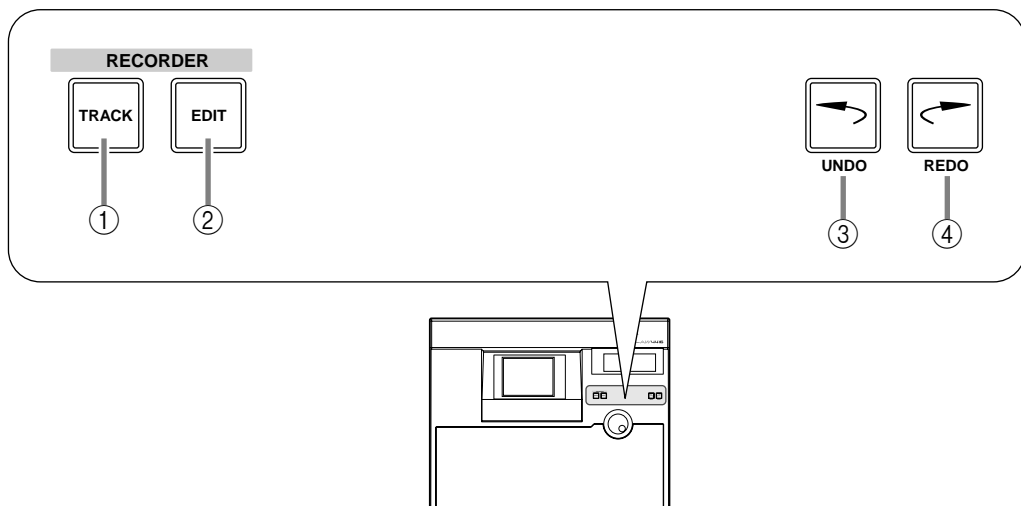

- ① **[TRACK] key**
This key accesses the TRACK screen, where you can view the recorded status of each track and make virtual track assignments.
- ② **[EDIT] key**
This key accesses the EDIT page, where you can edit tracks and virtual tracks.
- ③ **[UNDO] key**
This key cancels the recording or editing operation that was last executed in the recorder section, restoring the data to its previous state. By repeatedly pressing the [UNDO] key, you can return through as many as sixteen previous operations.
- ④ **[REDO] key**
This key re-executes the recording or editing operation that was cancelled by the [UNDO] key.

AUTOMATION section

The keys of this section access screen pages where you can operate the automix and scene memory functions.

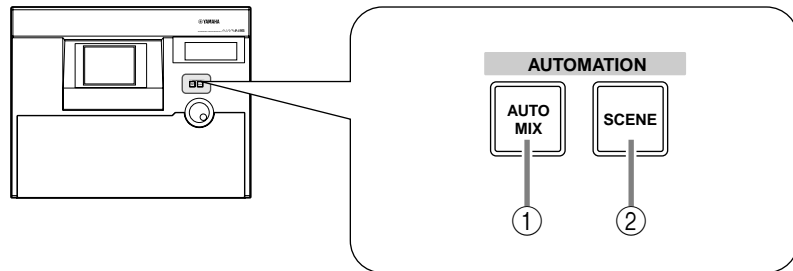

The following screens correspond to these keys.

- ① **[AUTOMIX] key**
This key accesses the AUTOMIX screen, where you can operate and edit automix.
- ② **[SCENE] key**
This key accesses the SCENE screen, where you can perform scene memory operations.

SCENE MEMORY section

In this section you can directly store or recall scene memories.

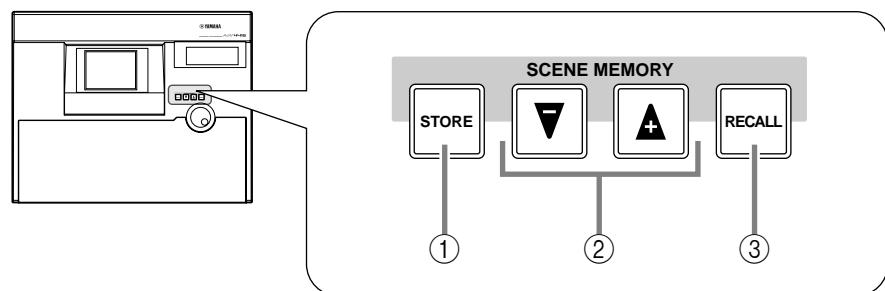

- ① **[STORE] key**
This key stores the state of the mixer section and input/output patching into the scene number shown in the display or the level meter/counter.
- ② **[▼]/[▲] keys**
These keys select the scene number for storing or recalling.
- ③ **[RECALL] key**
This key recalls the scene whose number is shown in the display or in the level meter/counter.

CURSOR/JOG & SHUTTLE section

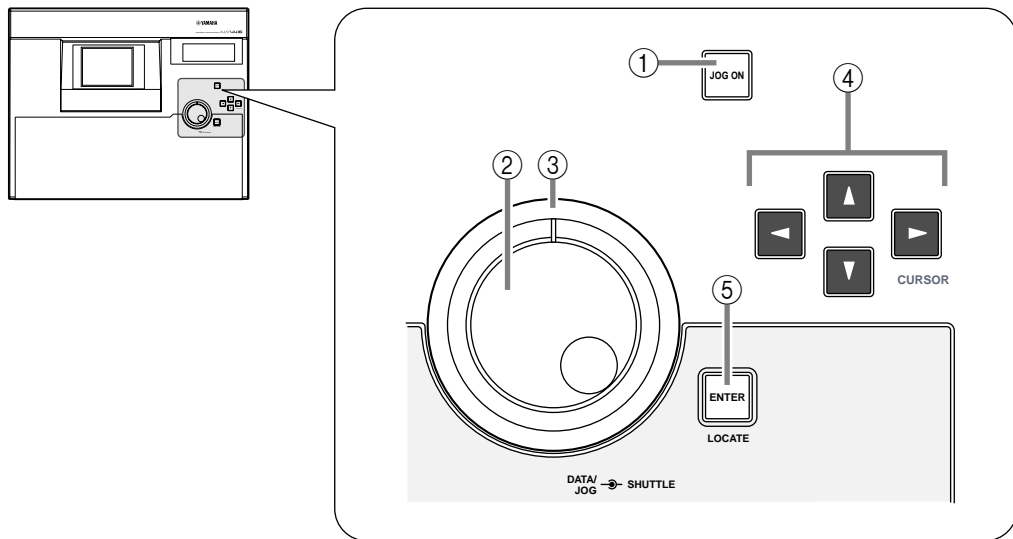

① [JOG ON] key

This key turns the “nudge” function on/off for the [DATA/JOG] dial and [SHUTTLE] dial. (“Nudge” is a function that repeatedly plays back a fixed region starting at the current location, either forward or backward.) When this is turned on, the key will light.

② [DATA/JOG] dial

The function of this dial will depend on the on/off status of the [JOG ON] key, and on the on/off status of the [NUM LOCATE] key in the locate section.

○ When the [JOG ON] key is off

The dial will adjust the value of the parameter currently selected in the display, or select an item from a list.

○ When the [JOG ON] key is on

Depending on the direction in which you turn the dial, playback of a fixed region will occur repeatedly in the forward or reverse direction, allowing you to search for a desired location.

○ When the [NUM LOCATE] key is on

The dial will advance the time counter in the display.

③ [SHUTTLE] dial

The function of this dial will depend on the on/off status of the [JOG ON] key.

○ When the [JOG ON] key is on

The current nudge playback region will be moved either forward or backward, depending on the direction in which you turn the dial.

○ When the [JOG ON] key is off

Depending on the direction and angle to which you turn the dial, reverse (review) or fast-forward (cue) playback will occur at a variety of speeds.

④ CURSOR [◀]/[▶]/[▲]/[▼] keys

These keys move the cursor (the blinking box) in the display.

⑤ **[ENTER] key**

This key is used to finalize a value, execute a function, or move to the specified locate point.

Locate section

In this section you can perform locate operations for the recorder.

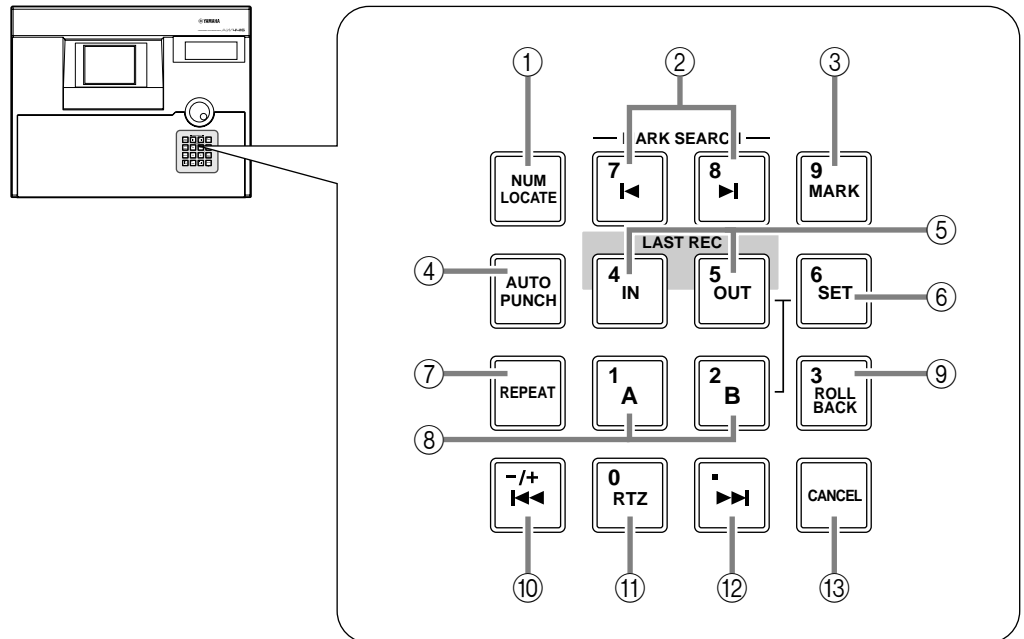
① **[NUM LOCATE] (number locate) key**

This key is used to specify a locate point as a numerical value. When this key is lit, you can use the numeric keys or the [DATA/JOG] dial to input a locate position, and press the [ENTER] key to execute the Locate operation.

② **MARK SEARCH [◀]/[▶] keys**

These keys are used to move to the nearest pre-specified mark point.

③ **[MARK] key**

When you press this key, the current location will be memorized as a mark point.

④ **[AUTO PUNCH] key**

This key turns the auto punch-in/out function on/off.

⑤ **LAST REC[IN]/[OUT] (last record in/out) keys**

These keys move to the point at which recording was last begun (the IN point) or ended (the OUT point).

⑥ **[SET] key**

This key is used in conjunction with the LAST REC[IN]/[OUT] keys and the [A]/[B] keys to set the last record in/out points or the A/B points. It is also used in conjunction with the [RTZ] key to set the zero point of relative time (REL).

- ⑦ **[REPEAT] key**
When this key is on, the area from the A point → B point will be played repeatedly. To cancel repeat playback, press the [REPEAT] key once again, or press the [STOP] key in the transport section.
- ⑧ **[A]/[B] keys**
These keys move to the pre-specified A or B points.
- ⑨ **[ROLL BACK] key**
When this key is pressed, you will move backward from the current location by the length of time specified in the UTILITY screen → Prefer.2 page.
- ⑩ **[⏮] key**
Pressing this key will move to the start point of the song.
- ⑪ **[RTZ] (return to zero) key**
Pressing this key will move to the zero location of absolute time (if the counter indicates ABS) or the zero location of relative time (if the counter indicates REL).
- ⑫ **[⏭] key**
Pressing this key will move to the end point of the song.
- ⑬ **[CANCEL] key**
This key is used to discard a numerical value that you input, or to cancel operation of a function.

Transport section

In this section you can operate the transport of the recorder.

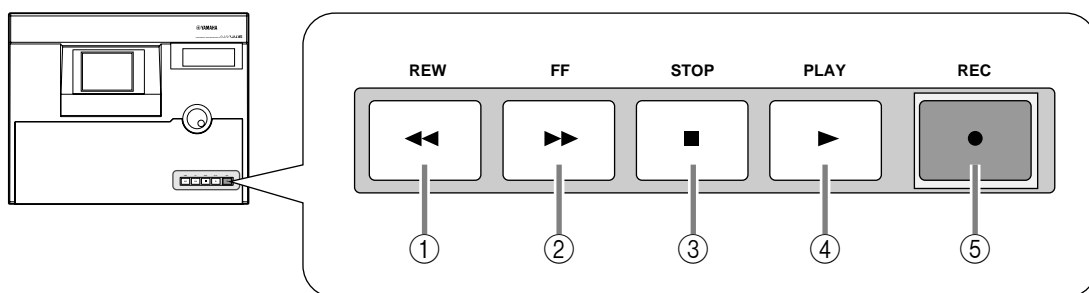

- ① **[REW] (rewind) key**
This key rewinds the current location. By repeatedly pressing this key, you can switch between 8x and 16x speeds. To stop rewind, press the [STOP] key or the [PLAY] key.
- ② **[FF] (fast-forward) key**
This key fast-forwards the current location. By repeatedly pressing this key, you can switch between 8x and 16x speeds. To stop fast-forward, press the [STOP] key or the [PLAY] key.

③ **[STOP] key**

This key interrupts playback, recording, rewind, or fast-forward, and stops the recorder.

④ **[PLAY] key**

If the recorder is stopped, pressing this key will begin playback (if the key is pressed by itself) or record (if the key is pressed while holding down the [REC] key). If this key is pressed during rewind or fast-forward, the respective operation will be interrupted, and normal-speed playback will begin. If this key is pressed during recording, recording will be interrupted and playback will continue (punch-out).

⑤ **[REC] key**

If the recorder is stopped, pressing this key holding down the [PLAY] key will begin recording. Pressing this key holding down the [PLAY] key during playback will begin recording from that point (punch-in).

SAMPLING PAD section

In this section you can operate the built-in sampler.

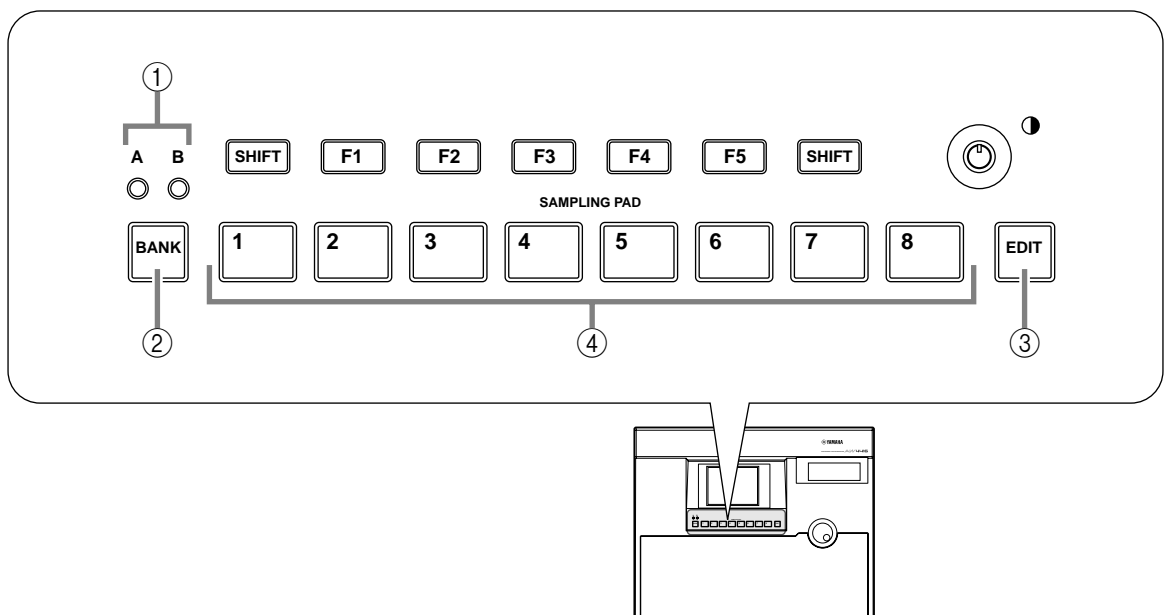
① **A/B bank indicators**

These will light to indicate the currently selected bank (A or B) of sampling pads.

② **[BANK] pad**

This pad selects the pad bank (A or B).

③ **[EDIT] pad**

This pad accesses the SAMP.PAD screen, where you can assign sampled sounds or tracks to each pad.

④ **Pads 1–8**

These pads play back the sampled sounds that have been assigned to each pad.

Rear panel

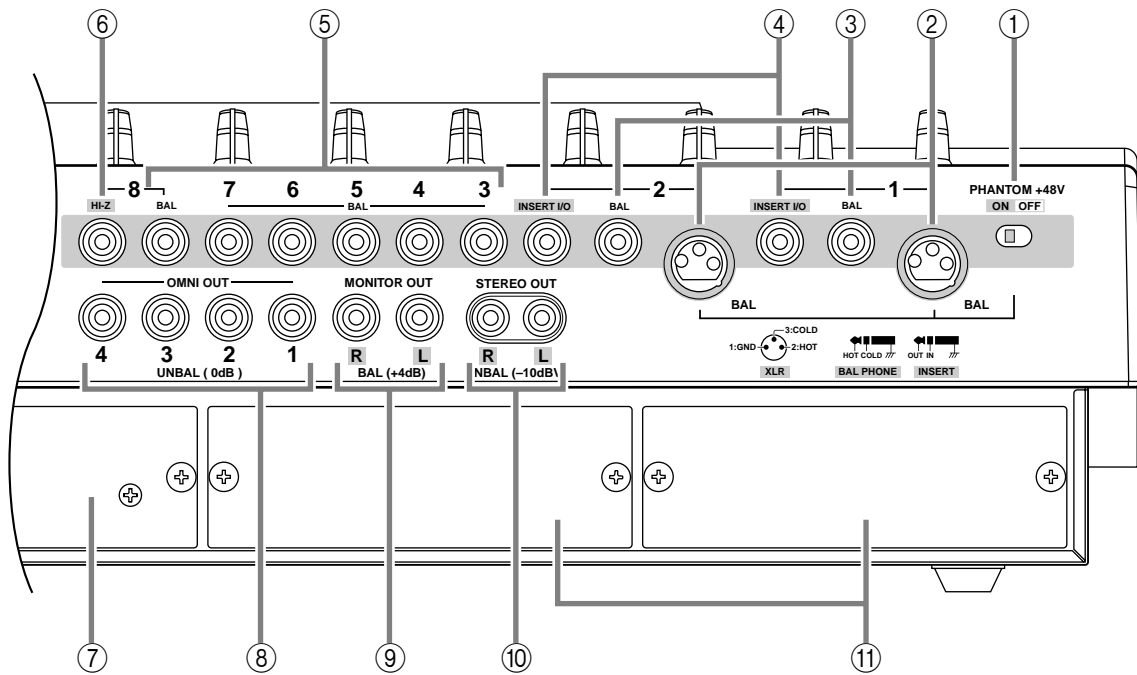

① [PHANTOM +48V ON/OFF] switch

This switch supplies +48 V phantom power to the INPUT (XLR) 1/2 jacks.

② INPUT 1/2 (XLR) jacks

These are balanced XLR-3-31 type input jacks. Nominal input level is $-46\text{ dB} +4\text{ dB}$. Pin connections are as follows.

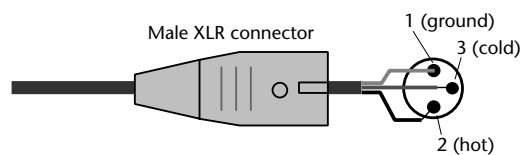

③ INPUT 1/2 (phone) jacks

These are balanced TRS phone type input jacks. Nominal input level is $-46\text{ dB} +4\text{ dB}$. Pin connections are as follows.

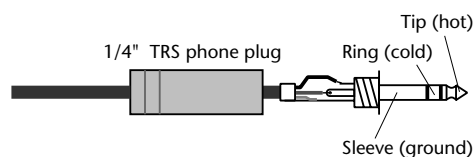

If plugs are inserted into both the XLR jack for INPUT 1/2 and the phone jack, the phone jack will take priority.

④ INSERT I/O 1/2 jacks

These are TRS phone jacks that allow an external effect etc. to be inserted into the input signal of INPUT jacks 1/2. Nominal input level is 0 dB. Pin connections are as follows.

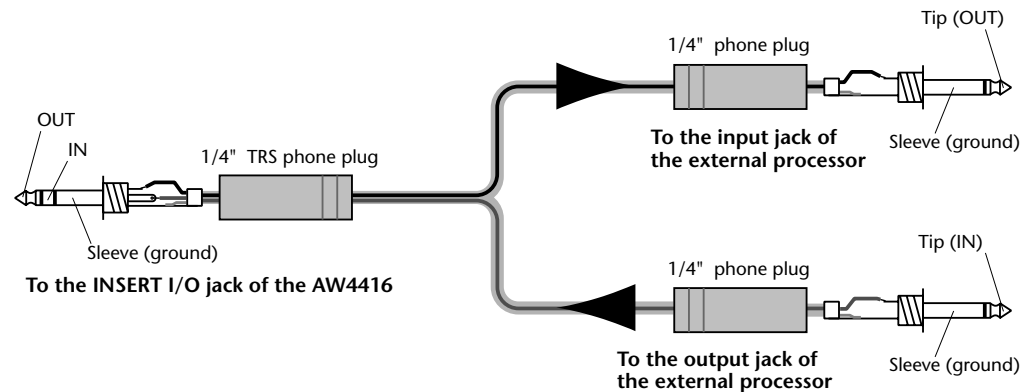

⑤ INPUT 3–8 (phone) jacks

These are balanced TRS phone type input jacks. The specifications are the same as for ③ INPUT 1/2 (phone) jacks.

⑥ INPUT 8 (HI-Z) jack

This is a high impedance unbalanced phone type input jack. Instruments with a high output impedance such as passive type electric guitars can be directly connected here. Nominal input level is $-46\text{ dB} - +4\text{ dB}$.



.....
If plugs are inserted into both the normal INPUT 8 (BAL) jack and the INPUT 8 (HI-Z) jack, the INPUT 8 (HI-Z) jack will take priority.

⑦ 2.5" HARD DISK DRIVE slot

This slot allows an IDE 2.5 inch hard disk to be installed.



-
- For the procedure of installing the hard disk, refer to page 2.
 - For a list of manufacturers and models of hard disk that are known to work when installed in the AW4416, please refer to the website <<http://www.aw4416.com>>

⑧ OMNI OUT 1–4 jacks

These are unbalanced phone jacks that output the analog signal assigned to OMNI OUT 1–4 in the SETUP screen → Patch OUT page (→ P.136). Nominal output level is 0 dB.

⑨ MONITOR OUT jacks

These are balanced TRS phone jacks that output analog monitor signals such as the stereo bus, internal metronome, solo signal, or direct output from recorder tracks 1–16. Nominal output level is $+4\text{ dB}$.

⑩ STEREO OUT jacks

These are unbalanced RCA phono jacks that output the analog signal assigned to ST OUT in the SETUP screen → Patch OUT page (→ P.136). Nominal output level is -10 dBV .

⑪ OPTION I/O slots 1/2

These slots allow optional I/O cards to be installed. Assignments for the signals input or output via the I/O cards are made in the SETUP screen → Patch IN page (→ P.133), and in the SETUP screen → Patch OUT page (→ P.136).



Note

For details on installing an I/O card, refer to page 14.

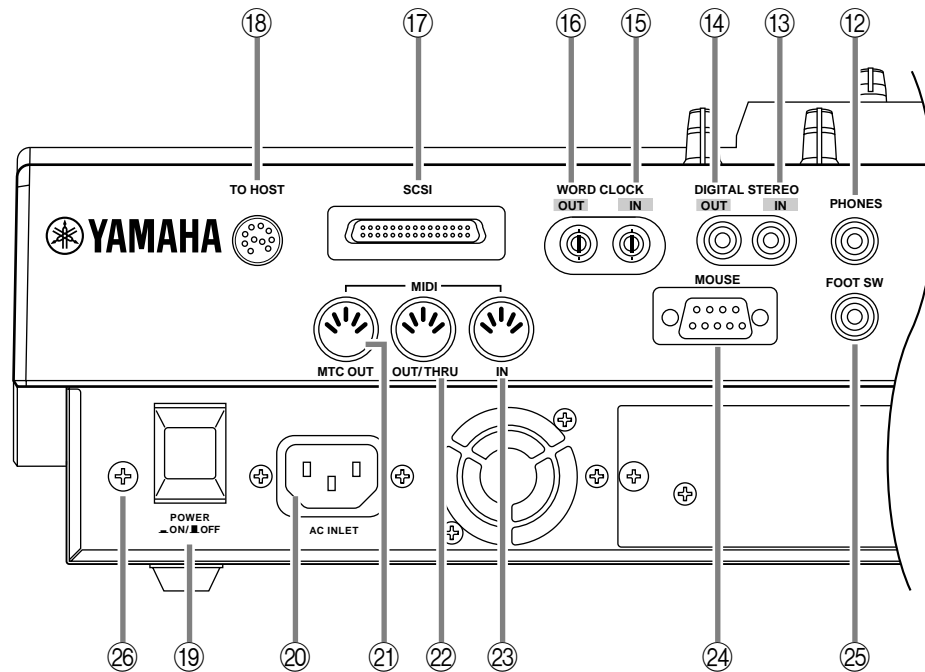

⑫ PHONES jack

This is a stereo headphone jack that allows a set of stereo headphones to be connected. This jack will always output the same signal as the MONITOR OUT jacks.

⑬ DIGITAL STEREO IN jack

This is a coaxial jack that digitally inputs a stereo signal. It is compatible with the IEC958 consumer format. The channel to which this signal will be input is assigned in the SETUP screen → Patch IN page (→ P.133).

⑭ DIGITAL STEREO OUT jack

This is a coaxial jack that digitally outputs the stereo signal assigned to D.ST OUT in the SETUP screen → Patch OUT page (→ P.136). It is compatible with the IEC958 consumer format.

⑮ WORD CLOCK IN jack

⑯ WORD CLOCK OUT jack

These are BNC type jacks for input/output of a word clock signal. They are used to synchronize the digital audio signal processing with an external device.

⑰ SCSI connector

This is a D-sub half-pitch 50 pin SCSI connector that is compatible with the SCSI-2 standard. SCSI-2 compatible storage devices can be connected for data backup.



- To connect the AW4416 to an external device, use only high-impedance SCSI cables shorter than 1 meter and with an impedance of 100 ohms (± 10 ohms).
- Storage devices connected to the SCSI connector are used for data backup. They cannot be used directly for recording or playback.
- The only types of SCSI-2 storage devices that can be connected are MO, HD, and CD-R/W drives. For a list of manufacturers and models of storage device that are known to work with the AW4416, please refer to the website <<http://www.aw4416.com>>

⑱ TO HOST connector

This is an 8-pin mini-DIN connector that can be connected directly to the serial port of a PC or Macintosh, allowing MIDI applications programs to be used.

⑲ POWER switch

This switch turns the power on/off.

⑳ AC INLET connector

Connect the included power supply cable here to supply power to the unit.



Use only the included power supply cable.

㉑ MTC OUT connector

These connectors are used to send and receive MIDI messages to and from external MIDI devices. The MIDI IN connector receives messages. The MIDI OUT/THRU jack can function either as a MIDI OUT or MIDI THRU connector, depending on the setting of the MIDI screen → MIDI Setup page MIDI OUT SELECT. parameter. The MTC OUT connector is an output connector dedicated to MTC (MIDI Time Code) messages.

㉒ MIDI OUT/THRU connector

㉓ MIDI IN connector

㉔ MOUSE connector

This is a D-sub 9-pin (male) connector for connecting a serial mouse. By using this connector, you can use a mouse to select parameters within the display or to change pages.

㉕ FOOT SW jack

An optional foot switch (Yamaha FC5) can be connected to this jack, and used to play/stop the transport, or to manually punch-in/out.



If a foot switch of the wrong format is connected, the unit may not operate correctly.

㉖ Grounding connector

To reduce the risk of electrical shock, connect this to a grounding connection (earth) before you connect the power cable. This unit comes with a three-conductor power cable. In this case, the same result will be obtained if the ground pin of the electrical outlet is connected to ground. This will also reduce hum and noise.

Front panel

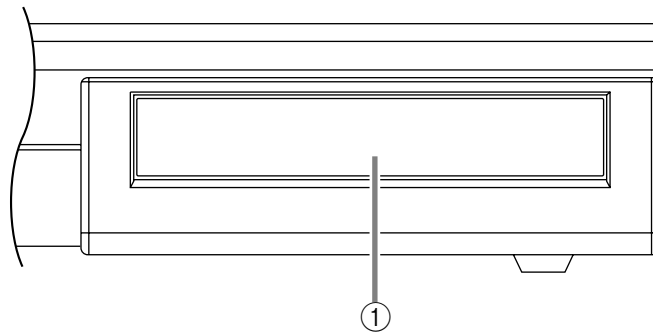

① **CD-RW drive cover**

This covers the CD-RW drive (option) installation bay.



Note

.....
For details on installing a CD-RW drive, refer to page 5.

3

The user interface of the AW4416

This chapter explains the various parts of the AW4416's user interface, and basic operation of the AW4416.

Display

The display in the top panel shows the following information.

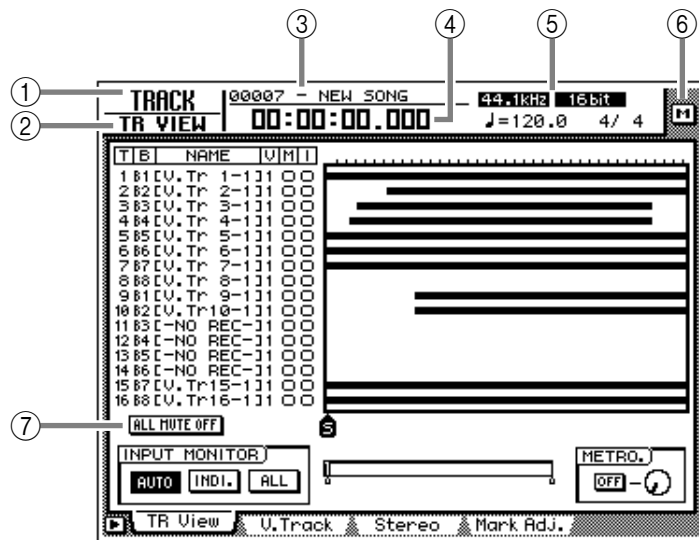

- ① **Screen name**
This is the name of the currently selected screen.
- ② **Page name/channel**
The information shown here will depend on the screen. It will show either the name of the page selected within the screen, or the channel that is selected for operation.
- ③ **Song name**
This is the name of the currently selected song.
- ④ **Current location**
This shows the current time location of the song, and the remaining available recording time. The units of the current location can be selected from the following. (Refer to Reference Guide “SONG screen/Setting page.”)
 - **Time display** (SECOND) Hours:minutes:seconds:milliseconds
 - **Time code display** (TIME CODE) .. Hours:minutes:seconds:frames:sub-frames
 - **Measure display** (MEASURE) Measures/beats/ticks (1/960th of a quarter note)

The remaining recording time will be displayed in the TRACK screen TR View page when you press the [SHIFT] + [F1] key.

⑤ Song/scene information

The information shown in this location will depend on the screen: the sampling frequency, quantization, and tempo/meter of the currently selected song, or the number and name of the currently selected scene.

⑥ M (menu) button

This button selects the display access menu. The display access menu lets you switch screens using the mouse instead of the keys of the top panel (→ P.56).

⑦ Main screen

The information shown here will depend on the key that was pressed last. The following user interface components are used in the main screen.

○ Cursor

The blinking rectangular frame in the display is called the “cursor.” When the cursor surrounds an on-screen item, that item is selected for operation.

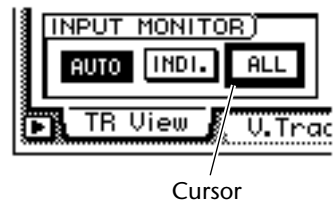

Cursor

○ Pointer

If a serial mouse is connected to the MOUSE connector on the rear panel, a black arrow will appear in the display. This arrow is called the “pointer.” The pointer is used to select the item that will be manipulated by the mouse.

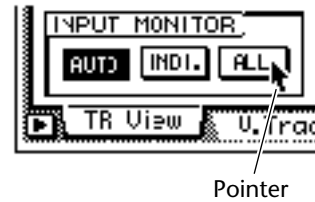

Pointer

The action of moving the pointer to the desired item pressing the left button or right button of the mouse is called “clicking.”

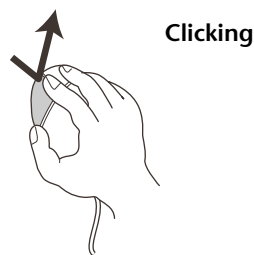

Tip!

When clicking the mouse to adjust a parameter value, the value will increase by one each time you click the right button, and decrease by one each time you click the left button.

The action of moving the pointer to the desired item, then pressing and holding the left button or right button of the mouse and moving the mouse is called “dragging.”

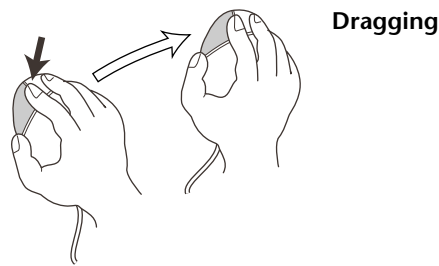

Tip!

When dragging the mouse to continuously adjust a parameter value, the value will change more rapidly if you hold down the right button while dragging. The value will change at the usual rate if you hold down the left button while dragging.

○ Buttons

Buttons in the display are used to turn parameters on/off, or to select one of multiple possibilities. Buttons that are currently on are displayed as white text on a black background, and buttons that are currently off are displayed as black text on a white background.



○ Knobs/faders/numerical boxes

Knobs/faders/numerical boxes in the display are used to modify the value of the corresponding parameter. The value of a knob or fader is displayed below or at the right.

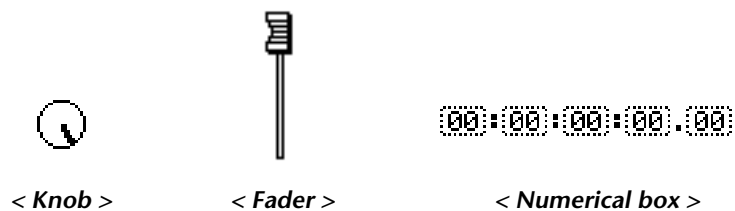

○ Tab

If a screen includes multiple pages, the name of each page will be shown at the bottom of the display. The areas where these names appear are called “tabs.” Tabs are used to switch pages within a screen.

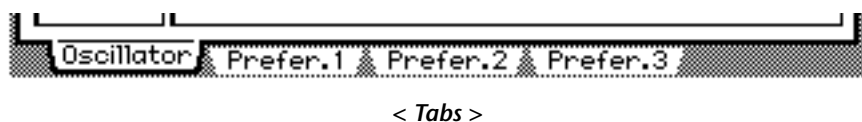

In some screens, you can access additional items or buttons in this area. Such screens are indicated by a  symbol in the lower left of the display.



<  symbol indicating that there are additional tabs or buttons >

Level meters/counter

The level meters/counter in the upper right of the top panel show the following information.

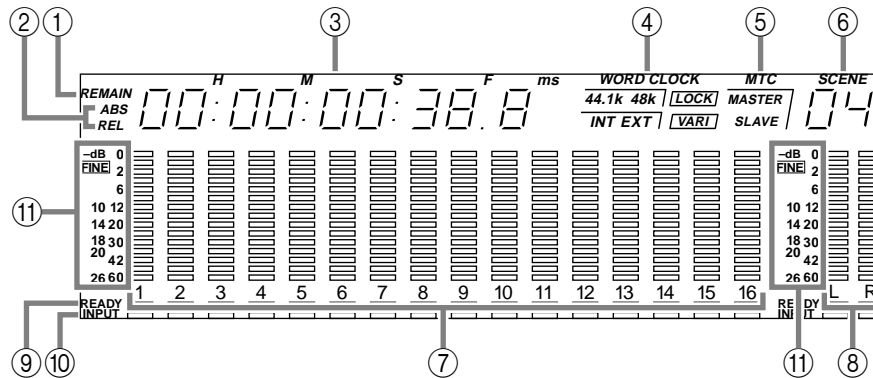

① REMAIN indicator

This will light when the counter ③ shows the remaining recording time. In the TRACK screen TR View page, this will appear when you press [SHIFT] + [F1].

② ABS/REL indicator

One of these indicators will light when the time/timecode shown in the counter ③ is either absolute time (ABS) or relative time (REL). To switch between absolute time and relative time, use the ABS/REL switch located at the right of the level meter/counter.

③ Counter

This is the current time in the song. You can select from the following units for display (Refer to Reference Guide “SONG screen/Setting page”).

- **Time display** (SECOND) Hours:minutes:seconds:milliseconds
- **Time code display** (TIME CODE) .. Hours:minutes:seconds:frames:sub-frames
- **Measure display** (MEASURE) Measures/beats/ticks (1/960th of a quarter note)

④ Word clock

This shows the source (INT=internal clock or EXT=external clock) of the clock according to which the AW4416 is operating, and the frequency (44.1 k or 48 k). This will indicate “LOCK” if the AW4416 is locked to the clock source, and “VARI” if the vari-pitch function (Refer to Reference Guide “SET UP screen/D.in Setup page”) is enabled.

⑤ MTC

This shows the status of MTC synchronization. If the AW4416 is following MTC messages from an external device, this will indicate “SLAVE.” If the AW4416 is transmitting MTC to an external device, this will indicate “MASTER”

⑥ Scene

This is the number of the currently selected scene (the current scene). When the mix parameters of the last stored or recalled scene are modified, an “E” (edited) character will be displayed at the lower right.

⑦ Level meters 1–16

These level meters show the input level and output level for each track 1–16 of the recorder section.

⑧ Level meter L/R

These level meters show the output level (the signal after passing through EQ and dynamics processing) of the stereo output channel.

⑨ REC READY indicator

This indicator will light red for tracks that are in record-ready mode.

⑩ INPUT MONITOR indicator

This indicator will light white for tracks whose input is being monitored.

⑪ Level display

The range of the display can be switched between two ranges: 0 to –60 dB (normal) and 0 to –26 dB (fine).

Basic operation of the AW4416

This section explains basic operation of the AW4416.

Accessing a screen/page

To operate the mix parameters of the AW4416 or to edit the internal settings, you must first access the desired screen in the display. If a screen contains two or more pages, you must then select the desired page.

□ Using the controls of the top panel

1. Press the key for the desired screen.

The keys of the WORK NAVIGATE, UNIT, MIXER, FADER MODE, RECORDER, and AUTOMATION sections of the top panel, and the [EDIT] key of the sample pad section each correspond to their own screens, which you can access by pressing the appropriate key.



.....
If a screen contains multiple pages, the most recently operated page will appear.

2. To switch pages within a screen, press the function key ([F1]–[F5] keys) that corresponds to the tab for the desired page.

Each tab corresponds to the following function key.

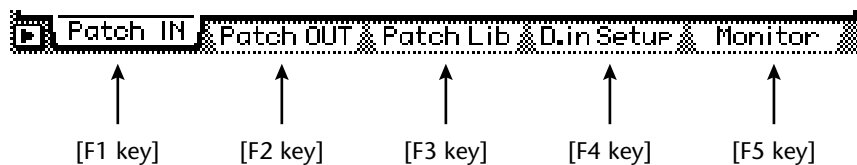

.....
By repeatedly pressing the same key you pressed in step 1, you can cycle through the pages of the screen.

□ Using the mouse

1. Click the M (menu) button in the upper right of the screen.

The display access menu will appear. From this menu you can use the mouse to select screens.

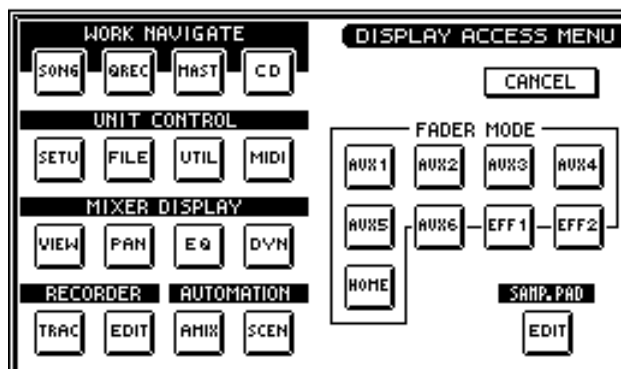

2. In the display access menu, click the button that corresponds to the desired screen.
3. To changes pages within the same screen, move the pointer to one of the tabs in the bottom of the screen, and click the left or right mouse button.

The corresponding page will appear.



Turning a button on/off

Here's how a button displayed in the screen can be turned on/off.

Using the controls of the top panel

1. Use the CURSOR [◀]/[▶]/[▲]/[▼] keys to move the cursor to the desired button.



< Move the cursor >

2. Press the [ENTER] key.
The button will be turned on or off.



< Switch on/off >

Using the mouse

1. Move the pointer to the desired button.



< Move the pointer >

2. Click the left or right button of the mouse.



< Switch on/off >

Editing the value of a fader/knob/numerical box

Here's how to edit the value of an on-screen fader/knob/numerical box.

□ Using the controls of the top panel

1. Use the CURSOR [◀]/[▶]/[▲]/[▼] keys to move the cursor to the desired fader/knob numerical box.

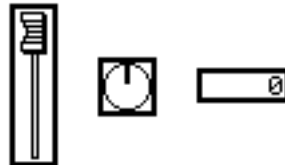

< Move the cursor >

2. Rotate the [DATA/JOG] dial to edit the value.



< Edit the value >

□ Using the mouse

1. Move the pointer to the desired fader/knob/numerical box, and click the left or right mouse button.

The cursor will change to a  shape.



< Click the fader/knob/numerical box >



Tip!

.....
 The amount by which the value changes will differ depending on whether you clicked the left or right mouse button. If you wish to change the value in large steps, click the right button. If you wish to change the value in fine steps, click the left mouse button.

2. Continue to hold down the mouse button, and drag the mouse up or down. The value will increase or decrease depending on the direction in which you drag the mouse.



< Drag the fader/knob/numerical box up or down >

Using the additional function buttons

In screens where the  symbol is displayed in the lower left, you can access additional buttons or tabs in the bottom of the display to use various additional functions.

□ Using the controls of the top panel

1. In a screen where the  symbol is displayed in the lower left, press the [SHIFT] key.

While you continue holding the [SHIFT] key, buttons for the additional functions will appear in the tab area at the bottom of the display.



< Additional function buttons >

2. Continue to hold down the [SHIFT] key, and press the function key ([F1]–[F5]) that corresponds to the desired button.

The function assigned to the corresponding button will be executed.

□ Using the mouse

1. In a screen where the  symbol is displayed, click the  symbol.

Buttons for the additional functions will appear in the tab area at the bottom of the display.



< Additional function buttons >



Tip!

When using the mouse, the additional function buttons will continue to be displayed even after you take your finger off of the mouse button.

2. Directly click one of the additional function buttons.

The function assigned to the corresponding button will be executed.

Inputting text

When you create a new song, or when you save the settings of a scene memory or library, a popup window will appear, allowing you to assign a name to the song or the settings. Here's how to input text into the popup window.

□ Using the controls of the tab page

1. Perform the scene or library Save operation, or create a new song.

If you perform the scene or library Save operation, a TITLE EDIT popup window will appear, allowing you to assign a name to the scene or library.

If you create a new song, a NAME EDIT popup window will appear, allowing you to assign a name to the song. Then a COMMENT EDIT popup window will appear, allowing you to add a comment to the song.

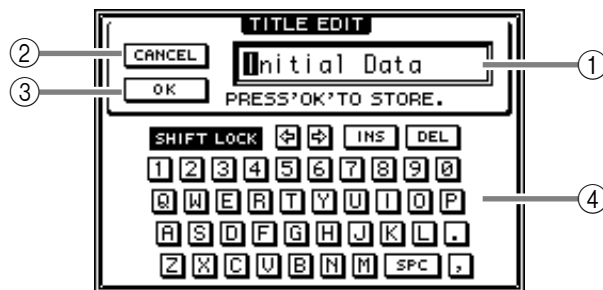

< TITLE EDIT popup window >



< NAME EDIT popup window >



< COMMENT EDIT popup window >

The items in each popup window and their function are as follows.

① **Text input box**

Characters, numerals, and symbols can be input in this box. When you create a new song or save for the first time, a default name will be input. The highlighted text indicates that it is being changed.



.....
Scene and library names can be up to 16 characters long. Song names and song comments can be up to 64 characters long.

② **CANCEL button**

If you move the cursor to this button and press the [ENTER] key, the procedure will be cancelled and you will return to the previous screen.

③ **OK button**

If you move the cursor to this button and press the [ENTER] key, the text you entered will be finalized. (If you are creating a new song, you will proceed to the next step of the procedure.)

④ **Text palette**

Here you can select the character to input in the text input box. The following characters, symbols, and numerals can be used.

A B C D E F G H I J K L M N O P Q R S T U V W X Y Z
 a b c d e f g h i j k l m n o p q r s t u v w x y z
 spc (space) 1 2 3 4 5 6 7 8 9 0 , . ! " # & / * - + < > ; :

2. Use the CURSOR [◀]/[▶]/[▲]/[▼] keys to move the cursor in the text palette to the button for the desired character, and press the [ENTER] key.

The corresponding character/symbol/numeral will be input into the text input box, and the highlighted area will move to the right.





.....
If you wish to correct a character that was input by mistake, you can use the [DATA/ JOG] dial to move the highlighted area to left or right.

3. Input the remaining characters in the same way.

While inputting text, you can use the following buttons in the text palette.

 button..... Insert a space (blank) at the highlighted area. Subsequent characters will be moved backward.

 button..... Delete the character at the highlighted area. Subsequent characters will be moved forward.

 /  buttons Move the highlighted area to left or right.

 /  buttons

(NAME EDIT, COMMENT EDIT windows only)..... Move the highlighted area upward or downward.

 button.. Switch between uppercase alphabet + numerals and lowercase alphabet + symbols. When this button is on, you can input uppercase alphabetical characters and numerals.

4. When you have finished inputting the desired text, move the cursor to the OK button, and press the [ENTER] key.

□ Using the mouse

1. Perform the scene or library Save operation, or create a new song.
If you perform the scene or library Save operation, a TITLE EDIT popup window will appear, allowing you to assign a name to the scene or library.
If you create a new song, a NAME EDIT popup window will appear, allowing you to assign a name to the song. Then a COMMENT EDIT popup window will appear, allowing you to add a comment to the song.
2. In the text palette, click the mouse on the button for the character that you wish to input.
The corresponding character/symbol/numeral will be input into the text input box, and the highlighted area will move to the right.



< Click a character button >



Tip!
If you wish to correct a character that you input by mistake, click the incorrect character to move the highlighted area to that location.

3. Input the remaining characters in the same way.



Tip!
When using the mouse, you can use the **INS** button, **DEL** button, **←/→** buttons, **↑/↓** (NAME EDIT/COMMENT EDIT windows only), or **SHIFT LOCK** button by clicking the corresponding button in the text palette.

4. When you have finished inputting the desired text, move the cursor to the OK button, and press the [ENTER] key.

Selecting channels

When editing the channel mix parameters on the AW4416, you must first select the channel that you wish to control. Here's how to select channels.

1. Use the keys of the MIXING LAYER section to select the mixing layer that you wish to control

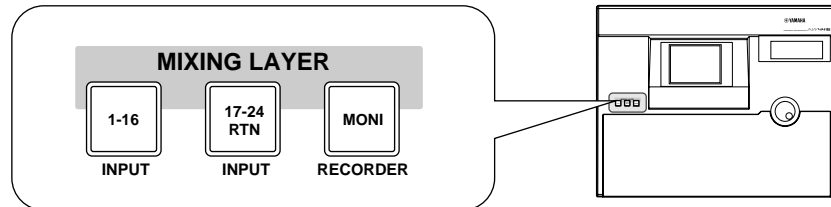

According to the selected key of the MIXING LAYER section, the channels controlled by the [SEL] keys, [ON] keys, and faders of the top panel will change as follows.

	1-8	9-14	15/16	STEREO
[1-16]	Input channels 1-16			Stereo output channel
[17-24 RTN]	Input channels 17-24	—	Effect return 1/2	
[MONI]	Monitor channels 1-16			

2. Press the [SEL] key of the channel you wish to control.
The [SEL] key of the corresponding channel will light.

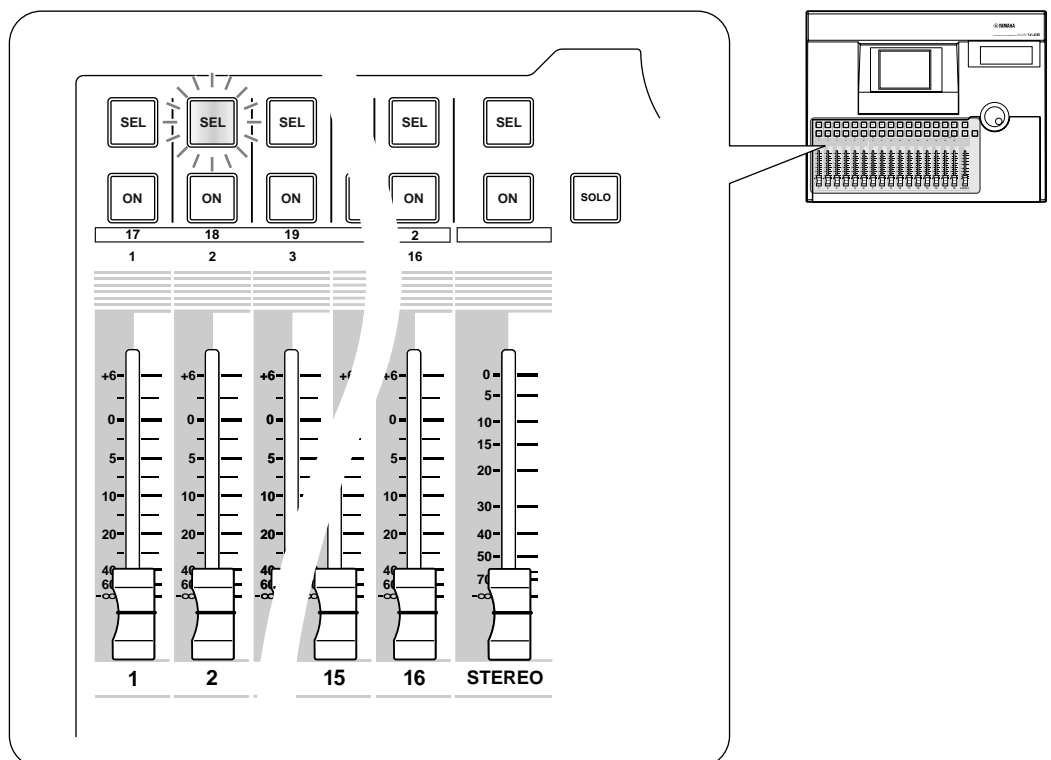

- Use the [PAN] control, EQ [Q]/[F]/[G] controls, and EQ [HIGH]–EQ[LOW] keys at the right of the display to adjust the pan and EQ of the channel that you selected by pressing its [SEL] key.

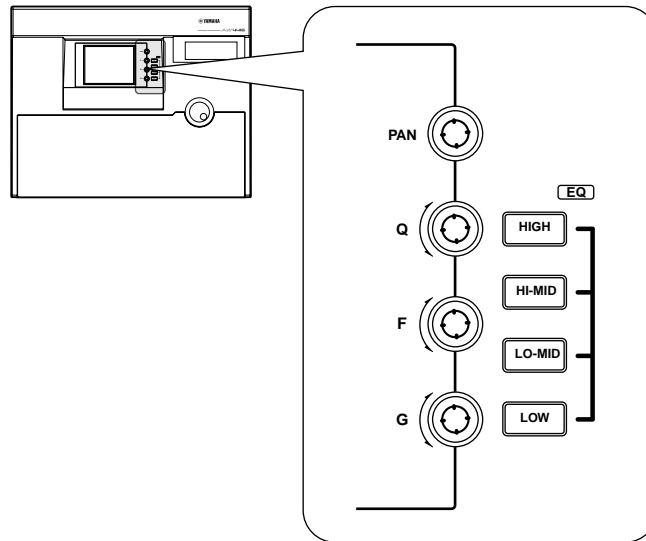

The controls and keys at the right of the display apply only to the channel that was last-selected by its [SEL] key.



Tip!
 If the VIEW, PAN, EQ, or DYN screens are shown in the display, you can control the parameters of the channel selected by its [SEL] key.

- To operate the faders, use the [HOME] key or [AUX 1]–[AUX 8] keys of the FADER MODE section to select the fader mode (the parameters that will be controlled by the faders).

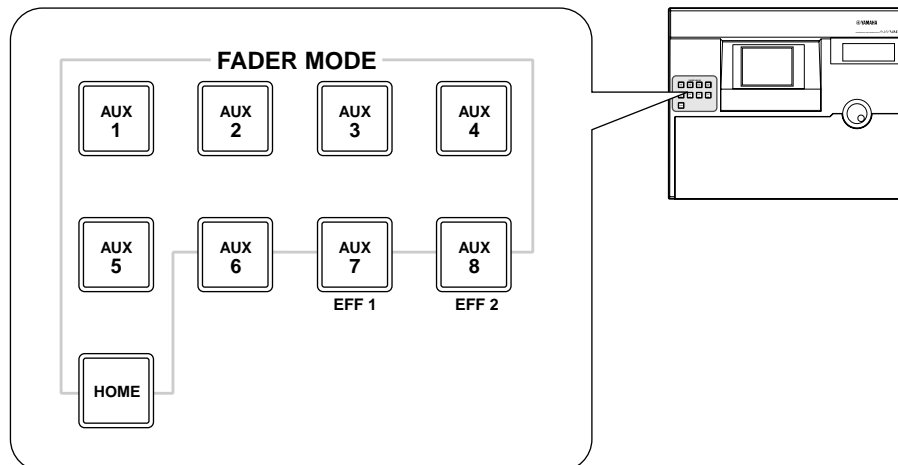

The table on the following page shows the parameters controlled by each fader will change.

○ If the mixing layer is [1-16]

Fader mode	Fader				
	1-8	9-14	15	16	STEREO
HOME	Input level of input channels 1-16				Output level of the stereo output channel
AUX1	Send level from input channels 1-16 to AUX 1				
AUX2	Send level from input channels 1-16 to AUX 2				
AUX3	Send level from input channels 1-16 to AUX 3				
AUX4	Send level from input channels 1-16 to AUX 4				
AUX5	Send level from input channels 1-16 to AUX 5				
AUX6	Send level from input channels 1-16 to AUX 6				
AUX7	Send level from input channels 1-16 to effect 1				
AUX8	Send level from input channels 1-16 to effect 2				

○ If the mixing layer is [17-24 RTN]

Fader mode	Fader				
	1-8	9-14	15	16	STEREO
HOME	Input level of input channels 17-24	—	Input level of effect return 1	Input level of effect return 2	Output level of the stereo output channel
AUX1	Send level from input channels 17-24 to AUX 1		Send level from effect return 1 to AUX 1	Send level from effect return 2 to AUX 1	
AUX2	Send level from input channels 17-24 to AUX 2		Send level from effect return 1 to AUX 2	Send level from effect return 2 to AUX 2	
AUX3	Send level from input channels 17-24 to AUX 3		Send level from effect return 1 to AUX 3	Send level from effect return 2 to AUX 3	
AUX4	Send level from input channels 17-24 to AUX 4		Send level from effect return 1 to AUX 4	Send level from effect return 2 to AUX 4	
AUX5	Send level from input channels 17-24 to AUX 5		Send level from effect return 1 to AUX 5	Send level from effect return 2 to AUX 5	
AUX6	Send level from input channels 17-24 to AUX 6		Send level from effect return 1 to AUX 6	Send level from effect return 2 to AUX 6	
AUX7	Send level from input channels 17-24 to effect 1		—	Send level from effect return 2 to effect 1	
AUX8	Send level from input channels 17-24 to effect 2		Send level from effect return 1 to effect 2	—	

○ If the mixing layer is [MONI]

Fader mode	Fader				
	1-8	9-14	15	16	STEREO
HOME	Input level of monitor channels 1-16				Output level of the stereo output channel
AUX1	Send level from monitor channels 1-16 to AUX 1				
AUX2	Send level from monitor channels 1-16 to AUX 2				
AUX3	Send level from monitor channels 1-16 to AUX 3				
AUX4	Send level from monitor channels 1-16 to AUX 4				
AUX5	Send level from monitor channels 1-16 to AUX 5				
AUX6	Send level from monitor channels 1-16 to AUX 6				
AUX7	Send level from monitor channels 1-16 to effect 1				
AUX8	Send level from monitor channels 1-16 to effect 2				

4 Connections and setup

This chapter explains how to connect external devices and set up your system before you begin using the AW4416.

Connections

The following diagram shows typical audio connections for the AW4416.

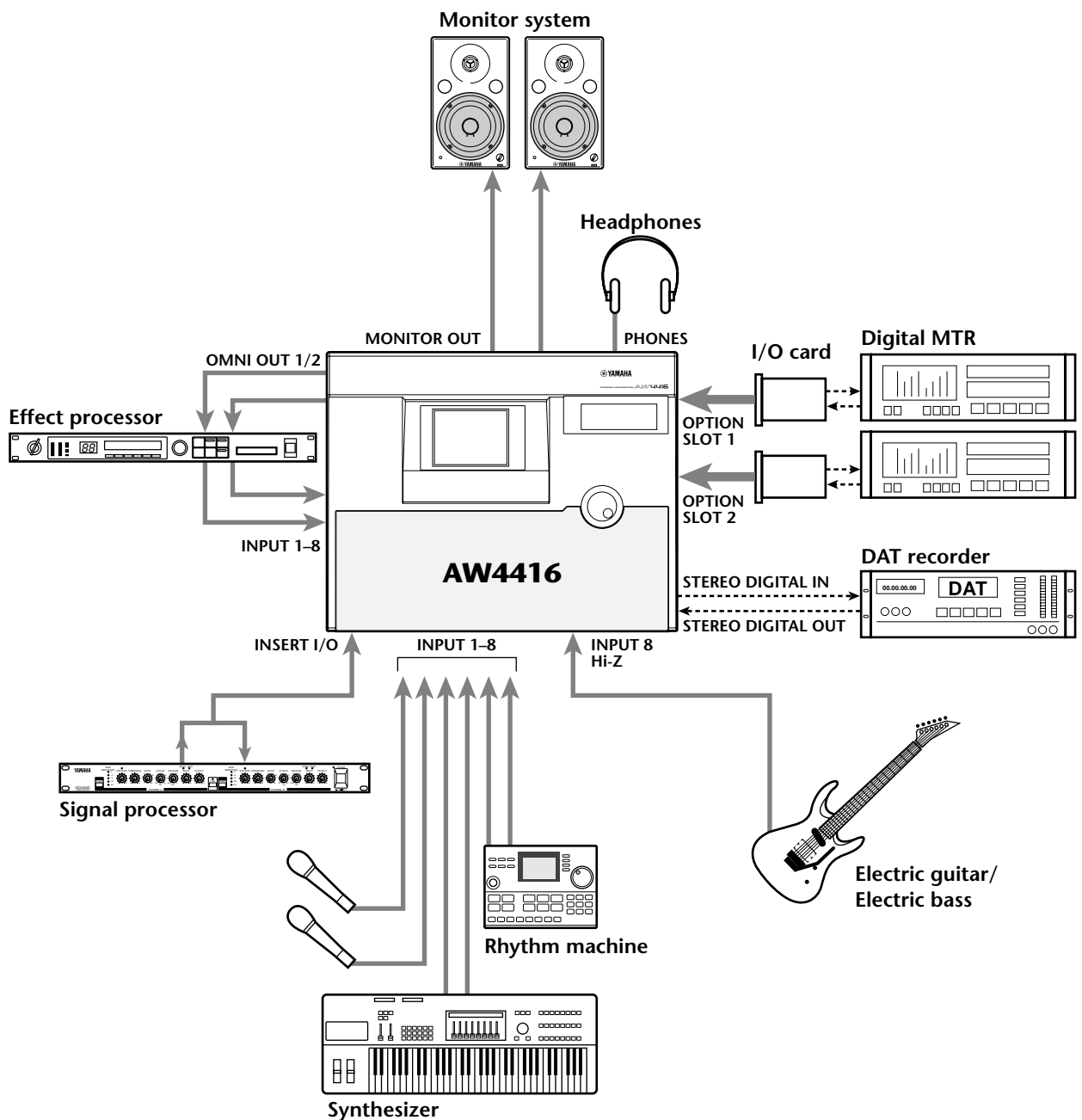

Word clock settings

If a device such as a digital MTR or DAT recorder is digitally connected to the AW4416, the clock that controls the timing at which digital audio is processed (referred to as the “word clock”) must be synchronized. To do so, you must select one of the devices as the word clock master, and set the remaining devices so that they will follow the word clock supplied from the master device. Here we will explain how to select the clock source to which the AW4416 will synchronize.



Be aware that if the system includes an unsynchronized device, drop-outs and click noise will occur.

1. Turn on the power of the external digital device and of the AW4416.



If an external device is connected to the SCSI connector of the AW4416, you must turn on the power in the order of external SCSI device → AW4416. If the power of the external SCSI device is off when you turn on the AW4416, it may not start up correctly.



If the D.in Setup tab is not assigned to the [F4] key when you press the [SETUP] key, press the [SHIFT] key + [F1] key to switch the tab, and then press the [F4] key.

2. Press the [SETUP] key → [F4] key.

The SETUP UP screen D.in Setup page will appear, allowing you to make word clock settings.

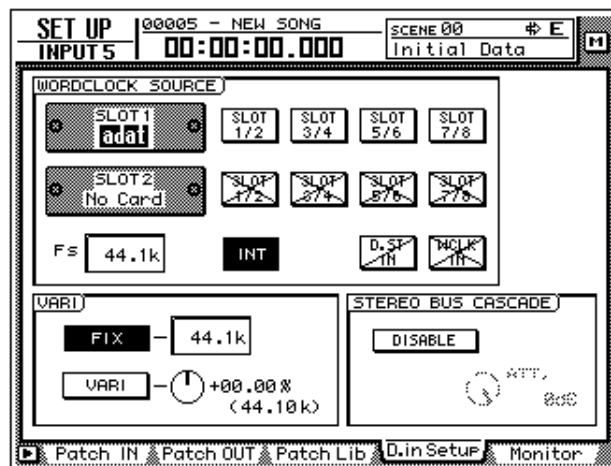

In the WORD CLOCK SOURCE area of this screen you can select one of the following as the clock source to which the AW4416 will synchronize.

- SLOT 1 1/2–7/8
- SLOT 2 1/2–7/8

An input signal from a digital I/O card installed in OPTION I/O slot 1/2 will be the clock source. You can select one pair from input channels 1/2–7/8 of the digital I/O card, and the AW4416 will synchronize to the word clock data included in the input signal of the corresponding channel.

○ D.ST IN

The word clock data included in the input signal from the DIGITAL STEREO IN jack will be the clock source.

○ WCLK IN

The word clock data included in the input signal from the WORD CLOCK IN jack will be the clock source.

○ INT

The internal clock of the AW4416 will be the clock source.



The currently highlighted button is selected as the word clock source.



Buttons marked with an × symbol indicate that no digital audio signal is being input from the corresponding slot/jack.



Buttons marked with a / symbol indicate that either no digital audio signal is being input from the corresponding slot/jack, or that it is not synchronized with the AW4416's internal clock.



Buttons without an × or / symbol indicate that a digital audio signal is being input from the corresponding slot/jack, and that it is synchronized with the AW4416's internal clock.



.....
If the AW4416 is set to be an MTC slave, it is not possible for the AW4416 to simultaneously be set as the word clock slave.

3. Select the desired clock source in the WORD CLOCK SOURCE area by using the CURSOR [◀]/[▶]/[▲]/[▼] keys to move the cursor to the corresponding button.

The clock source you should select will depend on the system in which you are using the AW4416. Here we will explain some typical situations.

○ Using the AW4416 as the word clock master

If no external digital device is connected to the AW4416, or if you wish to use the AW4416 as the word clock master so that external devices such as a digital MTR will follow it, turn on the INT button of the WORD CLOCK SOURCE area.

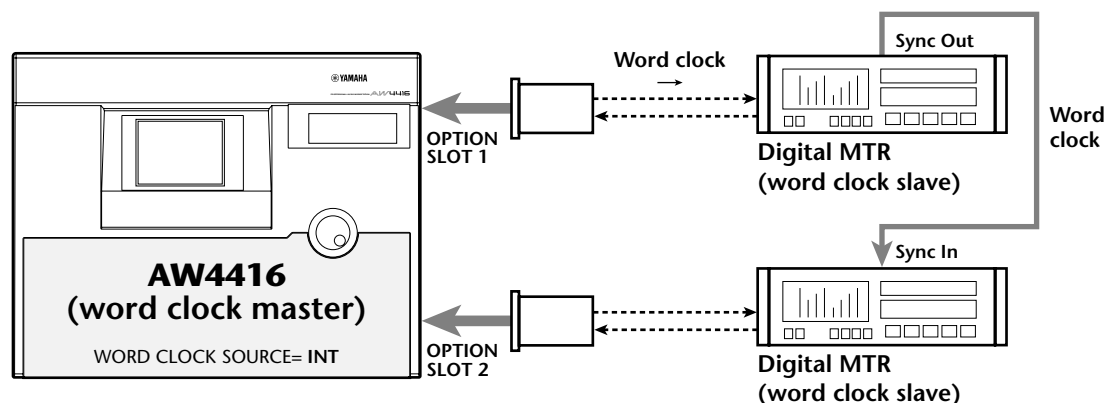

- Set the digital MTR so that it will synchronize to the word clock included in the input signal from the AW4416.
- If you are using two digital MTR units, connect the Sync Out jack of the first to the Sync In jack of the second as shown here, so that the second digital MTR will follow the first.

○ Using a digital MTR as the word clock master (1)

This method uses a digital MTR as the word clock master, and causes the AW4416 to synchronize to the word clock included in the input signal from the digital I/O card. For this method, turn on one of the 1/2–7/8 buttons for the slot to which that digital MTR is connected.

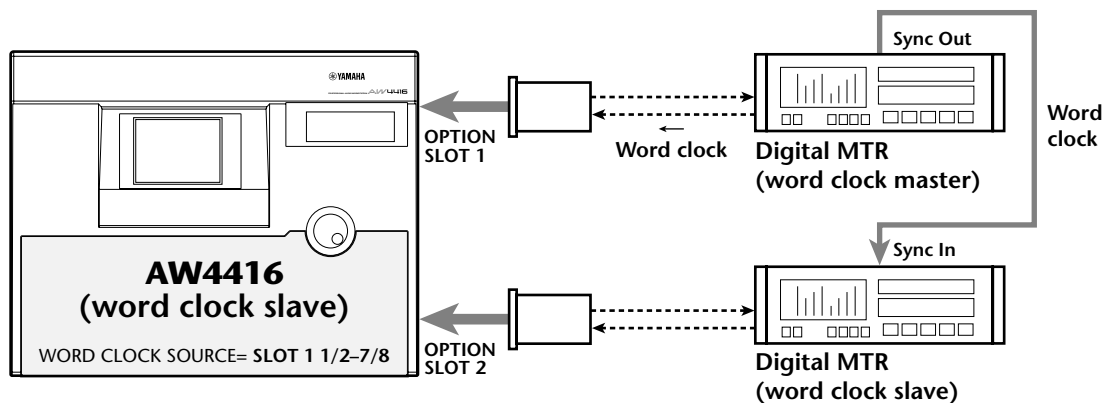

- Set the digital MTR so that it will operate according to its own internal clock.
- If you are using two digital MTR units, connect the Sync Out jack of the first to the Sync In jack of the second as shown here, so that the second digital MTR will follow the first.

○ Using a digital MTR as the word clock master (2)

This method uses a digital MTR as the word clock master, and causes the AW4416 to synchronize to the word clock supplied from the word clock output jack of the digital MTR to the WORD CLOCK IN jack of the AW4416. For this method, turn on the WCLK IN button.

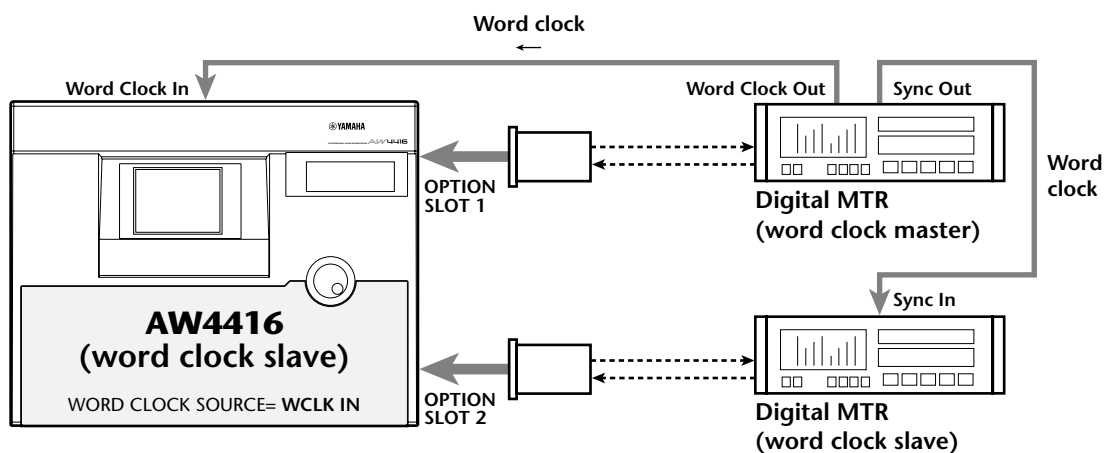

- Set the digital MTR so that it will operate according to its own internal clock.
- If you are using two digital MTR units, connect the Sync Out jack of the first to the Sync In jack of the second as shown here, so that the second digital MTR will follow the first.

○ Using a DAT recorder as the word clock master

If you wish to input a digital signal from a DAT recorder or sampler etc. into the AW4416 via the DIGITAL STEREO IN jack, turn on the D.ST IN button.

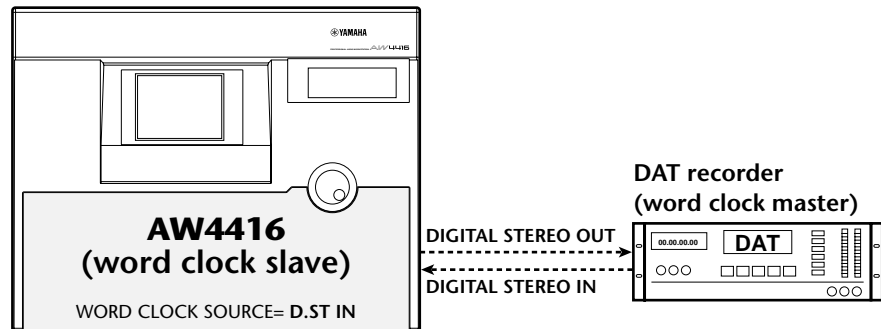

- Set the DAT recorder so that it will operate according to its own internal clock.



.....

Most consumer DAT recorders are designed to forcibly follow the word clock of the input signal when recording. This type of DAT recorder can be used as the word clock master only when it is playing back.

4. After selecting the desired button, press the [ENTER] key.

The AW4416 will switch to the specified clock source.



-
- A slight interval of time is required for the AW4416 to select clock sources, and the sound may be muted during this time.
 - After switching the clock source, verify that the button you selected in step 3 is not marked with an X symbol or / symbol. If an X symbol or / symbol appears on the button, or if an error message is displayed, check the connections or the clock setting of the external device.

5 Recording on the AW4416

This chapter explains basic operation for performing multitrack recording and mixdown on the AW4416, using the example of recording instruments such as rhythm machine (drums), bass, guitar, and keyboard on their own tracks.

Preparations for recording

Connections and start-up

Here's how to connect your instruments and monitor system, and start up the AW4416.

1. Connect your instruments, mics, and monitor system to the AW4416 as shown in the following diagram.

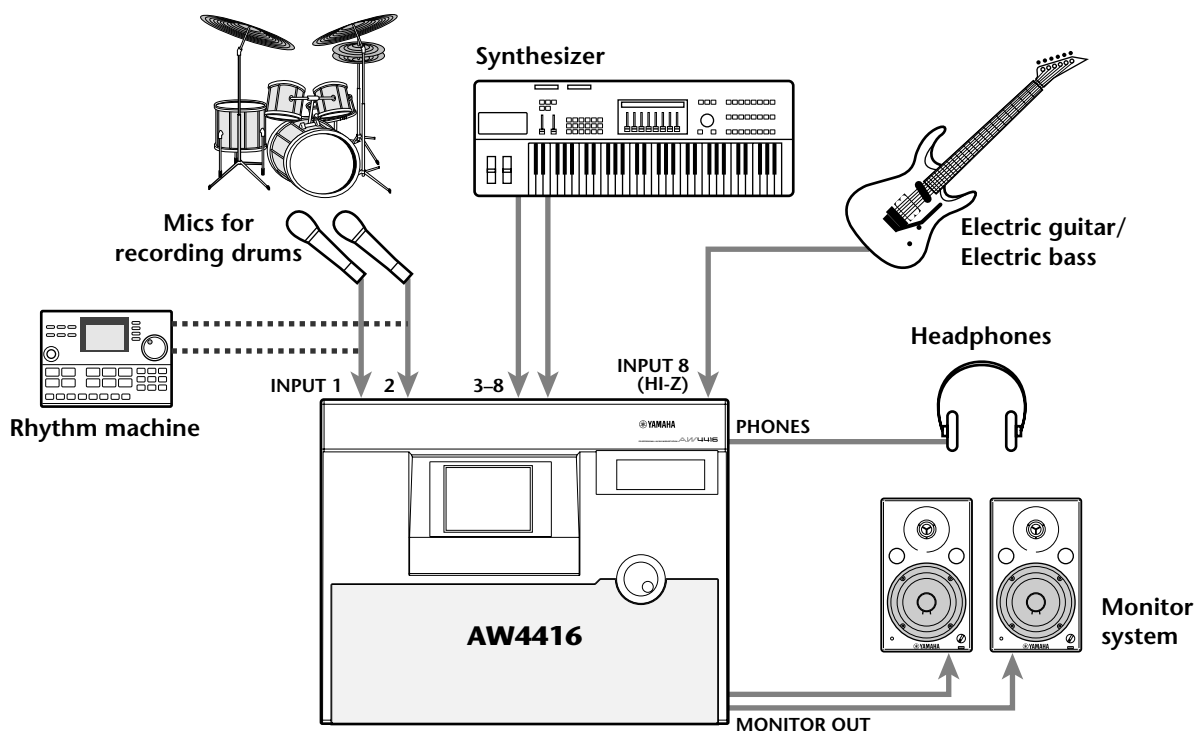

Connect mics, synthesizers or rhythm machines, direct boxes, or guitar/bass preamps to the INPUT 1/2 (XLR) jacks or INPUT 1-8 (phone) jacks, according to the type of their output connector.

When directly connecting instruments with a high output impedance, such as passive type electric guitars or electric basses, connect them to the INPUT 8 (HI-Z) jack.

- Turn on the power in the following order: audio sources/SCSI devices connected to the AW4416 → the AW4416 → monitor system.

The display of the AW4416 will show the opening screen, and will then change to the TRACK screen TR View page.

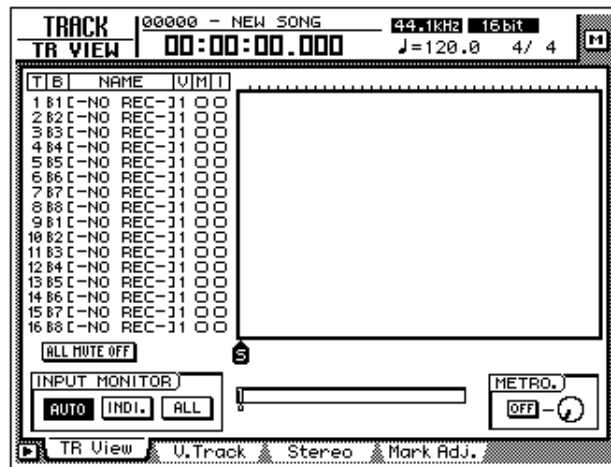

When the power of the AW4416 is turned on, the song you were last operating will be loaded automatically.



- If the internal hard disk of the AW4416 has not been formatted, a message of "Format OK? [Y (Enter)/N (Any)]" will appear instead of the above screen when the power is turned on.
- If a SCSI device is connected to the AW4416, and you turn on the power of the AW4416 when the SCSI device is turned off, it may not start up correctly. If the SCSI device is turned on after the AW4416 is turned on, it will not function correctly.

Creating a new song

On the AW4416, all data (mixer settings, recorder settings, audio data etc.) necessary for reproducing a musical work are stored on the hard disk as a unit called a “song.” In order to record, you must begin by creating a new song.



.....
A new 44.1 kHz/16 bit song is created when the internal hard disk is formatted, and will automatically be loaded the next time you turn on the power of the AW4416. If you wish to use this song, the following procedure is not necessary.

1. Press the [SONG] key → [F1] key.

The SONG screen Song List page will appear. In this page you can create a new song, and save/load existing songs.

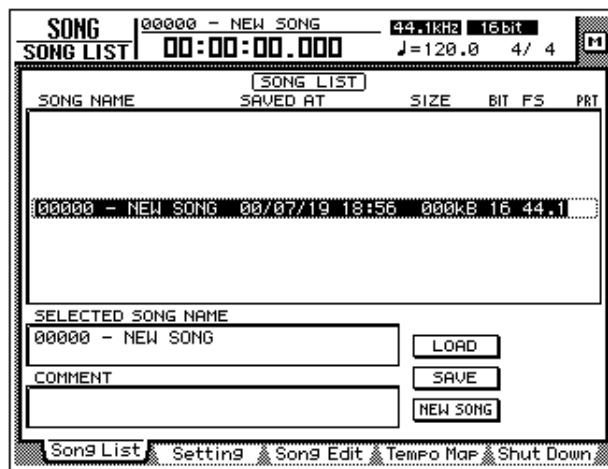

2. Use the CURSOR [◀]/[▶]/[▲]/[▼] keys to move the cursor to the NEW SONG button in the lower right of the screen, and press the [ENTER] key.

A popup window will appear, asking you whether you wish to save the song you are now working on (referred to as the “current song”).

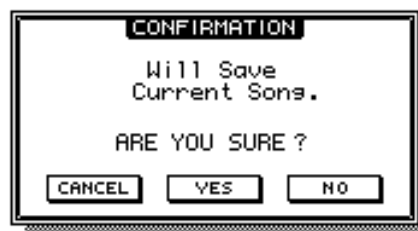

3. Move the cursor to the YES button to save the current song, or to the NO button if you do not wish to save it. Then press the [ENTER] key. The NEW SONG SETTING popup window will appear. In this popup window you can specify the basic settings for the new song.

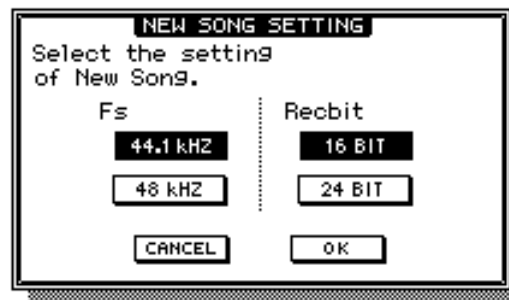

○ Fs

This is the sampling frequency at which the input signals are converted into digital form. Move the cursor to either the 44.1 kHz or 48 kHz button, and press the [ENTER] key to make your selection.

○ Reccbit

This is the number of quantization bits for the audio data recorded on the hard disk. Move the cursor to either 16 BIT or 24 BIT, and press the [ENTER] key to make your selection.



- It is not possible to change the sampling frequency or quantization after creating a song.
- The number of tracks that can be simultaneously played or recorded will depend on the specified quantization.
- If you intend to use a CD-RW drive to create an audio CD of your song when it is completed, you must select 44.1 kHz as the sampling frequency. A song with a sampling frequency of 48 kHz cannot be recorded on an audio CD.

4. After you have selected the sampling frequency and the quantization, move the cursor to the OK button and press the [ENTER] key. The new song will be created.

If you selected 48 kHz as the sampling frequency, the display will indicate “Not for Audio CD -48 kHz- ARE YOU SURE?”, warning you that an audio CD cannot be produced from this song. Move the cursor to either the OK button or the CANCEL button, and press the [ENTER] key.

The MIXER DATA IMPORT popup window will appear. This popup window allows you to import mixer data from an existing song. For this example, it is not necessary to make any settings.





Mixer data import, name edit, and comment edit operations can also be performed later in the SONG screen Song Edit page or SONG screen Setting page, as an alternative to performing them here when you create a new song.

5. Make sure that the cursor is located at the OK button, and press the [ENTER] key.

The NAME EDIT popup window will appear, allowing you to assign a name to the song.

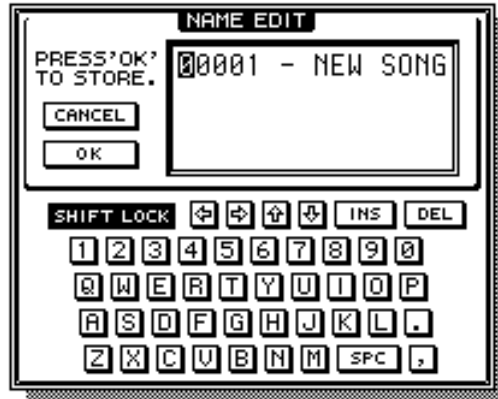

6. Use the character palette to assign a song name of up to 64 characters. (For details on inputting characters, refer to page 60.) When you have finished inputting the song name, move the cursor to the OK button and press the [ENTER] key.

The COMMENT EDIT popup window will appear, allowing you to assign a comment to the song.



7. As desired, input a comment in the same way as the song name. Then move the cursor to the OK button and press the [ENTER] key.

Recording the first tracks

This section explains the procedure for recording a rhythm machine (or drum mics) connected to INPUT jacks 1/2 onto tracks 1/2 of the recorder.



The explanation in this section assumes that the AW4416's mixer and patching settings are in their initial state. If you have already modified the mixer parameters or the input/output patching, please recall the default scene (scene number 00) from the scene memory (→ P.206).

Set the input level

1. While producing sound on your instrument, adjust [GAIN] controls 1/2 so that the PEAK indicators of INPUT jacks 1/2 light briefly when the loudest sounds are played.

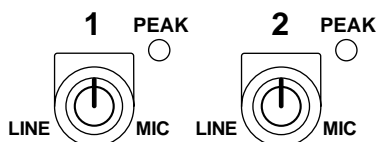

The [GAIN] control adjusts the sensitivity of the analog input. In order to record the sound cleanly and with the widest possible range, you should adjust the [GAIN] as high as possible without allowing clipping to occur.

2. Press the [HOME] key → [F1] key
The HOME screen 1–24/Rtn page will appear. This page shows the input levels of input channels 1–24 and return channels 1/2.

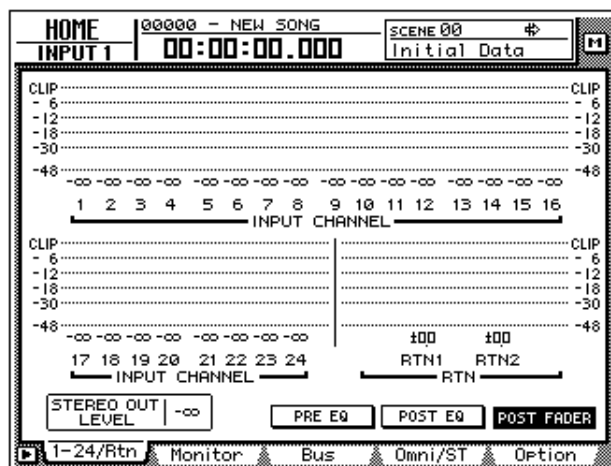

3. In the MIXING LAYER section, press the [1–16] key to select input channels 1–16 as the mixing layer.



When you switch mixing layers, the faders will move instantly to new positions. Be careful not to place objects near the faders.

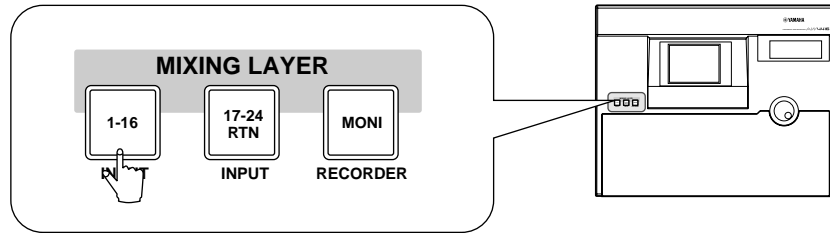

The “mixing layer” is the group of channels controlled by the top panel [ON] keys 1–16, [SEL] keys 1–16, and faders 1–16. The AW4416 has the following three mixing layers:

- ① **Input channels 1–16**
- ② **Input channels 17–24 + return channels**
- ③ **Monitor channels**

Even when you switch to a different mixing layer, the fader locations and [ON] key settings of the previous mixing layer are remembered, and will return when that mixing layer is selected once again.

4. Make sure that [ON] keys 1/2 are turned on, and raise faders 1/2 to the 0 dB position.
5. While playing your instrument, watch the level meters displayed in the screen and adjust the input level of inputs 1/2.

When the AW4416 is in the initial state, the input jacks are patched to input channels as follows. As you can see from this diagram, the rhythm machine (or drum mics) connected to INPUT jacks 1/2 are patched to input channels 1/2.

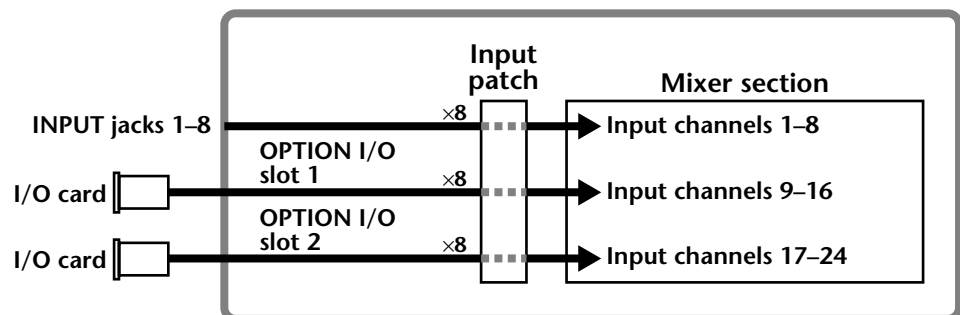

Now raise the faders of input channels 1/2 and check that the signals are being input. If the level meters reach the “CLIP” position, you should lower [GAIN] controls 1/2.



The patching of the input jacks and input channels can be changed freely. For details refer to page 133.

6. If you wish to set the input signals of INPUT jacks 1/2 as a stereo pair, hold down [SEL] key 1 and press [SEL] key 2.

Adjacent odd-numbered → even-numbered input channels can be specified as a stereo pair. You will find it convenient to pair two channels that are inputting a stereo source, so that all mix parameters except for phase and pan will be linked. However, Effect Insert will not be linked.

When you simultaneously press the two [SEL] keys, a CHANNEL PAIRING popup window will appear, allowing you to specify how pairing will occur.

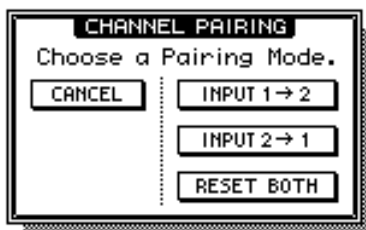

7. Move the cursor to either the “INPUT 1→2,” “INPUT 2→1,” or “RESET BOTH” button, and press the [ENTER] key.

One of the following can be selected as the pairing method.

INPUT $x \rightarrow y$ (x =odd number, y =even number)

The parameters (except for phase and pan) of the odd-numbered channel will be copied to the even-numbered channel.

INPUT $y \rightarrow x$ (x =odd number, y =even number)

The parameters (except for phase and pan) of the even-numbered channel will be copied to the odd-numbered channel.

RESET BOTH

The parameters of both channels will be reset to their initial settings.

Assign the signals to buses

When the AW4416 is in the initial state, bus outputs 1–8 of the mixer section are patched as follows to tracks 1–16 of the recorder. In our example here, we will assign the signal from the rhythm machine (or drum mics) input via input channels 1/2 to buses 1/2 and send them to tracks 1/2 of the recorder.

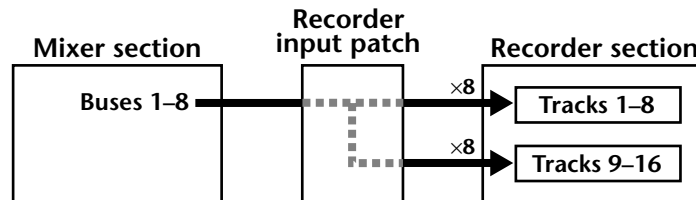

1. Press the [PAN] key → [F1] key.

The PAN/ROUTE screen Pan 1–16 page will appear. In this page you can assign input channels 1–16 to buses (stereo bus, buses 1–8) and make pan settings.

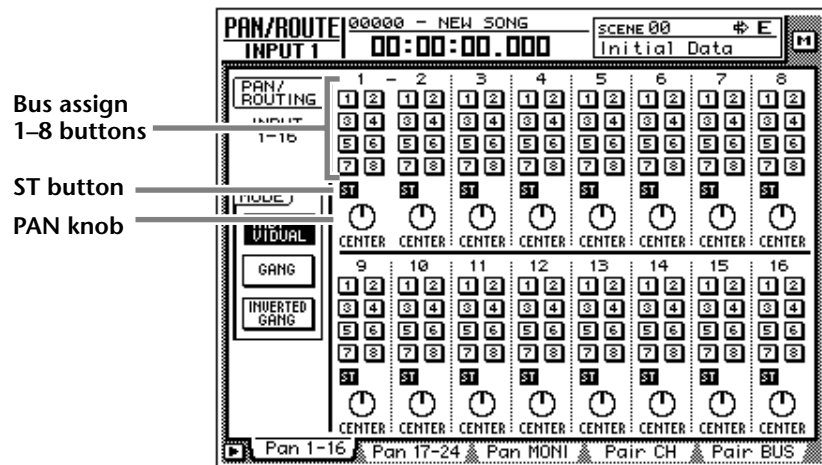

2. Use the CURSOR [◀]/[▶]/[▲]/[▼] keys to move the cursor to the input channel 1 area. Turn the ST button off, and turn the bus assign 1/2 buttons on.

With these settings, the signal of input channel 1 will not be sent to the stereo bus, but will be sent instead to buses 1–2. The ST button and bus assign 1/2 buttons of input channel 2 (which is paired with input channel 1) will follow these settings.



To switch an on-screen button on/off, move the cursor to the button and press the [ENTER] key.

3. Move the cursor to the PAN knob of input channel 1, and use the [DATA/JOG] dial to set the pan to far left (L16).

The PAN knob sets the stereo position between the L/R channels of the stereo bus, and pans between odd-numbered buses and even-numbered buses of bus 1–8. In this example, the signal will be sent only to bus 1 if you rotate the PAN knob to the far left.



Note that the level when the PAN knob is positioned at full left or full right will differ between paired and unpaired channels.
The level of a channel that is not paired will rise 3 dB when the PAN knob is positioned at full left (L16) or full right (R16).

- In the same way, move the cursor to the input channel 2 area, and set the PAN knob to far right (R16).



Even for paired channels, the PAN knobs will not operate in tandem if the MODE area Pan parameter is set to INDIVIDUAL (default setting). The PAN knobs will move in tandem if this parameter is set to GANG or INVERTED GANG.

Set the tracks to record-ready mode

Next we will set tracks 1/2 of the recorder to record-ready mode, and adjust the input level of each track.

- In the level meters/counter section, press [REC TRACK SELECT] keys 1 and 2.

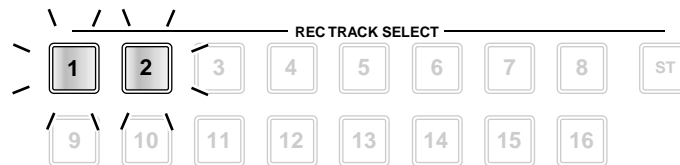

[REC TRACK SELECT] keys 1 and 2 will begin blinking. In the level meters/counter section, REC READY indicators 1 and 2 will blink red. This indicates that tracks 1/2 are in record-ready mode.

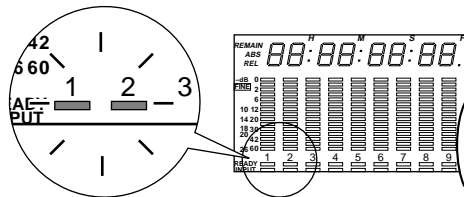

- While producing sound on your instrument, watch level meters 1/2 in the level meters/counter section.

The level of the signals being input to tracks 1/2 (which are in record-ready mode) will be shown in level meters 1/2. If the red segment at the 0 dB position lights for level meters 1/2, lower faders 1/2 (input channel 1/2 input levels).

In this example, tracks 1/2 are paired, so be sure to operate only one of the faders.



When the AW4416 is in its initial state, the input monitor mode of each track is set to "AUTO." For tracks that are currently in record-ready mode, the level meters will show the level of the input signal while the recorder is stopped, and the level of the track playback signal when the recorder is playing back.



When tracks are paired, you must operate only one of the faders. Attempting to move both faders simultaneously will place a strain on the motor, and may cause malfunctions.

Make monitor settings

Now we will send the signal of monitor channels 1/2 to the stereo bus, so that it can be monitored via the MONITOR OUT jacks or the PHONES jack.

1. Press the [PAN] key → [F3] key.

The PAN/ROUTE screen Pan MONI page will appear. In this page you can make bus assignments and pan settings for monitor channels 1–16.

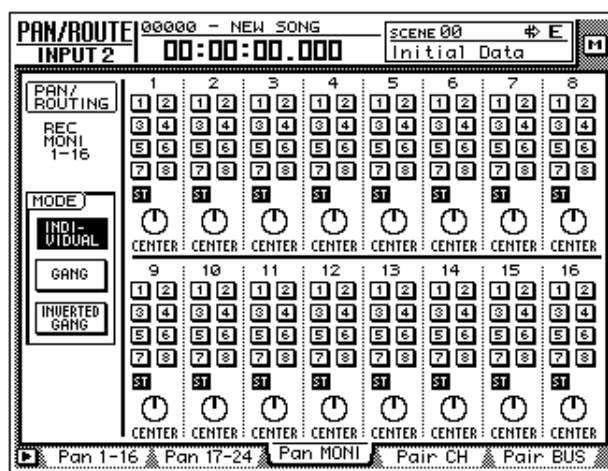

2. Press the [MONI] key.

Monitor channels 1–16 will be selected as the mixing layer.

3. Hold down [SEL] key 1, and press [SEL] key 2.

Just as we did for input channels 1/2, we will also pair monitor channels 1/2. When you simultaneously hold down the monitor channel 1/2 [SEL] keys, the CHANNEL PAIRING popup window will appear.

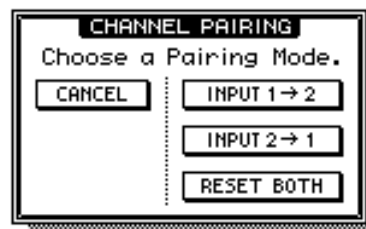

4. Move the cursor to one of the three buttons and press the [ENTER] key. Monitor channels 1/2 will be paired.

5. In the monitor channel 1/2 area, make sure that the ST buttons are on and the 1–8 buttons are off.

With these settings, the signal of the monitor channels will be sent to the stereo bus.

6. In the same way as for the input channels, set the PAN knobs of monitor channels 1/2 to far left (L16) for channel 1 and far right (R16) for channel 2.
7. Make sure that [ON] keys 1/2 and the STEREO [ON] key are on, and raise faders 1/2 and the STEREO fader to the 0 dB position.



.....

When tracks are paired, you must operate only one of the faders. Attempting to move both faders simultaneously will place a strain on the motor, and may cause malfunctions.

8. While producing sound on your instrument, watch the L/R level meters of the level meter/counter.

The signal from the rhythm machine (or drum mics) will be sent via tracks 1/2 → monitor channels 1/2 to the stereo bus. If the red 0 dB segment lights, lower faders 1/2 (input level of monitor channels 1/2).

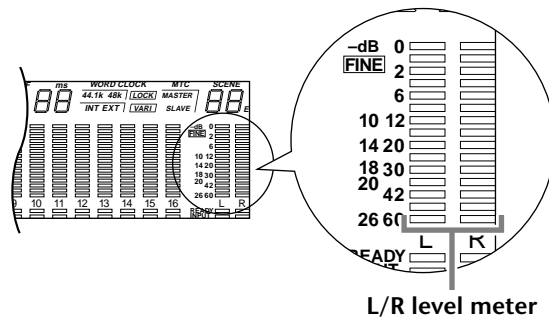

9. Raise the MONITOR OUT control/PHONES control.

You can monitor the input signal via your monitor system or headphones.



.....

Note that the signals being controlled here are not the signals recorded on the recorder; rather, they are the signals passing through the recorder. Operating the pan, fader, or [ON] key of a monitor channel will not affect the signal that is recorded.

Let's record!

1. Press the Locate section [RTZ] key.

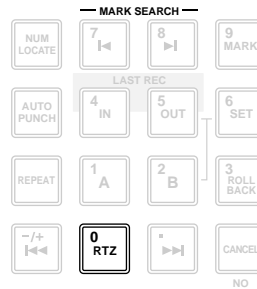

The level meter/counter and the display counter will rewind to zero (00:00:00.000).



With the default settings of the song, hours (hours/minutes/seconds/milliseconds) are selected as the counter unit of the level meter/counter and display counter. However you may switch this to time code display (hours/minutes/seconds/frames/sub-frames) or measure display (measure/beat/tick) if desired.

2. To begin recording, hold down the Transport section [REC] (●) key and press the [PLAY] (▶) key.

The [REC] key and [PLAY] key will light, and the red REC READY indicators of the [REC TRACK SELECT] keys 1/2 and the level meter/counter will change from blinking to lit.



When you attempt to record the signal being input from the DIGITAL STEREO IN jack, the display may sometimes indicate "DIGITAL-ST-IN-PROHIBIT," and you will be unable to perform step 2. In this case, go to UTILITY screen Prefer.2 page ([UTILITY] key → [F3] key), and set CD/DAT DIGITAL REC to ENABLE. (For details refer to Reference Guide "UTILITY" screen.)

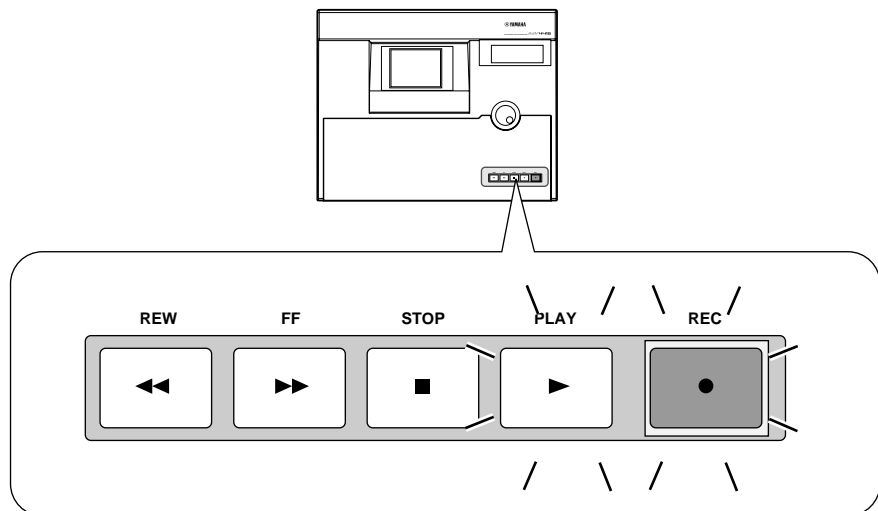



.....

If the following keys are on, the keys of the Locate section and the Transport section will have no effect. (Alternatively, the functions assigned to the keys will change.) Select a different key before you continue with this procedure.

- WORK NAVIGATE section: [SONG] key, [MASTERING] key, [CD PLAY] key
- UNIT section: [FILE] key
- RECORDER section: [EDIT] key
- SAMPLING PAD section: [EDIT] pad (except for when the Trig.List page is displayed)

3. Start the rhythm machine (drum) performance.
4. When the performance is finished, press the [STOP] (■) key.
5. To listen to the recorded content, press the Locate section [RTZ] key, and then press the Transport section [PLAY] (▶) key.
6. When you are satisfied with the recorded content, press the [STOP] (■) key to stop the transport. Then press [REC TRACK SELECT] keys 1/2 to defeat record-ready mode for tracks 1/2.



Tip!

-
- By using the [ALL SAFE] key instead of step 6, you can cancel record-ready mode in one operation.
 - If you wish to re-do the recording, repeat steps 1–4.
 - We recommend that you save the song whenever you take a break from your work. (→ P.106)

Overdubbing

In this section we will explain how to record an electric bass connected to INPUT 8 (HI-Z) jack while monitoring the rhythm machine (or drums) recorded on tracks 1/2.

Set the input level

1. While producing sound on your instrument, adjust [GAIN] control 8 so that the PEAK indicator of INPUT 8 (HI-Z) lights briefly when you play most loudly.



.....
The INPUT 8 (HI-Z) jack is an input jack designed for high impedance instruments. It cannot be used simultaneously with the conventional INPUT 8 (phone) jack.

2. Press the [HOME] key → [F1] key.
 The HOME screen 1–24/Rtn page will appear.

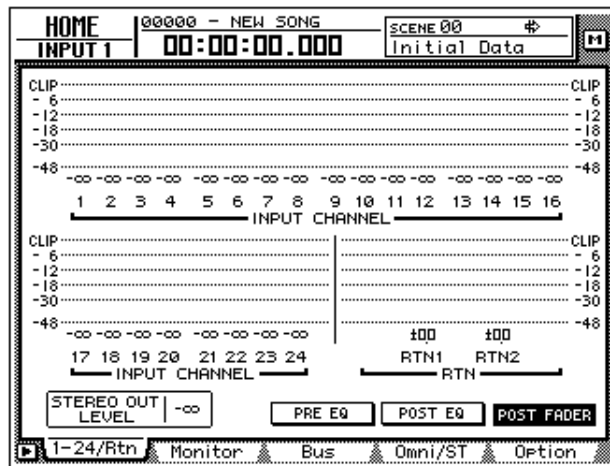

3. Press the MIXING LAYER section [1–16] key to select input channels 1–16 as the mixing layer.
4. Make sure that [ON] key 8 is turned on, and raise fader 8 to the 0 dB position.



.....
To avoid confusion, turn off the [ON] keys for all input channels that you are not using.

5. While producing sound on your instrument, watch the input level of input channel 8 that is displayed in the on-screen level meter.
 If the AW4416 is in the initial state, the electric bass connected to the INPUT 8 (HI-Z) jack will be sent to input channel 8. If the level meter reaches the “CLIP” position, lower [GAIN] control 8.

Assign the signal to a bus

Here we will make settings so that the electric bass signal being input from input channel 8 will be sent to recorder track 3 via bus 3.

1. Press the [VIEW] key → [F1] key.

The VIEW screen CH View page will appear. The CH View page shows all mix parameters of the currently selected channel. (Major parameters can also be operated here.) It is convenient to use this page when you wish to control all the mix parameters of a specific channel.

In the preceding section “Recording the first track,” we used the PAN/ROUTE screen to set bus assignments and pan for multiple channels at once. Here, however, we are going to use the VIEW screen CH View page to perform the same operations.

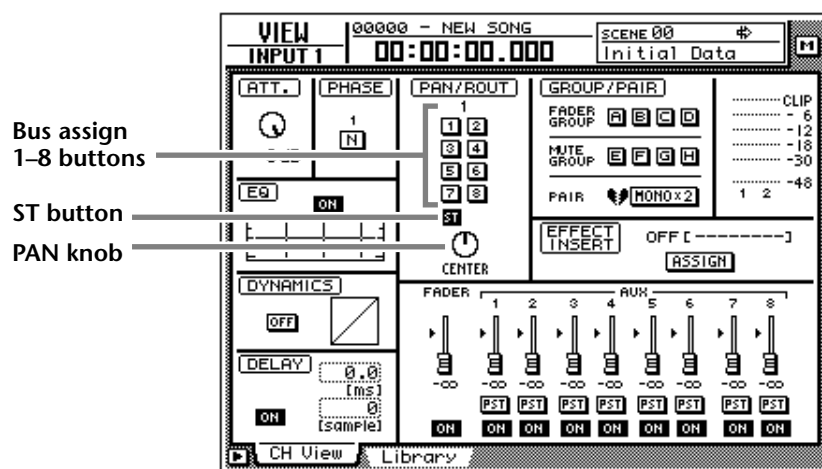

2. In the MIXING LAYER section, press the [1-16] key → [SEL] key 8.

On the AW4416, you select the channel to be controlled by selecting a mixing layer in the MIXING LAYER section, and then pressing a [SEL] key to select a channel. When you are using the CH View page, the currently selected channel will be shown in the upper left of the display. The corresponding [SEL] key will also light.



3. Move the cursor to the PAN/ROUTE area. Turn the ST button off and the bus assign 3 button on.
4. Make sure that the PAN/ROUTE area PAN knob is positioned in the center (CENTER).

With these settings, the signal of input channel 8 will no longer be sent to the stereo bus, but will be sent to bus 3 instead.



Note that the level of a channel that is not paired will rise 3 dB when the PAN knob is positioned at full left (L16) or full right (R16).

Put the track in record-ready mode

Next we will put track 3 of the recorder in record-ready mode, and adjust the input level.

1. In the level meters/counter section, press [REC TRACK SELECT] key 3.

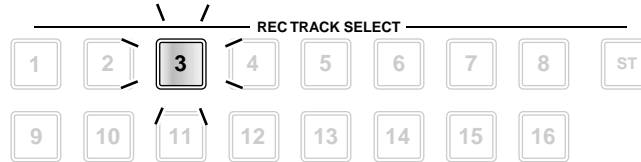

[REC TRACK SELECT] key 3 and REC READY indicator 3 in the level meter/counter will blink, indicating that track 3 is in record-ready mode.

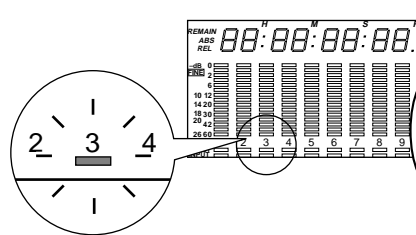

2. Make sure that [ON] key 8 is lit, and while producing sound on your instrument, watch level meter 3 in the level meters/counter section. Level meter 3 will show the level of the input signal of track 3. If the red 0 dB segment lights, lower fader 8 (input level of input channel 8).

Make monitor settings

We will make settings so that the signal of the rhythm machine (drums) that were earlier recorded on tracks 1/2 and the bass signal being recorded on track 3 will be sent to the stereo bus, and can be monitored via the MONITOR OUT jacks or PHONES jack.

1. Press the [PAN] key → [F3] key.

The PAN/ROUTE screen PAN Moni page will appear, allowing you to make pan and bus assignment settings for monitor channels 1–16.

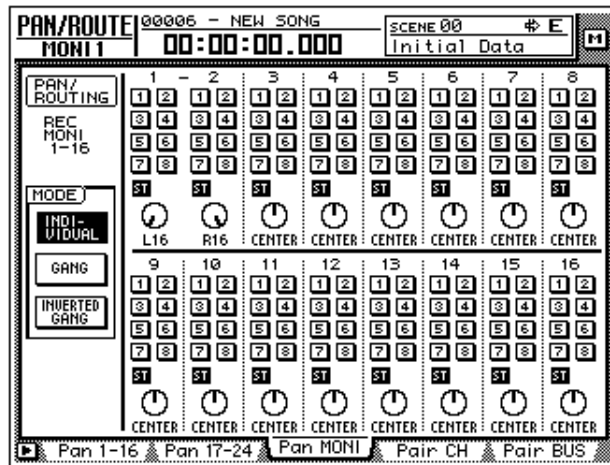

2. For monitor channel 3, turn the ST button on and the bus assign 1–8 buttons off.

At this time, verify that the ST button is on and the bus assign 1–8 button is off for monitor channels 1–2 as well.

3. Move the cursor to the PAN knob of monitor channel 3, and pan the bass where you can monitor it most comfortably.
4. Make sure that [ON] key 3 is turned on. Then produce sound on your bass, and raise fader 3 to a volume that is comfortable for monitoring.

Using EQ and the dynamics processor

By using the four-band EQ and dynamics processor that are provided for each input channel, you can process the bass sound as you record it on a track.

□ Using the four-band EQ

1. In the MIXING LAYER section, press the [1–16] key → [SEL] key 8. [SEL] key 8 will light, and input channel 8 will be selected for control.
2. Press one of the EQ [HIGH]/[HI-MID]/[LO-MID]/[LOW] keys in the row at the right of the display to select the band that you wish to control. When you press a key, the settings of that band will appear for a time in the upper right of the display.

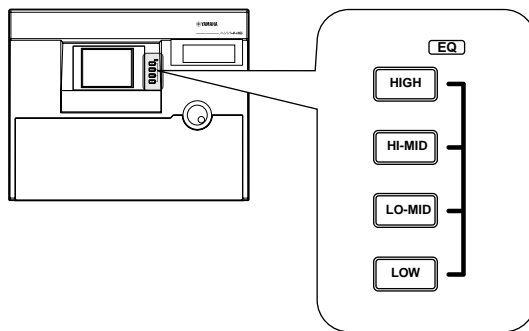

The keys/controls at the right of the display can be used as dedicated controls for the channel that is currently selected by the [SEL] key. As with EQ, you can also use the [PAN] control located at the right of the display to adjust the panning of the currently selected channel.

3. Use the EQ [Q]/[F]/[G] controls to adjust the band that you selected in step 2. The function of each control is described below.

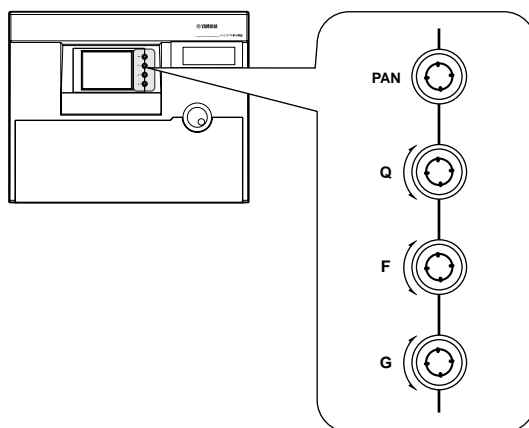

- [Q] Adjust the steepness of each band. The range is 10.0–0.10, and higher settings will produce a steeper EQ curve. The [Q] control of the HIGH band can also be used as a switch to change the EQ type between shelving and LPF. The [Q] control of the LOW band can also be used as a switch to change the EQ type between shelving and HPF.

- [F] Set the center frequency of each band. For each band, the range is 21 Hz–20.1 kHz.
- [G] Set the amount of boost/cut for each band. For each band, the range is ± 18 dB.

When you operate the EQ [Q]/[F]/[G] controls, the parameter values of that band will briefly appear in the upper right of the display.



.....
As an alternative way to make EQ settings, you can also use the EQ/ATT/GRP screen EQ/Att page ([EQ] key → [F1] key). The EQ/Att page displays all EQ parameters of the currently selected channel.



.....
If the sound does not change when you operate the EQ, check whether the EQ ON button is turned on in the EQ/ATT/GRP screen EQ/ATT page.

□ Using the dynamics processor

1. In the MIXING LAYER section, press the [1–16] key → [SEL] key 8. [SEL] key 8 will light, and input channel 8 will be selected for control.
2. Press the [DYN] key → [F2].
The DYN/DLY screen Library page will appear.

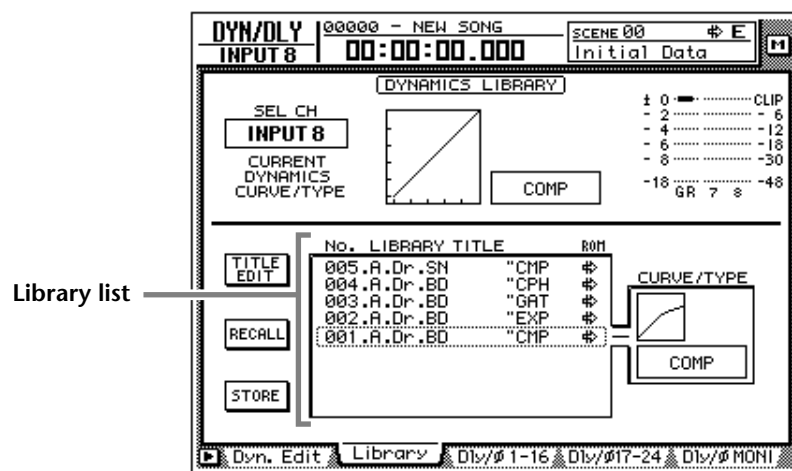

In this page you can load or save dynamics programs from or to the dynamics library. From the library list in the center of the screen, you can select the dynamics program that you wish to load or save.

3. Move the cursor to the library list, and rotate the [DATA/JOG] dial to move the cursor location to "011.E.B.Finger."
Dynamics library numbers 000–040 are read-only programs, and contains standard dynamics settings for frequently used instruments. For this example, we will select a program named "E.B. Finger."
4. Move the cursor to the RECALL button at the left of the library list, and press the [ENTER] key.

5. A CONFIRMATION popup window will appear, asking you confirm the recall operation.



6. Move the cursor to the OK button and press the [ENTER] key.
The “E.B.Finger” dynamics program will be loaded into input channel 8.
7. Press the [F1] key.
The DYN/DLY screen Dyn.Edit page will appear. In this page you can set the parameters of the dynamics processor.
8. Press the [ENTER] key, and turn on the ON/OFF button located in the lower left of the screen.
As the name suggests, the ON/OFF button turns the dynamics processor on/off.

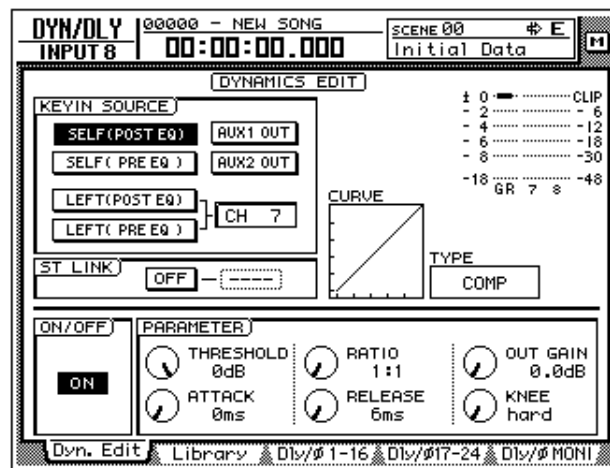

9. While playing the bass, move the cursor to the PARAMETER area in the lower right of the screen, and adjust the parameters of the dynamics processor.
 - Five types of dynamics processor are provided: CMP (compressor), EXP (expander), GAT (gate), CPS (compander S), and CPH (compander H). Each type has different parameters. (For details on the parameters of each type, see the Reference Guide.)
 - It is not possible to change the type of the dynamics processor in the Dyn.Edit page. For this reason if you wish to use a specific type, you must first load a program that uses that type from the dynamics library, and then modify its parameters as necessary.

Let's overdub!

1. Press the Locate section [RTZ] key.
2. To begin recording, hold down the Transport section [REC] (●) key and press the [PLAY] (▶) key.
The [REC] key and [PLAY] key will light, and the red REC READY indicator of track 3 will change from blinking to lit.
3. Play the bass while listening to the rhythm machine (drum) performance recorded on tracks 1/2.



Tip!

.....
If you wish to adjust the volume at which you are monitoring the rhythm machine (drums) and bass, press the MIXING LAYER section [MONI] key, and adjust faders 1–3.

4. When you are finished playing, press the [STOP] (■) key.
5. To listen to the recorded performance, press the Locate section [RTZ] key, and then press the Transport section [PLAY] (▶) key.
6. If you are satisfied with the recorded performance, press [REC TRACK SELECT] key 3 to defeat record-ready mode for track 3.
If you wish to continue overdubbing more instrumental tracks, simply use the same procedure. Go ahead and record the remaining instruments.



Tip!

.....
If you wish to try the recording again, press the [UNDO] key and repeat steps 1–4. It is also possible to re-record from the middle of the song. If you will be re-recording repeatedly from the same location, it is convenient to assign a marker (→ P.121) to that location so that you can move rapidly to it, or to use the auto punch-in/out function (→ P.130).

Mixdown

In this section we will explain the procedure for creating a stereo mix of the signals recorded on tracks 1–16, applying internal effects, and recording the stereo track on the hard disk.

Creating the mix balance of the tracks

1. Make sure that [REC TRACK SELECT] keys 1–16 are dark (record-ready mode is defeated). Also make sure that the [ON] key is dark for all input channels 1–24.



.....
 If necessary, the input signals from input channels 1–24 can be mixed down together with the signals of tracks 1–16. In this case, turn on the [ON] keys of the input channels that you wish to use, so that they are lit.

2. Press the [MONI] key.
 Monitor channels 1–16 will be selected as the mixing layer.
3. Press the [PAN] key → [F3] key.
 The PAN/ROUTE screen Pan MONI page will appear, allowing you to make pan settings and bus assignments for monitor channels 1–16.

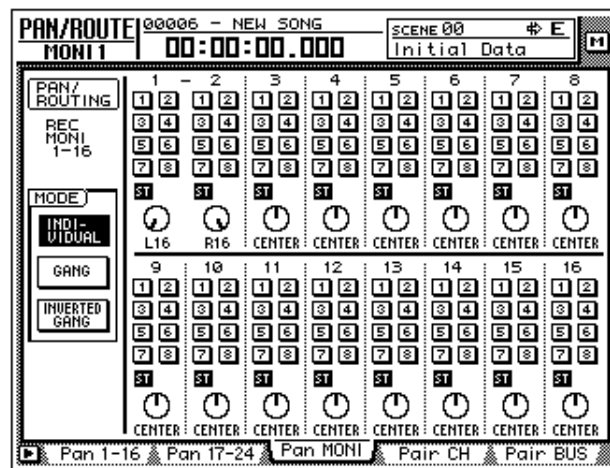

4. For monitor channels 1–16, turn the ST button on and the bus assign 1–8 buttons off.
 With these settings, all monitor channels will be sent to the stereo bus.
5. Use the PAN knobs of monitor channels 1–16 to set the stereo position of each track.



.....
 You can also use the [SEL] keys to select a channel and use the [PAN] control at the right of the display to set the pan of the corresponding monitor channel.

6. Raise the STEREO fader to the 0 dB position.
7. Make sure that [ON] keys 1–16 and the STEREO [ON] key are lit, play back the song from the beginning, and use faders 1–16 to set the level of each track.
At this time, watch the L/R level meter of the level meter/counter, and do not allow the red 0 dB segment to light.
8. To adjust the EQ of a specific channel, use the [SEL] key to select the channel and operate the EQ [HIGH]/[HI-MID]/[LO-MID]/[LOW] keys and the EQ [Q]/[F]/[G] controls.
9. To use the dynamics processor of a specific channel, use the [SEL] key to select the channel and press [DYN] key → [F2] key to load the desired dynamics program.
For the procedure of loading a dynamics program, refer to page 92. To edit the dynamics processor parameters, press the MIXER section [DYN] key → [F1] key to access the DYN/DLY screen Dyn.Edit page.

Using the Solo function

The AW4416 provides a flexible Solo function. By pressing the top panel [SOLO] during recording or playback and using one of the [ON] keys to select a desired channel, you can monitor only the corresponding channel. Here we will explain how you can use the Solo function to monitor only the desired track during mix-down.

1. Press the [SETUP] key → [F3] key.
The SET UP screen Solo Setup page will appear. In this page you can make various settings for the Solo function.

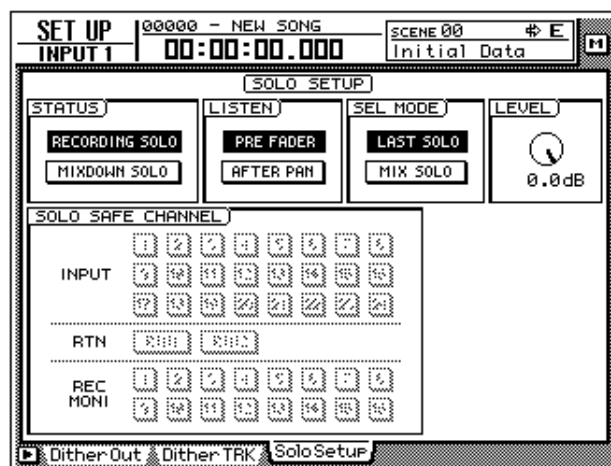

If the Solo Setup tab is not assigned to the [F3] key, press the [SHIFT] key + [F1] key to switch the tab, and then press the [F3] key.

**Tip!**

As an alternative to using the Solo function, you can also monitor just a specific track by pressing the TRACK [CUE] switch in the level meters/counter section, and then using [REC TRACK SELECT] keys 1–16 to select a track. By using this method, the direct output of the recorder (the signal that has not passed through the monitor channel) can be sent directly to the MONITOR OUT jacks and the PHONES jack.

2. Move the cursor to the SOLO STATUS area, and select one of the following two modes for the Solo function.

RECORDING SOLO

In this mode, the solo signal is routed through the dedicated SOLO bus and output from the MONITOR OUT jacks and PHONES jack. The stereo bus and buses 1–8 will not be affected. You can monitor even channels that are not assigned to the stereo bus or to buses 1–8, or channels whose [ON] key is turned off.

**Tip!**

If you will be using the Solo function during multitrack recording, it is convenient to select RECORDING SOLO so that specific channels can be monitored without affecting the stereo bus or buses 1–8.

MIXDOWN SOLO

In this mode, the solo signal is routed through the stereo bus and output from the MONITOR OUT jacks and PHONES jack. When the Solo function is turned on, only the soloed channels will be sent to the stereo bus, and the remaining channels will be muted. It will not be possible to monitor channels whose [ON] key is turned off, nor channels that are not assigned to the stereo bus.

**!**

If MIXDOWN SOLO mode is selected, the Solo Setup page LISTEN settings and LEVEL settings will be ignored (they will be grayed out).

In this example, we will use MIXDOWN SOLO mode. Move the cursor to the MIXDOWN SOLO button, and press the [ENTER] key.

3. Move the cursor to the SEL MODE area, and choose one of the following ways in which the channel(s) to be monitored in Solo mode will be selected.

LAST SOLO

When the [SOLO] key is on, only the channel whose [ON] key was pressed last will be monitored.

MIX SOLO

When the [SOLO] key is on, all channels selected by their [ON] key will be monitored.

Move the cursor to one of these buttons, and press the [ENTER] key.

4. Move the cursor to the SOLO SAFE CHANNEL section, and select the channel(s) that you wish to set to Solo Safe mode.

Solo Safe is a function that excludes specified channels from the Solo function when MIXDOWN SOLO mode is selected. Move the cursor to the button(s) for the channel(s) that you wish to set to Solo Safe, and press the [ENTER] key. (You may select more than one channel.)



For example if the SOLO SAFE CHANNEL section RTN1/RTN2 buttons are on, the Solo function will not affect return channels 1/2. This allows you to monitor the soloed channel with an effect such as reverb still applied.

- To use the Solo function, play back the recorder and press the [SOLO] key.

The [SOLO] key and [ON] keys 1–16 will blink.

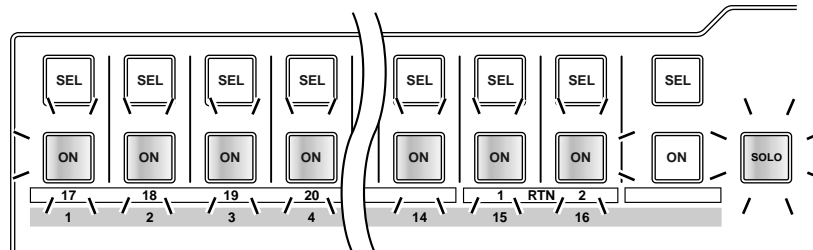

- Press the MIXING LAYER section [MONI] key, and press the [ON] key for the monitor channel corresponding to the track you wish to monitor. If you selected LAST SOLO in step 3, only the channel whose [ON] key was last pressed will be monitored. If you selected MIX SOLO, all channels selected by their [ON] key will be monitored.

At this time, all [ON] keys 1–16 other than the selected key(s) will go dark.

- To defeat the Solo function, press the [SOLO] key once again.



Solo operations using the [ON] keys are also linked for paired channels.

Using the internal effects

The AW4416 provides two internal effects, which can be used either via AUX send/return or by being inserted into a specific channel. Here we will explain how to use the AUX bus to apply reverb to the signals of the tracks.

1. Press the [AUX 7] key → [F2] key.

The AUX7/EFF1 screen Library page will appear. In this page you can load or save effect programs from or to the effect library. The list in the display shows the effect programs that have been saved.

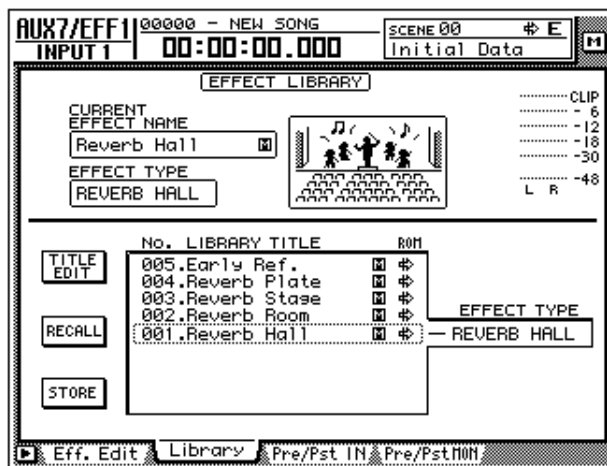

Tip!

When the AW4416 is in the initial state, the outputs of AUX buses 7/8 are patched to the inputs of internal effects 1/2, and the outputs of internal effects 1/2 are patched to return channels 1/2.

2. Move the cursor to the library list, and rotate the [DATA/]OG] dial to display “002.Reverb Room” at the cursor location.

In this example we will select a reverb room program.



Tip!

If desired, you can recall the effect program directly without having to reply to the recall confirmation popup window. To make this setting, access the UTILITY screen Prefer.1 page ([UTILITY] key → [F2] key), and turn RECALL CONFIRMATION off.

3. Move the cursor to the RECALL button and press the [ENTER] key.

A CONFIRMATION popup window will appear, asking you to confirm the recall operation.



4. Move the cursor to the OK button and press the [ENTER] key.

The “Reverb Room” effect program will be loaded into internal effect 1.

5. Press [PAN] key → [F2] key.

The PAN/ROUTE screen Pan 17–24 page will appear, allowing you to make pan settings and bus assignments for input channels 17–24 and return channels 1/2.

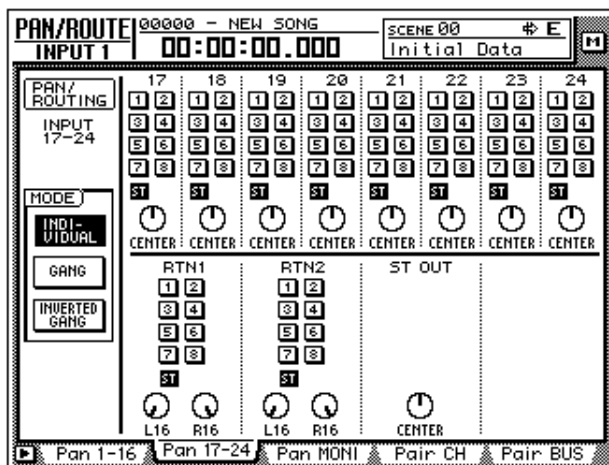

6. Make sure that the RTN1 (return channel 1) area ST button is on, and that the two PAN knobs are turned to the far left and right.

With these settings, the return signal from effect 1 will be sent to the stereo bus and mixed with the signals of the monitor channels.

7. Press the [MONO] key → [AUX 7] key.

Monitor channels 1–16 will be selected as the mixing layer. In this state, faders 1–16 will adjust the send level of the signals sent from monitor channels 1–16 to AUX 7 (effect 1).

8. Play back the song from the beginning, and use faders 1–16 to adjust the send level of each monitor channel.
9. If necessary, press the [HOME] key → [17–24 RTN] key and use fader 15 to readjust the effect return level.



Tip!

.....
When the AW4416 is in the initial state, the faders of return channels 1/2 are set to nominal level (0 dB).

Other convenient functions

The mixer section of the AW4416 provides other convenient functions as described below. You can use them as needed.

□ Fader groups

This function groups fader operations for multiple channels. By moving a single fader, you can adjust all faders in that group while preserving the current balance. To set or cancel fader groups, use the EQ/ATT/GRP screen FaderGrp page ([EQ] key → [F3] key). (Refer to Reference Guide “EQ/ATT/GRP screen/FaderGrp page.”)

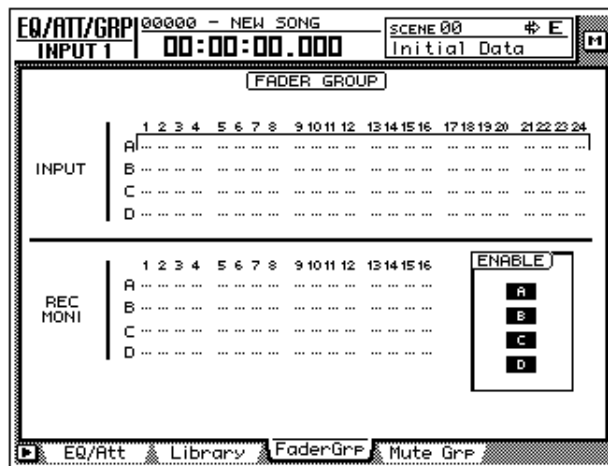

Faders in the same group must not be moved manually at the same time. Doing so will strain the motors and cause malfunctions.

□ Mute groups

This function groups [ON] key operations for multiple channels. (On and off statuses can be mixed.) By operating a single [ON] key, you can switch the on/off status of each channel in the group. To set or cancel mute groups, use the EQ/ATT/GRP screen MuteGrp page ([EQ] key → [F4] key). (Refer to Reference Guide “EQ/ATT/GRP screen/MuteGrp page.”)

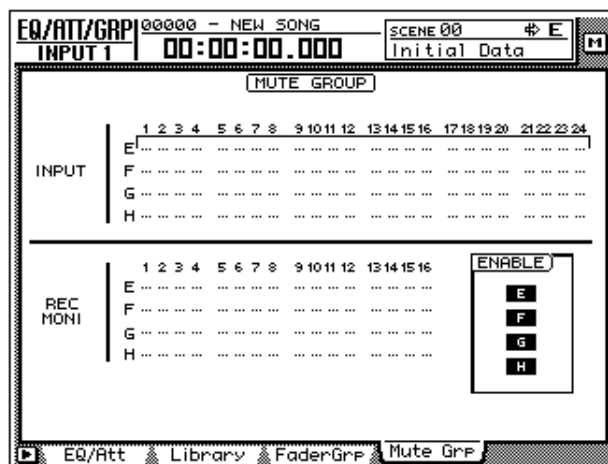

□ Automix

By using this function, fader and [ON] key operations, changes in mix parameters such as EQ and pan, and events such as scene memory or library selection can be recorded and played back in realtime in synchronization with the song. You can also record operations in multiple stages, or edit recorded events later. To record or play back scene memories, you can use the AUTOMIX screen Main page ([AUTOMIX] key → [F1] key), etc.

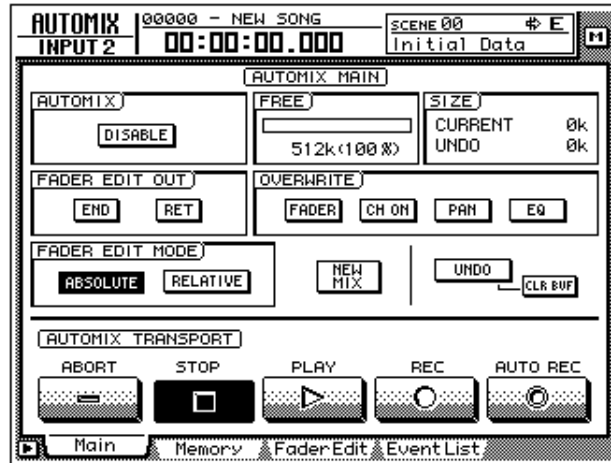

Recording the stereo track

The recorder section of the AW4416 provides a stereo track that is independent of audio tracks 1–16, and which is used mainly as a master track for creating a two-track mix.

Here we will explain the procedure of mixing the signals of tracks 1–16 and the return signals from the internal effects into a stereo track to create a finished song.

1. Press the REC TRACK SELECT [ST] key.
The stereo track will be in record-ready mode.

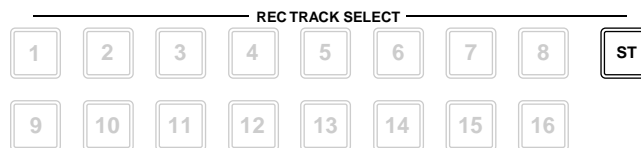

The input of the stereo track is internally connected to the stereo output channel of the mixer. This means that the L/R level meter in the level meters/counter section can be used as the input level meter for the stereo track.

- Play back the song from the beginning, and watch the L/R level meter in the level meters/counter section.
If the red 0 dB segment lights, lower faders 1–16 and/or the STEREO fader.

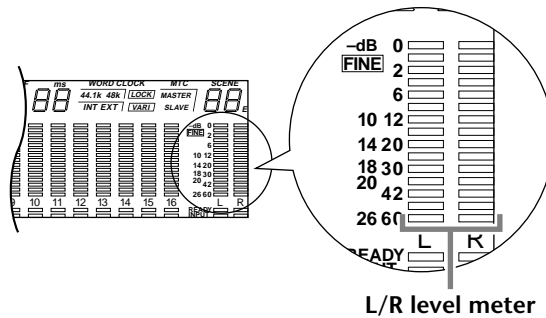

- After you have set the level, rewind the song to the beginning. Then hold down the Transport section [REC] (●) key and press the [PLAY] key (▶).
Recording on the stereo track will begin.



In order to create an audio CD (44.1 kHz), there must be at least four seconds of data in the stereo track.

- When you are finished recording, press the [STOP] (■) key.
- To listen to the newly recorded stereo track, press the Recorder section [TRACK] key → [F3] key.
The TRACK screen Stereo page will appear, allowing you to play back or erase the stereo track. When the AW4416 is in the initial state, the M (mute) button in the upper left of the screen will be turned on, muting the stereo track.

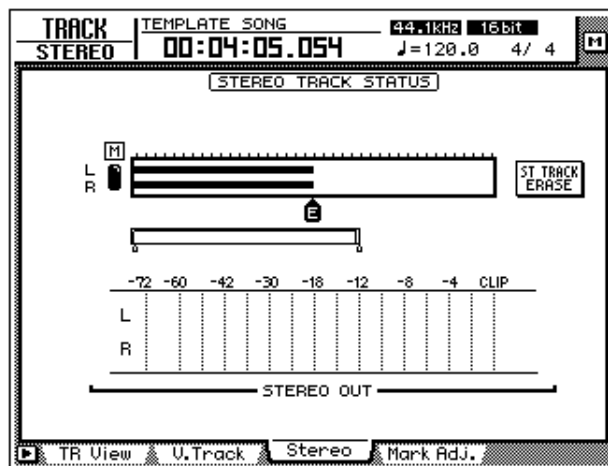

- Move the cursor to the M (mute) button and press the [ENTER] key.
Muting of the stereo track will be defeated, allowing the stereo track to play back. At this time, the stereo track will automatically be assigned to monitor channels 1/2, and the remaining monitor channels will be muted. If you play back the song in this state, the stereo track can be monitored via monitor channels 1/2 → stereo bus.

However with this monitoring method, the signal will pass through the monitor channel and the output channel, meaning that you will not necessarily be monitoring in a “flat” state. Here’s how you can output the stereo track directly from the MONITOR OUT jacks.

- In the level meters/counter section, turn the TRACK [CUE] key on.

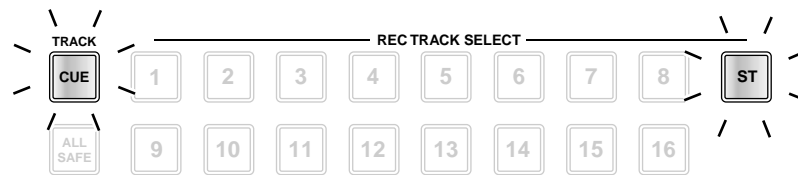

The TRACK [CUE] key is used to output the signal of the desired track directly to the MONITOR OUT jacks. If you press the TRACK [CUE] key when the stereo track is not muted, the TRACK [CUE] key will blink and the REC TRACK SELECT [ST] key will blink red. This indicates that only the stereo track can be selected as the signal for monitoring.

- Press the REC TRACK SELECT [ST] key.

The TRACK [CUE] key and REC TRACK SELECT [ST] key will change from blinking to lit. This indicates that the stereo track is selected as the signal for monitoring.



.....
When you use the TRACK [CUE] key, the signal will be output directly to the MONITOR OUT jacks, and therefore the fader cannot be used to adjust the level. To avoid sudden loud sounds, lower the MONITOR OUT control beforehand.

- Press the Locate section [RTZ] key, and then press the Transport section [PLAY] (▶) key.

The signal of the stereo track will be sent in monaural directly to the MONITOR OUT jacks.

- If you are satisfied with the recorded result, turn off the TRACK [CUE] key.

The REC TRACK SELECT [ST] key will go dark simultaneously. To defeat muting for audio tracks 1–16, access the TRACK screen Stereo page and turn the M (mute) button on once again.



.....
Only one stereo track can be used for each song. If you wish to try the mixdown again, perform the Undo operation. If Undo is not possible, access the TRACK screen Stereo page, move the cursor to the ST TRACK ERASE button in the right side of the screen, and press the [ENTER] key to erase the stereo track. Then record it once again.

Saving a scene/song

□ Saving a scene

If you wish to reproduce the mixer settings as well when you recall the current song at a later time, you must store the current mix parameters as a Scene.

1. Use the [▼]/[▲] keys in the SCENE MEMORY section of the top panel to select the store destination scene number (01–96).
The currently selected scene number will appear in the upper right of the level meter/counter.

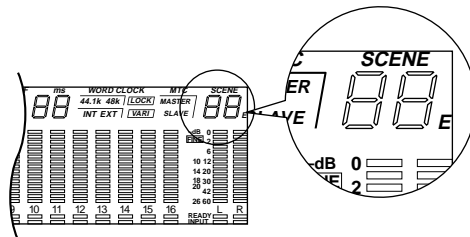
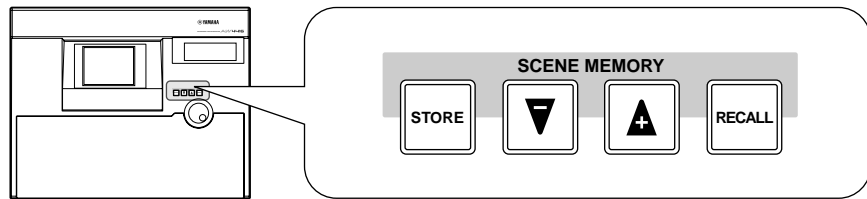

Scene number 00 contains a preset recall-only scene that returns all mix parameters to their default state. For this reason, it is not possible to store a scene into number 00.

2. Press the SCENE MEMORY section [STORE] key.
The TITLE EDIT popup window will appear, allowing you to assign a name to the scene memory.

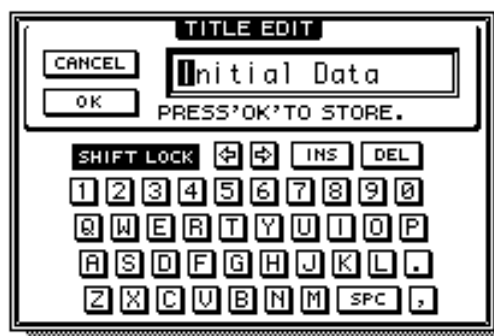

If STORE CONFIRMATION is turned "OFF" in the UTILITY screen Prefer.1 page ([UTILITY] key → [F2] key), the scene will be stored directly to the specified scene number without displaying this confirmation popup window. This is more convenient if you will be repeatedly overwriting a scene onto the same scene number.

- As desired, assign a scene name of up to 16 characters. (For details on inputting characters, refer to page 60.) When you are finished, move the cursor to the OK button and press the [ENTER] key.

The scene will be stored.

□ Saving a song

The current song will be saved automatically when you create a new song, load an existing song, or perform the shut-down procedure. However as a precaution against the power being accidentally turned off while you are working, it is a good idea to save your song frequently, and not just after completing the mix-down.



- When you save a song, the scene memory contents and only the scene number (i.e., not the settings) of the most recently stored/recalled scene will be saved together with the song. Be aware that the current mix parameters are not saved.
- When an existing song is loaded, the scene number that was most recently stored/recalled for that song will be displayed in the upper right of the level meter/counter. If you wish to reproduce both the song and the mix parameters, you must press the SCENE MEMORY section [RECALL] key and recall that scene immediately after loading the song.

- Press the WORK NAVIGATE section [SONG] key → [F1] key.

The SONG screen Song List page will appear.

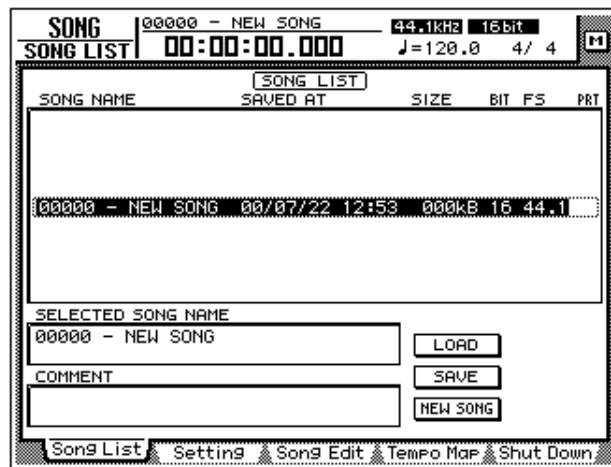

The data for the current song (date, size, quantization bits, sampling frequency, protect) shown here in the song list is the data for when the song was last saved. When you perform the following Save procedure and press the [ENTER] key, it will be overwritten by the new data.

- Move the cursor to the SAVE button at the bottom of the screen, and press the [ENTER] key.

A CONFIRMATION popup window will appear, asking you to confirm the Save operation.



.....

When you shut down the AW4416, the current song will be saved automatically. However, we recommend that you save the song manually when you are finished recording (→ P.177). If you fail to do this, the song will revert to the last-saved state if the power of the AW4416 is turned off accidentally.







3. Move the cursor to the OK button and press the [ENTER] key.
The song will be saved.

6 Transport/locate operations

This chapter explains transport and locate operations on the AW4416.

Table of transport key operations

The function of the keys in the transport section of the AW4416 will change depending on the status (current operating mode) of the transport. The following table shows how the transport keys change function according to the status of the transport.

Status/ Transport keys	Stopped	Playing	Rewinding	Fast- forwarding	Recording	A-B repeating
STOP 	—	Stop	Stop	Stop	Stop	Stop
PLAY 	Play	—	Play	Play	Play (punch-out)	—
REW 	Rewind (8X)	Rewind (8X)	Switch rewind speeds (8X↔16X)	Rewind (8X)	—	Defeat repeat, and rewind (8X)
FF 	Fast-for- ward (8X)	Fast-for- ward (8X)	Fast-forward (8X)	Switch fast- forward speeds (8X↔16X)	—	Defeat repeat, and fast-forward (8X)
REC + PLAY  + 	Record*	Record* (punch-in)	Play	Play	—	—

* : Recording will occur only if any of the [REC TRACK SELECT] keys are blinking.

— : Key has no function.

Shuttle function (cue/review operation)

While the transport is stopped or playing, you can operate the [SHUTTLE] dial to play forward (cue) or play backward (review) at various speeds.

The cue or review speed will change according to the angle of the [SHUTTLE] dial, as shown in the following diagram. When the [SHUTTLE] dial is returned to the center, the shuttle function is defeated, and the transport will return to the state in which it was before you operated the dial (i.e., stopped or playing).

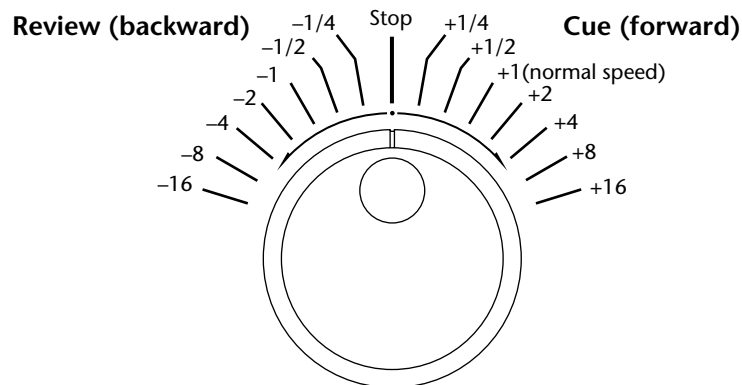

Nudge function

“Nudge” is a function that repeatedly plays back a short region before and after the current location, and lets you move the current location forward or backward in small steps so that you can search for a desired point. This lets you accurately specify a point in the song, such as when setting the auto punch-in/out points, or setting the range for a track editing operation.

□ Using the Nudge function

1. Use normal transport operations or the shuttle function to locate to the general area of the desired point in the song.
2. Press [JOG ON].
The [JOG ON] key will light, and playback will repeat over a fixed region (the default setting is 100 milliseconds) starting at the current location.



.....
The result may sound different depending on the number of tracks that are being played back simultaneously.

- To move the current location forward, turn the [DATA/JOG] dial toward the right. To move the current location backward, turn the [DATA/JOG] dial toward the left.

If time display (SECOND) is selected as the counter display mode, the current location will move in millisecond steps. If time code display (TIME CODE) is selected as the counter display mode, the current location will move in sub-frame steps.

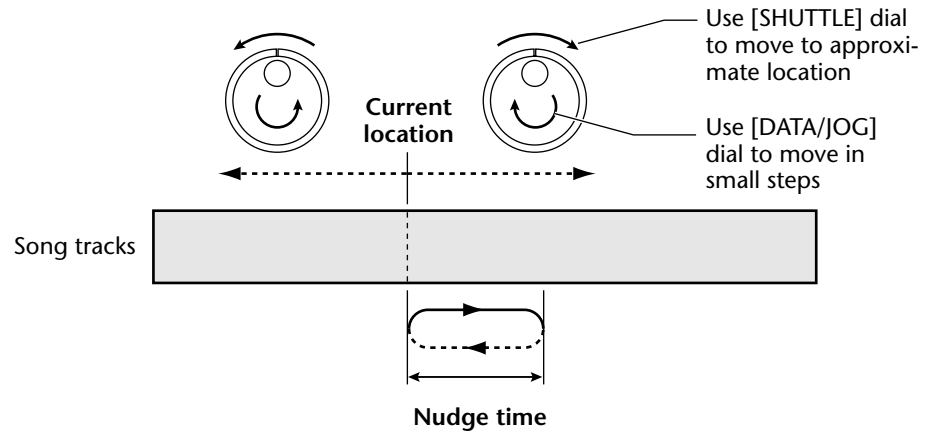

.....
 If you use the Nudge function when the counter display is set to MEASURE, turning the [DATA/JOG] dial will move only in steps of one beat, meaning that you will not be able to set the location precisely. Before using the Nudge function, you should switch the counter display to either the Time display or the Time Code display (Refer to Reference Guide “SONG screen/Setting page”).



.....
 Normally, turning the Nudge function on will repeatedly play a 100 msec region starting at the current location. However, you can change the play mode of the Nudge function so that the repeated region ends at the current location, or adjust the length (“nudge time”) of the repeated region. For details on play mode and nudge time settings, refer to the section below, “Nudge function settings.”

- To defeat the Nudge function, press the [JOG ON] key or the [STOP] key of the transport section.

□ Nudge function settings

Here's how to adjust the nudge time and play mode of the Nudge function.

1. With the song stopped, press the [UTILITY] key → [F3] key.

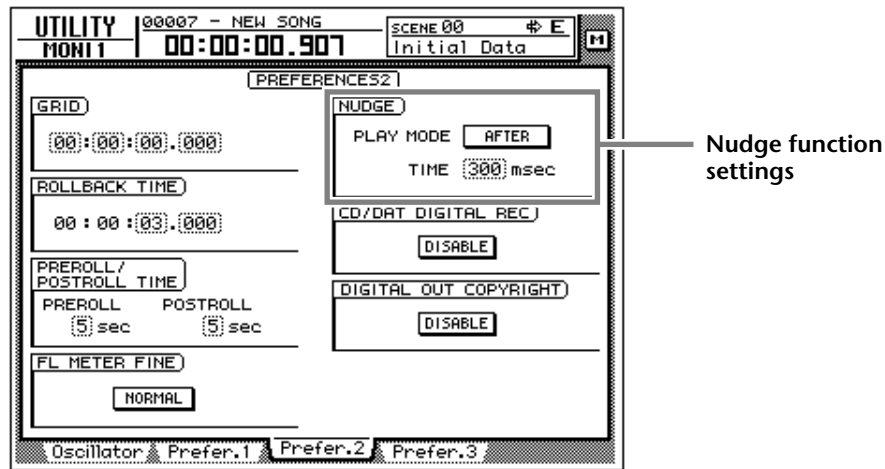

2. To set the nudge time, move the cursor to the TIME field of the NUDGE area, and rotate the [DATA/JOG] dial to set the nudge time (25–800 msec).
3. To change the play mode of the nudge function, move the cursor to the PLAY MODE field of the NUDGE area, and press the [ENTER] key to switch between the following two play modes.
 - **AFTER**.....Repeatedly play back a range starting at the current location and extending the length of the nudge time setting.
 - **BEFORE**.....Repeatedly play back a range corresponding to the length of the nudge time setting and ending at the current location.

PLAY MODE= BEFORE

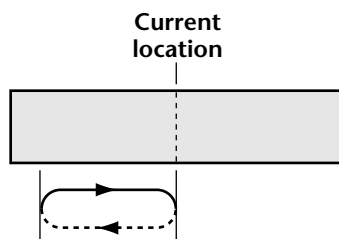

PLAY MODE= AFTER

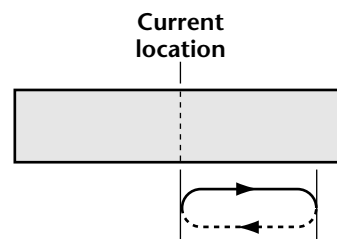

Rollback function

While the song is stopped or playing, you can press the [ROLL BACK] key of the Locate section to move the current location back by a fixed length. This is convenient when you are playing back, and come to a location that you wish to listen to once again. The rollback time is set to 5 seconds by default, but can be adjusted as desired.

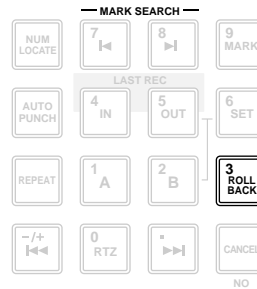

1. With the song stopped, press the [UTILITY] key → [F3] key.

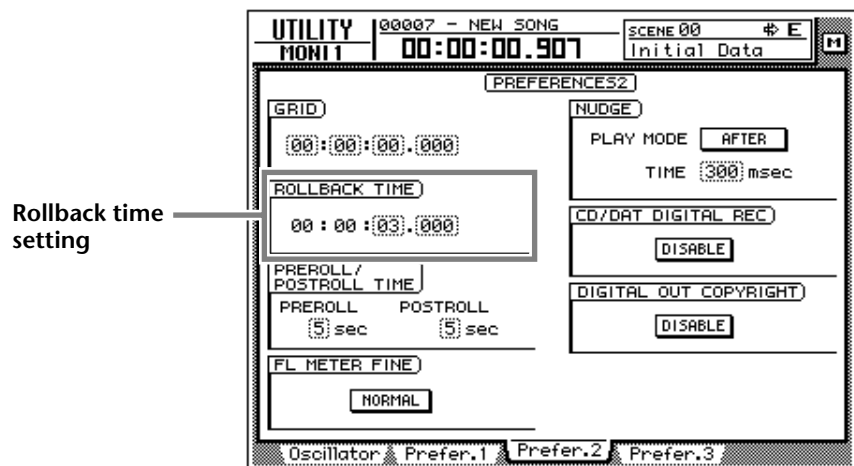

2. Move the cursor to the ROLLBACK TIME field, and use the [DATA/JOG] dial to set the rollback time.
The rollback time can be adjusted in millisecond steps over a range of 0–5 seconds (default setting is 5 seconds).
3. When the song is stopped or playing, press the [ROLL BACK] key.
If the [ROLL BACK] key is pressed while stopped, the current location will simply move back by the length of the rollback time. If pressed while playing, playback will resume immediately after the rollback occurs.

Locating to a specific point

You can directly specify a locate point as a numerical value, and locate to it. Here's how.

1. With the transport stopped, press the [NUM LOCATE] key of the Locate section.

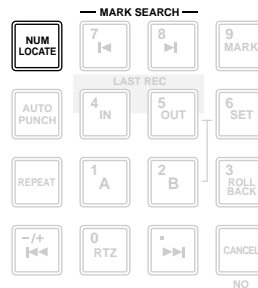

If you have selected a screen where normal transport operations cannot be performed, such as the SONG screen or the MASTERING screen, the [NUM LOCATE] key cannot be used even if the cursor is displayed at the counter in the upper part of the display.

The cursor will move to the counter in the upper part of the display.

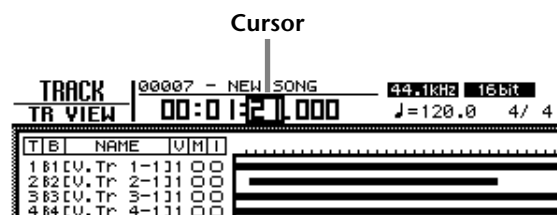

2. To specify the locate point using the [DATA/JOG] dial, use the CURSOR [◀]/[▶] keys to move the cursor to the digit that you wish to change, and rotate the [DATA/JOG] dial to specify the value.
3. To specify the locate point using the numeric keys (keys 0–9 of the locate section), move the cursor to the lowest digit of the value you wish to input, and use the numeric keys to directly input the value.
If the time display (SECOND) is selected as the counter display type, you can specify the value as hours/minutes/seconds/milliseconds; if time code display (TIME CODE) is selected, you can specify hours/minutes/seconds/frames/sub-frames; if measure display (MEASURE) is selected, you can specify measures/beats.
4. To execute the Locate operation, press the [ENTER] key.

Locating to the zero location of the counter

When the song is stopped or playing, you can press the [RTZ] key of the Locate section to locate to the zero location of the currently displayed counter. (If the counter is displaying measures, you will locate to the beginning of the first measure.)

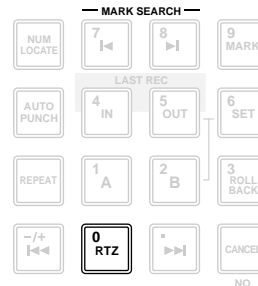

If the counter display type is set to Time (SECOND) or Time Code (TIME CODE), the point to which the [RTZ] key will locate will depend on whether absolute time or relative time is being displayed.

○ If the counter shows absolute time (ABS)

Pressing the [RTZ] key will locate to the 00:00:00.00 position if the counter shows the time code, or to the start point (zero absolute time) if the counter shows the time.

○ If the counter shows relative time (REL)

Pressing the [RTZ] key will locate to the point that the user specified as zero relative time. (For details on setting the zero relative time, refer to the section below.)



.....
If Measure display (MEASURE) is selected for the counter, you cannot switch between absolute time and relative time; pressing the [RTZ] key will always locate to the start point of the song.

□ Setting the zero relative time location

You can use the following procedure to set the relative (REL) zero point that is displayed by the counter.

1. Locate the song to the point that you wish to set as relative zero.
2. Hold down the Locate section [SET] key, and press the [RTZ] key.
 If the counter had been displaying the relative time (REL), the counter display will be reset to zero (00:00:00.000). If the counter had been displaying the absolute time (ABS), it will automatically switch to relative time, and will be reset to zero (00:00:00.000).

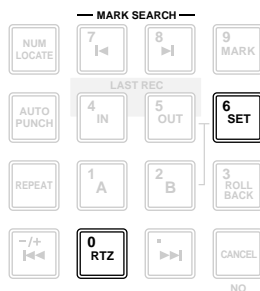

3. If you wish to return the counter to the absolute time display, press the [ABS/REL] key.

The specified relative zero location will be displayed as follows in the TRACK screen → TR View page that appears when you press the [TRACK] key → [F1] key.



Tip!
 The zero relative time location is saved on the hard disk as part of the currently selected song.

Locating to the start/end points

The start point and end point normally correspond to the beginning and end of the song. When you create a new song, absolute time 00:00:00.000 will be set as the default start point. When you record a song, the last point in the song will automatically be set as the end point. (If you extend the length of the song, the end point will move accordingly.) You can locate to the start point by pressing the [◀◀] key of the Locate section, or to the end point by pressing the [▶▶] key.

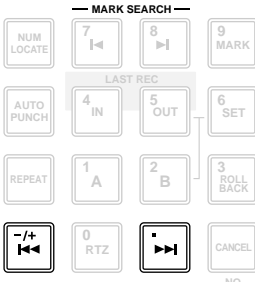

The start point and end point will be displayed as follows in the TRACK screen TR View page that appears when you press the [TRACK] key → [F1] key.

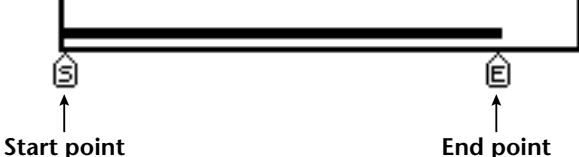

Tip!
The locations of the start point and end point can be adjusted as desired (→ P.123).

A-B repeat

A-B Repeat is a function that repeatedly plays back the region between the point A and point B that you specify. The A/B points can be set when the song is either stopped or playing.

□ Setting the A/B points

1. Locate the song to the location where you wish to set point A (the beginning of the repeated playback).
2. Hold down the Locate section [SET] key and press the [A] key.

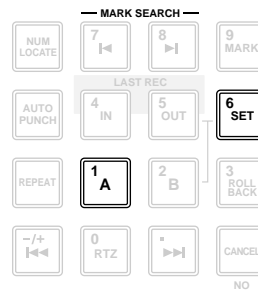

The [A] key will light, indicating that point A has been set.

3. Locate the song to the location where you wish to set point B (the end of the repeated playback).
4. Hold down the [SET] key and press the [B] key.

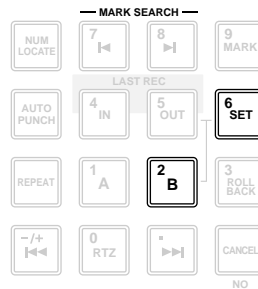

The [B] key will light, indicating that point B has been set.



Tip!

.....
You can also use the [A]/[B] keys to locate directly to points A/B.

□ Performing A-B repeat playback

5. To perform repeat playback, press the Locate section [REPEAT] key when the transport is stopped. The transport will automatically locate to point A.



Tip!

.....
If you press the [REPEAT] key during playback, repeated playback between points A/B will begin automatically. If you press the [REPEAT] key during repeat playback, you will return to normal playback.

6. Press the [PLAY] key. Repeated playback between points A/B will begin.

7. To defeat A-B repeat, press the [REPEAT] key.

The [REPEAT] key will go dark, indicating that A-B repeat has been defeated. If you pressed the [REPEAT] key to defeat A-B repeat, normal playback will resume from that point.

The A/B points that you specify will be displayed as follows in the TRACK screen TR View page that appears when you press the [TRACK] key → [F1] key.

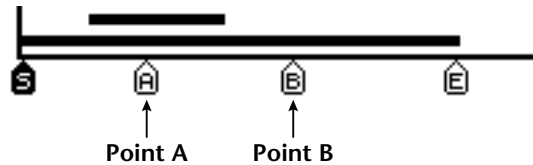

.....
The A and B points must be at least one second apart.



Tip!

- If you set point B earlier than point A and press the [REPEAT] key, playback will repeat from B → A.
- The A/B points you set can be deleted (→ P.126) or moved (→ P.123) as desired.
- The A/B point settings are saved on the hard disk as part of the currently selected song.

In/out points

The AW4416 remembers the locations at which recording was last begun and ended as the In point and the Out point. When the In and Out points are memorized, the [IN] and [OUT] keys will light. In this state, you can press the [IN] key or the [OUT] key to locate to the In or Out points. You can also set the In or Out points manually.

□ Setting the In point/Out point

1. Locate the song to the location where you wish to set the In point.
2. Hold down the Locate section [SET] key and press the [IN] key.

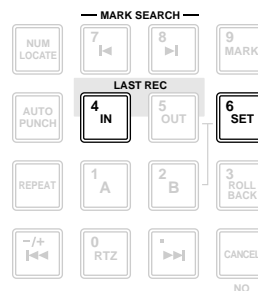

3. Locate the song to the location where you wish to set the Out point.
4. Hold down the [SET] key and press the [OUT] key.

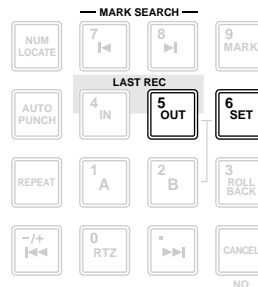

The In point and Out point that you specify will be displayed as follows in the TRACK screen TR View page that appears when you press the [TRACK] key → [F1] key.

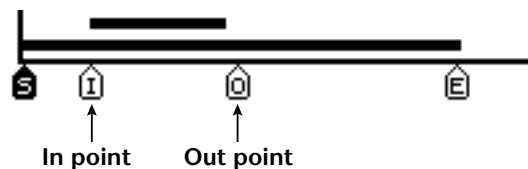

- The In/Out points are also used as the auto punch-in/out points used by auto punch-in/out (→ P.130).
- The In/Out point settings are saved on the hard disk as part of the currently selected song.



You must set the In point ahead of the Out point.

Markers

The AW4416 allows you to set up to 99 markers at any desired locations in the song. You can use the [◀]/[▶] keys to search/locate these markers. Markers are convenient when you wish to locate repeatedly to specific points in the song.

□ Setting a marker

1. Locate the song to the point where you wish to set a marker.
2. Press the Locate section [MARK] key.

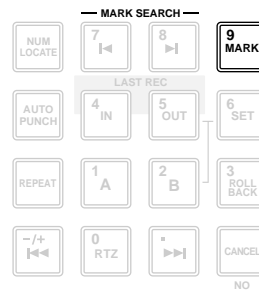

Marker settings can be made when the song is either playing or stopped. When you press the [MARK] key, a message of “MARK SET” will be displayed briefly at the bottom of the display, indicating that marker has been inserted at that point. Each time you press the [MARK] key, a new marker will be inserted.



.....
Marker settings cannot be made while recording.

□ Locating to a marker

3. To locate to the marker immediately before the current location, press the Locate section [◀] key. To locate to the marker immediately following the current location, press the [▶] key.

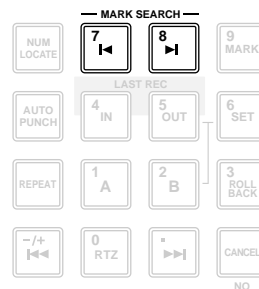

The [◀] key will light if a marker exists before the current location, and the [▶] key will light if a marker exists after the current location.

A number in the range of 1–99 will be assigned to each marker you set, and these will be displayed as follows in the TRACK screen TR View page that appears when you press the [TRACK] key → [F1] key.

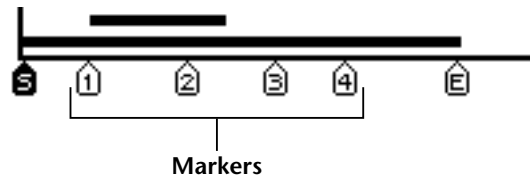

.....
Please note that the numbers 1–99 do not indicate the order in which you specified the markers; they indicate the order from the beginning of the song. For example if you insert a new marker between two existing markers, the subsequent markers will be renumbered.



-
- Marker settings are saved on the hard disk as part of the currently selected song.
 - The markers you set can be deleted (→ P.125) or moved (→ P.123) as desired.

Adjusting the location of a locate point

The location of the Start/End points, A/B points, In/Out points, and Markers can be adjusted as desired.

1. Press the [TRACK] key → [F4] key.
A screen will appear in which you can adjust the various locate points.

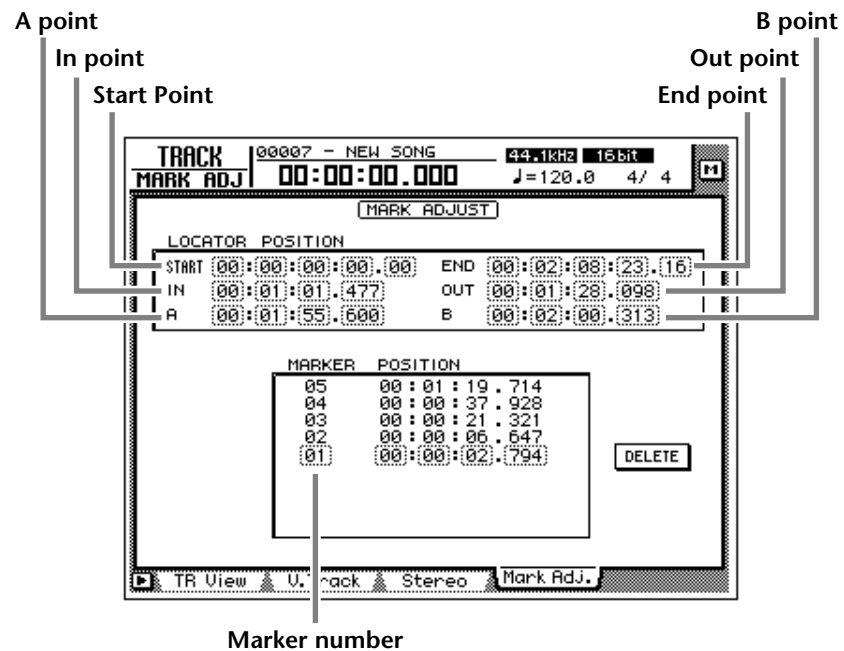

- Except for the Start/End points, the displayed location of the locate points will differ depending on the currently selected counter display type (Time, Time Code, Measure). The Start point and End point are always displayed as time code, regardless of the currently selected display method.
- The automix of the AW4416 operates according to the absolute time of the song. Be aware that if you change the start point after recording events in the automix, the song will no longer be synchronized with the automix.

2. Use the CURSOR [◀]/[▶]/[▲]/[▼] keys to move the cursor, and use the [DATA/JOG] dial to adjust the location of each locate point.

When you change the Start point, the absolute time zero of the song will change. For example if you change the Start point to "00:00:05:00.00," the location five seconds after the beginning of the song will be specified as absolute time zero. (If you press the [RTZ] key when absolute time is displayed, you will move to this point.)



- The smallest unit of adjustment will be a "millisecond" if time (SECOND) is selected as the counter display method, "sub-frame" if time code display (TIME CODE) is selected, or "beats" if measure display (MEASURE) is selected.
- When adjusting the location of a marker, it is not possible to move the marker beyond the preceding or following marker.

Start point= 00:00:00.00



Start point = 00:00:05:00.00

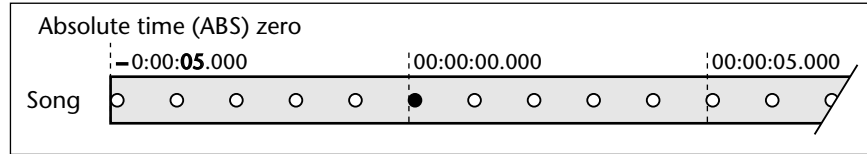

However, please be aware that changing the Start point will not affect the time code display of the counter. If you want the time code display to match the absolute time display, set the time code top to the Start point (Refer to Reference Guide "SONG screen/Setting page.").

Start point = 00:00:05:00.00

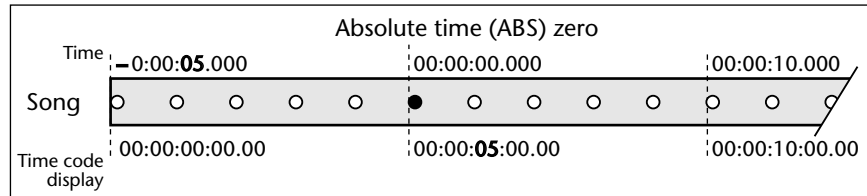

Deleting a locate point

A locate point (except for the Start/End points) can be deleted as follows.



Be aware that a locate point you delete cannot be recovered.

1. Press the [TRACK] key → [F4] key.

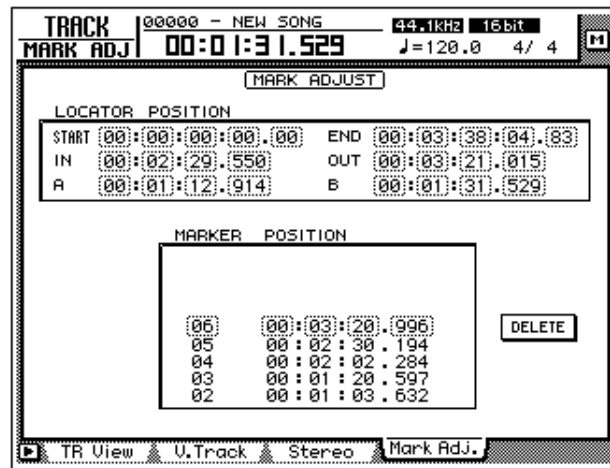

2. Move the cursor to the display area of the locate point you wish to delete, and press the [ENTER] key.

The selected locate point will be deleted. When you delete the In/Out point or the A/B point, the corresponding key ([IN]/[OUT] key or [A]/[B] key) will go dark.



- If using the mouse, you can delete a locate point by clicking it in the locate point display and then clicking the DELETE button in the lower right of the display.
- The DELETE button is used only when operating the mouse. When using the top panel keys, you can delete simply by moving the cursor to the desired locate point or marker and pressing the [ENTER] key.

Deleting a locate point using the panel keys

A locate point (except for the Start/End points) can be deleted as follows using only the panel keys.

Deleting an In/Out point or A/B point

Hold down the [CANCEL] key, and press the key for the locate point that you wish to delete ([A]/[B] key or [IN]/[OUT] key). The locate point will be deleted, and the corresponding key will go dark.

Deleting a marker

Use the [◀]/[▶] keys to locate to the marker that you wish to delete. Then hold down the [CANCEL] key and press the [MARK] key. A message of "MARK ERASE" will briefly appear at the bottom of the display, indicating that the selected marker has been erased.

7 Punch-in/out

This chapter explains how to use punch-in/out.

About punch-in/out

Punch-in/out is a method for re-recording a portion of a previously recorded track. There are two types of punch-in/out.

Manual punch-in/out (→ P.128)

In this method you can punch in or out manually, using the transport keys of the AW4416 or a separately sold foot switch (Yamaha FC-5). If a foot switch is used, the entire procedure of playback → punch-in → punch-out → stop can be performed using your foot, which is convenient when you are playing an instrument while operating the AW4416.

Auto punch-in/out (→ P.130)

In this method, punch-in/out will occur automatically at the points that you specify ahead of time (the auto punch-in/out points). This method allows the location to be specified with sub-frame or millisecond accuracy, and lets you punch-in/out repeatedly. You can also practice (rehearse) the auto punch-in/out.

Manual punch-in/out

Here's how to perform manual punch-in/out.

Preparations

□ Make input monitor settings

For the track on which you wish to punch-in/out, you will need to monitor the track playback up to the punch-in point, and then monitor the input signal of the track (the recording source) after you punch-in. To do this, set the input monitor setting to “auto input monitor,” as explained below.

1. Press the [TRACK] key → [F1] key.

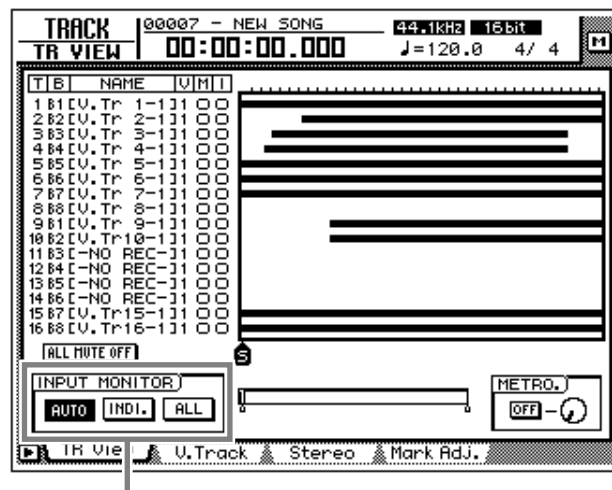

Input monitor setting

2. In the INPUT MONITOR area, move the cursor to the AUTO button and press the [ENTER] key.

The AUTO button will be turned on, and Auto Input Monitor will be selected as the input monitor setting.

□ Connect a foot switch

If you will be using a separately sold foot switch (Yamaha FC-5) to perform manual punch-in/out, connect the foot switch to the FOOT SW jack on the rear panel.



.....
 If a foot switch other than the Yamaha FC-5 is connected, it may not operate correctly.

Manual punch-in/out recording

1. Locate the song to a location earlier than where you wish to punch-in.



.....
 If you set a locate point such as a marker or the A/B point at this location, it will be convenient when you later check the recorded result or perform punch-in/out again.
 For details on setting a locate point, refer to page 114.

2. Press the [REC TRACK SELECT] key for the track that you wish to record. The [REC TRACK SELECT] key will blink, and the track will be in record-ready mode.
3. Press the [PLAY] key. (If you are using a foot switch, press the foot switch.)
The song will begin playing.
4. At the location where you wish to punch-in, hold down the [REC] key and press the [PLAY] key (or press the foot switch).
The [REC] key will light, and recording will begin on the track you selected in step 2.
5. At the location where you wish to punch-out, press the [PLAY] key (or press the foot switch).
The [REC] key will go dark, and you will return to normal playback mode.
6. To stop the song, press the [STOP] key (or press the foot switch).
The song will stop.
7. To check the recorded result, locate to the location of step 1, and press the [PLAY] key.



.....
 If you make a mistake during punch-in/out recording, stop the transport and press the [UNDO] key to cancel the previous recording and return the data to the state before recording.

The following diagram shows the manual punch-in/out procedure.

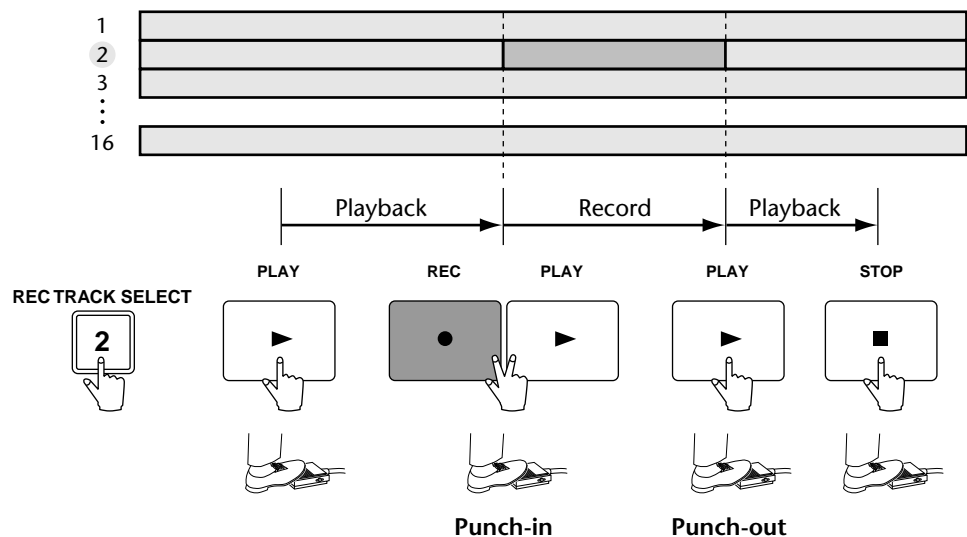

Auto punch-in/out

Here's how to use auto punch-in/out.

Preparations

❑ Make input monitor settings

To perform punch-in/out recording, you will need to select “auto input monitor” as the input monitor setting. For details refer to page 128.

❑ Set the auto punch-in/out points

Specify the location at which punch-in/out will start (Auto Punch In point) and end (Auto Punch Out Point). Auto punch-in/out uses the in/out point settings (→ P.120).

1. At the location where you wish to punch-in, hold down the [SET] key and press the [IN] key.
The [IN] key will light, indicating that the In point has been set.
2. At the location where you wish to punch-out, hold down the [SET] key and press the [OUT] key.
The [OUT] key will light, indicating that the Out point has been set.



.....
Be aware that auto punch-in/out will not occur if the Out point is earlier than the In point.



.....
Tip! The auto punch-in/out points (in/out points) can be precisely adjusted in milliseconds or in sub-frame units. For details refer to page 123.

❑ Set the pre-roll/post-roll times

When executing auto punch-in/out, you can specify intervals of playback before the punch-in and after the punch-out. The playback before punch-in is called the “pre-roll time,” and the playback after punch-out is called the “post-roll time.” With the factory settings, these are set to five seconds, but you can change this as desired. The beginning of the pre-roll is called the “pre-roll point,” and the end of the post-roll is called the “post-roll point.”

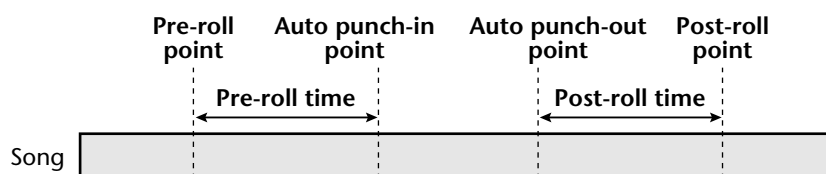

1. Press the [UTILITY] key → [F3] key.

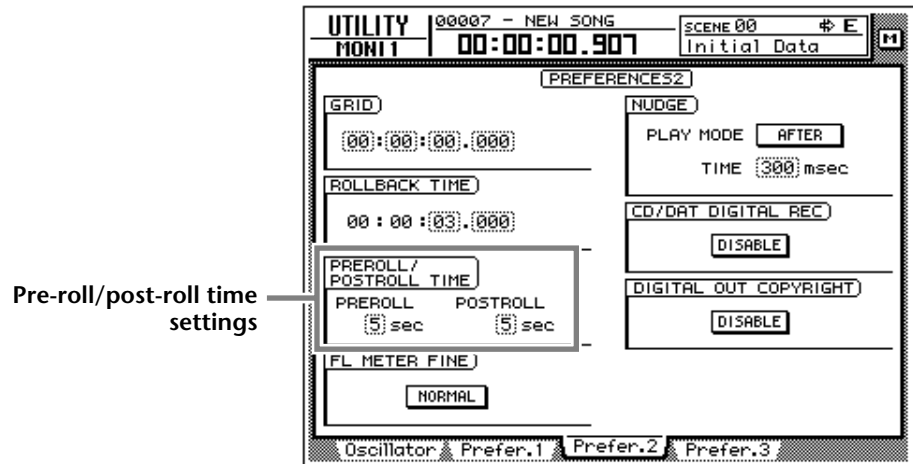

2. Move the cursor to the pre-roll (PREROLL) or post-roll (POSTROLL) fields, and use the [DATA/JOG] dial to set the pre-roll time and post-roll time.

Rehearsing and recording with auto punch-in/out

Rehearsing with auto punch-in/out

1. Press the [REC TRACK SELECT] key for the track that you wish to record using auto punch-in/out.
The [REC TRACK SELECT] key will blink, and the track will be in record-ready mode.
2. Make sure that the Locate section [IN]/[OUT] keys are lit, and press the [AUTO PUNCH] key.
The [AUTO PUNCH] key will light, and you will locate to the pre-roll point.



While the [AUTO PUNCH] key is lit, transport/locate operations other than the [STOP]/[PLAY]/[REC] keys cannot be used.

3. To begin rehearsing the auto punch-in/out, press the [PLAY] key.
 - ① The [PLAY] key will light, and playback will begin from the pre-roll point.
 - ② When you reach the auto punch-in point, the [REC] key will begin blinking, and the monitor signal of the track you selected in step 1 will change from the track playback to the input signal (recording source). However, recording will not actually occur.
 - ③ When you reach the auto punch-out point, the [REC] key will go dark, and the monitor signal will return to the track playback. (During rehearsal, recording will not actually occur.)
 - ④ When you reach the post-roll point, the transport will locate to the pre-roll point and stop.

- If you wish to rehearse once again, press the [PLAY] key once again while the transport is stopped.



.....
 If you press the [REHEARSAL] key before or during rehearsal, operations ①–④ of step 3 will continue repeating. (In this case, the A-B Repeat function will be defeated.) To stop repeating the rehearsal, press the [REPEAT] key once again, or press the [STOP] key.

□ Recording with auto punch-in/out

- To actually record using auto punch-in/out, stop the transport, and hold down the [REC] key and press the [PLAY] key.
 - The [PLAY] key will light and the [REC] key will blink, then playback will begin from the pre-roll point.
 - When you reach the auto punch-in point, the [REC] key will light, and recording will begin on the track you selected in step 1 (punch-in).
 - When you reach the auto punch-out point, the [REC] key will blink, recording will end, and playback will resume (punch-out).
 - When you reach the post-roll point, the transport will locate to the pre-roll point and stop.
- If you wish to listen to the recorded result, press the [AUTO PUNCH] key to make it go dark, and then press the [PLAY] key.



.....
 If you make a mistake during auto punch-in/out recording, stop the transport and press the [UNDO] key to cancel the previous recording and return the data to the state before recording.

The following diagram shows the operating procedure for auto punch-in/out.

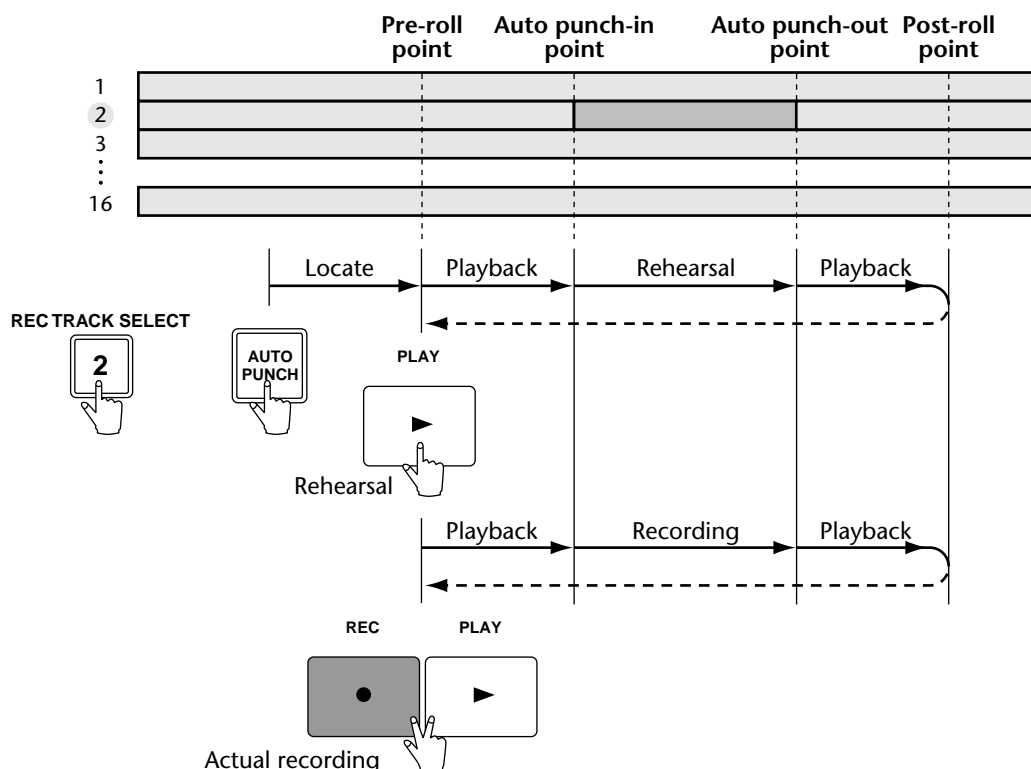

8 Patching

This chapter explains how to patch the inputs and outputs, and how to use the Quick Rec function to simultaneously record sixteen channels of input sources.

Patching to the input channels

When the AW4416 is in the default state, input signals are patched to input channels 1–24 as shown in the following diagram. However, you can change the input signals assigned to each input channel as necessary.

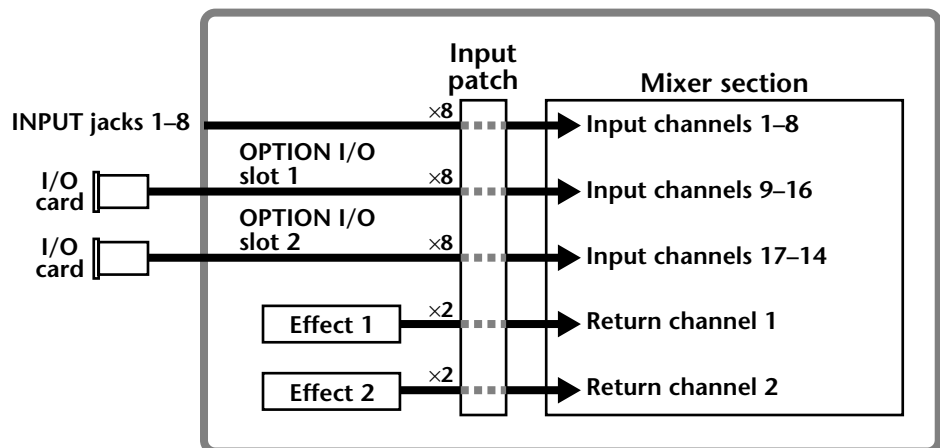

Here's how to patch input signals to input channels 1–24 and return channels 1/2.

1. Press the [SETUP] key → [F1] (Patch IN) key.

The display will show the SETUP screen Patch IN page, where you can patch signals to the input channels and recorder inputs. In this page, the MIXER CHANNEL INPUT ASSIGN column shows the patched status of input channels 1–24 and return channels 1/2.



.....
If the Patch IN tab is not assigned to the [F1] key, press the [SHIFT] key + [F1] key to switch the tabs, and then press the [F1] key.

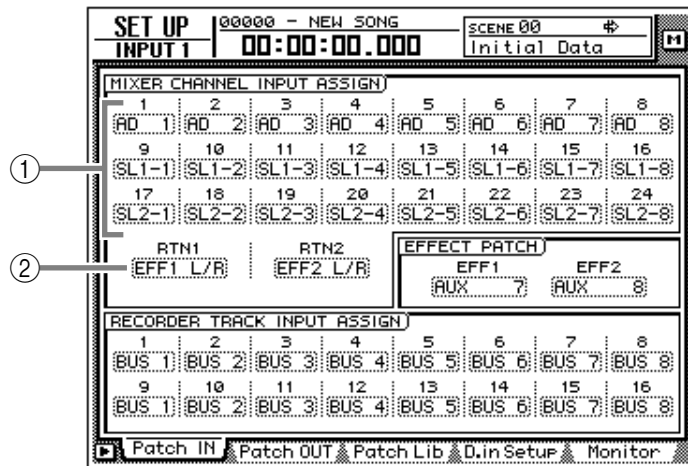

- ① Input channels 1–24
 - ② Return channels 1/2
2. Move the cursor to the channel that you wish to patch, and use the [DATA/JO] dial to select the signal that you wish to assign. The following signals can be assigned to each channel.

○ Input channels 1–24

Display	Type of signal
AD 1 – AD 8	INPUT jacks 1–8
SL1-1 – SL1-8	INPUT 1–8 of an I/O card (slot 1)
SL2-1 – SL2-8	INPUT 1–8 of an I/O card (slot 2)
DIN L/DIN R	L/R channels of the DIGITAL STEREO IN jack
SMP 1 – SMP 8	Sampling pads 1–8
MET	Internal metronome

○ Return channels 1/2

Display	Type of signal
EFF 1 L/R	Return from internal effect 1* ¹
EFF 2 L/R	Return from internal effect 2* ²
AD 1/2 – AD 7/8	INPUT jacks 1/2–7/8
SL1-1/2 – SL1-7/8	INPUT 1/2–7/8 of an I/O card (slot 1)
SL2-1/2 – SL2-7/8	INPUT 1/2–7/8 of an I/O card (slot 2)
DIN L/R	DIGITAL STEREO IN jack (stereo)

*1. Selectable only for return 1

*2. Selectable only for return 2



You can use the patch library to save the state of the patch settings you make. For details refer to page 138.

Patching to the recorder inputs

When the AW4416 is in the default state, buses 1–8 are assigned respectively to recorder inputs 1–8 and 9–16, but you can assign the direct signals from the input channels as desired.

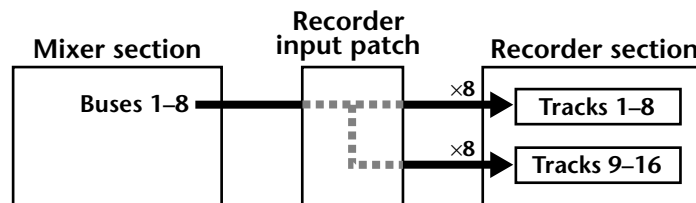

Here's how to assign the desired signals to recorder inputs 1–16.

1. Press the [SETUP] key → [F1] (Patch IN) key to access the SETUP screen Patch IN page.
The RECORDER TRACK INPUT ASSIGN column will indicate the patched status of recorder inputs 1–16.



If the Patch IN tab is not assigned to the [F1] key, press the [SHIFT] key + [F1] key to switch the tabs, and then press the [F1] key.

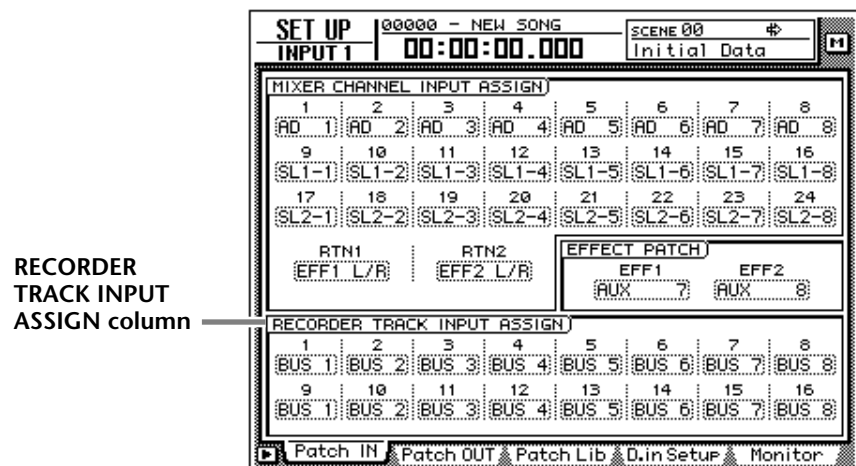

2. Move the cursor to the recorder input whose patching you wish to change, and use the [DATA/JOG] dial to select the signal that you wish to assign.

The following types of signal can be assigned to each input.

○ Recorder inputs 1–16

Display	Type of signal
BUS 1 – BUS 8	Buses 1–8
DIR 1 – DIR16	Input channel direct out 1–16

Patching to the outputs

When the AW4416 is in the default state, the following signals are assigned to the OMNI OUT jacks, STEREO OUT jacks, and digital I/O card outputs. If necessary, you can change the output signals that are assigned to these output jacks.

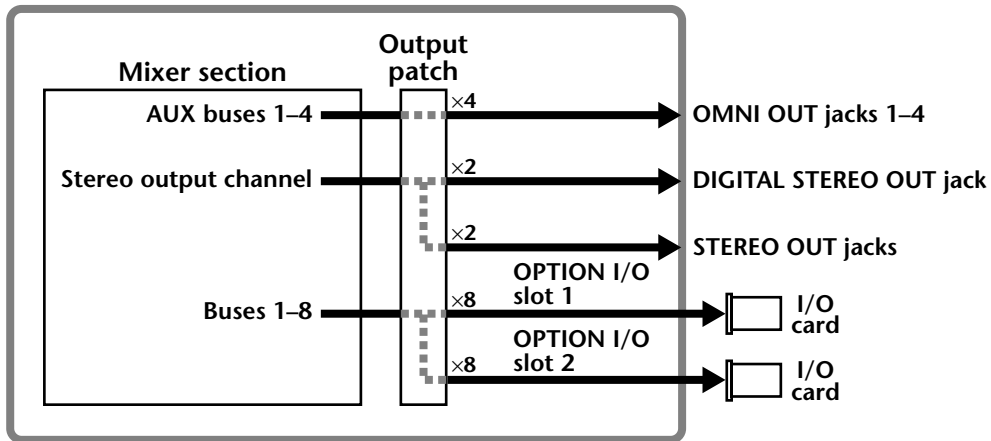

Here's how to assign the desired signal to each output jack.

1. Press the [SETUP] key → [F2] (Patch OUT) key.

The display will show the SETUP screen Patch OUT page. The various fields of the display will show the patched status of each output jack.



If the Patch OUT tab is not assigned to the [F2] key, press the [SHIFT] key + [F1] key to switch the tabs, and then press the [F2] key.

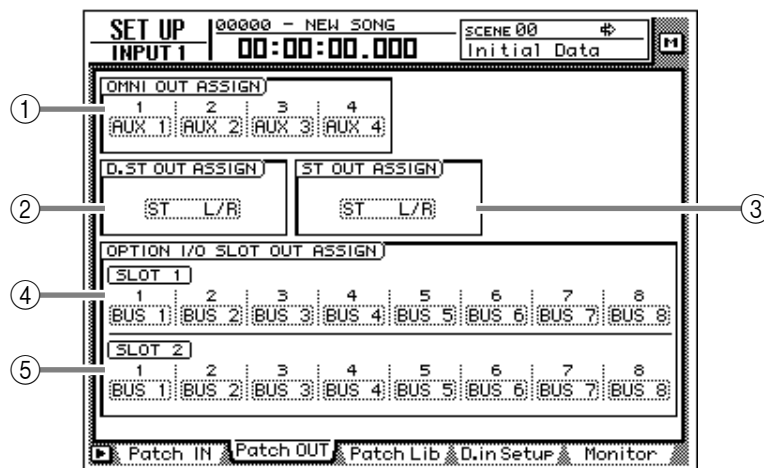

- ① OMNI OUT jack 1-4
- ② DIGITAL STEREO OUT jack
- ③ STEREO OUT jack
- ④ OUTPUT 1-8 of an I/O card (slot 1)
- ⑤ OUTPUT 1-8 of an I/O card (slot 2)

2. Move the cursor to the output jack whose patching you wish to change, and use the [DATA/JOG] dial to select the signal that you wish to assign. The following types of signal can be assigned to each output jack.

○ **OMNI OUT jacks 1–4**

Display	Type of signal
AUX 1 – AUX 8	AUX buses 1–8
RDR 1 – RDR16	Recorder direct out 1–16
ST L/ST R	L/R channels of the stereo output channel
BUS 1 – BUS 8	Buses 1–8
DIR 1 – DIR16	Input channel direct out 1–16

○ **DIGITAL STEREO OUT jack**

○ **STEREO OUT jacks**

Display	Type of signal
ST L/R	Stereo output channel
BUS 1/2 – BUS 7/8	Buses 1/2–7/8
DIR 1/2 – DIR15/16	Input channel direct out 1/2–15/16
AUX 1/2 – AUX 7/8	AUX buses 1/2–7/8
RDR 1/2 – RDR15/16	Recorder direct out 1/2–15/16

○ **Digital I/O card (slot 1) OUTPUT 1–8**

○ **Digital I/O card (slot 2) OUTPUT 1–8**

Display	Type of signal
BUS 1 – BUS 8	Buses 1–8
DIR 1 – DIR16	Input channel direct out 1–16
AUX 1 – AUX 8	AUX buses 1–8
RDR 1 – RDR16	Recorder direct out 1–16
ST L/ST R	L/R channels of the stereo output channel



When selecting a signal for assignment to an output jack, selections beginning with “I-” such as “I-I8” or “I-M16” may be displayed in gray. Selections beginning with “I-” indicate insert-out points of each channel. The gray display indicates that this insert point is invalid. (For details on insert I/O patching, refer to page 140.)

Patch library

Patch settings that you make in the SETUP screen Patch IN page and Patch OUT page can be stored in the patch library as one of twenty patch programs. The contents of the patch library are saved on the internal hard disk as part of the song. Here's how to use the patch library.

□ Storing to the patch library

Here's how to assign a name to your patch settings, and store them in the patch library.

1. Press the [SETUP] key → [F3] (Patch Lib) key.

The display will show the PATCH screen Patch Lib page. The list in the lower part of the display shows the contents of the patch library.



- If the Patch Lib tab is not assigned to the [F3] key, press the [SHIFT] key + [F1] key to switch the tabs, and then press the [F3] key.
- Patch library numbers in which no data has been stored will be displayed with a title of “[No Data!]”.

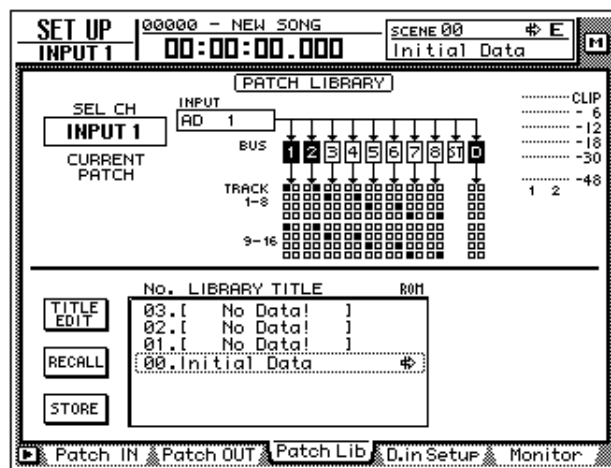

2. Use the [DATA/JOG] dial to select the patch library number (01–20) in which you will store the settings.



Patch library number 00 contains a preset patch program (recall-only) that returns all patch settings to the initial state. For this reason, your settings cannot be stored in patch number 00.

3. Move the cursor to the STORE button, and press the [ENTER] key.
A TITLE EDIT popup window will appear, allowing you to assign a name to the patch program.
4. Use the CURSOR [◀]/[▶]/[▲]/[▼] keys and the [ENTER] key to specify the name for the patch program.
For details on inputting characters, refer to page 60.



You can also write the patch program directly, without accessing the TITLE EDIT popup window. To do so, turn off the STORE CONFIRMATION setting in the UTILITY screen Prefer.1 page ([UTILITY] key → [F2] key). In this case, your settings will be saved in a library named "New Data" when you execute step 3.

- To execute the Store operation, move the cursor to the OK button and press the [ENTER] key.



If you decide to cancel without storing, move the cursor to the CANCEL button and press the [ENTER] key.

□ Recalling a patch program

Here's how to recall a patch program that you saved in the patch library.

- Press the [SETUP] key → [F3] (Patch Lib) key to access the SETUP screen Patch Lib page.
- Use the [DATA/JOG] dial to select the patch program that you wish to recall.
- Move the cursor to the RECALL button and press the [ENTER] key. A popup window will ask you to confirm the Recall operation.



You can also recall the patch program directly, bypassing the confirmation popup window. To do so, turn off the RECALL CONFIRMATION setting in the UTILITY screen Prefer.1 page ([UTILITY] key → [F2] key).

- To execute the Recall, move the cursor to the OK button and press the [ENTER] key.



If you decide to cancel without recalling, move the cursor to the CANCEL button and press the [ENTER] key.

Patching input/output jacks to an insert I/O point

You can patch various input/output jacks to the insert I/O point of a channel. This patching method allows you to apply an external effect to a monitor channel during mixdown.

1. Use the MIXING LAYER section keys and the [SEL] keys to select the channel whose insert I/O point you wish to patch to input/output jacks.

2. Press the [VIEW] key → [F1] key.

The display will show the VIEW screen CH View page. In the example shown here, monitor channel 1 is selected.

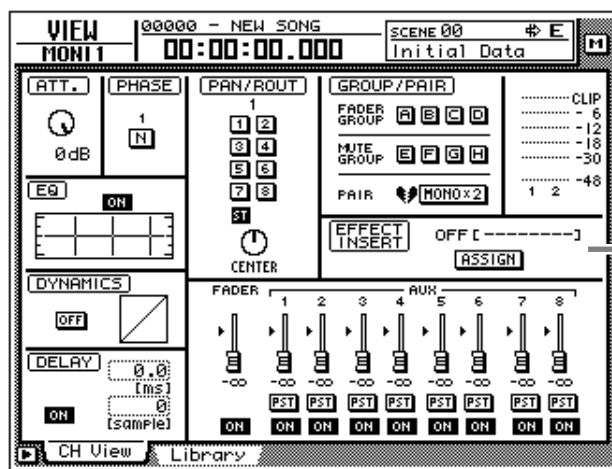

3. Move the cursor to the ASSIGN button of the EFFECT INSERT field, and press the [ENTER] key.

The EFF.INSERT SETTING popup window will appear. The SEND and RTN. fields of the popup window will respectively show the types of output jack and input jack that are patched.

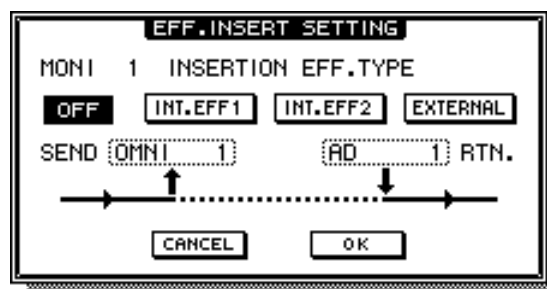

4. Move the cursor to the EXTERNAL button and press the [ENTER] key.

5. Move the cursor to the SEND field, and use the [DATA/JOG] dial to select the insert send jack.

You can select from the following jacks.

○ When selecting for an input channel 1–24 or a monitor channel 1–16

Display	Jack
OMNI 1 – OMNI 4	OMNI OUT jacks 1–4
SL1-1 – SL1-8	OUTPUT 1–8 of an I/O card (slot 1)
SL2-1 – SL2-8	OUTPUT 1–8 of an I/O card (slot 2)
D STO L ^{*1}	L channel of the DIGITAL STEREO OUT jack
D STO R ^{*2}	R channel of the DIGITAL STEREO OUT jack
STOUT L ^{*1}	L channel of the STEREO OUT jack
STOUT R ^{*2}	R channel of the STEREO OUT jack

*1. Selectable only for odd-numbered channels

*2. Selectable only for even-numbered channels

○ When selecting for a return channel 1/2 or the stereo output channel

Display	Jack
OMNI 1/2 – OMNI 3/4	OMNI OUT jacks 1/2–3/4
SL1-1/2 – SL1-7/8	OUTPUT 1/2–7/8 of an I/O card (slot 1)
SL2-1/2 – SL2-7/8	OUTPUT 1/2–7/8 of an I/O card (slot 2)
D STOUT	DIGITAL STEREO OUT jack (L/R)
STOUT	STEREO OUT jack (L/R)

6. Move the cursor to the RTN. field, and use the [DATA/JOG] dial to select the inert return jack.

You can select from the following jacks.

○ When selecting for an input channel 1–24 or monitor channel 1–16

Display	Jack
AD 1 – AD 8	INPUT jacks 1–8
SL1-1 – SL1-8	INPUT 1–8 of an I/O card (slot 1)
SL2-1 – SL2-8	INPUT 1–8 of an I/O card (slot 2)
D STIN L/D STIN R	L/R channels of the DIGITAL STEREO IN jack

○ When selecting for a return channel 1/2 or the stereo output channel

Display	Jack
AD 1/2 – AD 7/8	INPUT jacks 1/2–7/8
SL1-1/2 – SL1-7/8	INPUT 1/2–7/8 of an I/O card (slot 1)
SL2-1/2 – SL2-7/8	INPUT 1/2–7/8 of an I/O card (slot 2)
D ST L/R	DIGITAL STEREO IN jack (L/R)

7. When you have finished making patching settings, move the cursor to the OK button and press the [ENTER] key.

The EFFECT INSERT field will indicate “ON [EXTERNAL] ,” indicating that the selected input/output jacks have been patched to the insert I/O point.



.....
 To defeat the patching of an insert I/O point, use the ASSIGN button of the EFFECT INSERT field to access the EFF.INSERT SETTING popup window, turn on the OFF button, and select the OK button.



.....
 The procedure described above can be made for multiple channels. However, it is not possible for multiple insert sends to share the same output jack.

8. Press the [SETUP] key → [F2] (Patch OUT) key.

The display will show the SETUP screen Patch OUT page. Notice that OMNI OUT ASSIGN field 4 shows “I-M 1”. This means that OMNI OUT jack 4 is being used as an insert send jack for monitor channel 1.

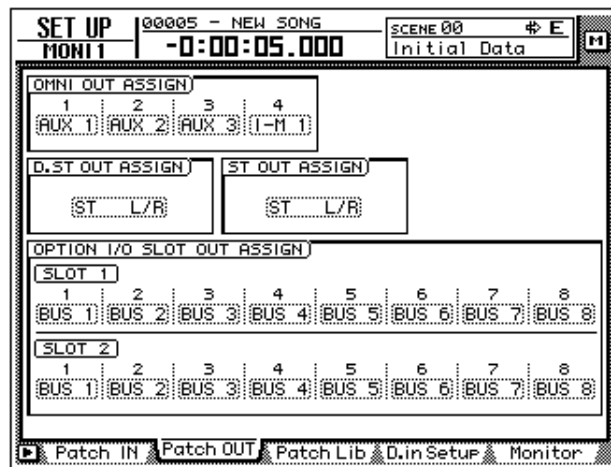

-
- In this case, changing the patching of OMNI OUT jack 4 in the Patch OUT page will defeat the insert I/O patching as well.
 - If you wish to save the patching and insert I/O point settings that you made here, you must store the current settings in a scene memory (not in the patch library or channel library).
 - The patch library cannot store insert I/O point settings. (When a patch program is recalled from the patch library, the insert I/O points of all channels will be reset to “OFF.”)
 - Patching information cannot be stored in the channel library.

Using the Quick Rec function

Quick Rec is a function that rapidly makes the appropriate settings so that you can simultaneously record sixteen input sources to audio tracks 1–16. When you execute Quick Rec, groups of eight input sources will be assigned directly to tracks 1–16, and input patch and mix parameter settings will also be reset. All that remains for you to do is to press the [REC] key + [PLAY] key, and you will be ready to record sixteen tracks simultaneously. This is convenient when you wish to transfer multiple tracks from an external MTR to the AW4416.

Here we will explain the procedure by which the input signals from I/O cards installed in slots 1 and 2 can be recorded simultaneously on tracks 1–16.



Tip!

When you execute Quick Rec, patching settings and mix parameters will be reset. If you will need to reproduce the current patching or mix settings, we recommend that you store the current scene into a scene memory before you execute Quick Rec. (→ P.211)

1. Press the [QUICK REC] key.
The display will show the QUICK REC screen.

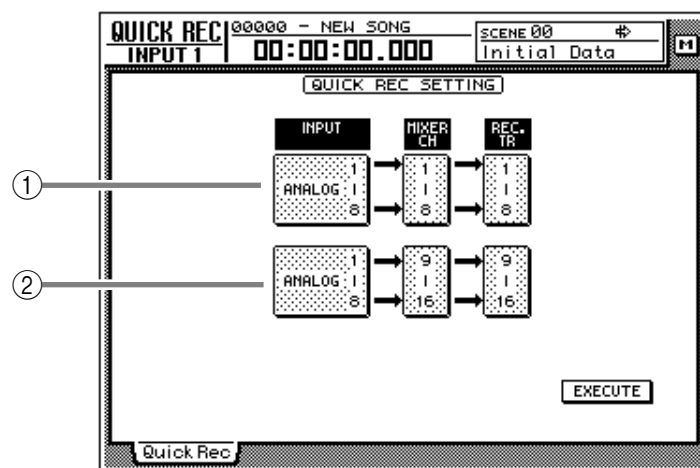

- ① Input jacks sent to track 1–8 inputs
 - ② Input jacks sent to track 9–16 inputs
2. Move the cursor to fields ①/② in the above screen, and use the [DATA/JOG] dial to select the input jacks that will be sent to the inputs of tracks 1–8/9–16.

You can select from the following choices. For this example, we will select “SLOT1 1–8” for tracks 1–8, and “SLOT2 1–8” for tracks 9–16.

- **ANALOG 1–8** INPUT jacks 1–8
- **SLOT1 1–8** INPUT 1–8 of an I/O card (slot 1)
- **SLOT2 1–8** INPUT 1–8 of an I/O card (slot 2)

3. Move the cursor to the EXECUTE button in the lower right of the display, and press the [ENTER] key.

A popup window will appear, asking you to confirm execution of Quick Rec.



4. To execute the Quick Rec settings, move the cursor to the OK button and press the [ENTER] key.

All [REC TRACK SELECT] keys will blink, and the input patch settings and mix parameters of each channel will be reset. At this time, the signal flow will be as follows.

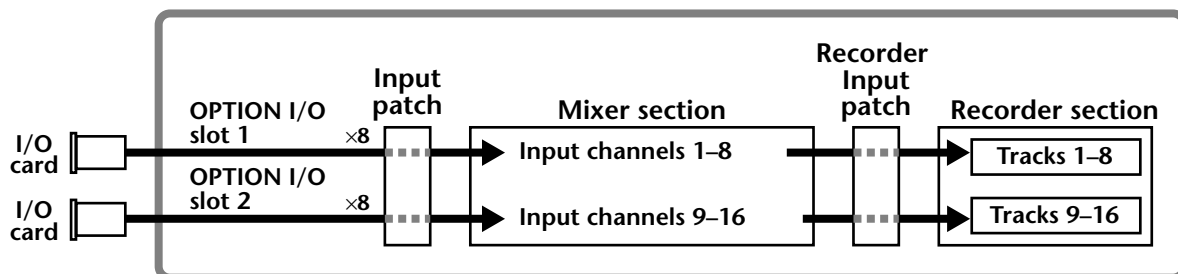

Tip!

- If you decide to cancel without executing Quick Rec, move the cursor to the CANCEL button and press the [ENTER] key.
- At this time, you can also turn off the blinking [REC TRACK SELECT] buttons to limit the number of recording tracks, or re-adjust the mix parameters and input patch settings of each channel.

5. Press the [TRACK] key → [F1] key.

The display will show the TRACK screen TR View page. As you can see from the display shown below, executing Quick Rec will turn input monitor on (I field= ●) for all tracks, and will mute (M field= ●) all tracks.

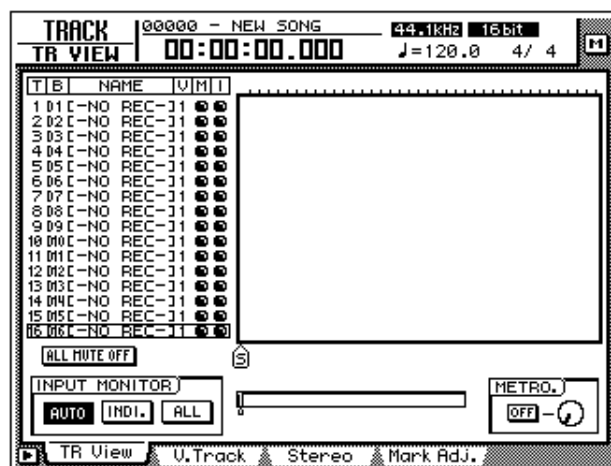

6. Play back the audio source connected to the input jacks of the I/O cards (slots 1/2).

The levels of the signals sent from the I/O card INPUT to tracks 1–16 (i.e., recording levels) will be displayed in the level meter/counter.

7. As necessary, use the faders of input channels 1–16 to adjust the recording level of tracks 1–16.

The faders of input channels 1–16 will be reset to nominal level (0 dB) when Quick Rec is executed. Adjust the recording level if necessary.



.....
If you wish to use the faders to adjust the recording level, the POST FADER button must be turned on in the DIRECT OUT EXTRACT POSITION field of the UTILITY screen → Prefer.1 page.

8. When you finish recording on the AW4416, press the [ALL SAFE] key. Record-ready and mute status will be canceled for all tracks.

9

Track and virtual track operations

This chapter explains the track structure of the recorder section, and how to perform editing and other operations.

The track structure of the AW4416

The recorder section of the AW4416 handles three types of tracks: audio tracks, virtual tracks, and the stereo track.

○ Audio tracks

These are physical tracks that are used for actual recording and playback, and are also referred to simply as “tracks.” When the AW4416 is in its initial state, the output of buses 1–8 is patched to the inputs of tracks 1–8/9–16, and the output of tracks 1–16 is patched to monitor channels 1–16. This allows a maximum of 16 tracks to be recorded simultaneously.

However, the number of tracks that can be played back simultaneously is limited by the number of tracks that are being recorded simultaneously. Be aware that tracks will automatically be muted depending on the number of simultaneously recorded tracks. The tables below show the numbers of tracks that can be recorded simultaneously and played back simultaneously, and the number of tracks that will be muted in each case.

• 16 bit song

Simultaneously recordable tracks	Simultaneously playable tracks	Automatically muted tracks
0–8	16	0
9–16	0	16

• 24 bit song

Simultaneously recordable tracks	Simultaneously playable tracks	Automatically muted tracks
0	16	0
1–2	14	2
3–4	12	4
5–8	8	8
9–16	0	16

For example if you simultaneously record nine or more tracks in a 16 bit song, no tracks can be played back simultaneously, meaning that the moment you put the ninth track in record-ready mode (the instant you turn on the ninth [REC TRACK SELECT] key), tracks 1–16 will all be muted automatically.

To defeat muting of tracks 1–16, you must first reduce the number of record-ready tracks to eight tracks or fewer, and then use the TRACK screen TR View page ([TRACK] key → [F1] key) to manually un-mute each track. (For details refer to Reference Guide “TRACK screen.”)

By pressing the [ALL SAFE] button in the level meter/counter section, you can cancel record-ready/mute status for all tracks at once. It is convenient to use this method as a shortcut when you wish to quickly cancel the mute settings and redo the settings.

○ Virtual tracks

These are “virtual” tracks from which you can select. On the AW4416, recording and playback will occur on the virtual track 1–8 that you select for each audio track 1–16.

The following diagram shows the concept of virtual tracks. The horizontal rows represent audio tracks 1–16, and the vertical columns represent virtual tracks 1–8. The shaded areas indicate the virtual tracks that are currently selected for recording and playback.

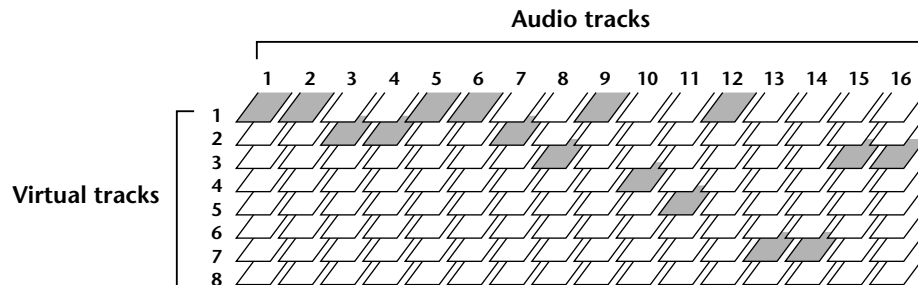

For example if you are recording a solo part on a certain track, you can switch virtual tracks to record multiple takes, and select the best take later.



Tip!

.....
In the initial state of the AW4416, virtual track 1 is selected for all tracks.

○ Stereo track

This is a stereo track that is independent of the audio tracks, and is used mainly as a master track to create a two-track mix. The AW4416 provides one stereo track for each song.

The input of the stereo track is internally connected to the stereo bus, so that you can record the signal of the stereo bus at any time simply by putting the stereo track in record mode. At this time, recording on the normal audio tracks 1–16 will not be possible. These tracks will only play back.

When you play back the stereo track, the output of the stereo track is automatically assigned to monitor channels 1/2. At this time, all of the normal audio tracks will be muted.

Switching virtual tracks

Here's how to switch the virtual track that a specific track will use.

1. Press the [TRACK] key → [F2] key.
The TRACK screen V.Track page will appear in the display.

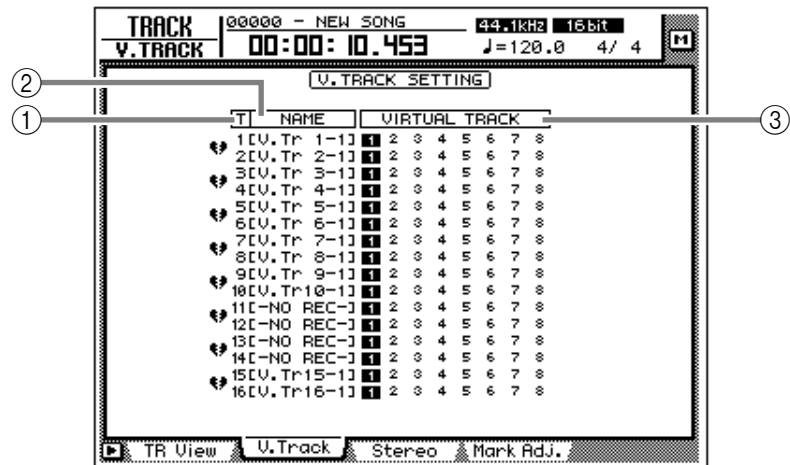

This page shows the following information.

① **Track number**

These are the track numbers 1–16.

② **Track name**

These are the names assigned to the virtual track currently selected for each track. By default, virtual tracks that have already been recorded will be named “V.Tr x-y” (“x” will be a track number 1–16, and “y” will be a virtual track number 1–8). This name can be changed later as desired (→ P.153). Virtual tracks that have not yet been recorded will be displayed as “-NO REC-”.

③ **Virtual track**

The highlighted number is the virtual track number currently selected for track 1–16. In the screen shown above, virtual track 1 is assigned to all tracks 1–16 (default setting).

Of the currently selected virtual tracks, the numbers of tracks that have already been recorded will be enclosed by a square; e.g., **1**.

2. Move the cursor to the virtual track number that you wish to assign to track 1, and press the [ENTER] key.

The virtual track number you select will be highlighted. Now you can record and play back the newly selected virtual track without affecting the previous virtual track.

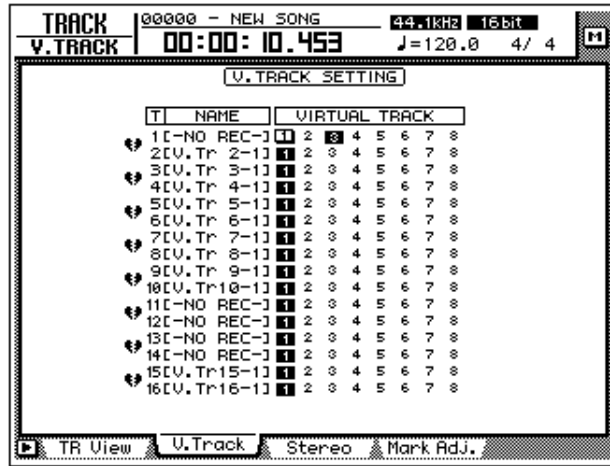

Pairing tracks

Adjacent odd-numbered → even-numbered tracks (tracks 1/2, tracks 3/4 ... tracks 15/16) can be set as a stereo pair. Paired tracks will always operate in tandem, such as when tracks are selected for editing, or when you switch virtual tracks. For example if you pair two tracks on which a stereo source was recorded, both tracks can be processed by a single operation, for greater convenience.



Even if tracks are paired, this will not affect the pairing settings of the monitor channels. If necessary, you can make separate settings to pair the monitor channels of these tracks as well.

1. Press the [TRACK] key → [F2] key.

The TRACK screen V.Track page will appear. The heart symbols in the left of the display indicate the current pairing status. Paired tracks are connected by a heart symbol.

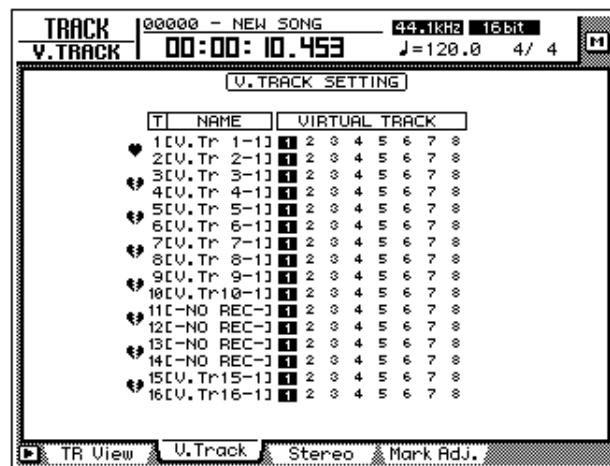

2. To create a pair, move the cursor to the corresponding heart symbol (♥), and press the [ENTER] key.

The heart symbol will be connected, and the two tracks will be paired. To cancel pairing, move the cursor to the heart symbol once again, and press the [ENTER] key.

Editing tracks and virtual tracks

A variety of editing operations can be performed on the audio data recorded on tracks 1–16 of the AW4416, such as copying data between tracks, moving data to an earlier or later location within the same track, or changing the pitch. In the same way, you can also copy or move data between the virtual tracks 1–8 that are included in each track. The following pages explain how to edit tracks and virtual tracks.

Tracks, parts, and regions

Track and virtual track editing can be performed in three editing units.

○ Track

The entire currently selected track (1–16) or virtual track (1–8) will be affected by the editing operation. When editing in units of a track, tracks that contain no audio data cannot be selected.

○ Part

Within the currently selected track (1–16) or virtual track (1–8), the currently selected range is called the “part.” Unlike the case when editing tracks, portions that contain no audio data can be selected as a part.

○ Region

A continuous piece of audio that was recorded on a track in a single operation is called a “region.” When editing in units of a region, portions that contain no audio data cannot be selected.

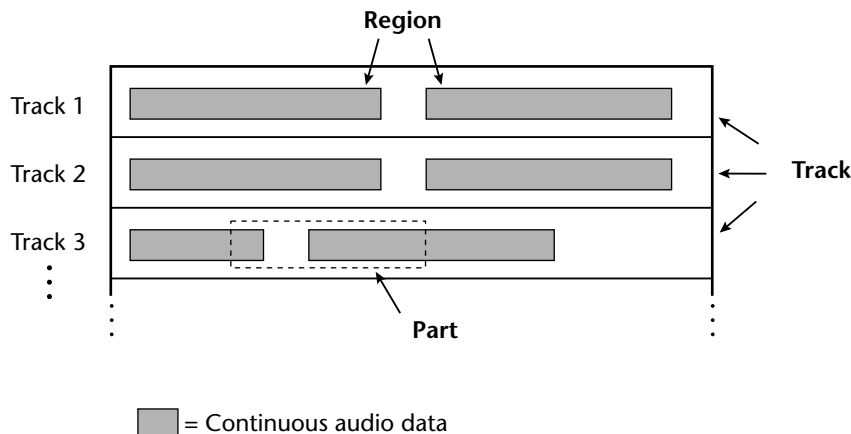

Tip!

.....
It is possible for a single track or a single part to include multiple regions.

Naming a virtual track or region

When you record something on a track, the following default name will be assigned to that virtual track.

- **Default virtual track name** .. V.Tr x-y (x=track number, y=virtual track number)
- **Default region name** VTxy (x=track number, y=virtual track number)



.....
If multiple regions exist in the same track (i.e., if you recorded the track in more than one stage), all the default region names will be the same.

These track names and region names can be modified using the following procedure.

□ Naming a virtual track

1. In the RECORDER section, press the [EDIT] key → [F1] key.
The EDIT screen TR Edit page will appear.
2. Move the cursor to the TRACK menu and press the [ENTER] key.
The TRACK menu will show the available editing commands.

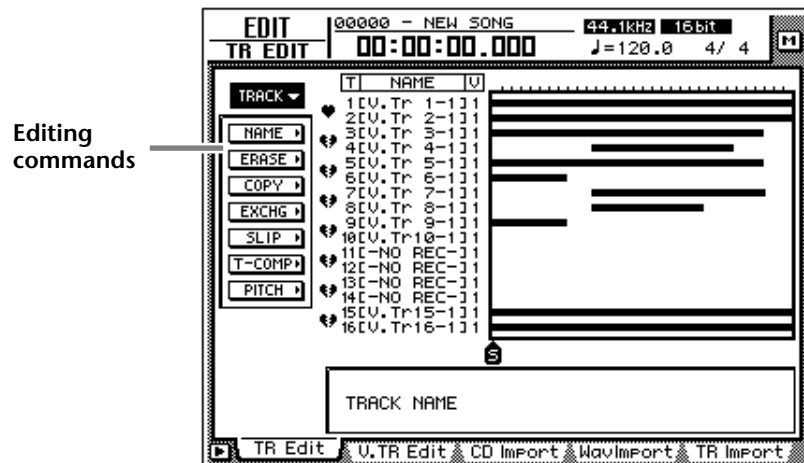

3. Move the cursor to the NAME menu and press the [ENTER] key. Buttons to specify NAME menu options will appear.

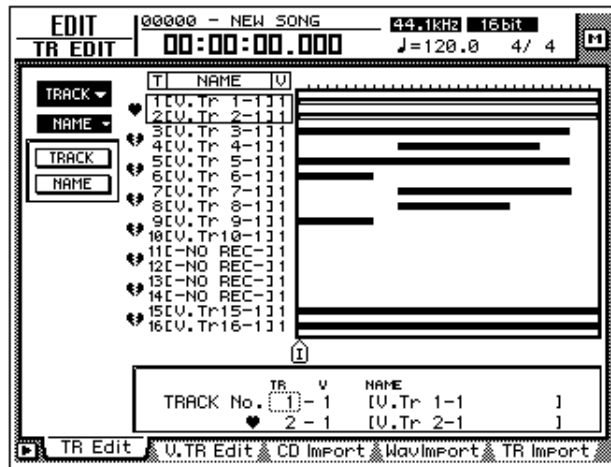

4. Move the cursor to the TRACK button and press the [ENTER] key. The cursor will move to the area at the bottom of the screen.

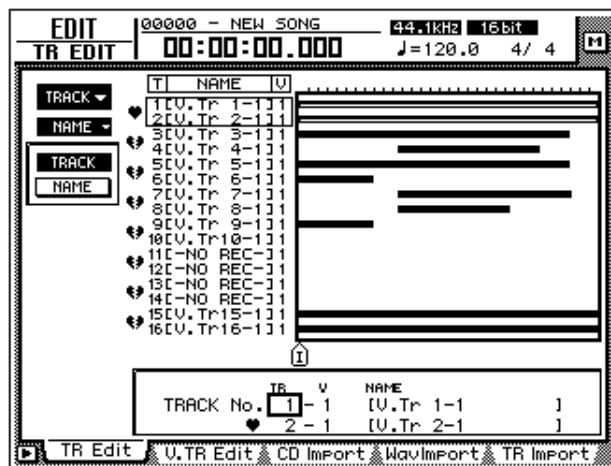

5. Use the [DATA/JOG] dial to select the track that you wish to name, and press the [ENTER] key.

- Move the cursor to the NAME button and press the [ENTER] key.
A NAME EDIT popup window will appear, allowing you to assign a name to the track/region.



- When you have finished inputting the name, move the cursor to the OK button and press the [ENTER] key. (For details on inputting characters, refer to page 60.)

You will return to the screen of step 1.



You can assign a track name of up to 16 characters. In the TRACK screen etc., the first eight characters of the name will be displayed.

□ Naming a region

- In the RECORDER section, press the [EDIT] key → [F1] key.
The EDIT screen TR Edit page will appear.
- Move the cursor to the REGION menu and press the [ENTER] key.
The REGION menu will show the available editing commands.

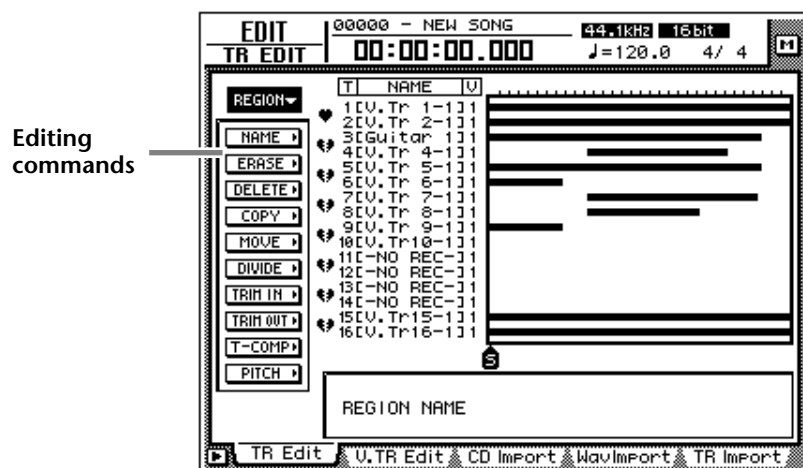

- Move the cursor to the NAME menu and press the [ENTER] key.
Buttons to specify NAME menu options will appear.
- Move the cursor to the REGION button and press the [ENTER] key.
The cursor will move to the area at the bottom of the screen.

5. Use the CURSOR [**◀**]/[**▶**]/[**▲**]/[**▼**] keys to select the region that you wish to name, and press the [ENTER] key.
6. Move the cursor to the NAME button and press the [ENTER] key.
A NAME EDIT popup window will appear, allowing you to assign a name to the region.
7. When you have finished inputting the name, move the cursor to the OK button and press the [ENTER] key. (For details on inputting characters, refer to page 60.)
You will return to the screen of step 1.



Tip!
You can assign a region name of up to 8 characters.

Track editing procedure

Here's the basic procedure for editing tracks, parts, or regions for audio tracks 1–16.

1. In the RECORDER section, press the [EDIT] key → [F1] key.
The EDIT screen TR Edit page will appear.

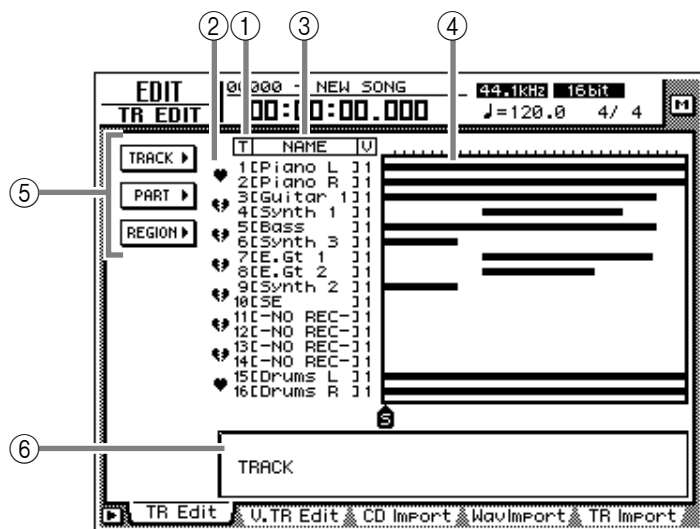

This screen shows the following information.

- ① **Track number**
This is the track number 1–16.
- ② **Pair**
This shows the pairing status for adjacent odd-numbered → even-numbered tracks. Pairing can also be set or defeated in this screen.
- ③ **Track name**
This is the name assigned to each virtual track.
- ④ **Bar graph**
Bar graphs indicate the presence or absence of audio data for each track.

⑤ TRACK/PART/REGION menus

These respectively access editing commands for editing entire tracks, parts, or regions. Move the cursor to the desired menu, and press the [ENTER] key to view the list of editing commands.

⑥ Parameter setting area

In this area you can make the necessary parameter settings when executing the editing command.

2. According to the smallest unit (track/part/region) that you wish to edit, move the cursor to the TRACK, PART, or REGION menu and press the [ENTER] key.

The selected menu of editing commands will appear. The following screen shows the commands that appear when the TRACK menu is selected.

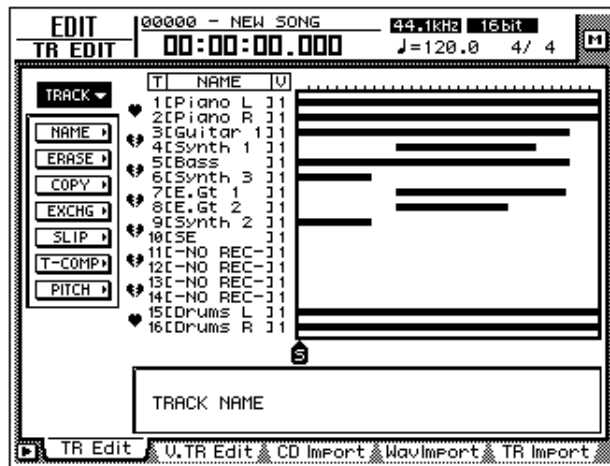

3. Move the cursor to the desired editing command and press the [ENTER] key.

Buttons to set the parameters for the selected editing command will appear. The screen shown below is an example of when the TRACK menu COPY command is selected.

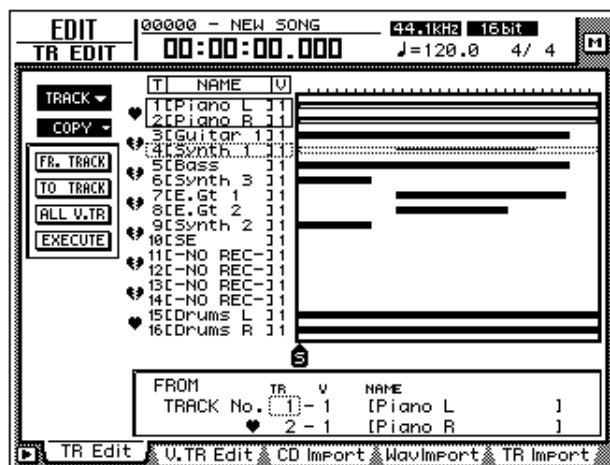

Page 161 provides brief explanations of the editing commands of each menu. For details of each command, refer to the Reference Guide.

- To change the parameter settings, move the cursor to the corresponding button.

The lower part of the display will show the settings of the parameter at which the cursor is currently located.

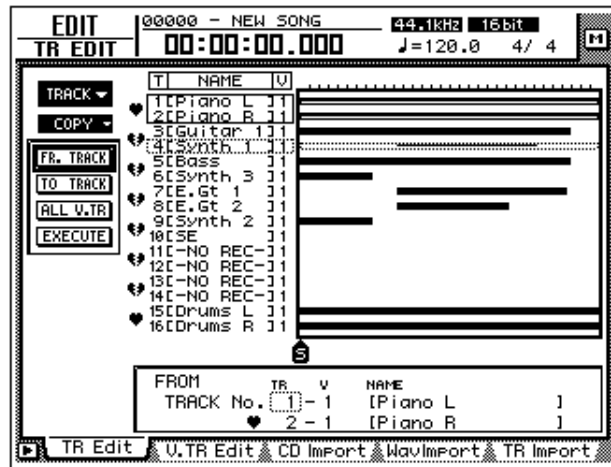

- Press the [ENTER] key.

The cursor will move to the setting area in the lower part of the display. The screen shown below is an example of when the COPY command is selected.

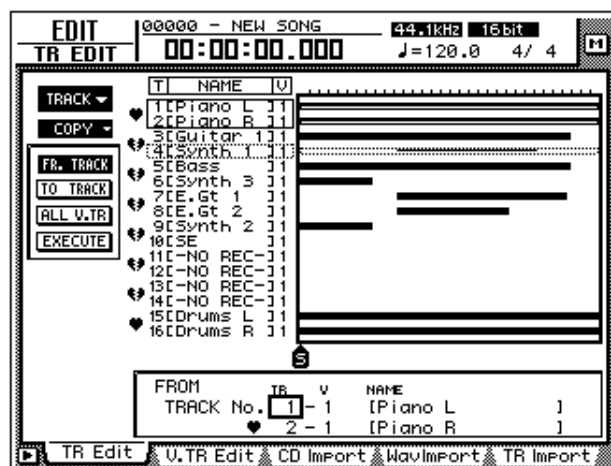

- Use the [DATA/JOG] dial to modify the parameter value, and press the [ENTER] key.

The cursor will return to the button selected in step 4.



Tip!

.....
If you decide to cancel without executing the editing command, move the cursor from here to a button at a higher level, and press the [ENTER] key.

- Repeat steps 4–6 to make settings for the remaining parameters.

- To execute the editing command, move the cursor to the EXECUTE button, and press the [ENTER] key.

The editing command you selected in step 3 will be executed.



- If you wish to halt the editing operation, move the cursor to a button in the top level, and press the [ENTER] key.
- As exceptions, the TRACK menu NAME command and the REGION menu NAME command do not require you to use the EXECUTE button.
- Even after executing an editing command, you can use the [UNDO] button to cancel the results of the operation. (The TRACK menu NAME command and the REGION menu NAME command are exceptions to this.)

Virtual track editing procedure

Here's the basic procedure for editing entire tracks, parts, or regions for virtual tracks 1–8 of the desired track.

- In the RECORDER section, press the [EDIT] key → [F2] key. The EDIT screen V.TR Edit page will appear, where you can edit virtual tracks.

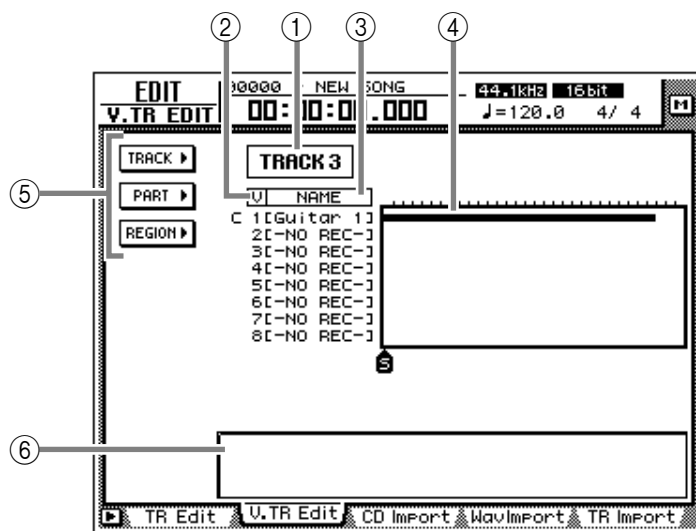

This screen shows the following information.

① **Track number**

This is the track number (1–16) currently selected for editing.

If this track is paired, a heart symbol and the other track of the pair will be displayed.

② **Virtual track number**

This is the virtual track number 1–8.

③ **Track name**

This is the name assigned to the virtual track.

④ **Bar graph**

Bar graphs indicate the presence or absence of audio data for each virtual track.

⑤ **TRACK/PART/REGION menus**

These respectively access editing commands for editing entire tracks, parts, or regions. Move the cursor to the desired menu, and press the [ENTER] key to view the list of editing commands.

⑥ **Parameter setting area**

In this area you can make the necessary parameter settings when executing the editing command.

2. Move the cursor to the track number area and use the [DATA/JOG] dial to select the track (1–16) that you wish to edit.

When you switch tracks, the track names and bar graph display of virtual tracks 1–8 will change accordingly.

3. According to the smallest unit (entire virtual track/part/region) that you wish to edit, move the cursor to the TRACK, PART, or REGION menu and press the [ENTER] key.

The selected menu of editing commands will appear.



.....

Page 161 provides brief explanations of the editing commands of each menu. For details of each command, refer to the Reference Guide.

4. Move the cursor to the desired editing command and press the [ENTER] key.

Buttons to set the parameters for the selected editing command will appear.

5. To change the parameter settings, move the cursor to the corresponding button.

The lower part of the display will show the settings of the parameter at which the cursor is currently located.

6. Press the [ENTER] key.

The cursor will move to the setting area in the lower part of the display.



.....

If you decide to cancel without executing the editing command, move the cursor from here to a button at a higher level, and press the [ENTER] key.

7. Use the [DATA/JOG] dial to modify the parameter value, and press the [ENTER] key.

The cursor will return to the button selected in step 4.

8. Repeat steps 5–7 to make settings for the remaining parameters.

9. To execute the editing command, move the cursor to the EXECUTE button, and press the [ENTER] key.

The editing command you selected in step 4 will be executed.



Tip!

- If you wish to halt the editing operation, move the cursor to a button in the top level, and press the [ENTER] key.
- As exceptions, the TRACK menu NAME command and the REGION menu NAME command do not require you to use the EXECUTE button.
- Even after executing an editing command, you can use the [UNDO] button to cancel the results of the operation. (The TRACK menu NAME command and the REGION menu NAME command are exceptions to this.)

Editing command list

This section provides brief explanations for the editing commands of the TRACK/PART/REGION menus for tracks and virtual tracks. Details and parameters for each command are given in the Reference Guide.

TRACK menu

These commands edit entire tracks or entire virtual tracks.

○ **NAME (Track Name)**

Assign a name to an already-recorded virtual track.

○ **ERASE**

Erase the audio data of the selected track.

○ **COPY**

Copy the audio data of the selected track to another track. The Fr.Track (From Track) parameter specifies the copy source track, and the To Track parameter specifies the copy destination track.

○ **EXCHG (Exchange)**

Exchange the audio data of two selected tracks. The Fr.Track (From Track) and To Track parameters specify the tracks to be exchanged.

○ **SLIP**

Move all audio data of the selected track forward or backward. The SLIP parameter specifies the distance of the movement (maximum ± 5 hours).

○ **T-COMP (Time Compression/Expansion)**

Compress or expand the length of the audio data in the selected track without affecting the pitch. The RATIO parameter specifies the amount of compression or expansion (50%–200%).

○ **PITCH (Pitch Change)**

Change only the pitch without affecting the length of the audio data. The PITCH parameter specifies the change in semitones (maximum ± 12 semitones) and the FINE parameter specifies the change in one-cent steps (maximum ± 50 cents).

PART menu

These commands edit data in units of parts. When using these commands, you will need to specify not only the track for editing, but also the editing start location (START) and end location (END).

○ ERASE

Erase the audio data of the selected part. Audio data following that part will not be affected.

○ DELETE

Delete the audio data of the selected part. Audio data following that part will move forward by the length of the deleted data.

○ COPY

Copy the audio data of the selected part to the specified location of the specified track. You can also specify the number of times the data will be copied, and the interval between copies. If audio data exists at the destination, you can specify whether the copied data will be inserted or overwritten.

○ MOVE

Move the audio data of the selected part to the specified location of the specified track. At this time, the audio data of the move source will be erased. If audio data exists at the destination, you can specify whether the moved data will be inserted or overwritten.

○ INSERT

Insert silence into the selected part. Audio data following that part will move backward by the length of the inserted data.

○ T-COMP (Time Compression/Expansion)

Compress or expand the length of the audio data in the selected track without affecting the pitch. The RATIO parameter specifies the amount of compression or expansion (50%–200%).

○ PITCH (Pitch Change)

Change only the pitch without affecting the length of the audio data of the selected part. The PITCH parameter specifies the change in semitones (maximum ± 12 semitones) and the FINE parameter specifies the change in one-cent steps (maximum ± 50 cents).

REGION menu

These commands edit data in units of regions.

NAME

Assign a name to a region.

ERASE

Erase the selected region. Audio data following that region will not be affected.

DELETE

Delete the selected region. Audio data following that region will move forward by the length of the deleted data.

COPY

Copy the selected region to the specified location of the specified track. You can also specify the number of times the data will be copied, and the interval between copies. If audio data exists at the copy destination, you can specify whether the copied data will be inserted or overwritten.

MOVE

Move the selected region to the specified location of the specified track. At this time, the move source region will be erased. If audio data exists at the move destination, you can specify whether the moved data will be inserted or overwritten.

DIVIDE

Divide the selected region into two at the location you specify.

TRIM IN

Trim the starting location of the selected region toward the end in sample units.

TRIM OUT

Trim the ending location of the selected region toward the beginning in sample units.

T-COMP (Time Compression/Expansion)

Compress or expand the length of the audio data in the selected track without affecting the pitch. The **RATIO** parameter specifies the amount of compression or expansion (50%–200%).

PITCH (Pitch Change)

Change only the pitch without affecting the length of the audio data of the selected region. The **PITCH** parameter specifies the change in semitones (maximum ± 12 semitones) and the **FINE** parameter specifies the change in one-cent steps (maximum ± 50 cents).

10 Internal effects

This chapter explains the two built-in effects of the AW4416.

About the internal effects

The AW4416 contains two multi-effect units (respectively called “effect 1” and “effect 2”). In general, the internal effects can be used in the following two ways.

Using AUX send/return

In this method, the two AUX sends are used to send signals from each channel to the inputs of effects 1/2, and the outputs of effects 1/2 are mixed with the signals of the stereo bus or buses 1–8. When the AW4416 is in the default state, AUX send 7/8 are patched to the inputs of effects 1/2, and the outputs of effects 1/2 are patched to return channels 1/2.

The signals sent from input channels 1–24 and monitor channels 1–16 to AUX buses 7/8 are input to effects 1/2 respectively. For each channel, you can adjust the AUX 7/8 send levels and switch between pre- or post-fader.

The output signals from effects 1/2 are sent to return channels 1/2. By routing the return channels to buses 1–8 or the stereo bus, they can be mixed with the original sound of each channel.

Inserting an effect into a channel

If you defeat the assignment of effect 1/2 to AUX send 7/8, you can insert an effect into the desired channel (immediately before the attenuator). In this case, the mixed effect and direct signals will be input to the corresponding channel. An effect that is used for insertion cannot be inserted into another channel, or used via send/return.

Effects can be inserted into the following channels.

- **Input channels 1–24**
- **Monitor channels 1–16**
- **Return channels 1/2**
- **Stereo output channel**

Using AUX send/return to apply an effect

As an example of using an effect with AUX send/return, here's how to apply effect 1 via AUX bus 7.

□ Patching

Make sure that the AUX send/return patching for effect 1 is appropriate.

1. Press the [SETUP] key → [F1] (Patch IN) key.
The SETUP screen Patch IN page will appear.

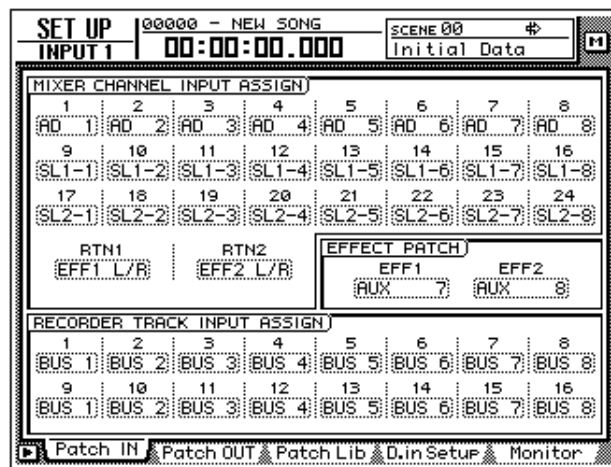

If the Patch IN tab is not assigned to the [F1] key, press the [SHIFT] key + [F1] key to switch the tab, and then press the [F1] key.

2. Make sure that the EFFECT PATCH parameter EFF1 is set to “AUX 7.”
The EFFECT PATCH parameters select whether effects 1/2 will be used via AUX or inserted into a specific channel. By default, EFF1 (effect 1) is assigned to AUX 7 and EFF2 (effect 2) is assigned to AUX 8, as shown above.



If EFF1 is set to “INSERT,” move the cursor to the “INSERT” field and use the [DATA/JOG] dial to change it to “AUX 7.” Then move the cursor to the OK button and press the [ENTER] key.

3. Make sure that the MIXER CHANNEL INPUT ASSIGN parameter RTN1 is set to “EFF1 L/R.”
The MIXER CHANNEL INPUT ASSIGN area switches the signal that is assigned to the input channel/return channel of the mixer. By default, “EFF1 L/R” (L/R output of effect 1) is assigned to RTN1 (return channel 1).



If RTN1 has been changed to another setting, move the cursor to the setting area, and rotate the [DATA/JOG] dial to change the setting to “EFF 1 L/R.”

□ Recalling an effect program from the library

The AW4416 provides 41 effect types such as Reverb Hall, Gate Reverb, and Stereo Delay. The effect type library contains factory-set effect programs that use these effect types. Here's how to recall an effect program of the effect type you wish to use.

1. Press the [AUX 7] key → [F2] key.

The AUX7/EFF1 screen Library page will appear. A list of effect programs will be displayed.

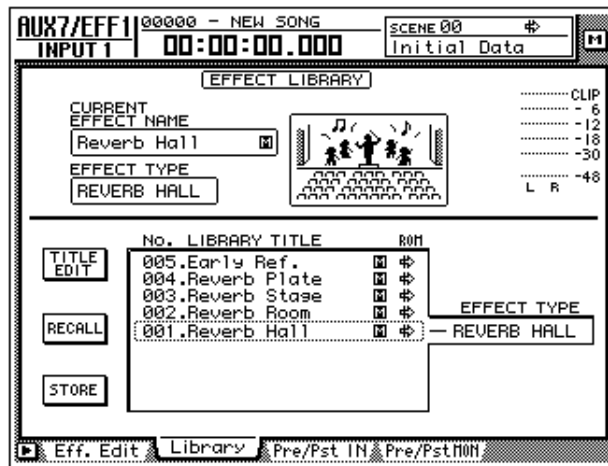

- In general, the effect library is common to both effects 1 and 2. However, effect program no. 19 "HQ-Pitch" can be used only by effect 2.
- Effect library 001–041 contain read-only effect programs using the corresponding effect type.
- It is not possible to change the effect type of the currently used effect program. For this reason, you must load a program that uses the desired effect type from the library even if you wish to create an effect program from scratch.

2. Move the cursor to the list, and rotate the [DATA/JOG] dial to select the program that you wish to recall.

When you select a program, the effect type used by that program will be displayed at the right of the list. For this example, let's select the room reverb program "Reverb Room."

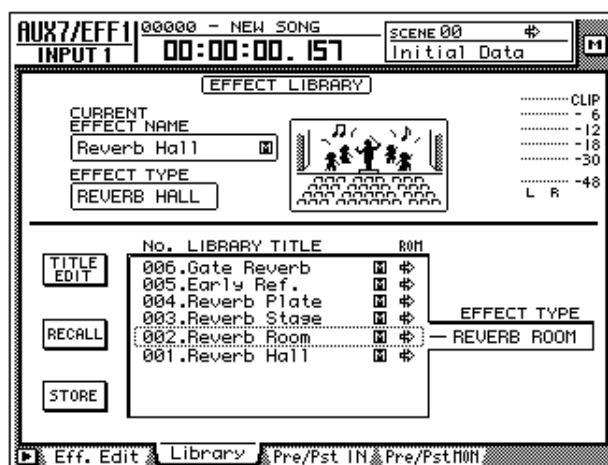

3. Move the cursor to the RECALL button, and press the [ENTER] key. A popup window will appear, asking you to confirm the recall operation.



It is also possible to recall the effect program directly, without displaying the popup window that asks you to confirm the recall operation. To do so, access the UTILITY screen Pref. 1 page ([UTILITY] key → [F2] key), and turn RECALL CONFIRMATION off.

4. To recall the program, move the cursor to the OK button and press the [ENTER] key.

The effect program will be recalled. The name of the recalled program will appear in the “CURRENT EFFECT NAME” area in the upper left of the display.

5. Press the [F1] key.

The Eff.Edit page will appear in the display.

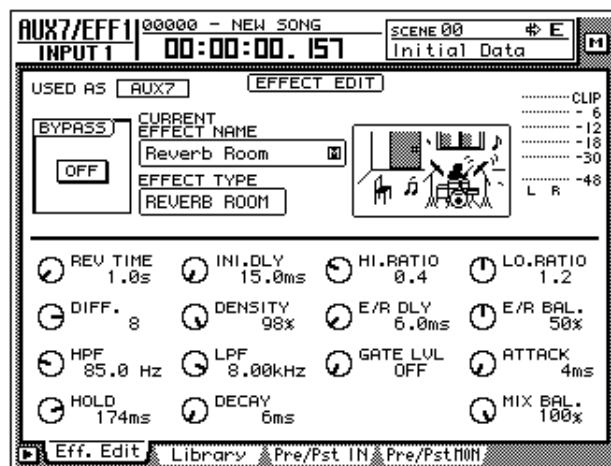

6. Make sure that the MIX BAL knob located in the lower right of the display is set to 100%.

The Eff.Edit page allows you to edit the effect parameters. Regardless of the effect type that is selected, the MIX BAL (a parameter that adjusts the balance between the dry and effect sounds) knob will be located in the lower right of the Eff.Edit page.

When using an effect via AUX send/return, you will need to set this parameter to 100% so that the effect will output only the “wet” (processed) sound. To adjust this setting, move the cursor to the MIX BAL knob, and rotate the [DATA/JOG] dial.



- Other effect parameters can be edited in the same way by moving the cursor to them and rotating the [DATA/JOG] dial.
- For the type and function of the effect parameters of each effect type, refer to the Reference Guide.

□ Switching between pre-fader and post-fader

For each monitor channel, you can select the location (pre-fader or post-fader) from which the signal will be sent to AUX 7.

1. Press the [AUX 7] → [F4] key.

The Pre/PstMON page will appear, where you can make pre-/post-fader settings for monitor channels 1–16.

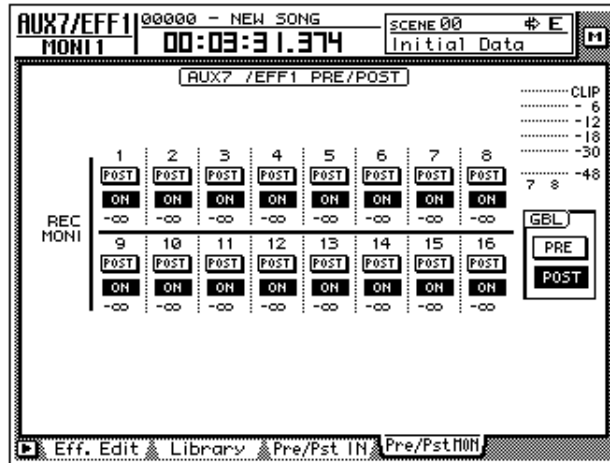

Tip!

When the AW4416 is in the initial state, this will be set to post-fader.

2. To switch a specific channel between pre-fader (PRE) and post-fader (POST), move the cursor to the button for that channel and press the [ENTER] key.



Tip!

To switch all monitor channels between pre-fader/post-fader, move the cursor to the PRE/POST button in the GBL (global) section at the right of the display, and press the [ENTER] key.

□ Adjusting the send level/return level

Here's how to adjust the send level for each monitor channel, and the return level of the return channel.

1. Press the [HOME] key → [17-24 RTN] key.

[SEL] keys 15/16, [ON] keys 15/16, and faders 15/16 will be assigned to return channels 1/2. At this time, faders 15/16 will adjust the input level of the return signals from effects 1/2.



When the AW4416 is in the initial state, the faders of return channels 1/2 will be set to nominal level (0 dB).

2. Press the [VIEW] key → [SEL] key 15.

The VIEW screen of return channel 1 will appear in the display.

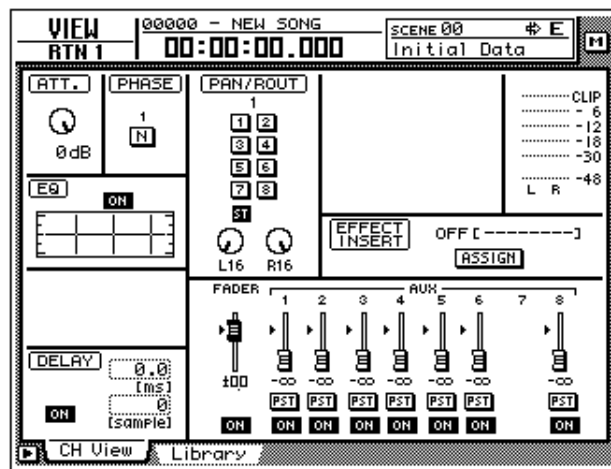

3. Make sure that the ST button of the PAN/ROUT area is on.

In this state, the return signal from effect 1 will be sent to the stereo bus and mixed with the signals of the monitor channels.



If the ST button is off, move the cursor to the button and press the [ENTER] key.

□ Adjusting the send level

1. Press the [AUX 7] key → [MONI] key.

[SEL] keys 1–16, [ON] keys 1–16, and faders 1–16 will be assigned to monitor channels 1–16. At this time, faders 1–16 will adjust the send level of the signals sent from monitor channels 1–16 to AUX 7 (effect 1).

2. While the song plays back, use faders 1–16 to adjust the send level of each monitor channel.
3. As necessary, press the [HOME] key → [17-24] RTN key, and use fader 15 to readjust the return level.

Inserting an effect into a desired channel

If you defeat their assignment to AUX 7/8, the AW4416's internal effects can be inserted into a desired channel. As an example, here's how effect 2 can be inserted into monitor channel 1.

□ Patching

Here's how to release effect 2 from its assignment to AUX send 8, and use it as an insertion effect.

1. Press the [SETUP] key → [F1] (Patch IN) key.
The SETUP screen Patch IN page will appear in the display.

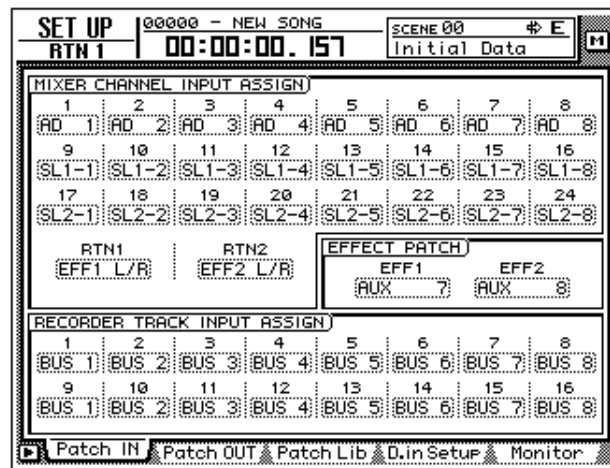

If the Patch IN tab is not assigned to the [F1] key, press the [SHIFT] key + [F1] key to switch the tab, and then press the [F1] key.

2. Move the cursor to the EFF2 parameter of the EFFECT PATCH area, and rotate the [DATA/JOG] dial.
A popup window will appear, asking you to confirm that you wish to disconnect effect 2 from AUX bus 8 and use it for insertion.



3. Move the cursor to the OK button and press the [ENTER] key.
In the EFFECT PATCH area, EFF2 will change to "INSERT." Now the effect can be inserted into the desired channel.



.....
 An effect that has been specified for insertion cannot again be used via AUX send/return until you reassign it to the AUX bus in the EFFECT PATCH area.



.....
 If RTN 2 is set to "EFF 2 L/R" in the Patch IN page, performing this step will automatically cancel the assignment.

□ Inserting an effect into monitor channel 1

1. Press [MONI] key → [SEL] key 1.
 Monitor channel 1 will be selected.
2. Press the [VIEW] key → [F1] key.
 The VIEW screen CH View page will appear in the display.

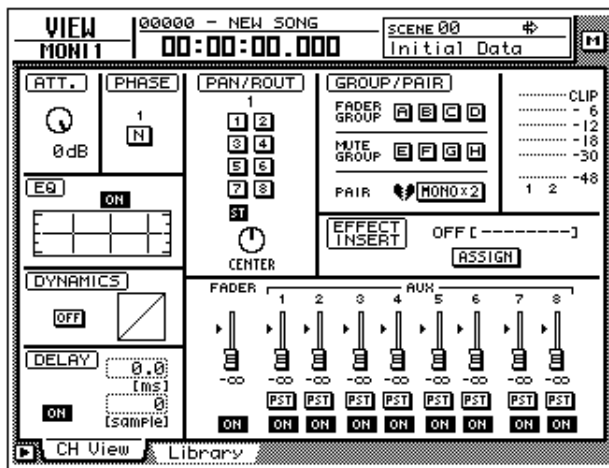

3. Move the cursor to the ASSIGN button in the EFFECT INSERT area, and press the [ENTER] key.
 The EFF.INSERT SETTING popup window will appear. In this popup window, you can use the following four buttons to select the type of effect that will be inserted.

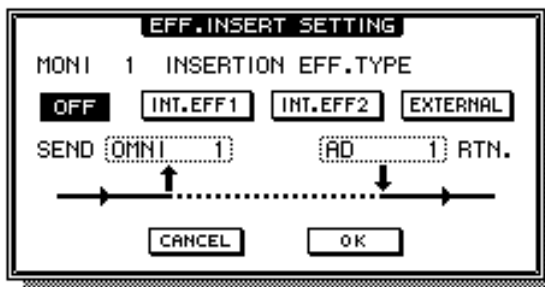

- **OFF**Effect insertion will be cancelled.
- **INT.EFF1**Insert internal effect 1.
- **INT.EFF2**Insert internal effect 2.
- **EXTERNAL**Insert an external effect.



.....
 The INT.EFF1 and INT.EFF2 buttons cannot be turned on if the respective internal effect 1/2 has not been disconnected from AUX send.

4. To insert effect 2, move the cursor to the INT.EFF2 button and press the [ENTER] key.

In the popup window, SEND will change to “EFF2,” and RTN. will change to “EFF 2L.” This indicates that the input of effect 2 has been patched to the insert send of monitor channel 1, and the L output of effect 2 has been patched to the insert return.

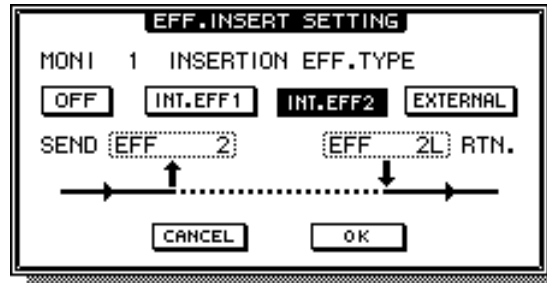

- Regardless of the channel, the effect will be inserted at a position immediately after the attenuator.
- If you move the cursor to the RTN. field and rotate the [DATA/JOG] dial, you can switch between “EFF 2L” and “EFF 2R.”
- If an effect is inserted into a stereo channel (return channels 1/2, stereo output channel), the L/R outputs of the effect will be returned to the L/R of that channel.

5. When you have finished making settings in the EFF.INSERT SETTING popup window, move the cursor to the OK button and press the [ENTER] key.

The EFFECT INSERT field of the CH View page will be displayed as “ON [INT.EFF2].” This indicates that effect 2 has been inserted into the corresponding channel (in this case, monitor channel 1).



An effect that has been inserted into a channel will be usable only for that channel until you insert the same effect into a different channel or turn on the OFF button in the EFF.INSERT SETTING popup window.

□ Recalling an effect program

Here's how you can recall the desired program for effect 2 from the effect library.

1. Press the [AUX 8] key → [F2] key.

The AUX8/EFF2 screen Library page will appear in the display.

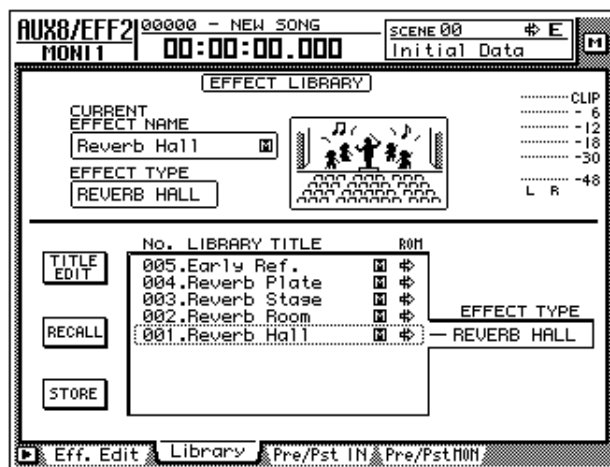

2. Move the cursor to the list at the bottom of the display, and use the [DATA/JOG] dial to select the effect program that you wish to recall.
3. Move the cursor to the RECALL button, and press the [ENTER] key. The selected program will be recalled to effect 2.
4. Press the [F1] key. The Eff.Edit page will appear.

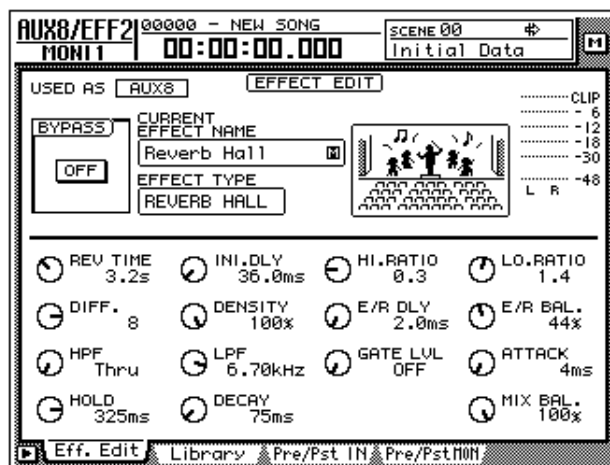

5. As necessary, move the cursor to the MIX BAL. knob and rotate the [DATA/JOG] dial to adjust the balance between the “wet” (processed) and “dry” (unprocessed) sound.



Tip!

Immediately after an effect program is recalled, MIX BAL. will be reset to 100% (only “wet” sound).

11 Song management

This chapter explains song management operations such as saving, loading, deleting, or copying songs.

About songs

On the AW4416, all the data necessary to reproduce a musical composition you create (i.e., mixer settings, recorder settings, audio data, etc.) is saved in the internal hard disk as a “song.” By loading a song into internal memory, you can return to the saved state at any time. A song includes the following data.

- Audio data for all virtual tracks
- TRACK screen settings (including locate point settings)
- Tempo map settings
- Scene memories
- Automix memory
- Patch library
- EQ library
- Dynamics library
- Channel library
- Data and settings for the Sampling Pad function
- Song name and comment
- Counter display method (SECOND/TIME CODE/MEASURE)
- Song Protect setting
- Time Code Top setting
- Region Fade Time setting
- Undo data



Tip!

- *Multiple songs can be saved on the internal hard disk. However, only the single song currently being controlled on the AW4416 (the “current song”) can be handled at any given time.*
- *When the power of the AW4416 is turned on, the most-recently saved song will be loaded automatically.*



Be aware that if you turn off the power of the AW4416 without saving the current song, any changes in the current song will be lost. When you wish to turn off the power of the AW4416, you must perform the shut-down procedure (→ P.17).

Song structure and size

Song structure

The following diagram shows the structure of songs saved on the hard disk. As you can see from the diagram, each song consists of the following two areas.

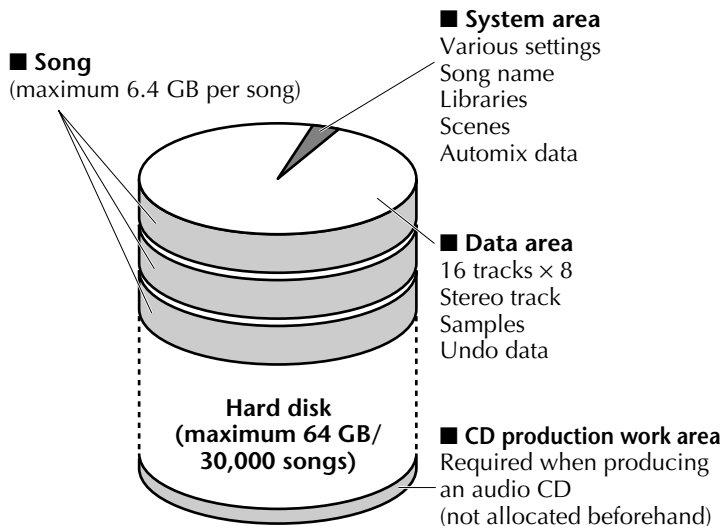

○ System area

This area contains data for various settings, the song name, libraries, scenes, and automix data. The size of the system area is fixed at approximately 2 MB.

○ Audio area

This area contains audio data for the audio tracks and stereo track, sample data, and undo data. The size of the audio area will depend on the size of the recorded tracks and virtual tracks. You can increase the available free area by deleting the audio data of unneeded tracks and then executing the Song Optimize operation.

Usable hard disks/song capacity

The AW4416 can use a hard disk of up to 64 GB, and allows you to create a maximum of 30,000 songs. However, the size of each song (system area + data area) is limited to a maximum of 6.4 GB.



- If you have used up the available space of a song or of the hard disk, you can delete the audio data of unwanted tracks or virtual tracks (→ P.156), and execute the Song Optimize operation (→ P.182) to create more free space. (It is not possible to increase the free space by performing other operations.)
- The song size (SIZE) displayed in the song list shows only the size of the data area. Be aware that in actuality, each song also uses a system area of approximately 2 MB. On the AW4416, data sizes are displayed as 1 KB= 1,024 bytes.

Work area for audio CD production

When using an internal/external CD-R/RW drive to create an audio CD, you will need at least as much work area on the hard disk as occupied by the audio data being written to the CD. For example in order to create a 74 minute audio CD, the internal hard disk must have sufficient free area to record a 74 minute or longer 16 bit/44.1 kHz stereo track (approximately 650 MB).

To check the amount of free area on the internal hard disk, select a 16 bit/44.1 kHz song, and press the REC TRACK SELECT [ST] key to put the stereo track

in record-ready mode. Then access the TRACK screen Stereo page ([TRACK] key → [F3] (Stereo) key), and hold down the [SHIFT] key and press the [F1] (REMAIN) key. The counter will show the REMAIN TIME (remaining time). For example if you wish to create a 74 minute CD, make sure that the remaining time is at least 74 minutes.



If there is not enough free area on the hard disk, you must delete audio data for unneeded tracks or virtual tracks (→ P.156), and then execute the Song Optimize operation (→ P.182) to increase the free area. (It is not possible to increase the free area by performing any other operation.)

Saving/loading a song

Here's how to save the current song on the internal hard disk, and how to load a song from the internal hard disk into the current song.

□ Saving the current song

1. Press the [SONG] key → [F1] key.

The SONG screen Song List page will appear in the display. A list of information on the songs currently saved on the internal hard disk will appear in the upper part of the display. The current song will be highlighted in the list.

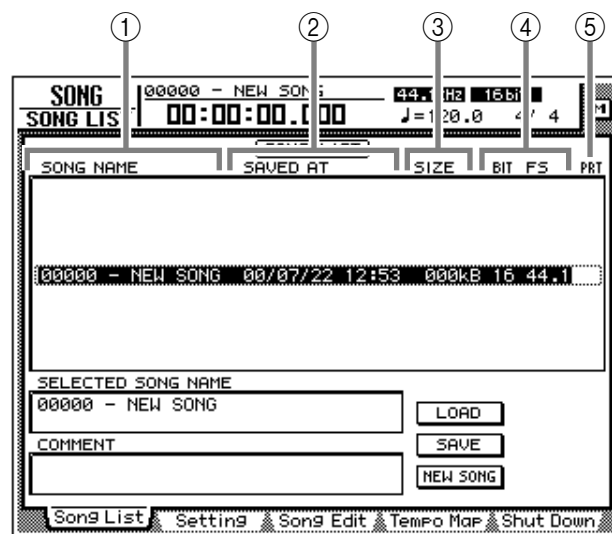

- ① Song name
- ② Date and time when the song was saved
- ③ Song size
- ④ Song quantization/sampling frequency
- ⑤ Song protect

2. To save the current song, move the cursor to the SAVE button in the lower right of the screen and press the [ENTER] key.

A popup window will appear, asking you to confirm that you wish to save the current song.

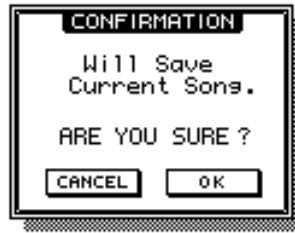

3. To execute the Save operation, move the cursor to the OK button and press the [ENTER] key.



Tip!

- If you decide to cancel without saving, move the cursor to the CANCEL button and press the [ENTER] key.
- If the free space on the internal hard disk is running low, execute the Song Optimize operation (→ P.182). You can also back up desired songs on an external device such as CD-RW or MO (→ P.246).

□ Loading a song

1. Press the [SONG] key → [F1] key.
The SONG screen Song List page will appear.
2. Use the [DATA/JOG] dial to select the song that you wish to load. Then move the cursor to the LOAD button and press the [ENTER] key.
A popup window will appear, asking you whether you wish to save the current song first.

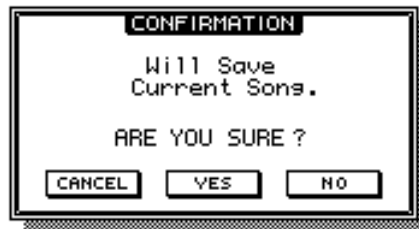

3. If you wish to save the current song before loading another song, move the cursor to the YES button. If you wish to load the song without saving the current song, move the cursor to the NO button. Then press the [ENTER] key.

If you selected the YES button, the current song will be saved and then the selected song will be loaded immediately. If you selected the NO button, any changes to the current song will be discarded, and the selected song will be loaded.



Tip!

- If you decide to cancel the Load operation, move the cursor to the CANCEL button and press the [ENTER] key.

Editing the song name/comment

When you create a new song, a default song name “xxxx - NEW SONG -” (xxxxxx will be a serial number) will be assigned unless you specify otherwise, and the comment will be “No Description”. You can edit the song name and comment afterward.

1. Press the [SONG] key → [F2] key.
The SONG screen Setting page will appear.

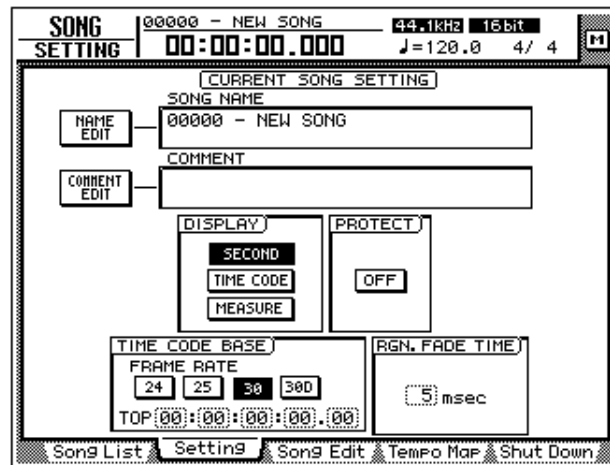

The SONG NAME field in the upper part of the screen will show the song name of the current song, and the COMMENT field will show the comment. (If no comment has been assigned, this will be displayed as “No Description.”)

2. To edit the song name, move the cursor to the NAME EDIT button in the upper left of the screen, and press the [ENTER] key.
The NAME EDIT window will appear, allowing you to assign a name to the song.
3. Use the character palette to modify the name. Then move the cursor to the OK button and press the [ENTER] key. (For details on inputting characters, refer to page 60.)
You will return to the SONG screen Setting page.
4. To edit the comment, move the cursor to the COMMENT EDIT button in the upper left of the screen, and press the [ENTER] key.
The COMMENT EDIT window will appear, allowing you to assign a comment to the song.
5. Use the character palette to modify the comment. Then move the cursor to the OK button and press the [ENTER] key. (For details on inputting characters, refer to page 60.)
You will return to the SONG screen Setting page.



Simply modifying the song name in this page will not change the song name shown in the list of the SONG screen Song List page. The new name will be reflected in the list when you save the current song.

Deleting/copying a song

Here's how to delete a song saved on the internal hard disk, or copy (duplicate) a song within the hard disk.

□ Deleting a song

1. Press the [SONG] key → [F3] key.

The SONG screen Song Edit page will appear in the display. The upper part of the display will show a list of the songs currently saved on the hard disk. The current song will be highlighted in the list. The song currently selected for editing will be indicated by an "E" symbol at the left of the list.



.....
Songs you delete will be lost forever. Use this procedure with caution.



.....
When you delete, copy, or optimize a song, the current song will be saved automatically.

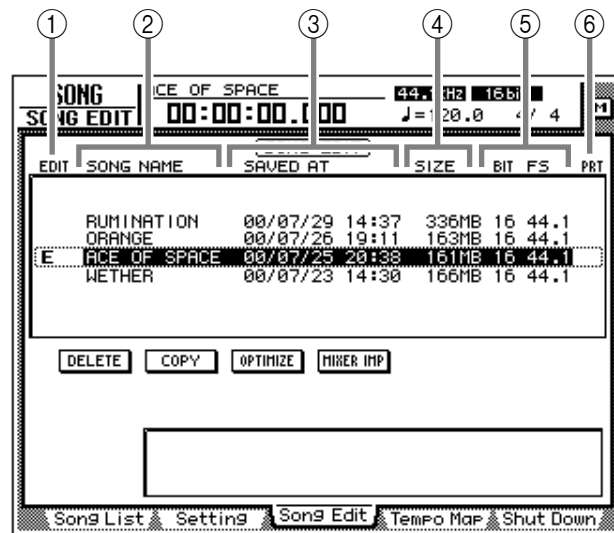

- ① The song currently selected for editing
- ② Song name
- ③ Date and time when the song was saved
- ④ Song size
- ⑤ Song quantization/sampling frequency
- ⑥ Song protect



.....
It is not possible to delete a protected song. You must load the song, and turn off the PROTECT button in the SONG screen Setting page before performing the Delete operation.

2. Move the cursor to the list in the upper part of the display, use the [DATA/JOG] dial to select the song that you wish to delete, and press the [ENTER] key.

An “E” symbol will appear at the left within the list, indicating that the corresponding song is selected for deletion.

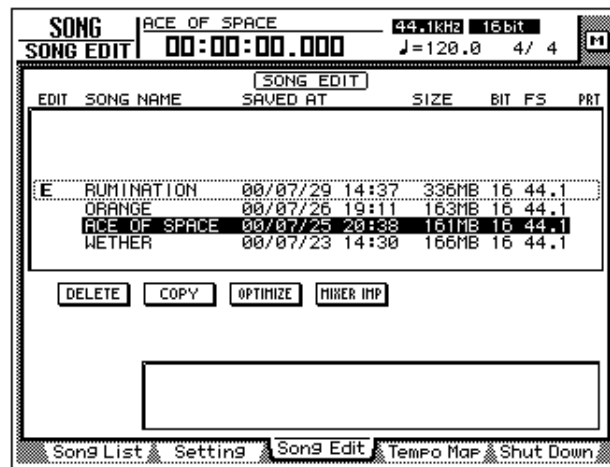

Tip!

- If you select a song that is already marked with an “E” and press the [ENTER] key, the “E” symbol will disappear, and the song will be excluded from the Delete operation.
- You can select multiple songs for deletion.



Warning!

It is not possible to delete the current song. If you execute Song Delete with an “E” symbol displayed for the current song, an error message will appear. Load a different song to change the current song. Then execute the operation.

3. Move the cursor to the DELETE button and press the [ENTER] key. A popup window will appear, asking you to confirm the Delete operation.
4. To execute the Delete operation, move the cursor to the OK button and press the [ENTER] key. The current song will automatically be saved, and the specified song(s) will be deleted.



Tip!

If you wish to cancel without deleting, move the cursor to the CANCEL button and press the [ENTER] key.

□ Copying a song

1. Press the [SONG] key → [F3] key to access the SONG screen Song Edit page.
2. Move the cursor to the list in the upper part of the display. Use the [DATA/JOG] dial to select the song that you wish to copy, and press the [ENTER] key.

An “E” symbol will appear in the left edge of the list, indicating that the corresponding song is selected for the Copy operation.



You may select multiple songs (including the current song) for copying.

3. Move the cursor to the COPY button, and press the [ENTER] key. A popup window will ask you to confirm the Copy operation.



- If you decide to cancel the Copy operation, move the cursor to the CANCEL button and press the [ENTER] key.
- After the Copy operation is executed, the hard disk will contain two songs with identical song name, date, and size. To avoid confusion, we recommend that you change the song name immediately.

4. To execute the Copy operation, move the cursor to the OK button and press the [ENTER] key. The current song will be saved automatically, and then the Copy operation will be executed.

Optimizing a song

By using the top panel [UNDO] key and [REDO] key, you can cancel or re-execute the last-performed recording or track editing operation. By repeatedly pressing the [UNDO] key, you can retrace as many as 15 previous operations. Undo/redo can be a very convenient function, but when you record or perform a track editing operation, data for the corresponding number of Undo operations must be maintained, and this data will occupy space on the hard disk.

The “Optimize” command deletes any audio data that is not currently being used by the song; i.e., it deletes the Undo data. In order to recover this space, we recommend that you execute the Song Optimize command when you are finished recording and editing.

1. Press the [SONG] key → [F3] key.

The SONG screen Song Edit page will appear in the display. The upper part of the display will show a list of the songs currently saved on the hard disk.

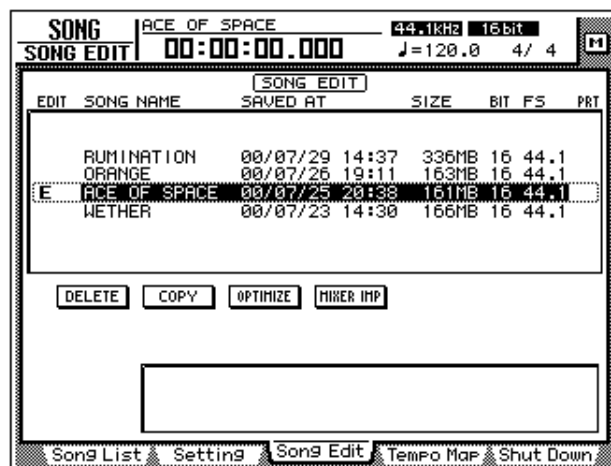

2. Move the cursor to the list in the upper part of the display, use the [DATA/JOG] dial to select the song that you wish to optimize, and press the [ENTER] key.

An “E” symbol will appear in the left edge of the list, and the corresponding song will be selected optimization.



.....
It is not possible to execute Optimize with more than one song selected. If Optimize is executed when the “E” symbol is displayed for more than one song, an error message will be displayed.

3. Move the cursor to the OPTIMIZE button, and press the [ENTER] key. A popup window will ask you to confirm the Optimize command.
4. To execute the Optimize command, move the cursor to the OK button and press the [ENTER] key.
The current song will be saved automatically, and then the Optimize command will be executed.



.....
If you decide to cancel the Optimize command without executing, move the cursor to the CANCEL button and press the [ENTER] key.

Importing mixer data of an existing song

You can extract the scene memory, automix, tempo map, and library data (referred to as “mixer data”) of a previously-saved song, and import it into the current song. For example, this function is convenient when an existing song has a special effect library that you wish to use in a newly created song.



- Be aware that when you execute the mixer data import command, the corresponding mixer data of the import destination song (the current song) will be erased, and replaced by the imported mixer data.
- Library mixer data includes all libraries: channel, EQ, dynamics, and effect.

1. If necessary, load the import destination song as the current song.
2. Press the [SONG] key → [F3] key.

The SONG screen Song Edit page will appear in the display. The upper part of the display will show a list of the songs currently saved in the hard disk. The current song will be highlighted in the list.

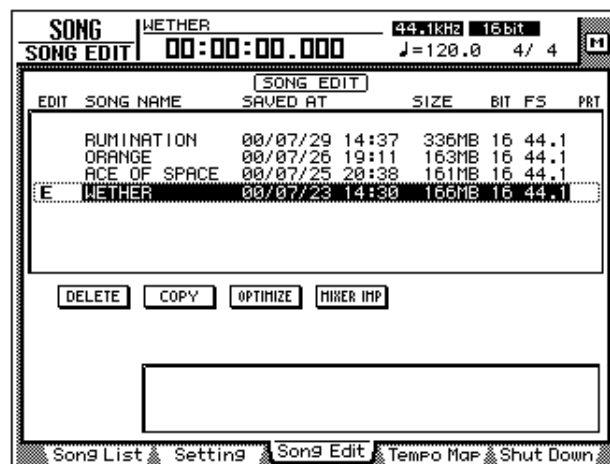

3. Move the cursor to the list in the upper part of the display, and use the [DATA/JOG] dial to select the import source song from which you wish to import mixer data.
4. Press the [ENTER] key.
An “E” symbol will appear at the left edge of the list, and the corresponding song will be selected as the import source for mixer data.



- *The current song cannot be selected as the import source. If you execute Import when the current song is marked with an “E” symbol, an error message will be displayed.*
- *It is not possible to select two or more songs as the import source.*

5. Move the cursor to the MIXER IMP button and press the [ENTER] key.
The MIXER DATA IMPORT popup window will appear.



6. Turn on the button(s) for the type(s) of mixer data that you wish to import. (You may select more than one.)
 - **SCENE MEM. button**Scene memories
 - **AUTOMIX button**Automix
 - **TEMPO MAP button**Tempo map
 - **LIBRARY button**Libraries (channel/EQ/dynamics/effect)
7. To execute the Import, move the cursor to the OK button and press the [ENTER] key.



If you decide to cancel the Import command without executing, move the cursor to the CANCEL button and press the [ENTER] key.

12 Sampling pads

This chapter explains the sampling pads of the AW4416.

About the sampling pads

The AW4416 has a sampling pad function that allows you to play samples by striking pads. By striking the eight pads in the SAMPLING PAD section you can play up to sixteen samples held in RAM, and record your playing on a simple sequencer that is linked with the recorder.

A sample can be assigned to a pad on one of three ways. You can directly assign a region (a piece of continuous audio data that was recorded in a single operation) that was recorded earlier on a track, import CD-DA data from an audio CD, or import a WAV file from a CD-ROM or MO disk.

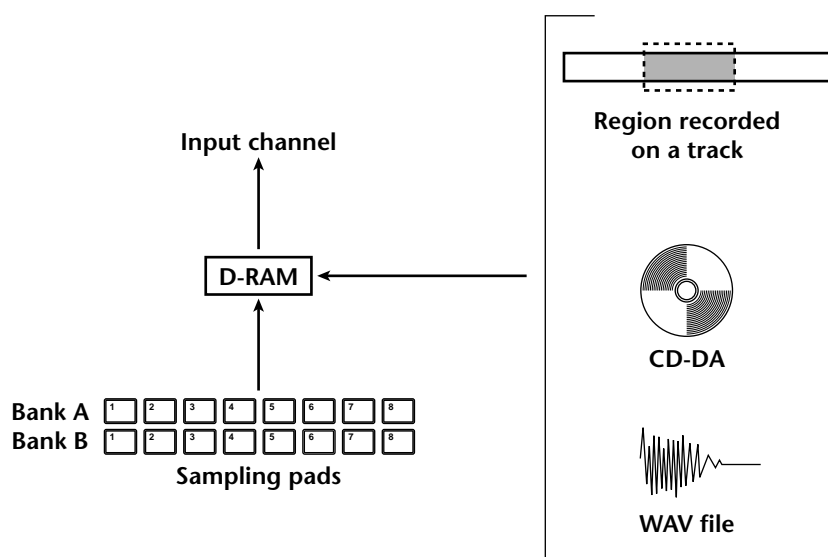

Tip!

- The eight sampling pads can be used as sixteen pads by switching between two banks A and B.
- Sampling pad settings and the samples in RAM are saved as part of the song.



The samples that can be assigned to the pads must be the same audio format as that song. For example in the case of a song that was created as 24 bit/48 kHz, CD-DA (16 bit/44.1 kHz) data cannot be imported. In the case of a 16 bit/44.1 kHz song, 16 bit/48 kHz WAV files cannot be imported.

Assigning the pad outputs to channels

In order to use the sampling pads, you must first assign each pad output to an input channel 1–24. The output of a pad that is assigned to a channel can be controlled by attenuation, phase, EQ, and dynamics in the same way as a conventional input, and can be recorded on a track of the recorder.

1. Press the [SETUP] key → [F1] key.

The SETUP screen Patch In page will appear, allowing you to select the input signal for each input channel.

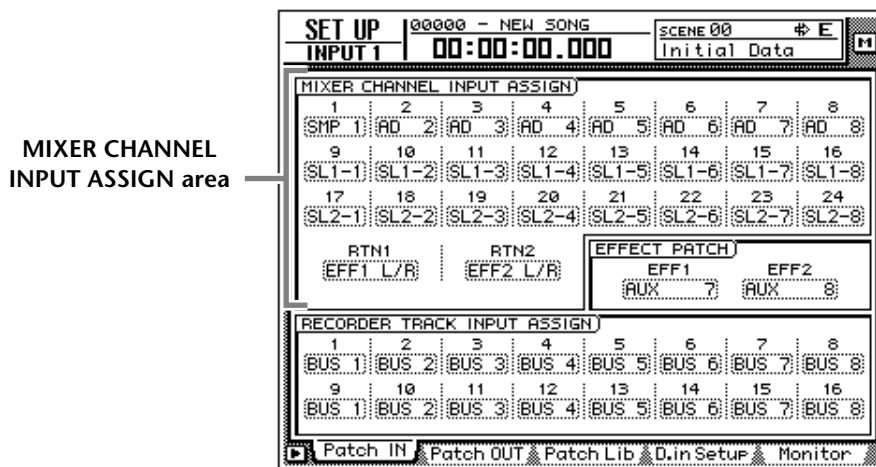

2. In the MIXER CHANNEL INPUT ASSIGN area, move the cursor to the input channel to which you will assign the pad output.
3. Rotate the [DATA/JOG] dial to make a selection in the range of “SMP 1”–“SMP 8.”

The output of the selected pad will be assigned to the input channel.



- Pad assignments are common to banks A and B. If “SMP 1” is selected for a channel, the output of pad 1 for both banks A and B will be assigned to it.
- All sounds assigned to pads will be monaural output.

4. Turn on the [ON] key of the input channel to which the pad is assigned, and raise the fader.

Now the signal of the pad you selected in step 3 will be sent to the corresponding input channel, and can be recorded or monitored.

Assigning a region to a sampling pad

In order to use the pads to play samples, you must first assign the desired samples to those pads. There are three ways to assign samples to pads.

- ① **Assign a desired region from tracks 1–16 of the recorder section**
- ② **Import an audio CD track from an internal/external CD-RW drive**
- ③ **Import a WAV file from a SCSI device**

As an example, here's how to assign a region that was previously recorded on a track.

1. In the SAMPLING PAD section, press the [EDIT] pad → [F1] key.

The SAMP.PAD screen From Rgn. page will appear, allowing you to assign a desired region to a pad. This page shows three buttons and the regions recorded on each track.

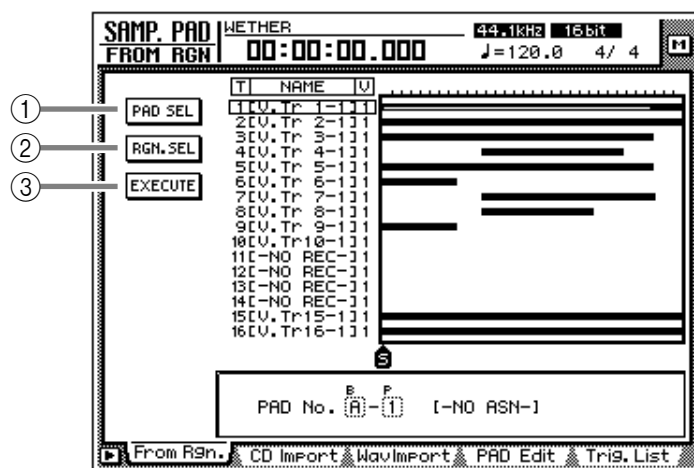

The three buttons have the following functions.

- ① **PAD SEL button**
Selects the pad to which the region will be assigned.
- ② **RGN. SEL button**
Selects the region.
- ③ **EXECUTE button**
Executes the assignment of the region to the pad.

2. Move the cursor to the PAD SEL button in the upper left of the display, and press the [ENTER] key.

The cursor will move to the PAD No. area in the lower right of the display. Pads to which nothing is assigned will be displayed as “-NO ASN-”.

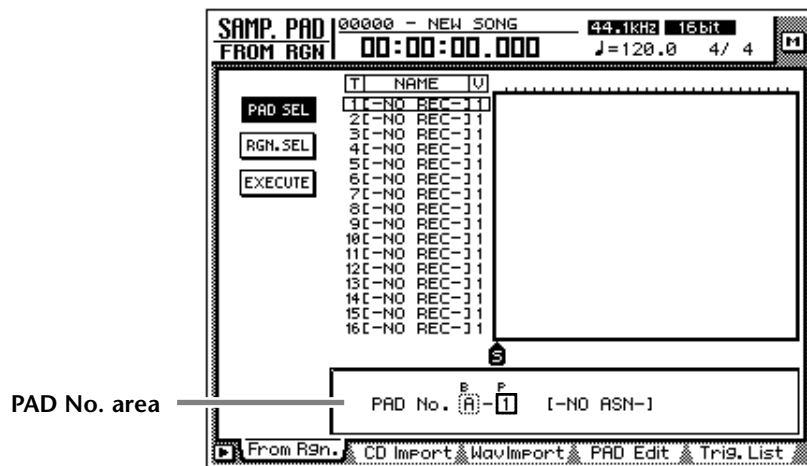

3. Use the [CURSOR] keys and the [DATA/JOG] dial to select the pad bank (A/B) and pad number (1–8) to which a region will be assigned.
4. Press the [ENTER] key.
The cursor will return to the PAD SEL button.
5. Move the cursor to the RGN. SEL button and press the [ENTER] key.
The currently selected region will blink.



.....
If you perform this step when no region exists (i.e., when nothing has been recorded on any track), an message of “ERROR SELECTED SONG HAS NO REGION” will appear, and it will not be possible to make settings.

6. Use the [CURSOR] keys to move the cursor to select the region.
The currently selected region will be highlighted, and its size will be displayed at the bottom of the screen.



.....
The sample size that can be assigned to the sampling pads are limited to a total of approximately 8 MB (approximately 90 seconds at 16 bit/44.1 kHz). If you wish to assign only a portion of a long region to a pad, you should first use the EDIT screen TR Edit page to divide the region (→ P.156).

7. Press the [ENTER] key.
The selected region will be highlighted, and the cursor will return to the RGN. SEL button.

8. Move the cursor to the EXECUTE button, and press the [ENTER] key. A popup window will appear, asking you to confirm the assignment to the pad.



9. To execute the assignment, move the cursor to the OK button and press the [ENTER] key.

When the assignment is completed, the display will indicate “COMPLETE.”



Tip!

When you assign a region to a pad, a name of “Smpltr” will automatically be assigned to that pad. If you wish to change this name, refer to page 193.



Tip!

For the procedure of importing CD-DA data or a WAV file to a pad, refer to the Reference Guide.



Warning!

If you attempt to assign a sample that would exceed the memory capacity, an error message of “Memory Full” will be displayed, and the assignment will not be executed.



Tip!

You can check the approximate amount of sample pad memory in the SMPL. PAD screen PAD Edit page ([EDIT] pad → [F4] key).

Trimming a sample

You can make fine adjustments to the playback start location and playback end location of a sample assigned to a pad in order to eliminate unwanted portions at the beginning and end.

Use the TRIM IN command to adjust the playback start location, and use the TRIM OUT command to adjust the playback end location.



Trimming a sample will not increase the sample size that can be assigned to the sampling pads.

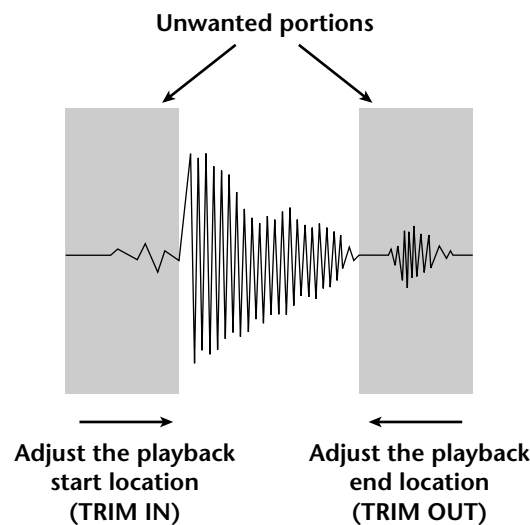

1. In the SAMPLING PAD section, press the [EDIT] pad → [F4]. The PAD Edit page will appear.

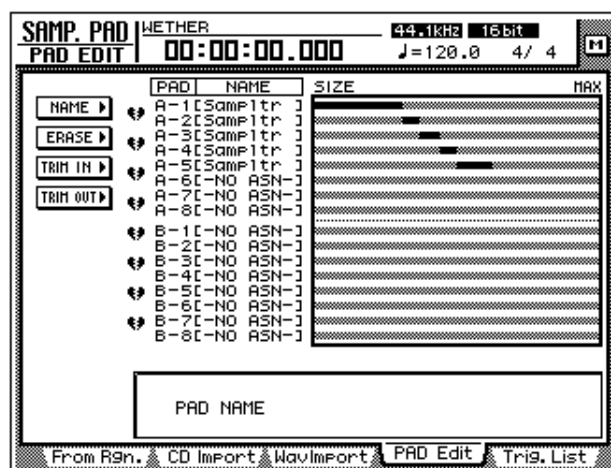

2. Move the cursor to the TRIM IN menu (if you wish to edit the playback start location) or the TRIM OUT menu (if you wish to edit the playback end location), and press the [ENTER] key.

Buttons for setting the TRIM IN/TRIM OUT command parameters will appear.

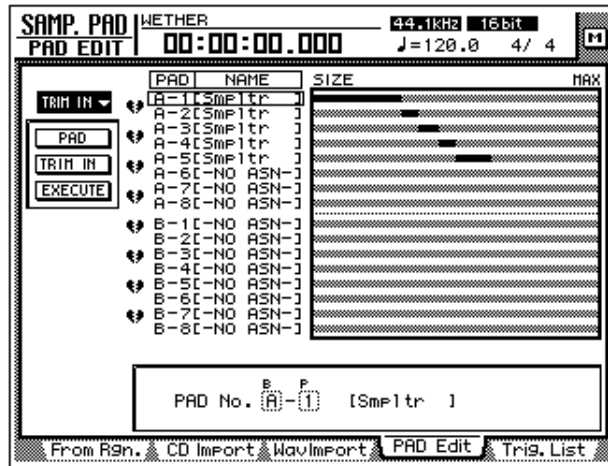

3. Move the cursor to the PAD button, and press the [ENTER] key.
The cursor will move to the PAD No. area in the lower right.
4. Use the [CURSOR] keys and the [DATA/JOG] dial to select the pad bank and pad number that you wish to trim.
5. Press the [ENTER] key.
The cursor will return to the PAD button.
6. Move the cursor to the TRIM IN button (if editing the playback start location) or the TRIM OUT button (if editing the playback end location), and press the [ENTER] key.
The cursor will move to the trim value field.

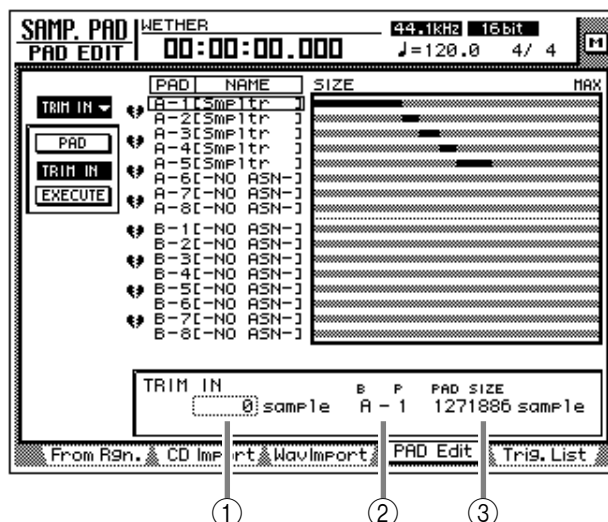

① **TRIM IN/TRIM OUT**

Here you can specify the amount of trimming in units of a sample.

② **Bank/pad number**

This displays the bank and pad number of the currently selected pad.

③ **PAD SIZE**

This displays the length of the currently assigned sample, in units of one sample.

7. Use the [DATA/JOG] dial to specify the amount of trimming in sample units.
8. Press the [ENTER] key.
9. Move the cursor to the EXECUTE button, and press the [ENTER] key.
A popup window will appear, asking you to confirm the trimming operation.

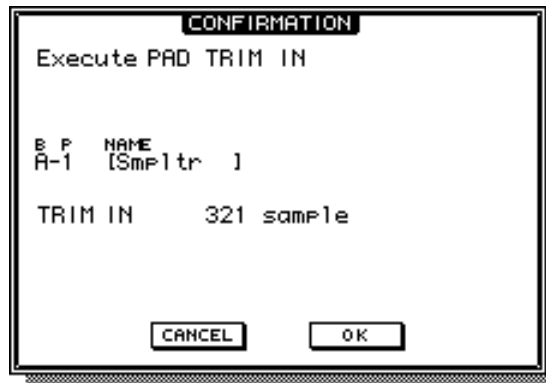

10. To execute the trimming operation, move the cursor to the OK button and press the [ENTER] key.
The beginning or end of the sample will be deleted as you specified. Strike the pad to hear the results.



.....
Once you execute the trimming operation, it cannot be reversed by pressing the [UNDO] key. If you wish to make fine adjustments again, you must re-assign the region.

Naming a pad

You can name each pad to which a sample is assigned.

1. In the SAMPLING PAD section, press the [EDIT] pad → [F4] key.
The PAD Edit page will appear.

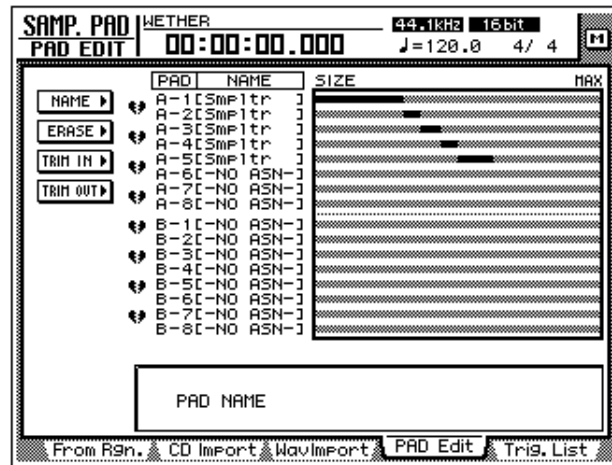

2. Move the cursor to the NAME menu and press the [ENTER] key.
The display will show the PAD button used to select a pad, and the NAME button used to assign a name.

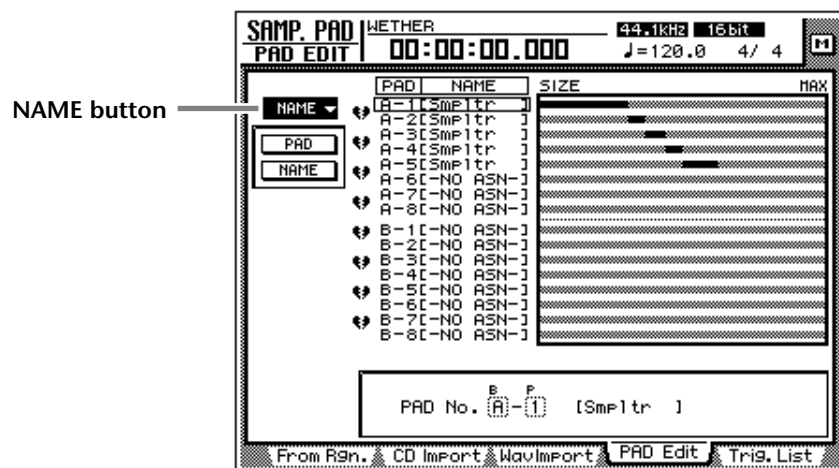

3. Move the cursor to the PAD button and press the [ENTER] key.
The cursor will move to the PAD No. area at the lower right.
4. Use the [CURSOR] keys and the [DATA/JOG] dial to select the bank and number of the pad that you wish to name.
5. Press the [ENTER] key.
The cursor will return to the PAD button.

- Move the cursor to the NAME button and press the [ENTER] key. The NAME EDIT popup window will appear, allowing you to input the name.



A name of up to eight characters can be input.

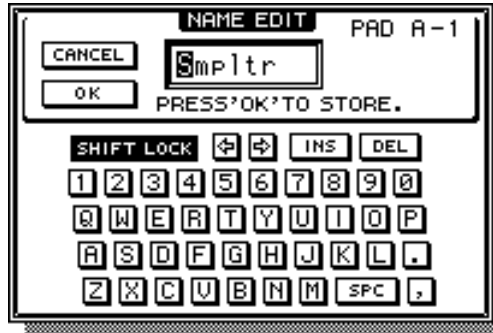

- After assigning the desired name, move the cursor to the OK button and press the [ENTER] key.



For details on inputting characters, refer to page 60.

Erasing a pad sample and name

Here's how to erase the sample and name assigned to a pad, returning that pad to the initial state.

- In the SAMPLING PAD section, press the [EDIT] pad → [F4] key. The SAMP.PAD screen PAD Edit page will appear.

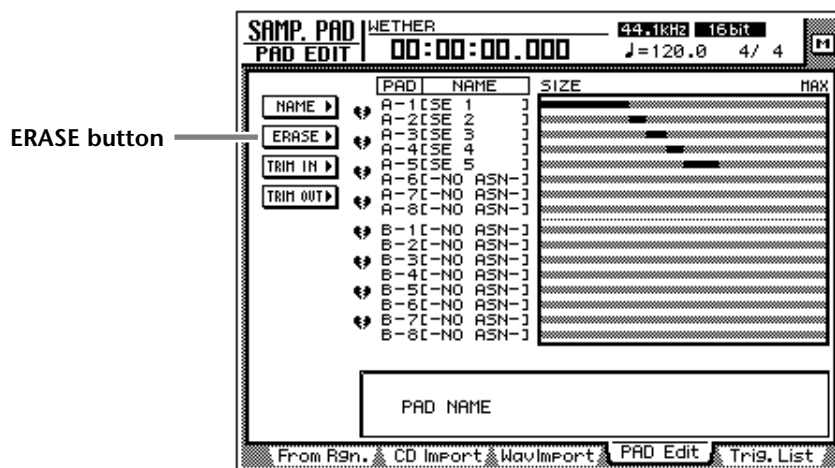

- Move the cursor to the ERASE button and press the [ENTER] key. The display will show the PAD button used to select the pad, and the EXECUTE button used to execute the Erase command.

3. Move the cursor to the PAD button and press the [ENTER] key.
The cursor will move to the PAD No. area at the lower right.
4. Use the [CURSOR] keys and the [DATA/JOG] dial to select the bank and pad number of the pad that you wish to erase.
5. Press the [ENTER] key.
Press the [ENTER] key.
The pad will be selected, and the cursor will return to the PAD button.
6. Move the cursor to the EXECUTE button, and press the [ENTER] key.
A popup window will appear, asking you to confirm that you wish to erase the pad settings.

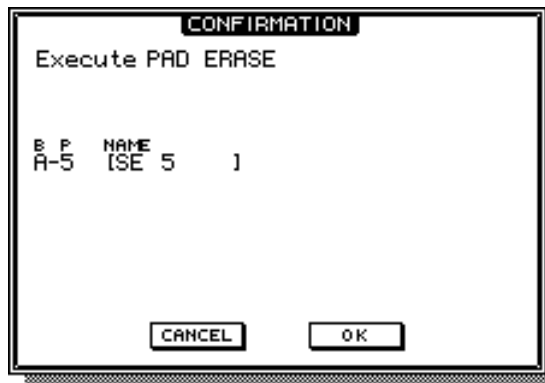

7. To execute the Erase command, move the cursor to the OK button and press the [ENTER] key.

Recording your performance on the sampling pads

The AW4416 provides a simple sequencer dedicated to the sampling pads which operates in conjunction with the recorder. This simple sequencer records the timing of the trigger events that occur when you strike a pad, and can be used to layer kick or snare sounds on the audio tracks, or to add sound effects. Events in a specified area can also be copied repeatedly as a pattern, or erased.

Here's how to record your pad performance on the simple sequencer.

1. In the SAMPLING PAD section, press the [EDIT] pad → [F5] key.
The Trig. List page will appear, allowing you to record your pad performance.

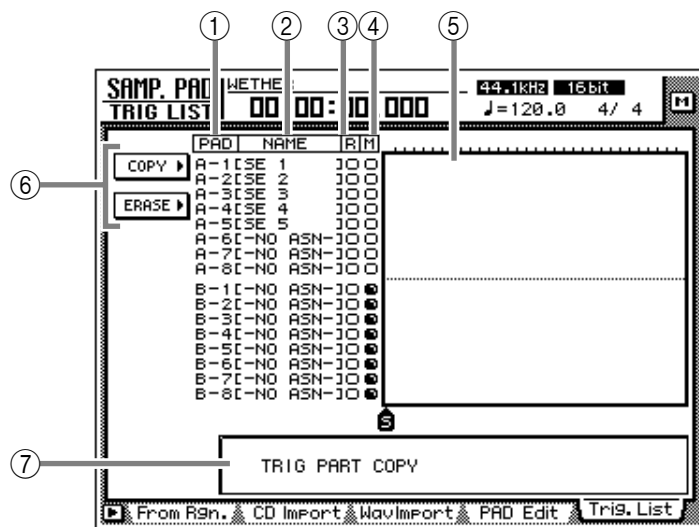

This screen shows the following information.

① **PAD**

The bank and number of the pads that will be recorded/played.

② **NAME (pad name)**

This is the name assigned to each pad. Pads to which no sample has been assigned will be displayed as “-NO ASN-”.

③ **R button**

This is the recording switch for each pad. When you move the cursor and press the [ENTER] key to change the button display from O to ●, that pad can now be recorded.

④ **M button**

This is the mute switch for each pad. When you move the cursor and press the [ENTER] key to change the button display from O to ●, that pad will be muted.



.....
It is not possible to play bank A and B pads simultaneously. The M buttons will automatically switch to ● for the bank that is not currently selected by the [BANK] switch, and will be muted.

⑤ **Pad tracks**

These tracks record the timing of the trigger events for each pad. The time from while you press the pad until you release it is shown as a bar graph.

⑥ **COPY/ERASE menu**

This menu accesses commands for copying/erasing previously-recorded trigger events. Move the cursor to the desired menu and press the [ENTER] key to access the list of commands.

⑦ **Parameter value area**

In this area you can set the parameters required to execute the command.

- Use the [CURSOR] keys and the [ENTER] key to switch the R column of the pad(s) you wish to record from O to ●.

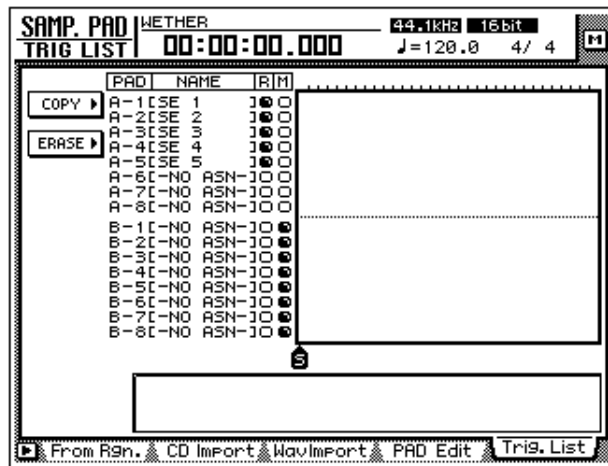

- Start the recorder, and strike the pads while listening to the playback of the audio tracks.

Trigger events will be recorded on the corresponding pad track.

- When you are finished performing, stop playback on the recorder.



Tip!

- You can also begin recording from the middle of the song.
- Immediately after recording, you can press the [UNDO] key to cancel trigger event recording.

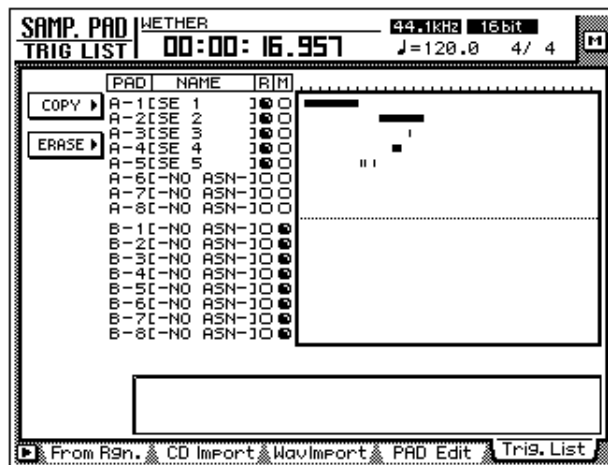

- Use the [CURSOR] keys and the [ENTER] key to change the R column from ● back to O, and play back the recorder to hear the playback of the trigger events.



Be aware that if you play back the recorder when the R column still displays ● and strike the pads, your new performance will be recorded.



If you switch the M column of a pad from O to ●, that pad track will be muted even if you play back the recorder.

Copying a pad performance

Here's how to copy a recorded pad performance to another location.

- In the SAMPLING PAD section, press the [EDIT] pad → [F5] key. The Trig. List page will appear.

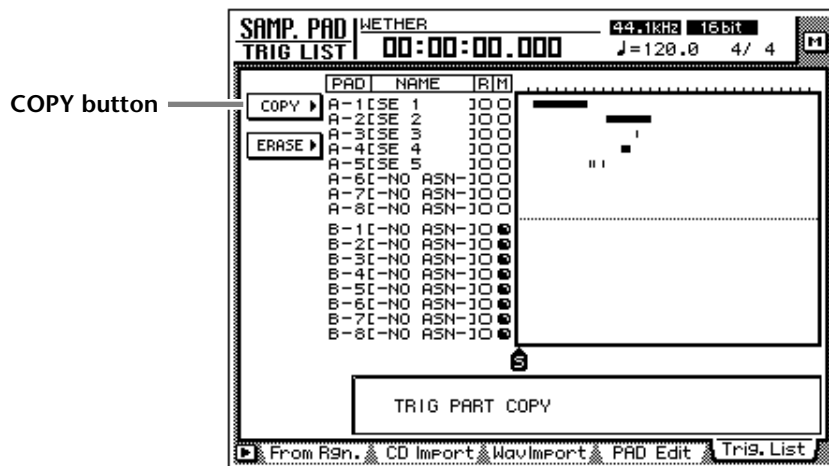

- Move the cursor to the COPY menu and press the [ENTER] key. The parameters for the copy command will appear. These parameters have the following functions.

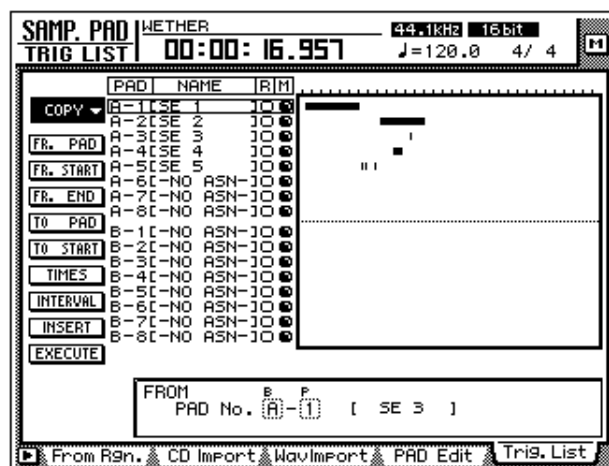

○ **FR. PAD (from pad)**

Specify the copy source pad track.

○ **FR. START (from start)**

○ **FR. END (from end)**

Specify the beginning (FR. START) and end (FR. END) of the area that will be copied from the pad track specified by FR. PAD. The specified area will be selected as a pattern.

○ **TO PAD**

Select the copy destination pad track.

○ **TO START**

Specify the location in the pad track selected by TO PAD at which the data will be copied.

○ **TIMES (copy times)**

Specify the number of times that the data will be copied. The pattern selected as the copy source will be copied repeatedly.

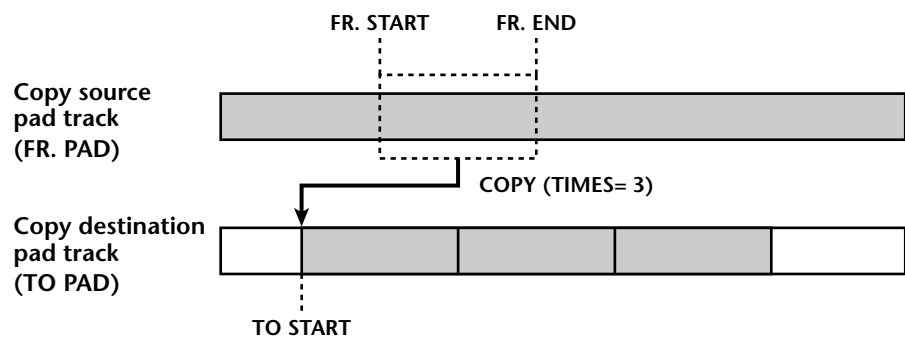

.....

Please note that the above operation does not copy the sample itself, but rather the pad operation. This means that if the copy source and copy destination track are different, a different sample will be played at the copy destination. Even if you specify FR.START or FR.END during pad playback on the copy destination track, the sample will always play back from the beginning for the specified length on the copy destination track.

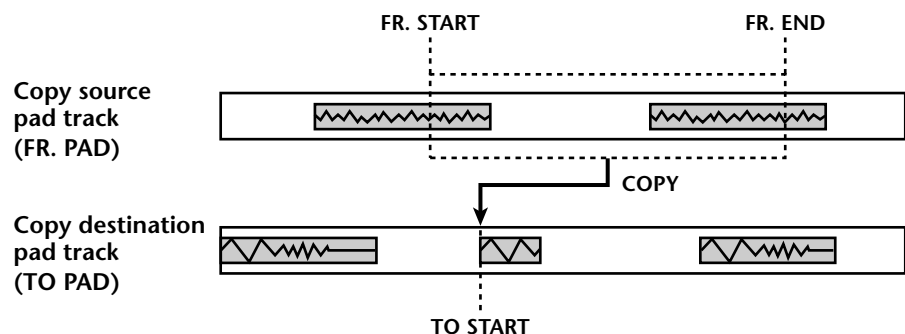

○ INTERVAL

When copying multiple times, this parameter specifies the interval between copy destination patterns.

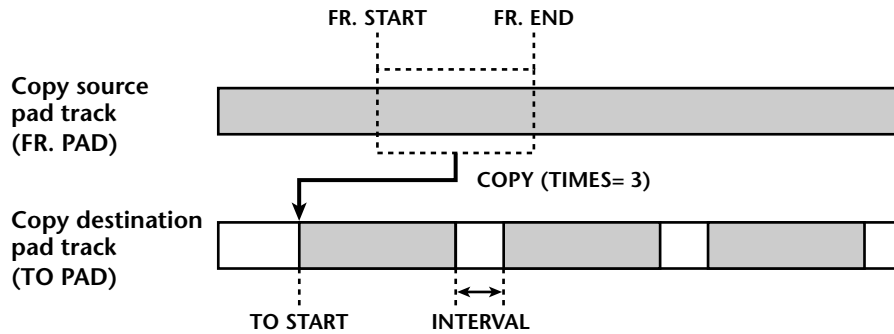

○ INSERT

Specify whether the pattern will be inserted (Insert) or overwritten (OverWrite) at the copy destination.

○ EXECUTE

This button executes the Copy operation.



Tip!

- If you set the counter to measure units, you can set the FR. START, FR. END, and TO START parameters in measure/beat units.
- Instead of using the [DATA/JOG] dial to vary a location continuously, you can use the keys of the locate section to move instantly to a desired locate point or marker.

3. Move the cursor to the parameter whose setting you wish to change, and press the [ENTER] key.
The cursor will move to the parameter setting, and the value of the selected parameter will be displayed.
4. Use the [DATA/JOG] dial to set the parameter, and press the [ENTER] key.
The setting will change, and the cursor will return to the parameter location of step 3.
5. Repeat steps 3–4 to set the remaining parameters.
6. Move the cursor to the EXECUTE button and press the [ENTER] key.
A popup window will appear, asking you to confirm the Copy command.

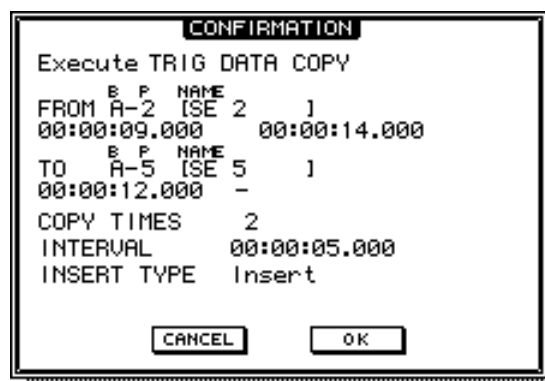

- To execute the Copy, move the cursor to the OK button and press the [ENTER] key.



You can undo the result of the copy by pressing the [UNDO] key immediately after executing Copy.

Erasing a pad performance

Here's how to erase a pad performance that you recorded.

- In the SAMPLING PAD section, press the [EDIT] pad → [F5] key. The Trig. List page will appear.

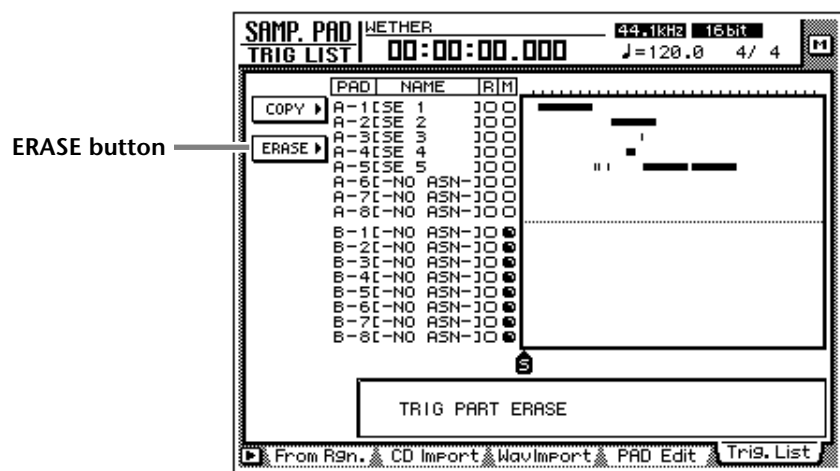

- Move the cursor to the ERASE menu, and press the [ENTER] key.

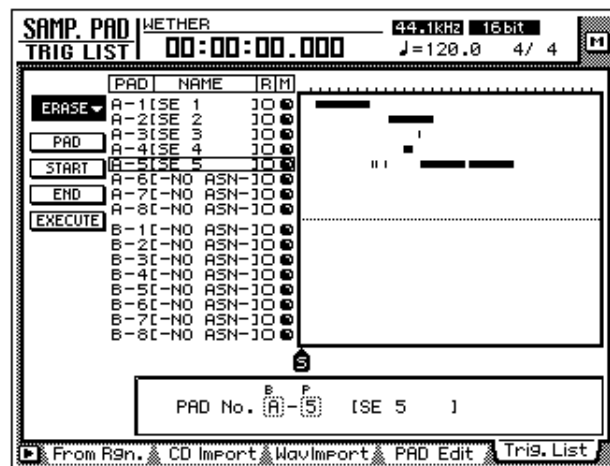

The parameters for the Erase command will appear. Each parameter has the following function.

○ **PAD**

Select the pad track that will be erased.

○ **START**○ **END**

Specify the beginning (START) and end (END) of the area that will be erased from the pad track selected by PAD.

○ **EXECUTE**

This button executes the Erase command.

**Tip!**

- If you set the counter to measure units, you can set the START and END parameters in measure/beat units.
- Instead of using the [DATA/JOG] dial to vary a location continuously, you can use the keys of the locate section to move instantly to a desired locate point or marker.

3. Move the cursor to the parameter whose setting you wish to change, and press the [ENTER] key.

The cursor will move to the parameter setting, and the value of the selected parameter will be displayed.

4. Use the [DATA/JOG] dial to set the parameter, and press the [ENTER] key.

The setting will change, and the cursor will return to the parameter location of step 3.

5. Repeat steps 3–4 to set the remaining parameters.

6. Move the cursor to the EXECUTE button and press the [ENTER] key.

A popup window will appear, asking you to confirm the Erase command.

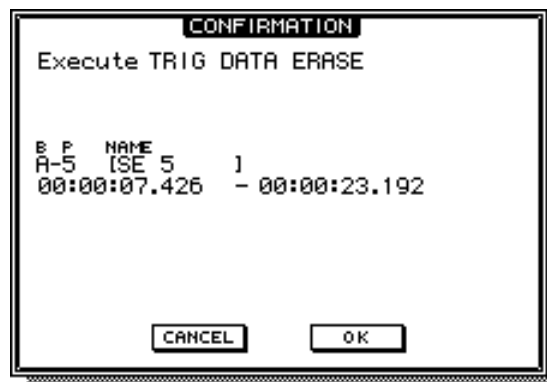

7. To execute the Erase command, move the cursor to the OK button and press the [ENTER] key.

**Tip!**

You can undo the result of the erasure by pressing the [UNDO] key immediately after executing Erase.

13 Scene memory

This chapter explains the scene memory function and how to use it.

About scene memory

On the AW4416, settings such as the mix parameters of each channel, external input/output patching, and effect 1/2 parameters can be assigned a name and stored in internal memory as a “scene.” The memory area in which these scenes are stored is called “scene memory.” Up to 96 scenes can be stored for a single song, and can be recalled by operations of the AW4416’s keys or by the automix function. All scenes stored in scene memory are saved on the hard disk as part of the song.

□ Parameters included in a scene

The following parameters are included in a scene.

Mix parameters	Fader locations for all channels and buses (input channels 1–24, recorder monitor channels 1–16, AUX send levels 1–8, effect returns 1/2, stereo)
	ON key settings of all channels
	Attenuation settings of all channels
	Phrase settings of all channels
	EQ settings of all channels
	Pan settings of all channels
	Routing settings of all channels
	Fader group settings of all channels
	Pair settings of all channels
	Dynamics settings of all channels
	Delay settings of all channels
Effect parameters	Parameter settings of effects 1/2
Other	Scene name settings
	Fader recall fade time settings
	Internal input/output patching and insert settings

□ About scene numbers

There are 97 scene numbers, numbered 00–96. Of these, scenes can be stored in scene numbers 01–96. Scene number 00 contains a scene that returns the parameters to the initial state of the AW4416, and is for recall only.

The currently recalled scene number is displayed at the upper right of the level meter/counter. When a key of the MIXER section, FADER MODE section, AUTOMATION section, or UNIT section (except for the [FILE] key) is pressed, the upper right of the display will show the number and name of the currently recalled scene.

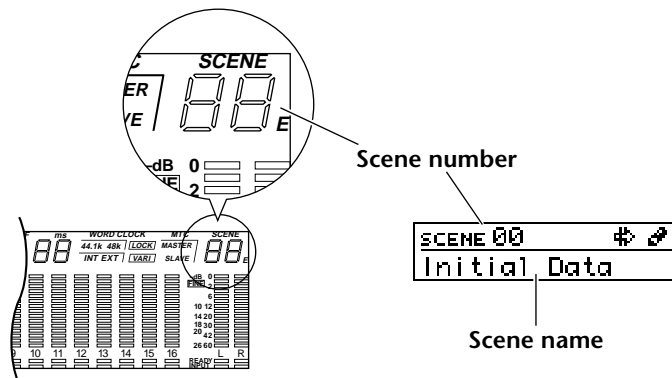

• **Level meter/counter**

• **Display**

If an “E” character is displayed at the right of the scene number, this means that the currently operated scene (the “current scene”) is different than the previously recalled or saved contents.



When the read-only scene number 00 is recalled, a  symbol will appear, indicating that the scene is read-only.

Storing a scene

Here’s how to assign a name to the current scene and store it in a scene memory.

1. Press the [SCENE] key → [F1] key.

The Scene Mem page of the SCENE screen will appear. A list of the scenes (scene numbers and scene names) stored in scene memory will be shown in the center of the display. The last-recalled scene will be highlighted in the list. For scene numbers in which no data has been stored, the scene number field will indicate “[No Data !].”

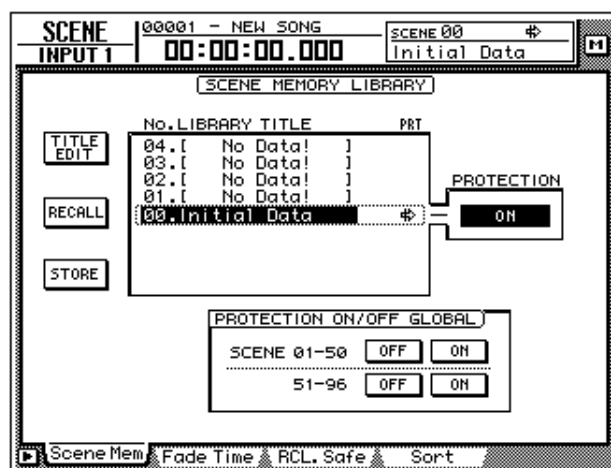

- Use the [DATA/JOG] dial to select the store destination scene number (01–96).

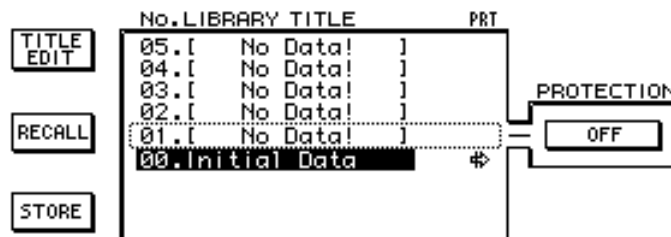

- Scene number 00 is for recall only, and cannot be stored.
- Be aware that if you select a previously-stored scene number and execute the Store operation, the previous scene will be lost.

- Use the CURSOR [◀]/[▶]/[▲]/[▼] keys to move the cursor to the STORE button in the screen, and press the [ENTER] key. The TITLE EDIT popup window will appear, allowing you to specify the name of the scene (scene name).

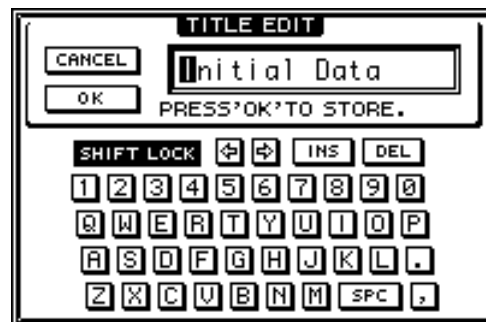

- Use the CURSOR [◀]/[▶]/[▲]/[▼] keys and the [DATA/JOG] dial to specify the name of the scene. For details on inputting characters, refer to page 60.
- To store the scene, move the cursor to the OK button in the screen and press the [ENTER] key. The scene will be stored, and the AW4416 will be in the same state as when the store destination scene number of step 2 is recalled. To cancel without storing the scene, move the cursor to the CANCEL button and press the [ENTER] key.



- To prevent a stored scene from accidentally being overwritten, you can make memory protect settings for each scene number. For details refer to page 208.
- You can use the keys of the SCENE MEMORY section to store a scene even when you are in a screen other than the SCENE screen Scene Mem page. For details refer to page 211.

Recalling a scene

Here's how to recall the scene data stored in a scene memory.

1. Press the [SCENE] key → [F1] key.

The Scene Mem page of the SCENE screen will appear.

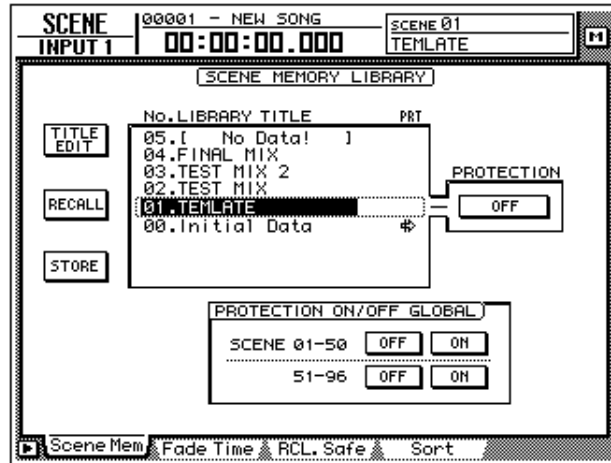

2. Use the [DATA/JOG] dial to select the scene that you wish to recall.
3. Use the CURSOR [◀]/[▶]/[▲]/[▼] keys to move the cursor to the RECALL button and press the [ENTER] key.

A popup window will appear, asking you to confirm the recall.



4. To execute the recall, move the cursor to the OK button and press the [ENTER] key.

To cancel without recalling, move the cursor to the CANCEL button and press the [ENTER] key.



.....
 When you execute the recall, the data of the current scene will be discarded. If you will need to reproduce the current scene, you must save it before recalling another scene.



-
- You can use the keys of the SCENE MEMORY section to recall a scene even when you are in a screen other than the SCENE screen Scene Mem page. For details refer to page 212.
 - You can use program changes to recall AW4416 scenes from an external device (→ P.235), or use the automix function to recall scenes (→ P.225).
 - If desired, you can specify the time (fade time) over which the faders will move to their new locations when a scene is recalled, or exclude specific faders from the recall. For details on these settings, refer to the Reference Guide “SCENE screen/Fade Time page”, “SCENE screen/RCL. Safe page”.

Editing the name of a scene

Here's how you can edit just the name of a stored scene.

1. Press the [SCENE] key → [F1] key.
The Scene Mem page of the SCENE screen will appear.

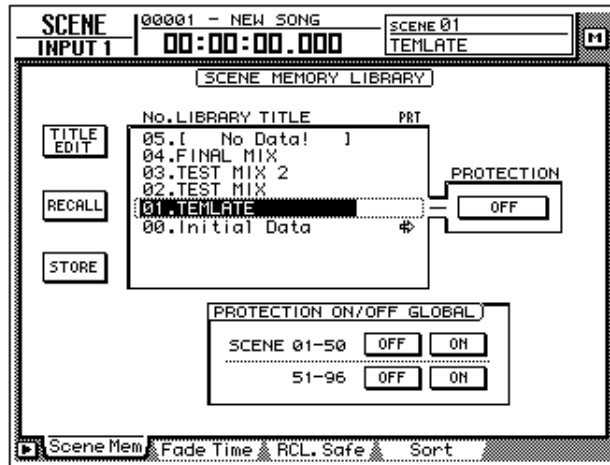

2. Use the [DATA/JOG] dial to select the scene whose scene name you wish to edit.



.....
It is not possible to select a scene that has not been stored, a scene whose protect setting is on, or scene number 00.

3. Use the CURSOR [◀]/[▶]/[▲]/[▼] keys to move the cursor to the TITLE EDIT button in the upper left of the display, and press the [ENTER] key.
The TITLE EDIT popup window will appear, allowing you to edit the scene name.



4. Use the CURSOR [◀]/[▶]/[▲]/[▼] keys and the [ENTER] key to input the new scene name.
5. To finalize the edited scene name, move the cursor to the OK button and press the [ENTER] key.

The scene name will be updated. If you wish to cancel without changing the scene name, move the cursor to the CANCEL button and press the [ENTER] key.

Protecting a scene

You can memory-protect each individual scene that has been stored. A scene number for which protect is turned on can only be recalled.

1. Press the [SCENE] key → [F1] key.
The Scene Mem page of the SCENE screen will appear.

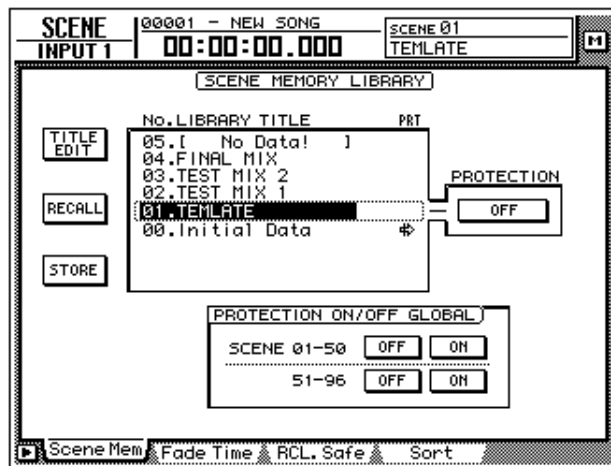

2. Use the [DATA/JOG] dial to select the scene number that you wish to protect.



.....
It is not possible to select a scene number that has not been stored or scene number 00.

3. Use the CURSOR [◀]/[▶]/[▲]/[▼] keys to move the cursor to the PROTECTION field and press the [ENTER] key.

The button display will change from “OFF” to “ON,” indicating that the selected scene is protected. Scenes that are protected will be indicated by a lock icon (🔒) displayed in the PRT column of the list.

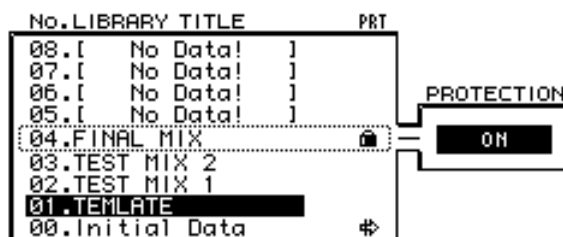

4. To turn protect off, use the [DATA/JOG] dial to select a protected scene in the same page, move the cursor to the PROTECTION button, and press the [ENTER] key.

The button display will change from “ON” to “OFF,” indicating that protect has been turned off.

By using the PROTECTION ON/OFF GLOBAL buttons in the Scene Mem page, you can turn protect on/off for entire groups of scene memories.

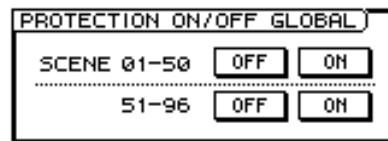

○ **SCENE 01–50 ON/OFF buttons**

Turn protect on/off for scene numbers 01–50.

○ **SCENE 51–96 ON/OFF buttons**

Turn protect on/off for scene numbers 51–96.

Changing the order of scenes

Any scene saved in scene numbers 01–96 can be moved to a different scene number.

1. Press the [SCENE] key → [F4] key.

In this example, scene names “A,” “B,” “C,” and “D” have been saved in scene numbers 01–04.

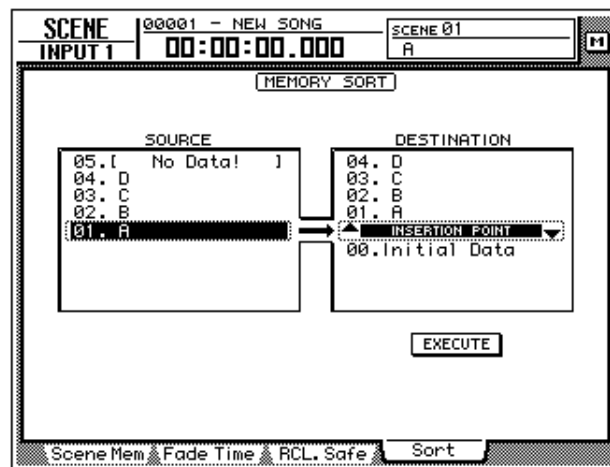

2. Press the CURSOR [◀] key to move the cursor to the list at left (SOURCE), and use the [DATA/JOG] dial to select the move source scene. In this example, we will select scene “D” which is stored in scene number 04.

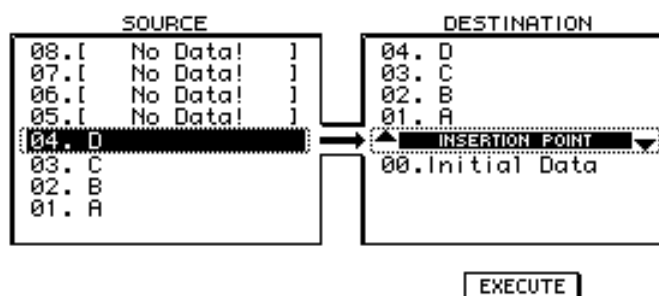

- Press the CURSOR [▶] key to move the cursor to the list at right (DESTINATION), and use the [DATA/JOG] dial to select the move destination. In this example, we will select a location between scene numbers 01 and 02.

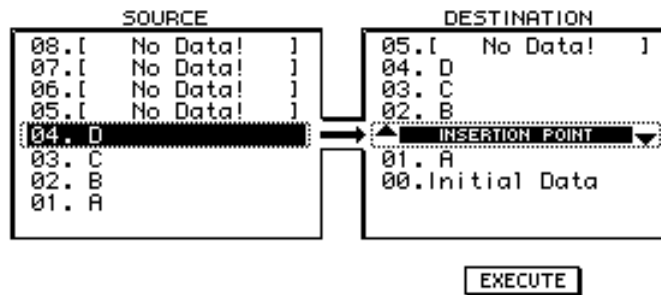

- To move the scene, press the CURSOR [▼] key to move the cursor to the EXECUTE button and press the [ENTER] key.

Scene "D" will move to scene number 02, and the scene numbers of scenes "B" and "C" will be incremented. In this example, scene numbers 01–04 will be rearranged in the order of scenes "A," "D," "B," and "C."

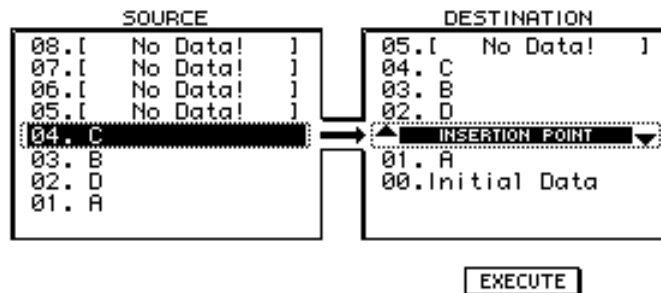

Using keys to store/recall a scene

You can also store/recall a scene by using the keys of the SCENE MEMORY section. By using this method, you can perform these operations even when you are in a screen other than the Scene Mem page of the SCENE screen. For example, this method is convenient when you are editing mix parameters, and wish to overwrite the same scene repeatedly.

Storing a scene

1. Use the [▼]/[▲] keys to select the store destination scene number. The scene number is displayed in the upper right of the level meter/counter.

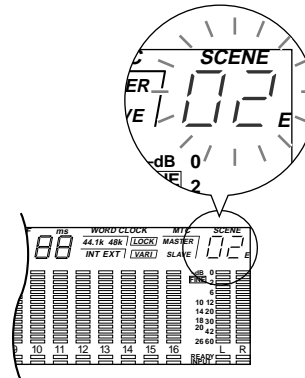

2. Press the [STORE] key. The TITLE EDIT popup window will appear in the display, allowing you to specify the scene name.
3. As desired, use the CURSOR [◀]/[▶]/[▲]/[▼] keys and the [ENTER] key to specify the scene name.
4. To execute the Store operation, move the cursor to the OK button and press the [ENTER] key.



Tip!

.....
 If desired, you can cause the Store operation to be executed immediately when you press the [STORE] key, instead of accessing the popup window. For details on this setting, refer to the Reference Guide “UTILITY screen/Prefer.1 page.”

Recalling a scene

1. Use the [▼]/[▲] keys to select the scene number that you wish to recall.
The scene number is displayed in the upper right of the level meter/counter.
2. Press the [RECALL] key.
A popup window will appear in the display, asking you to confirm the recall.
3. To execute the recall, move the cursor to the OK button and press the [ENTER] key.



.....
If desired, you can cause the Recall operation to be executed immediately when you press the [RECALL] key, instead of accessing the popup window. For details on this setting, refer to the Reference Guide “UTILITY screen/Prefer.1 page.”

14 Automix

This chapter explains how to record and play back automix, and how to edit a recorded automix.

What is automix?

The AW4416 provides an “automix function” that allows controller operations and parameter changes to be recorded in realtime along with the song. Scene recall operations or movements of the channel faders and [ON] keys can be recorded into the automix to completely automate the mix. You will find this particularly valuable when performing ping-pong recording or during mixdown.

The following items can be recorded in the automix.

- Fader operations of each channel
- [ON] key operations of each channel
- Pan operations of each channel
- EQ operations of each channel
- AUX send operations of each channel
- Scene memory/library recall operations

You can record fader operations, pan operations, EQ operations, and scene memory recall operations etc. in separate passes, or use punch-in/out to re-record specific items. The timing and values of individual pieces of recorded data (referred to as “events”) can be edited off-line (i.e., with automix stopped).

Up to sixteen different automixes can be stored in internal memory for a song, and you can recall and use any one of these automixes as desired. (The currently selected automix is called the “current automix.”) The sixteen automixes saved in internal memory are saved on the hard disk as part of the currently selected song (the current song).



.....
The automix of the AW4416 is always linked to the absolute time of the song. When you play back the song, automix will start playing or recording at the same absolute time, and when you stop the song, automix will also stop. It is not possible to use the automix function by itself with the song stopped, or to change the alignment between the starting location of the song and the starting location of automix.

Creating a new automix

In order to record an automix, you must first create a new automix.



When you create a new automix, the contents of the current automix will be erased. If you wish to save the contents of the current automix, refer to page 228 “Storing an automix.”

1. While playing back the beginning of the song, set the channel faders, pan, EQ, and effect send/return etc., and save the settings in a scene memory.

The scene you save here will be the starting point for recording the automix. Alternatively, if you wish to use a previously-recorded scene as the starting point for the automix, recall that scene.

2. Press the [AUTOMIX] key → [F2] key.

The following display will appear.

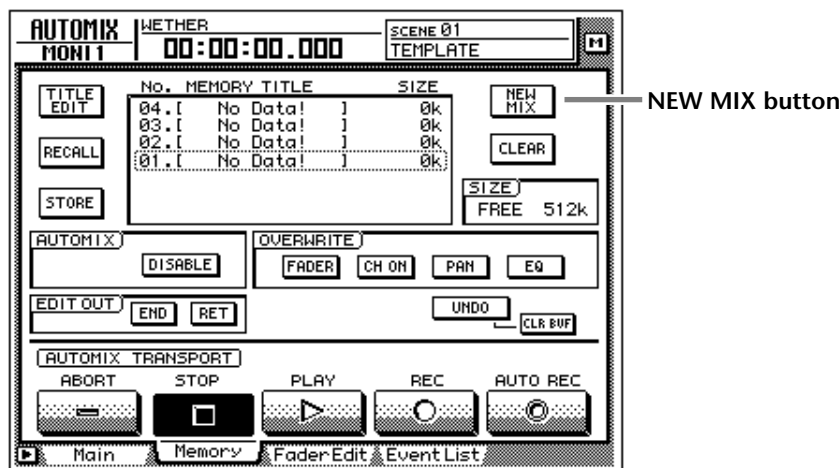

3. Move the cursor to the NEW MIX button in the upper right of the screen, and press the [ENTER] key.

A message of “Will Make New Automix, ARE YOU SURE?” will appear.



4. Move the cursor to the OK button and press the [ENTER] key. The current automix will be erased, and the automix will be initialized.



If you decide to cancel without creating a new automix, move the cursor to the CANCEL button after step 3, and press the [ENTER] key.

5. Press the [F4] key.

The Event List page will appear, where you can edit the events recorded in the current automix.

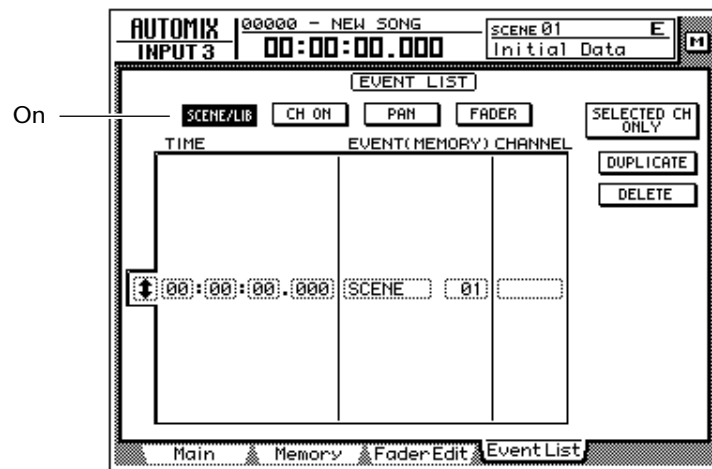

Notice that data for the scene number you saved in step 1 is entered at the “00:00:00.000” location in the TIME column. This event recalls a scene at absolute time location “00:00:00.000” of the song. When you create a new automix, data recalling the current scene (the last recalled or stored scene) will be written into this location. This scene number or time can be modified later if desired.

**Note**

.....
 If an event recalling the scene memory is not displayed when you press the [F4] button, make sure that the SCENE/LIB button in the upper left of the screen is on (highlighted).

Recording the first section

Here we will explain the procedure for recording fader operations of the monitor channels.

1. Press the [HOME] key of the FADER MODE section, and the [MONI] key of the MIXING LAYER section.
Faders 1–16 will function as the channel faders for monitor channels 1–16.
2. Locate the song to a point slightly earlier than where you wish to begin recording the automix.
3. Press the [AUTOMIX] key → [F1] key.

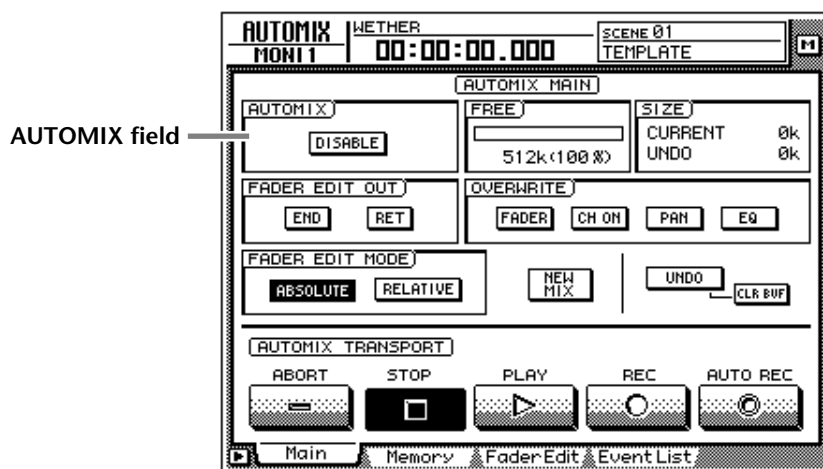

4. Move the cursor to the DISABLE button of the AUTOMIX field, and press the [ENTER] key.

The button will be turned on (highlighted), and its title will change to ENABLE. Now automix is on (i.e., can be recorded or played). Whenever automix is on, the  icon will always be displayed at the left of the on-screen counter.



5. Move the cursor to the OVERWRITE field. Turn the FADER button on, and turn off the remaining buttons (CH ON, PAN, EQ).

The FADER/CH ON/PAN/EQ buttons in the OVERWRITE field are used to select the events that will be recorded in the automix. If a button is on (highlighted), the corresponding type of event can be recorded in the automix. The following events correspond to each button.

- **FADER**.....Operations of the faders and AUX send 1–8 faders of each channel
- **CH ON**.....Operations of the [ON] switches of each channel
- **PAN**.....Pan operations of each channel
- **EQ**.....EQ operations of each channel



Scene and library recall operations can be recorded at any time, regardless of these settings.

6. Move the cursor to the REC button in the screen, and press the [ENTER] key.

The REC button will blink, indicating that the AW4416 is ready to record automix.



7. Use the [SEL] keys to select the channels whose fader operations you wish to record.

When automix is in record-ready mode, you can use the [SEL] keys to select the channel that will be recorded. At this time, the [SEL] keys will blink.

8. Press the [PLAY] key on the top panel to begin song playback.

When you press the [PLAY] key, the REC button in the screen will turn on (highlighted), and automix recording will begin. While automix is being recorded, the  symbol at the left of the on-screen counter will be highlighted (■).

on (highlighted)

AUTOMIX | 00000 - NEW SC
INPUT 3 |  00:00:02.



9. While listening to the song, operate the faders of each channel.

10. When you have finished your operations, press the [STOP] key on the top panel to stop the song.

The on-screen REC button will turn off (normal display), and automix recording will stop. A message will ask whether you wish to update the automix with the newly recorded content.



11. If you wish to update the automix with the newly recorded content, move the cursor to the OK button and press the [ENTER] key.

The automix will be updated. If you move the cursor to the CANCEL button and press the [ENTER] key, the recorded content will be discarded, and the automix will return to its previous state.



Note

- If in step 10 you move the cursor to the ABORT button and press the [ENTER] key, the recorded content will be discarded in the same way, and the automix will return to its previous state.
- Automix recording can also be stopped by using the on-screen STOP button instead of the [STOP] key. In this case, automix recording will stop, but the song will continue playing.
- Even after updating the automix content, you still move the cursor to the UNDO button in the right side of the screen, and press the [ENTER] key to return the automix to its state before recording (Undo). The front panel [UNDO] key cannot be used to undo automix.

Playing back automix

Here's how to play back the recorded automix.

1. Press the [AUTOMIX] key → [F1] key.

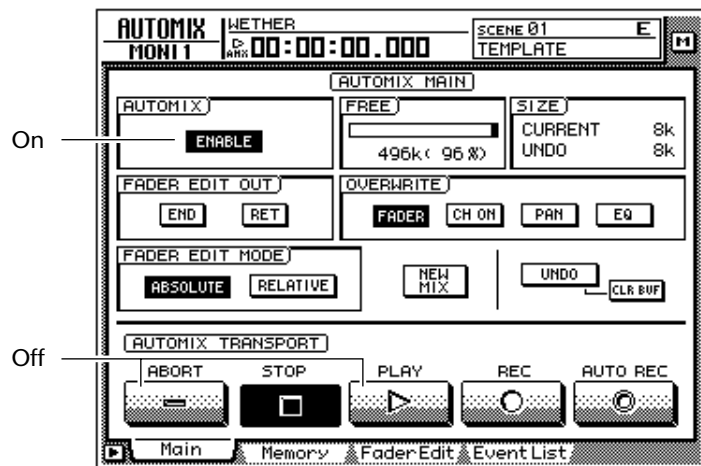

2. Make sure that the button in the AUTOMIX field is displayed as "ENABLE."
If the button is displayed as "DISABLE," move the cursor to the button, and press the [ENTER] key.
3. Make sure that the on-screen REC button and AUTO REC button are turned off.
If they are on, move the cursor to the corresponding button, and press the [ENTER] key.
4. Locate the song to a point slightly earlier than where you began recording automix, and press the top panel [PLAY] key.

The on-screen PLAY button will turn on (the STOP button will turn off), and automix will begin playing automatically.



If you begin playback from the middle of the song, automix will also begin playing from the same location. At this time if any automix events exist before the playback start location, automix will begin playback from a state of having executed all of these earlier events (i.e., the mix will be updated before playback begins).

- To stop automix playback, move the cursor to the on-screen STOP button and press the [ENTER] key, or press the top panel [STOP] key. Even if automix is not stopped manually in this way, it will stop automatically after all of the recorded automix events have been played.

Overwriting events

New data can be overwritten (added or rewritten) onto a previously-recorded automix, either on a different channel or different mix element on the same channel. For example after recording fader operations for monitor channel 1, you can then record fader operations for monitor channel 2, or record pan operations on the same channel. The following explanation shows pan or EQ operations can be overwritten onto an automix that already contains previously-recorded operations of the monitor channel faders.



You can use the same procedure to overwrite (rewrite) the previously-recorded events of a previously-recorded channel. In this case, the previously-recorded content will be erased when you begin overwrite-recording.

- Press the [HOME] key of the FADER MODE section, and the [MONI] key of the MIXING LAYER section.
- Locate the song to a point slightly before the location where you wish to begin overwriting.
- Press the [AUTOMIX] key → [F1] key.

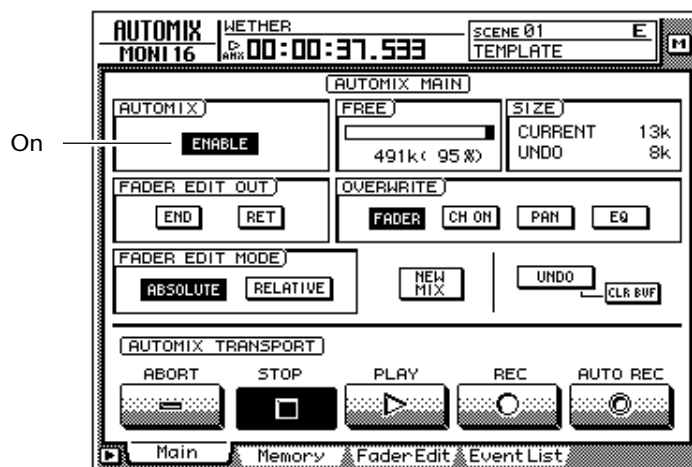

4. Make sure that the button in the AUTOMIX field is displayed as "ENABLE."
5. Move the cursor to the OVERWRITE field. Turn the PAN button and EQ button on, and the remaining buttons (FADER, CH ON) off.
6. Move the cursor to the on-screen REC button, and press the [ENTER] key.
7. Press [SEL] key 1.
Monitor channel 1 will be selected for recording.



.....
You can use the [SEL] keys to select multiple channels for overwriting. However, operations of the [PAN]/[EQ] controls will be recorded only for the channel that you selected last by pressing the [SEL] key.

8. Press the top panel [PLAY] key to begin song playback.
Simultaneously with the start of song playback, the previously-recorded automix will also play back.
9. While listening to the song, operate the [PAN] control.
When recording pan or EQ operations in the automix, it is convenient to use the [PAN]/[EQ] controls at the right of the display.



.....
When you operate the [PAN] control and [EQ] controls, the pan and EQ settings of the corresponding channel will be displayed briefly in the upper part of the screen.

10. When you are finished, press the top panel [STOP] key.
Automix recording will stop, and a message will ask whether you wish to update the automix with the newly recorded content.
11. To update the automix with the newly recorded content, move the cursor to the OK button and press the [ENTER] key.

Automix punch-in/out

If you make a mistake while recording the automix, you can re-record just the location of your error (punch-in/out). As an example here, we will explain how to punch-in/out to re-record the pan operations of monitor channel 1 that you already recorded. When punching-in/out on only a specific channel, it is convenient to use the on-screen AUTO REC button instead of the on-screen REC button.

1. Press the [HOME] key in the FADER MODE section, and the [MONI] key in the MIXING LAYER section.
2. Locate the song to a point slightly earlier than the location where you wish to punch-in.



.....
If you will be punching-in/out repeatedly on the automix, it is convenient to set a locate point at a location earlier than the intended punch-in. For details on locate points, refer to page 109.

3. Press the [AUTOMIX] key → [F1] key.
 Make sure that the AUTOMIX button is displayed as “ENABLE.”

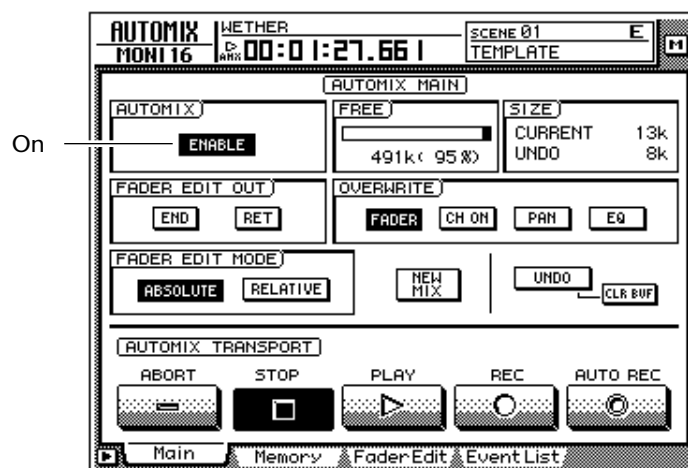

4. Move the cursor to the OVERWRITE field. Turn the PAN button on, and the remaining buttons (FADER, CH ON, EQ) off.
5. Move the cursor to the AUTO REC button in the lower right of the screen, and press the [ENTER] key.
 The AUTO REC button will turn on.



.....
***Note** When you use the AUTO REC button instead of the REC button, you can select the recording channel after placing automix in record-ready mode. It is not necessary to use the [SEL] keys to select the channel beforehand.*

6. Press the top panel [PLAY] key to play back the song.
When song playback is started with the AUTO REC button on, the REC button will be turned on automatically, and automix will be in record mode. However, recording will not actually occur since the recording channel has not yet been selected.
7. When the song arrives at the punch-in location, press [SEL] key 1 (monitor channel 1).
Recording of pan operations on the corresponding channel will begin at the moment you press the [SEL] key (punch-in). At this time, the corresponding [SEL] key will blink.
8. While listening to the song, operate the [PAN] control.
9. When you are finished, press the [SEL] key of the same channel once again.
The [SEL] key of the corresponding channel will go dark, and recording will end (punch-out). Automix will still be in a recordable state, but recording will not actually occur since no recording channel is selected.

**Note**

.....

If you did not operate the [PAN] control in step 8, the currently-recorded pan operation events between the punch-in and punch-out locations will be erased. This method can be used to erase specific events from the corresponding section of the song.

10. Press the top panel [STOP] key.
A message will ask whether you wish to update the automix with the newly recorded content. If you wish to update the automix, move the cursor to the OK button and press the [ENTER] key.
When you stop the song, the on-screen REC will return to the Off state. However, since the AUTO REC button will remain on, you can punch-in on the automix again by pressing the [PLAY] key. If you wish to turn off the AUTO REC button, move the cursor to the AUTO REC button, and press the [ENTER] key.

Editing the fader movements

Fader operation events recorded in the automix can be precisely edited in real-time while watching the fader movements in a special screen. As an example here, we will explain how to edit the previously-recorded fader movements of monitor channel 1.

1. Press the [HOME] key of the FADER MODE section, and the [MONI] key of the MIXING LAYER section.
2. Locate the song to a point slightly earlier that where you wish to punch-in.
3. Press the [AUTOMIX] key → [F1] key.
Make sure that the button in the AUTOMIX field is displayed as “ENABLE.”

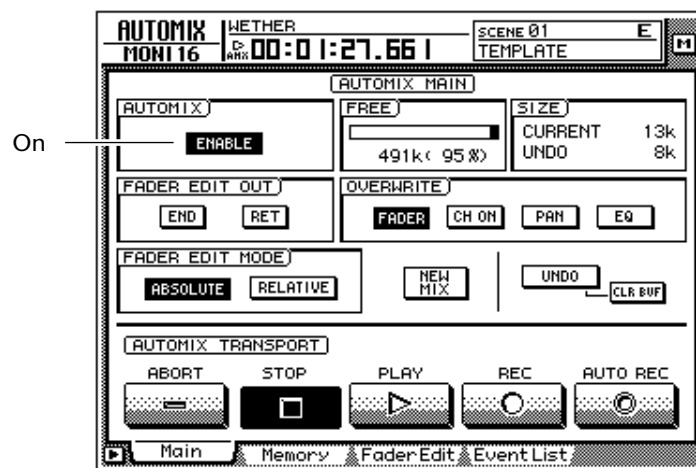

4. Move the cursor to the OVERWRITE field. Turn the FADER button on, and the other buttons (CH ON, PAN, EQ) off.
5. Press the [F3] key.

A page will appear in which the current locations for the faders of each channel (monitor channels 1–16) are shown as a bar graph. When you wish to make detailed edits to the fader movements recorded in the automix, it is convenient to do so while viewing this screen.

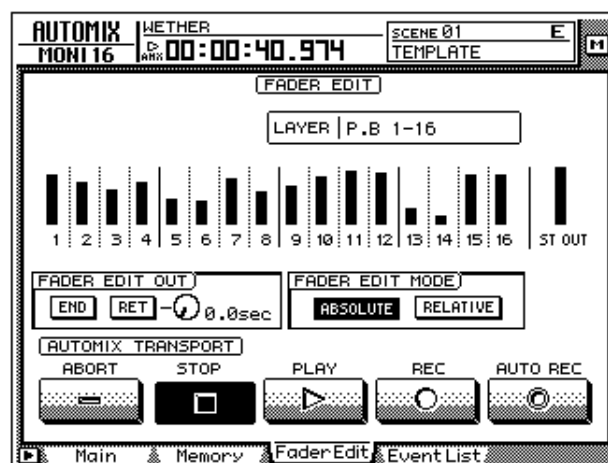

6. Make sure that the **ABSOLUTE** button in the **FADER EDIT MODE** field is turned on.

The two buttons of the **FADER EDIT MODE** field in the screen are used to select the fader editing method. When the **ABSOLUTE** button is on, previously-recorded events will be erased, and new events will be recorded.



Note

Use the **RELATIVE** button when you wish to make relative changes to the previously-recorded fader events. For details refer to the Reference Guide "AUTOMIX screen/Main page."

7. Move the cursor to the on-screen **AUTO REC** button, and press the **[ENTER]** key.
8. Press the top panel **[PLAY]** key to play back the song.
When song playback is started with the **AUTO REC** button on, the **REC** button will be turned on automatically, and automix will be in record mode. However, recording will not actually occur, since a recording channel has not yet been selected.
9. While listening to the song, press **[SEL]** key 1 (monitor channel 1) at the point where you wish to punch-in, and begin operating the fader.
Punch-in will begin at the instant you press the **[SEL]** key. When you operate the fader, the previously-recorded position of the fader and the position currently being recorded will both be displayed in the bar graph. The upward or downward arrow shown beside the bar graph indicates the direction in which you can move the fader to return to the previously-recorded position.

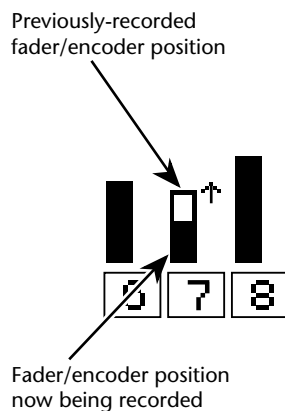

(1) If the fader/encoder is lowered below the previous value

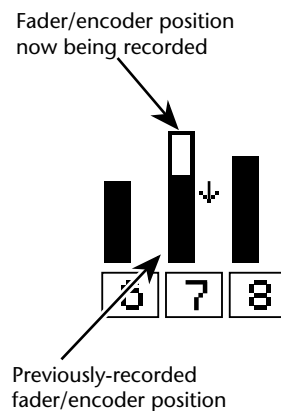

(2) If the fader/encoder is raised above the previous value

10. When you are finished operating the fader, press the **[SEL]** key of the same channel to punch-out.



Note

If you turn on the **RET** button in the **FADER EDIT OUT** field before you begin punch-in, the faders will automatically return to the previously-recorded positions as soon as you punch-out. This is convenient when you wish to change the level only for the punch-in/out area. You can use the knob located at the right of the **RET** button to adjust the time over which faders will return to the previously-recorded positions. For details refer to the Reference Guide "AUTOMIX screen/Main page."

11. When you are finished with punch-in/out, press the top panel [STOP] key.

A message will ask you whether you wish to update the automix with the newly recorded content. If you wish to update the automix, move the cursor to the OK button and press the [ENTER] key.

Editing automix off-line

While the AW4416 is off-line, you can adjust the timing or value of previously-recorded events, or delete unwanted events. The following types of event can be edited off-line.

- Fader operations for each channel
- [ON] key operations for each channel
- Pan operations for each channel
- Scene memory or library recall operations



Event times are always displayed as absolute song time. For this reason, we recommend that you display the absolute song time in the counter when editing events off-line (→ P.39).

As an example, we will explain how to edit a scene recall or library recall event.

1. Press the [AUTOMIX] key → [F4] key.

The EventList page will appear, displaying a list of the events recorded in automix.

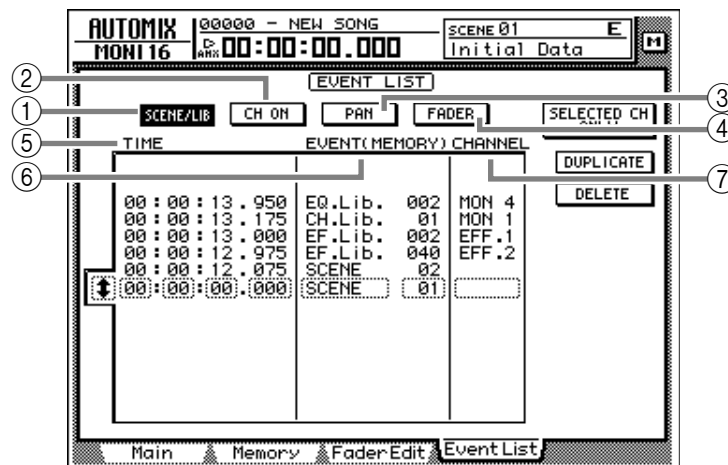

Use the SCENE/LIB, CH ON, PAN, and FADER buttons in the upper part of the screen to select the type of events that will be displayed. The following events correspond to each button.

- ① **SCENE/LIB button**.....Scene or library recall operations
- ② **CH ON button**.....[ON] key operations for each channel
- ③ **PAN button**.....Pan operations for each channel
- ④ **FADER button**.....Fader operations for each channel

2. Move the cursor to the SCENE/LIB button, and press the [ENTER] key.
The scene/library recall events recorded in the automix will be displayed in the list. The event enclosed by the dashed line in the center of the list is the event currently selected for editing.
3. Move the cursor to the  at the left of the list, and rotate the [DATA/JOG] dial to scroll the list and select the event that you wish to edit.
4. Use the CURSOR [◀]/[▶] keys to move the cursor to the data item within that event that you wish to edit.

	00:00:13.950	EQ.Lib.	002	MON 4
	00:00:13.175	CH.Lib.	01	MON 1
	00:00:13.000	EF.Lib.	002	EFF.1
	00:00:12.975	EF.Lib.	040	EFF.2
	00:00:12.075	SCENE	02	
	00:00:00.000	SCENE	01	

⑤ TIME

The timing at which the event will be executed is displayed as “hours:minutes:seconds:milliseconds.”

⑥ EVENT

This area shows the type and value of the event. The type of events that can be selected in this area will depend on which of the buttons above has been pressed. When the SCENE/LIB button is on, the following events can be selected.

- **SCENE**Scene memories. The value at the right is the number of the scene that will be recalled.
- **EQ.Lib.**EQ libraries. The value at the right is the number of the EQ library that will be recalled.
- **DY.Lib.**Dynamics libraries. The value at the right is the number of the dynamics library that will be recalled.
- **EF.Lib.**Effect libraries. The value at the right is the number of the effect library that will be recalled.
- **CH.Lib.**Channel libraries. The value at the right is the number of the channel library that will be recalled.

⑦ CHANNEL

This shows the channel (input channels 1–24, monitor channels 1–16, stereo output channel, return channels 1/2) for which the event will be recalled. This will be blank if scene memory has been selected in ⑥.

5. Rotate the [DATA/JOG] dial to modify the value of the item where the cursor is located.

	00:00:13.950	EQ.Lib.	005	MON 4
	00:00:13.175	CH.Lib.	01	MON 1
	00:00:13.000	EF.Lib.	002	EFF.1
	00:00:12.975	EF.Lib.	040	EFF.2
	00:00:12.075	SCENE	02	
	00:00:00.000	SCENE	01	



.....
When you change the timing of an event, the cursor may jump one or more rows of the list to another location. This is because events are sorted in order of time, and is not a malfunction. The timing of events can be adjusted in fine steps of 25 msec.



.....
If the SELECTED CH ONLY button in the upper right of the screen is turned on, the screen will display only events of the channel selected by the [SEL] key.

6. To add a new event, move the cursor to the DUPLICATE button in the upper right of the screen, and press the [ENTER] key.
The event currently selected for editing will be duplicated. Modify its timing, event type, and value as desired.
7. To delete an unwanted event, move the cursor to the DELETE button in the upper right of the screen, and press the [ENTER] key.
The event currently selected for editing will be deleted.



.....
AUX 1–8 send level or EQ operations cannot be performed off-line. You must use punch-in/out to overwrite or delete these operations in the specified range.

Storing an automix

When you have completed the current automix, you should assign a name and store it in automix memory. Sixteen automixes can be stored in internal memory.



Note

Automix data that you store is saved on the hard disk as part of the current song. This means that you can create up to sixteen different automix versions for one song, and compare them at any time.

1. Press the [AUTOMIX] key → [F2] key.

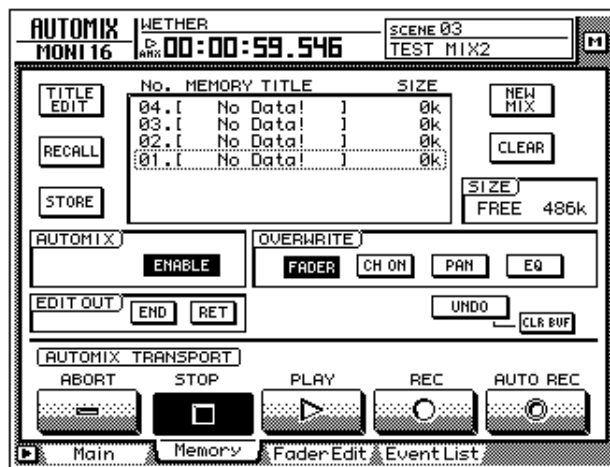

2. Move the cursor to the list in the center of the screen, and rotate the [DATA/JOG] dial to select the store destination automix number. You can select automix numbers 01–16. Vacant automix numbers will be displayed in the list as “[No Data!].”
3. Move the cursor to the STORE button located at the left of the list, and press the [ENTER] key. A screen will appear where you can input the automix name. Assign a name of up to sixteen characters. (For details on inputting characters, refer to page 60.)



4. After you have input the automix name, move the cursor to the OK button and press the [ENTER] key. The current automix data will be stored in the selected automix number.

**Tip!**

.....

If you turn *STORE CONFIRMATION* “OFF” in the *Prefer.1* page of the *UTILITY* screen ([*UTILITY*] key → [*F2*] key), the automix will be stored in the specified automix number without this screen appearing. This method is convenient when you wish to repeatedly overwrite an automix into the same automix number.



.....

The internal automix memory is shared between the current automix and a maximum of sixteen stored automixes. This means that if the current automix occupies a large amount of automix memory, it may be impossible to store the automix even if there are vacant automix numbers in the list. If this occurs, clear previously-saved automix data that you no longer need (Refer to the Reference Guide “*AUTOMIX* screen/Memory page”), and then execute the *Store* operation once again.

Recalling an automix

Here's how to recall an automix that was saved in memory.

1. Press the [AUTOMIX] key → [F2] key.

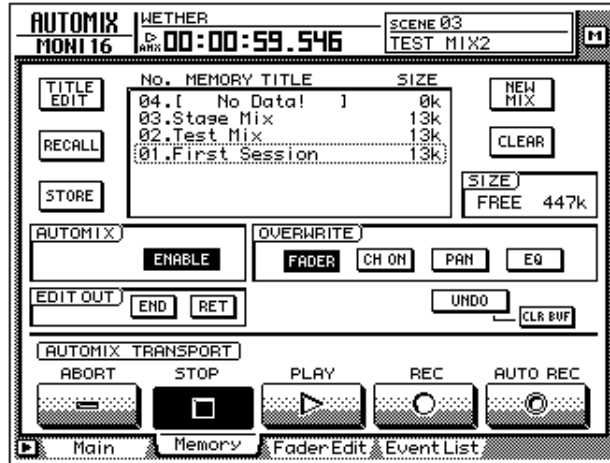

2. Move the cursor to the list in the center of the screen, and rotate the [DATA/JO] dial to select the automix number that you wish to recall.

No.	MEMORY TITLE	SIZE
06.	[No Data!]	0k
05.	[No Data!]	0k
04.	[No Data!]	0k
03.	Stage Mix	1k
02.	Test Mix	1k
01.	First Session	1k

3. Move the cursor to the RECALL button located at the left of the list, and press the [ENTER] key.

A message will ask you to confirm that you wish to recall the automix number selected in step 2.



4. Move the cursor to the OK button and press the [ENTER] key.

The recall will be executed, and the current automix will be replaced by the automix data that you recalled.

15 MIDI

This chapter explains how you can use MIDI when operating the AW4416.

What you can do using MIDI

On the AW4416, MIDI can be used to perform the following operations.

○ **Change scenes by remote control**

By transmitting program changes from an external device to the AW4416, you can switch AW4416 scenes by remote control. You can also cause program changes to be transmitted to an external device when you select scenes on the AW4416.

○ **Synchronize with an external device via MTC/MIDI Clock**

Synchronization messages such as MTC (MIDI Time Code) or MIDI Clock can be transmitted from the AW4416 to an external device such as a MIDI sequencer, so that it will operate in synchronization with the AW4416 song. (MTC can also be received by the AW4416.)

○ **Remote control via MMC**

MMC (MIDI Machine Control) messages from a computer or other external device can be received to remotely control the operation of the AW4416's transport, or to select/defeat recording tracks.

MIDI connectors and the TO HOST connector

The AW4416 provides the following connectors used to convey MIDI messages.

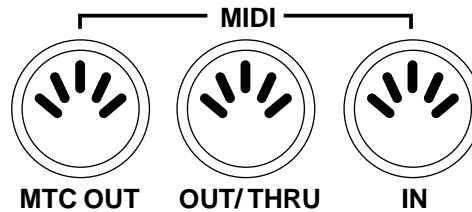

○ MIDI IN connector

MIDI messages such as program change, MMC, and MTC are received at this connector.

○ MIDI OUT/THRU connector

By changing the setting of an internal parameter, this connector can function either as a MIDI OUT connector or a MIDI THRU connector. When used as a MIDI OUT connector, it will transmit MIDI messages such as program change, MMC, and MIDI Clock. When used as a MIDI THRU connector, it will re-transmit the messages received at the MIDI IN connector without change.

○ MTC OUT connector

This is a dedicated output connector for MTC.

TO HOST

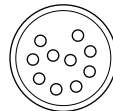

○ TO HOST connector

A separately sold cable can be used to connect this to the serial port of your computer, allowing MIDI messages to be exchanged directly between the AW4416 and your computer. In order to use this connector, you will need to set the MIDI port setting to "TO HOST PC1," "TO HOST PC 2," or "TO HOST MAC," depending on the computer you are using (→ P.233).



- The TO HOST connector cannot be used simultaneously with the MIDI IN connector and MIDI OUT/THRU connector.
- MTC cannot be transmitted via the TO HOST connector. If you need to transmit MTC to your computer, use the MTC OUT connector.
- Regardless of the port setting, the OUT/THRU connector will function as THRU if MIDI THRU is selected.

Using the TO HOST connector for direct connection to your computer

Connections

To exchange MIDI messages directly between the AW4416 and your computer, use a separately sold cable to connect the TO HOST connector of the AW4416 to the serial port of your computer.

Connection to an IBM/PC series computer

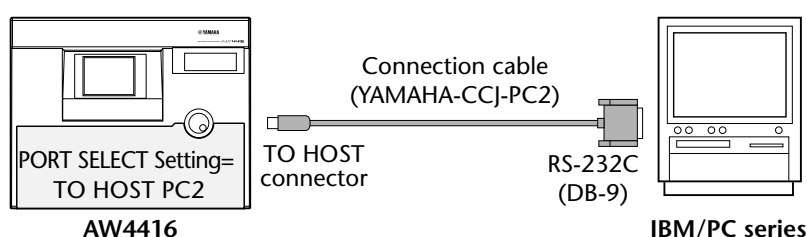

Connection to an Apple Macintosh series computer

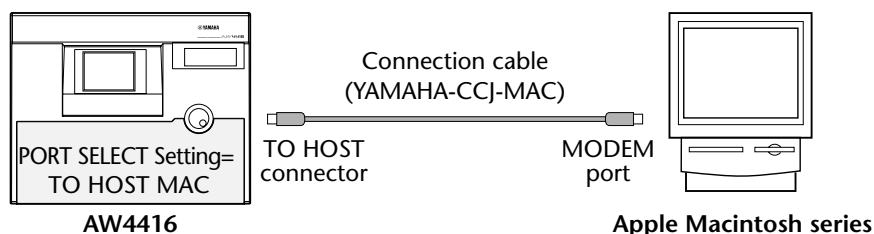

○ IBM/PC series: D-SUB9P → mini DIN8P cross cable

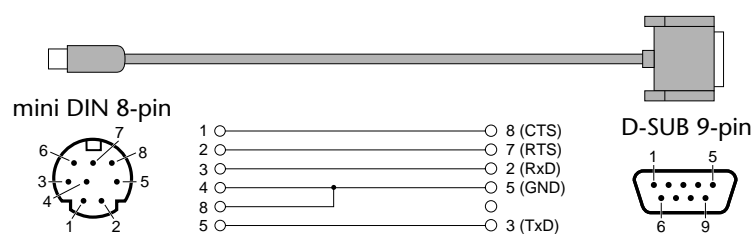

If your PC has a D-SUB 25-pin connector, use a Yamaha CCJ-PC1 cable together with a male/female conversion adapter.

○ Apple Macintosh series: 8-pin system peripheral cable

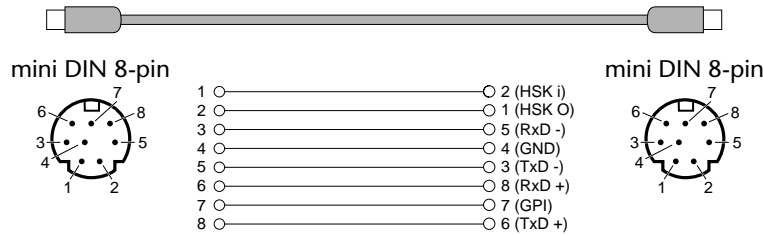

In the case of some Macintosh computers that have no modem/printer cable, it is not possible to make direct connections to the AW4416's TO HOST connector.

Setting the PORT SELECT parameter

In order to use the TO HOST connector, the AW4416's PORT SELECT parameter must be set appropriately for the type of computer that is selected.

1. Press [MIDI], and then press the [F1] key.

The MIDI Setup page will appear, allowing you to make MIDI-related settings for the AW4416.

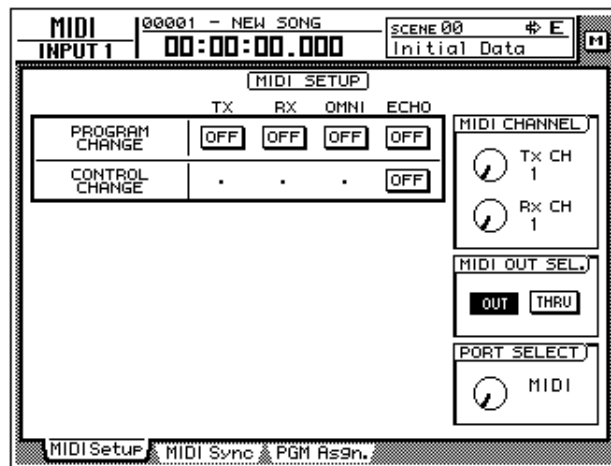

2. Move the cursor to the PORT SELECT knob, and use the [DATA/JOG] dial to select the setting appropriate for your computer.

The following types of computer require the following PORT SELECT parameter settings.

- IBM/PC series: TO HOST PC 2 (38.4 kbps)
- Apple Macintosh series (models with modem/printer port): TO HOST MAC



- Depending on your system, you may need separate driver software in order to make serial port connections.
- When connecting to a Macintosh, you must set the MIDI interface clock setting of your application to 1 MHz.

Switching AW4416 scenes from an external device

By transmitting program changes from an external device to the AW4416, you can recall AW4416 scene memories by remote control.

1. Connect the MIDI OUT connector of the external device to the MIDI IN connector of the AW4416.

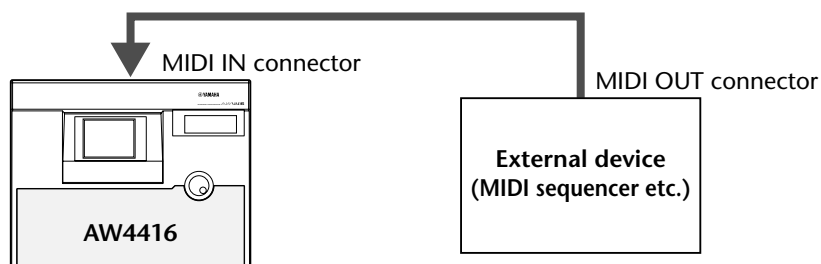

2. Press the [MIDI] key, and then press the [F1] key.
The MIDI Setup page will appear in the display. In this page you can select the MIDI channel on which the AW4416 will transmit and receive, and specify whether program changes and control changes will be transmitted and received.

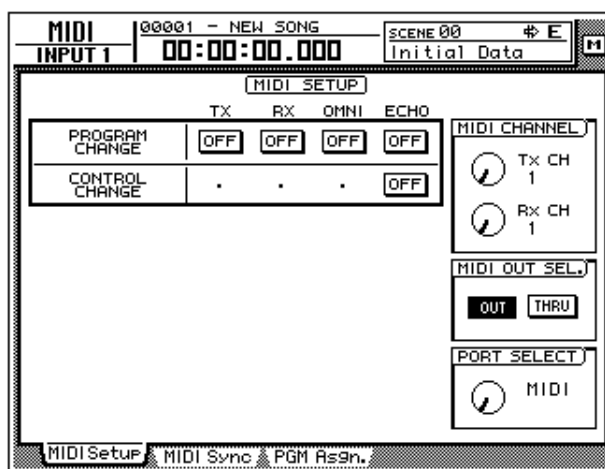

3. Move the cursor to the RX (receive) button in the PROGRAM CHANGE area, and press the [ENTER] key.
The button will change from “OFF” to “ON.” With this setting, program changes can be received.
4. Move the cursor to the Rx CH knob in the MIDI CHANNEL area, and rotate the [DATA/JOG] dial to select the MIDI receive channel of the AW4416.



.....
If you turn on the OMNI button in the PROGRAM CHANGE area, program changes of all channels will be received.

5. Press the [F3] key.

The PGM Asgn. page will appear, allowing you to assign AW4416 scene numbers to each program number 1–128. The “PGM CHG.” column is the program change number, and the “SCENE MEM.No./TITLE” column is the scene number and title.

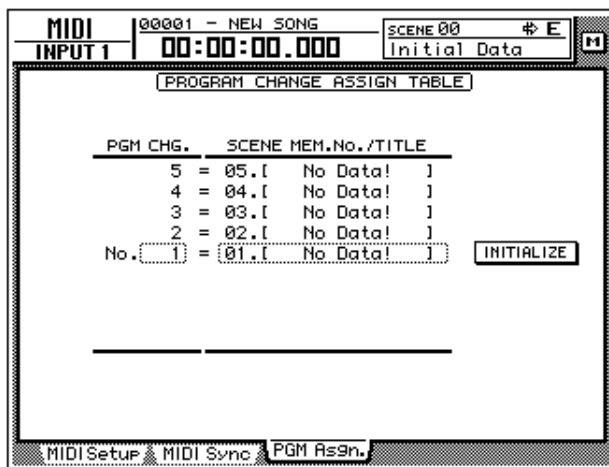

If you move the cursor to the INITIALIZE button located in the right of the screen and press the [ENTER] key, the scene number assignments will be initialized; scene numbers 01–96 will be assigned to program numbers 1–96, and scene number 00 will be assigned to program change 100. (All other program change numbers will be “-NO ASSIGN-.”)

6. Move the cursor to the PGM CHG. column, and use the [DATA/JOG] dial to select a program change number (1–128).

PGM CHG.	SCENE MEM.No./TITLE
14	= 14.[No Data!]
13	= 13.[No Data!]
12	= 12.[No Data!]
11	= 11.[No Data!]
No. 10	= 10.[No Data!]
9	= 09.[No Data!]
8	= 08.[No Data!]
7	= 07.[No Data!]
6	= 06.[No Data!]

INITIALIZE

7. Move the cursor to the right, and use the [DATA/JOG] dial to select the scene number (00–96) that will be assigned to the program change number you selected in step 6.

If you select “–NO ASSIGN–,” no scene number will be assigned to that program change number. If you select a scene number which has not been stored in the AW4416’s internal memory, the title area will indicate “[No Data!].”

PGM CHG.	SCENE MEM.No./TITLE
14 =	14.[No Data!]
13 =	13.[No Data!]
12 =	12.[No Data!]
11 =	11.[No Data!]
No. 10 =	01.Initial Mix
9 =	09.[No Data!]
8 =	08.[No Data!]
7 =	07.[No Data!]
6 =	06.[No Data!]

INITIALIZE



.....

If the same scene number is assigned to multiple program change numbers, recalling the corresponding scene will cause only the lowest of the assigned program change numbers to be transmitted. When you recall a scene number to which no program change is assigned, no program change will be transmitted.

8. Transmit a program change message from the external device.

The AW4416 will recall the scene corresponding to the program change that was received.



.....

When you use the AW4416’s keys to recall a scene, you can cause a program change corresponding to that scene to be transmitted. To do so, turn on the Tx button in the PROGRAM CHANGE area in the screen for step 2.

Using MTC to synchronize the AW4416 and a MIDI sequencer

MTC can be transmitted from the MTC OUT connector of the AW4416 to an external device such as a MIDI sequencer or computer, causing the MIDI sequencer (or computer-based sequencer program) to synchronize to the AW4416 song.

1. Use a MIDI cable to connect the AW4416's MTC OUT connector to the MIDI IN connector of your MIDI sequencer.

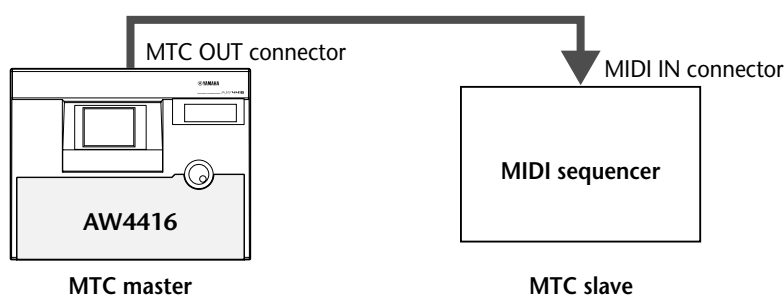

2. Press the [MIDI] key, and then press the [F2] key.
The following screen will appear in the display.

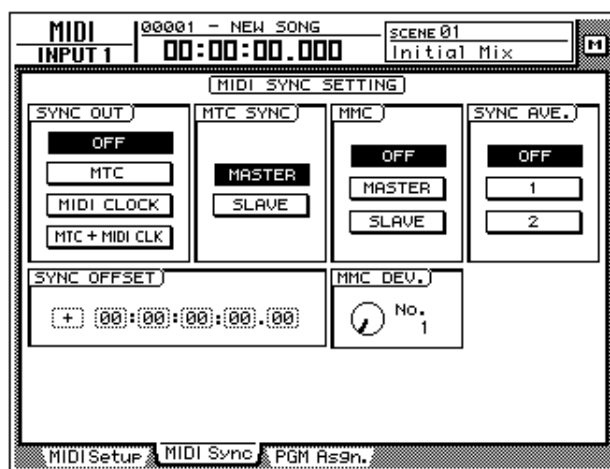

3. Move the cursor to the MASTER button in the MTC SYNC area, and press the [ENTER] key.
With this setting, the AW4416 will function as the MTC master (the device that transmits MTC).
4. Move the cursor to the MTC button in the SYNC OUT area, and press the [ENTER] key.
With this setting, MTC will be transmitted from the MTC OUT connector when the AW4416 is running.
5. If you need to set the MTC frame rate, press the [SONG] key and then press the [F2] key.

The following screen will appear in the display.

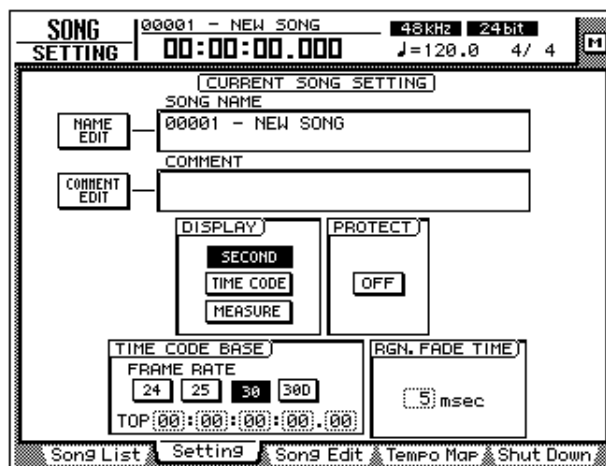

6. Move the cursor to the TIME CODE area, and turn on one of the 24/25/30/30D (drop) buttons to select the frame rate.

By default, a frame rate of 30 is selected. The frame rate you select here will also affect the time code that is displayed in the counter.

7. If you wish to display time code in the counter, move the cursor to the TIME CODE button in the DISPLAY area, and press the [ENTER] key.
8. Set your MIDI sequencer so that it will follow MTC messages that it receives, and put it in playback mode. At this time, make sure that the frame rate setting of the sequencer matches the setting that you selected in step 6.

With these settings, the MIDI sequencer will be the MTC slave (the device that receives MTC).

9. Record or play back the AW4416 song.

When the AW4416 begins running, MTC will be transmitted from the MTC OUT connector to the external MIDI sequencer, causing it to begin synchronized operation from the same location.



- It is possible to use the AW4416 as the MTC slave. However in order to ensure that the recorder section operates with maximum stability, we recommend that you use the AW4416 as the MTC master whenever possible.
- For the MTC time that is transmitted by the AW4416, you can specify an offset value that will be applied to the internal absolute time (ABS time). For details refer to the Song screen/Setting page in the Reference Guide.

Using MIDI Clock to synchronize the AW4416 and a MIDI sequencer

Here we will explain how MIDI Clock (and Song Position Pointer) messages can be transmitted from the AW4416 instead of MTC, and used to synchronize an external MIDI sequencer. Use this method if the MIDI sequencer or rhythm machine you wish to synchronize with the AW4416 does not support MTC, or if you wish to specify the locate positions in terms of measures/beats.

1. Use a MIDI cable to connect the AW4416's MIDI OUT connector to the MIDI IN connector of your MIDI sequencer.

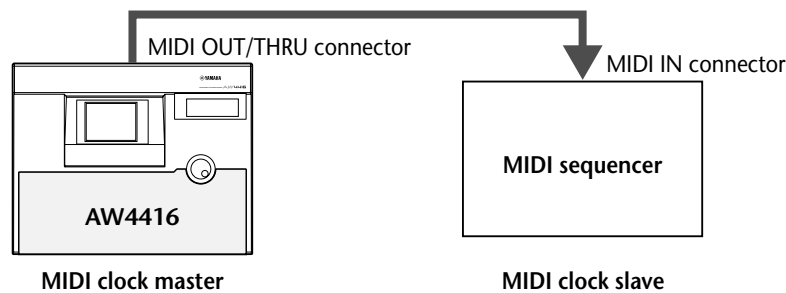

2. Press the [MIDI] key, and then press the [F1] key.
The MIDI Setup screen will appear in the display.

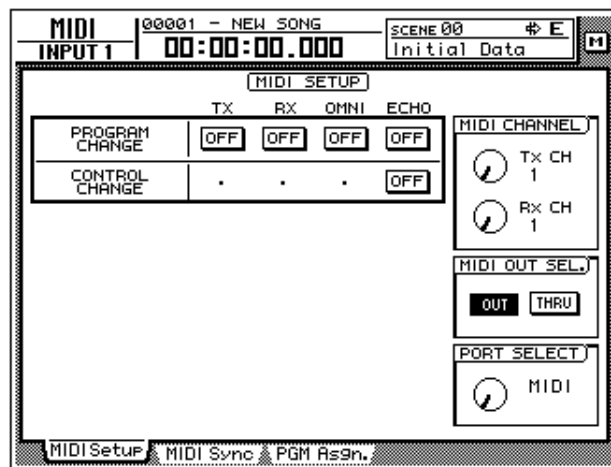

3. Move the cursor to the OUT button of the MIDI OUT SEL. area, and press the [ENTER] key.
The MIDI OUT SEL. buttons select whether the MIDI OUT/THRU connector will function as a MIDI OUT connector (when the OUT button is on) or as a MIDI THRU connector (when the THRU button is on). In this example we will turn on the OUT button, in order to output the MIDI clock that is generated inside the AW4416.

- Press the [F2] key.
The MIDI Sync page will appear in the display.

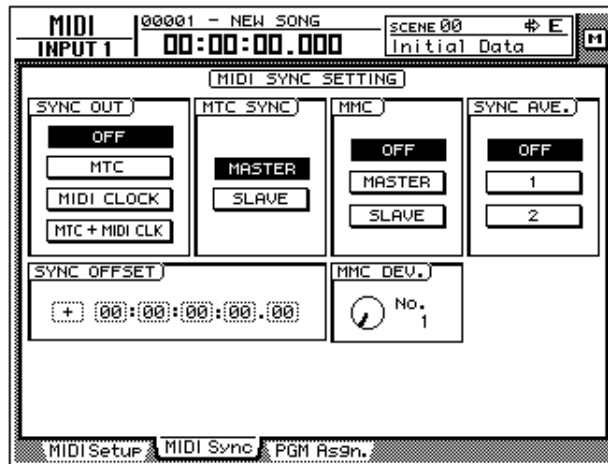

- Move the cursor to the MIDI CLOCK button in the SYNC OUT area, and press the [ENTER] key. Also make sure that the MASTER button in the MTC SYNC area is on.

With these settings, MIDI Clock messages will be transmitted from the MIDI OUT/THRU connector when the AW4416 is running.

- Press the [SONG] key → [F2] key, and turn on the MEASURE button in the DISPLAY area.

The counter display will be in measure/beat/tick (1/960th of a quarter note) units. With this setting, you will be able to specify locate positions in measure/beat units.

- Press the [SONG] key, and then press the [F4] key.
The left side of the screen will show the beat map in which you can input time signature data for the song, and the right side of the screen will show the tempo map in which you can input tempo data. With the default settings for a song, a time signature of 4/4 and a tempo of BPM=120.0 will be input at measure 1.

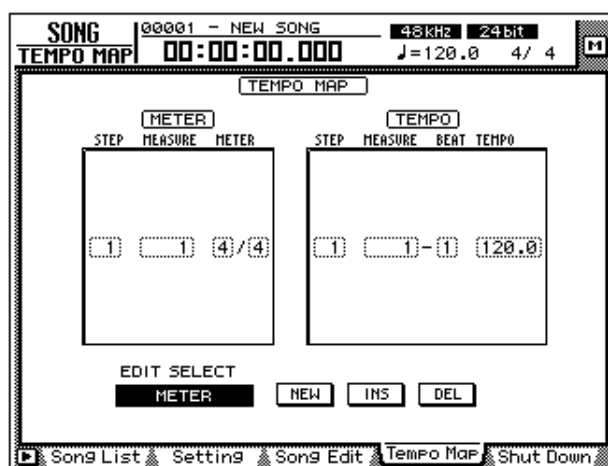

In order for a MIDI sequencer to synchronize to the MIDI Clock messages send from the AW4416, tempo settings and time signature settings must be made on the AW4416. You can input this tempo data and time signature data in the Tempo Map page described above.

8. Move the cursor to the METER area of the beat map, and use the [DATA/JOG] dial to specify the time signature for measure 1.
The time signature can be specified in a range of 1/2–8/8.
9. If you wish to change time signatures in the middle of the song, switch the EDIT SELECT buttons at the bottom of the screen to METER. Then move the cursor to the NEW button and press the [ENTER] key.
New time signature data will be added, allowing you to specify the new location (measure) and time signature. (For details refer to the Song screen/Tempo Map page in the Reference Guide.)
10. Move the cursor to the TEMPO column of the tempo map, and use the [DATA/JOG] dial to specify the tempo for the first measure.
The tempo (BPM) can be set in 0.1 units over a range of 20.0–300.0.
11. If you wish to change tempo in the middle of the song, switch the EDIT SELECT buttons at the bottom of the screen to TEMPO. Then move the cursor to the NEW button and press the [ENTER] key.
New tempo data will be added, allowing you to specify the new location (measure/beat) and tempo. (For details refer to the Song screen/Tempo Map page in the Reference Guide.)
12. Make settings on your MIDI sequencer so that it will synchronize to an external MIDI clock, and put it in playback-ready mode.
13. Record/play back the AW4416 song.
When you specify a location on the AW4416 in measure/beat units, the external MIDI sequencer will also move to the same location. When the AW4416 begins running, the MIDI sequencer will begin running in synchronization according to the MIDI clock that is being transmitted.



.....
The internal metronome of the AW4416 will sound according to the tempo data and time signature data you specify here.

Using MMC to control the AW4416

MMC (MIDI Machine Control) is a group of MIDI messages used to control the transport of an audio recorder etc. from an external MIDI device. The AW4416 supports MMC transmission and reception. This means that an external MIDI device can control AW4416 transport operations, locate operations, selection and disabling of recording tracks, or conversely that the AW4416 can control transport and other operations on another MMC-compatible device.

In this section we will explain how MMC can be used to control various operations of the AW4416 from an external MIDI sequencer while MTC is being used to synchronize the AW4416 and MIDI sequencer.

1. Connect the AW4416's MIDI IN connector to the MIDI OUT connector of the MIDI sequencer, and connect the AW4416's MTC OUT connector to the MIDI IN connector of the MIDI sequencer.

In this case, the MIDI sequencer will be the MMC master (the device transmitting MTC) and MTC slave, and the AW4416 will be the MMC slave (the device receiving MMC) and MTC master.

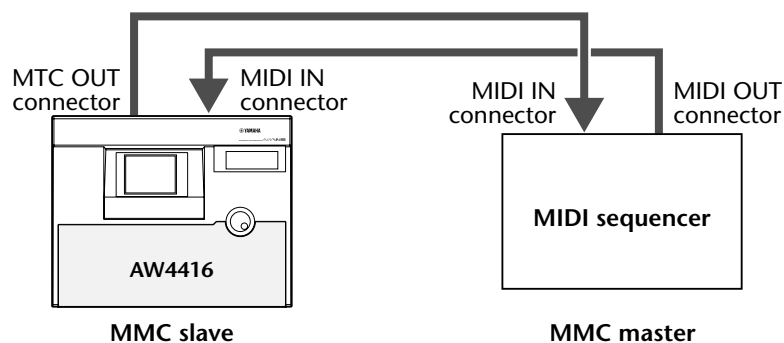

2. As described in "Using MTC to synchronize the AW4416 and a MIDI sequencer" (→ P.238), make settings on both devices so that the AW4416 and MIDI sequencer will run in synchronization.
3. Press the [MIDI] key, and then press the [F2] key.

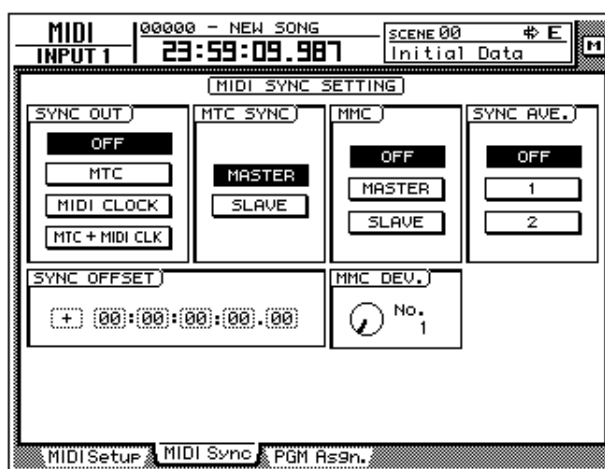

4. Move the cursor to the SLAVE button in the MMC area, and press the [ENTER] key.
With this setting the AW4416 will function as an MMC slave device.
5. Move the cursor to the MMC DEV. knob, and use the [DATA/JOG] dial to set the MMC device ID.
The device ID is a number in the range of 1–127 that is used to distinguish the device to be controlled when a single system contains multiple MMC-compatible devices. By default, the AW4416 is set to device ID = 1.



6. On your MIDI sequencer, set the device ID of the MMC device to be controlled to the same setting as in step 5.

**Note**

.....
If necessary, you can specify the AW4416 recording track after step 6, and control recording operations in step 7. For details on selecting the recording track and on controlling record operations, refer to the manual for your MIDI sequencer.

7. Start playback on your MIDI sequencer.

When you start the MIDI sequencer, MMC commands will be transmitted to the AW4416, and the AW4416 will begin running. At this time, MTC will be transmitted from the AW4416's MTC OUT connector to the MIDI sequencer, and the sequencer will synchronize to the AW4416.

16 Backing up and restoring songs

This chapter explains how part or all of the song data on the internal hard disk can be backed up to a SCSI device (such as a CD-RW drive or MO drive), and how backed-up data can be restored to the internal hard disk. This chapter also explains how to re-format the internal hard disk, and how to erase CD-RW media.

Selecting the backup format

When using removable media such as MO as the backup destination, you must first select the backup format.

1. Press the [UTILITY] key → [F4] key.
The UTILITY screen Prefer.3 page will appear in the display.

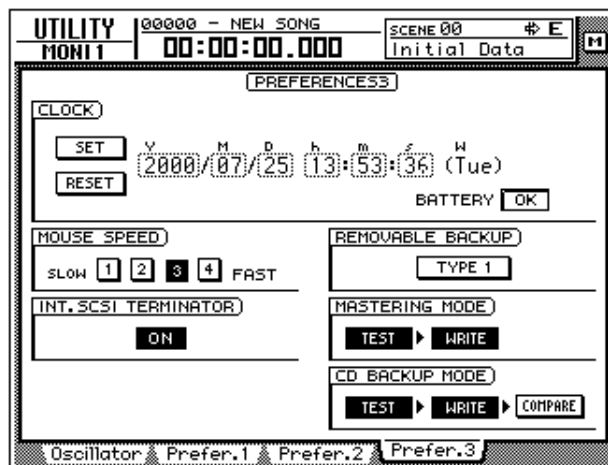

2. Move the cursor to the button in the REMOVABLE BACKUP area, and select either "TYPE1" or "TYPE2" as the backup format.
Each time you press the [ENTER] key, the button display will alternate between "TYPE1" and "TYPE2." The difference between these formats is described below.



.....
When you backup on CD-RW media, TYPE 1 will be selected as the backup format regardless of this setting. If the song being backed up will not fit on a single piece of CD-RW media, the backup can extend across multiple volumes of media.

○ TYPE1

This is the usual backup format, in which part or all of the songs are backed up using the full capacity of the removable media. This format has the advantage that even if the size of the song(s) being backed up exceeds the capacity of one volume of media, the backup can be performed using multiple volumes of media.

If this format is selected, the media will be formatted/erased automatically before backup is performed.

○ TYPE2

This backup format stores the specified song(s) or all songs as individual files on removable media. This format has the advantage that new files can be stored on a volume of media that already contains data backed up in the same format. However, it is not possible to backup data that extends across multiple volumes.

Before you can use this format to backup on newly purchased media, you must first manually format the media.

Backing up a song



- If "TYPE1" is selected as the backup format, the media will automatically be formatted before the backup is performed.
- If "TYPE2" is selected as the backup format, the media will not be formatted automatically. If necessary, you must format the media manually.
- If you are backing up on removable media such as CD-RW or MO, insert the CD-RW media or MO media into the drive before you begin this procedure.

1. Press the [FILE] key → [F1] key.

The FILE screen Backup page will appear in the display. The list in the upper part of the display shows the songs that are currently saved on the internal hard disk. The current song is highlighted in the list.

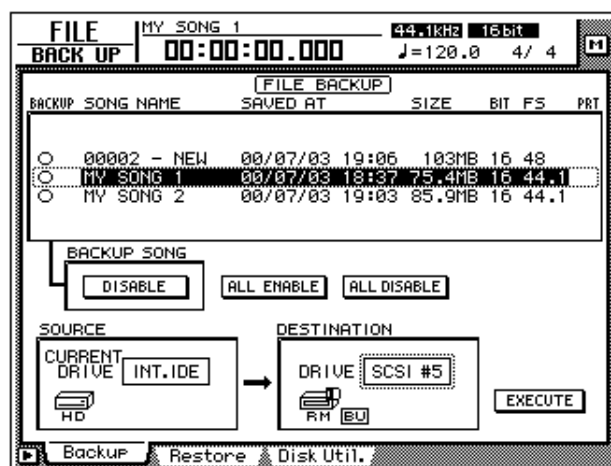

- Move the cursor to the DESTINATION area in the lower right of the display, and use the [DATA/JOG] dial to select the ID number of the backup destination SCSI device (e.g., internal CD-RW drive or external hard disk or MO drive).

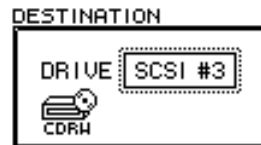

It is also possible to backup on CD-R media using an internal or external CD-RW drive. However, you should be aware that CD-R media on which a backup has been created cannot be erased or added to.

- Move the cursor to the list in the upper part of the display, and use the [DATA/JOG] dial to select the sound that you wish to backup.
- Move the cursor to the button in the BACKUP SONG area and press the [ENTER] key.

The button display will change from "DISABLE" to "ENABLE," and the song will be selected for backup. The "O" symbol at the left edge of the list will change to "●" for songs that are selected for backup.

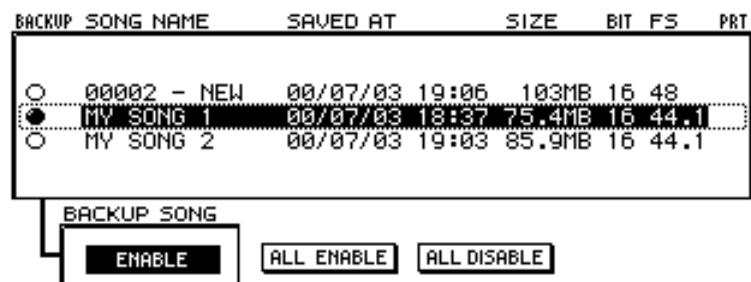

- You can repeat steps 3 and 4 to select multiple songs for backup.
- If you wish to backup all songs, move the cursor to the ALL ENABLE button located in the center of the display, and press the [ENTER] key.
- Conversely if you wish to exclude all songs from backup, move the cursor to the ALL DISABLE button and press the [ENTER] key.

- Move the cursor to the EXECUTE button in the lower right of the display, and press the [ENTER] key.

A popup window will appear, asking you to confirm the backup operation.



- To execute the backup, move the cursor to the OK button and press the [ENTER] key.

If “TYPE2” was selected as the backup format, the backup will begin immediately.

If “TYPE1” was selected as the backup format, the media will be formatted automatically (in the case of CD-RW media, all data will be erased). Then the backup will begin. If the selected song(s) will not fit on a single volume of media, a message will ask you to insert the next volume. Eject the media and insert a new volume of media.

When backing up on a hard disk or MO disk, the disk will be formatted before the backup is performed.

When backing up on a CD-RW disc, a popup window will ask you to confirm that it is OK to erase the media. Move the cursor to the OK button and press the [ENTER] key, and the media will first be erased and then the backup will be performed.



Tip!

If you decide to cancel the backup, move the cursor to the CANCEL button and press the [ENTER] key.



!

- In the case of removable media such as MO, make sure that write protect is defeated.*
- If the backup extends across multiple volumes of media, be sure to note the order of volumes on the label of the media.*
- Once backup has begun, the operation cannot be cancelled.*

Restoring a song

Here’s how data for the selected song(s) or all songs previously backed up to a SCSI device (e.g., internal CD-RW drive, or external hard disk or MO drive) can be restored to the AW4416’s internal hard disk.



!

- Before you begin, insert the disk (e.g., CD-RW or MO) containing the backed-up data into the appropriate device. If the backup extended across multiple volumes of media, make sure that the first volume of media is inserted.*
- Once the restore operation has begun, it cannot be cancelled.*

- Press the [FILE] key → [F2] key.
The FILE screen Restore page will appear in the display.
- Move the cursor to the SOURCE area in the lower left of the display, and use the [DATA/JOG] dial to select the ID number of the SCSI device on which the backup data is saved.
- Press the [ENTER] key.
The FILE RESTORE in the upper part of the display will show the song data that was backed up to the selected SCSI device.

4. Move the cursor to the FILE RESTORE area in the upper part of the display, and use the [DATA/JOG] dial to select the song(s) that you wish to restore, then press the [ENTER] key.

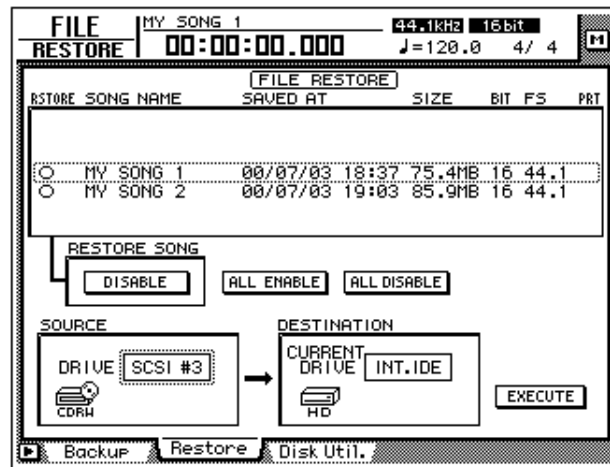

The button in the RESTORE SONG area will change from DISABLE to ENABLE, indicating that the corresponding song has been selected for restore. The “O” symbol at the left edge of the list will change to “●” for songs that are selected for restore.



.....
You can select multiple songs for restoring.

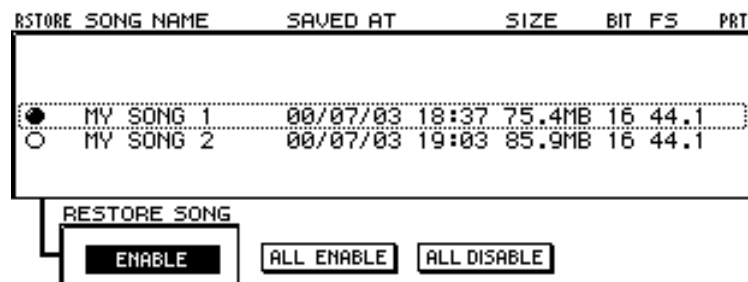

If you wish to restore all songs, move the cursor to the ALL ENABLE button in the center of the display, and press the [ENTER] key.

Conversely, if you wish to exclude all songs from the restore operation, move the cursor to the ALL DISABLE button and press the [ENTER] key.

5. Move the cursor to the EXECUTE button in the lower right of the display, and press the [ENTER] key.
A popup window will appear, asking you to confirm the restore operation.



- To execute the restore operation, move the cursor to the OK button and press the [ENTER] key.

To cancel the restore operation, move the cursor to the CANCEL button and press the [ENTER] key.



- Even when you restore from a SCSI device to the internal hard disk, the songs that were previously recorded on the internal hard disk will remain unaffected. Be aware that if songs of identical song names exist both in the backup and on the internal hard disk at this time, the internal hard disk will end up containing two identically-named songs.
- If the internal hard disk does not have sufficient free space to load the backup data, the restore operation will not be executed.

Disk utilities

This section explains the disk utility functions, such as formatting the internal hard disk or external SCSI device, and erasing CD-RW media.

Formatting the internal hard disk/external SCSI device

Here's how to format the internal hard disk/external SCSI device (hard disk, MO disk drive).



When you execute the format operation, all songs saved on the device will be lost forever. In particular, be very careful about formatting the internal hard disk. Be sure to create a backup of important song data before you proceed.

- Press the [FILE] key → [F3] key.
The FILE screen Disk Util. page will appear in the display.

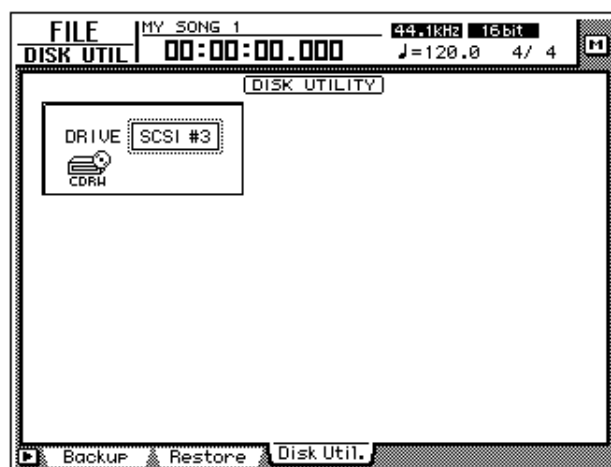

2. Rotate the [DATA/JOG] dial to select the drive that you wish to format, and press the [ENTER] key.

To format the internal hard disk, select “INT.IDE.” To format an external SCSI device, select the SCSI ID of that device.

The rest of the procedure will differ depending on the type of drive you are formatting.

□ Formatting the internal hard disk

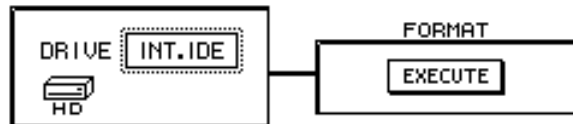

3. Move the cursor to the EXECUTE button in the FORMAT area, and press the [ENTER] key.

A popup window will appear, asking you to confirm the Format operation.



4. Move the cursor to the OK button and press the [ENTER] key.

A popup window will appear once again, asking you to confirm that you really want to format the internal hard disk.



Tip!

.....
If you decide to cancel the format operation, move the cursor to the CANCEL button and press the [ENTER] key.

5. Once again, move the cursor to the OK button and press the [ENTER] key.

Formatting will begin. When formatting of the internal disk is completed, an empty song will be created automatically, and selected as the current song.

□ Formatting an external hard disk

3. Select the SCSI ID of the external hard disk, and press the [ENTER] key.

A popup window will appear, allowing you to select the type of file system and the formatting method.

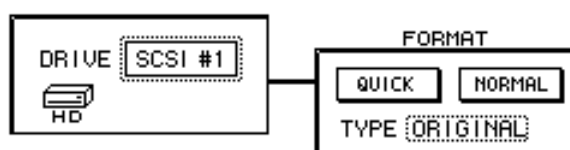

4. Move the cursor to either the QUICK or the NORMAL button, and press the [ENTER] key.

The formatting method will depend on the button you select.

○ **QUICK (quick format)**

Use this when you wish to quickly erase data from a previously-formatted hard disk.

○ **NORMAL (normal format)**

Use this when formatting a newly purchased hard disk. Depending on the capacity of the hard disk, this may require several minutes or several-ten minutes.

After selecting one or the other button, press the [ENTER] key, and a popup window will appear, asking you to confirm the Format operation.

5. Move the cursor to the TYPE area, and rotate the [DATA/JOG] dial to select one of the following two types of file system that will be created during the formatting operation.

- **ORIGINAL** This is the native file system of the AW4416. Select this file system if you have selected TYPE2 as the backup format.
- **FAT 16** This is the file system used on PC-type computers (e.g., Windows 95 or Windows 98 machines). Select this file system if you wish to exchange files with a PC.



.....
The AW4416 does not support the "FAT32" file system used on Windows 95 OSR2 and subsequent operating systems.

A popup window will appear, asking you to confirm the Format operation.



6. Move the cursor to the OK button and press the [ENTER] key. Formatting will be performed.

□ Formatting removable media such as an MO drive

A FORMAT window will appear, allowing you to select the type of file system and the formatting method.

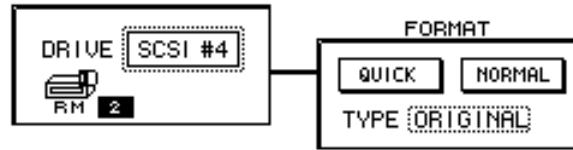

3. Move the cursor to the TYPE area, and rotate the [DATA/JOG] dial to select one of the following two types of file system that will be created during the formatting operation.
 - **ORIGINAL** This is the native file system of the AW4416. Select this file system if you have selected TYPE2 as the backup format.
 - **FAT 16** This is the file system used on PC-type computers (e.g., Windows 95 or Windows 98 machines). Select this file system if you wish to exchange files with a PC.
4. Move the cursor to either the QUICK or the NORMAL button, and press the [ENTER] key.

The formatting method will depend on the button you select.

○ QUICK (quick format)

Use this when you wish to quickly erase data from a previously-formatted MO disk.

○ NORMAL (normal format)

Use this when formatting a newly purchased MO disk. Depending on the capacity of the MO disk, this may require several minutes or several-ten minutes.

After selecting one or the other button, press the [ENTER] key, and a popup window will appear, asking you to confirm the Format operation.



5. Move the cursor to the OK button and press the [ENTER] key. Formatting will begin.

Erasing CD-RW media

Here's how to erase CD-RW media inserted in the CD-RW drive.

1. Press the [FILE] key → [F3] key.

The FILE screen Disk Util. page will appear in the display.

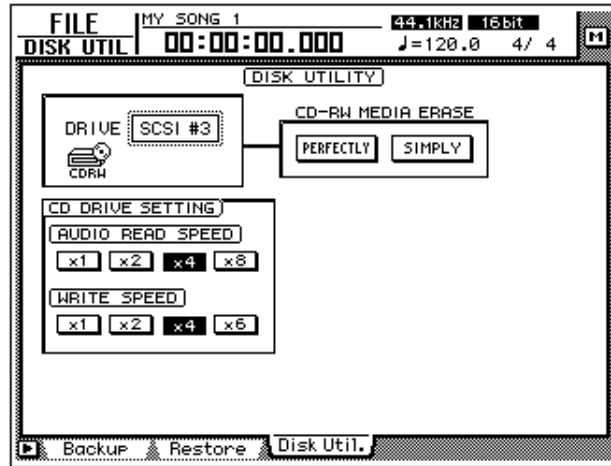

2. Use the [DATA/JOG] dial to select the SCSI ID number of the CD-RW drive, and press the [ENTER] key.
3. Use the two buttons (PERFECTLY/SIMPLY buttons) in the CD-RW MEDIA ERASE area to select the method by which the CD-RW media will be erased.

The CD-RW media can be erased in one of the following two ways.

- **PERFECTLY** All data written on the CD-RW media will be erased. This will take significantly longer than SIMPLE, but can be selected when you want to be sure that the data is completely erased.
- **SIMPLY** Only the table of contents (TOC) of the data written on the CD-RW will be erased. This method has the advantage of being fast.

Move the cursor to one of these methods and press the [ENTER] key. A popup window will ask you to confirm the erasure.

4. To execute the Erase operation, move the cursor to the OK button and press the [ENTER] key.



.....
 When you execute the Erase operation, all data that was saved on the CD-RW media will be lost forever. Please use caution.

17 Mastering

This chapter explains the “mastering function” which allows you to use the internal CD-RW drive (option) of the AW4416 to create an audio CD.

About mastering

By installing a CD-RW drive in the AW4416 (or connecting an external CD-RW drive to the SCSI connector), you can write the audio data of the stereo track (included in each song) onto CD-R/RW media in CD-DA format. This function is called “mastering.” The CD-R/RW media to which the data is written can be played back on the internal CD-RW drive or on conventional CD players in the same way as an audio CD.



.....
Some CD players and CD-ROM drives which do not support CD-R/RW may be unable to play back audio data that was written on CD-R/RW media.

Stereo tracks that can be mastered

To master a song, you will select the desired stereo track from the stereo track included in each song on the internal hard disk, and write it to a track on the CD-R/RW media. However, only stereo tracks (more than four seconds) from songs recorded as 16 bit/24 bit and a 44.1 kHz sampling frequency can be mastered.



-
- *Mastering cannot be performed from the stereo track of a song whose sampling frequency is 48 kHz.*
 - *When mastering is performed from a 24 bit/44.1 kHz stereo track, the lower 8 bits will be discarded when the data is written, converting it into 16 bit/44.1 kHz format.*

CD-R and CD-RW

CD-RW drives support two types of media: “CD-R” and “CD-RW.” These two types of media differ in the following ways.

○ CD-R

CD-R media can only be recorded or added to. Previously-recorded data cannot be erased and rewritten.

CD-R media to which audio data has been written by the AW4416’s mastering function can be played back on a CD-RW drive or on most CD players if the media has been “finalized.” Additional audio data can be recorded on CD-R media only if the disc has not yet been finalized.

○ CD-RW

CD-RW media allows previously-recorded data to be entirely erased and rewritten. (CD-RW does not allow data to be added as on a CD-R.) CD-RW media to which audio data has been written by the AW4416’s mastering function can be played back on a CD-RW drive or on some CD players. However caution is necessary, since many CD players do not support CD-RW at the present time.

The following table shows compatibility between CD-R/CD-RW media on which audio data has been recorded, and CD-RW drives and CD players.

Recording/Playback		CD-RW drives	CD players
CD-R	Disc At Once (finalized automatically)	● No silence between tracks	○ No silence between tracks
	Track At Once	● Two seconds of silence between tracks	○ Two seconds of silence between tracks
		Not finalized	× (data can be added)
CD-RW	Disc At Once (finalized automatically)	● No silence between tracks	△ No silence between tracks
	Track At Once	CD-RW media does not support Track At Once	

● : playable

○ : playable on most devices

△ : playable on some devices

× : not playable

Track At Once and Disc At Once

Data can be written to CD-R/RW media in one of the following two ways.

○ Track At Once

In this method, data is written in units of tracks (individual regions of audio data). This method can be used only for CD-R media.

When the Track At Once method is used to write data to a CD-R, approximately two seconds of silence will be created between tracks each time a track is written. Additional audio data can be recorded later on CD-R media that was written using this method.



- *In order for CD-R media written using Track At Once to be played on a CD-RW drive or on a conventional CD player, you must perform the Finalize operation to write track location data etc. on the disc after all tracks have been written.*
- *No further recording is possible on CD-R media that has been finalized.*

○ Disc At Once

This method writes the data for all tracks in one operation, and can be used for either CD-R or CD-RW media. Unlike the Track At Once method, the operation will not stop until all data has been written, meaning that there will be no silent sections between tracks.



- *CD-R/CD-RW media written using Disc At Once will automatically be finalized, and can therefore be played immediately on a CD player.*
- *No further data can be recorded on media written using Disc At Once. (However in the case of CD-RW media, you can erase all of the audio data and then rewrite.)*

Preparations for mastering

Here we will explain the preparations that you will need to make before writing audio data to CD-R/CD-RW media.

❑ Mastering mode settings

The AW4416 has a “writing test” function that checks before mastering to see whether errors will occur during data transmission. By default, the AW4416 will not perform this test before mastering, but you may perform the test if desired, or execute only the test by itself. Here’s how to make these settings.

1. Press the [UTILITY] key → [F4] key.
The UTILITY screen Prefer.3 page will appear.

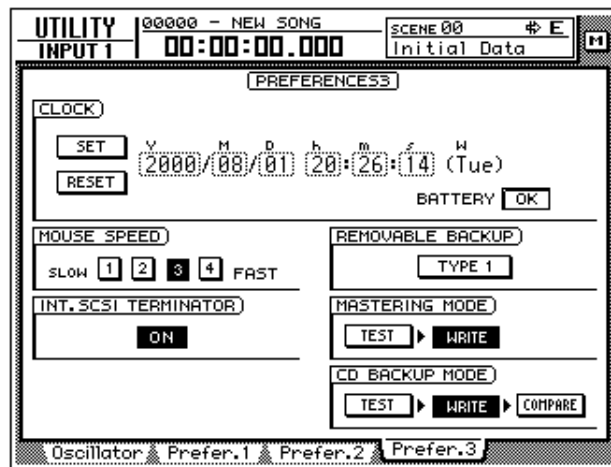

2. To perform the writing test, turn the TEST button on and the WRITE button on in the MASTERING MODE area.

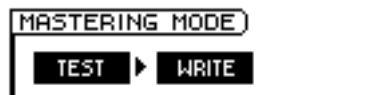

3. To execute only the writing test, turn the TEST button on and the WRITE button off in the MASTERING MODE area.

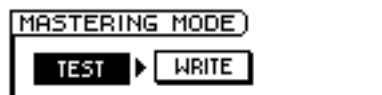

- It is not possible to turn off both the TEST and WRITE buttons.
- When writing for the first time, we recommend that you leave the TEST button on.

Writing the master

Here's how to use the mastering function to write the stereo track data to CD-R/RW media.

1. Press the [MASTERING] key.
The MASTERING screen will appear in the display.

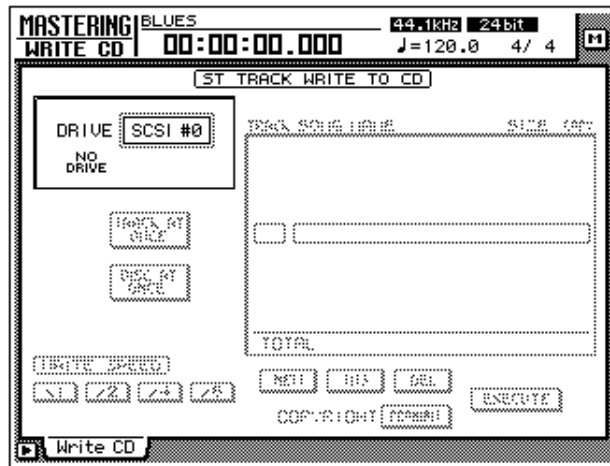

2. Hold down the [SHIFT] key and press the [F2] key (CD UNLOAD).
The tray of the CD-RW drive will open.
3. Place a CD-R/RW disc on the tray. Then hold down [SHIFT] and press the [F1] key (CD LOAD).
The tray will close.
4. Use the [DATA/JOG] dial to select the SCSI ID number of the AW4416's internal CD-RW drive, and press the [ENTER] key.

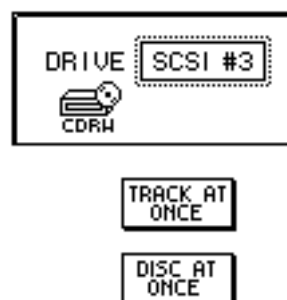

In the MASTERING screen, you can access all stereo tracks (44.1 kHz sampling frequency) saved on the internal hard disk. Thus, it is not necessary that the stereo track be part of the current song.

5. Move the cursor to the TRACK AT ONCE button if you wish to master using Track At Once, or to the DISC AT ONCE button if you wish to master using Disc At Once. Then press the [ENTER] key.

If you are using CD-RW media, only DISC AT ONCE can be used. The following screen is an example of when you have inserted CD-R media in the tray, moved the cursor to TRACK AT ONCE, and pressed the [ENTER] key.

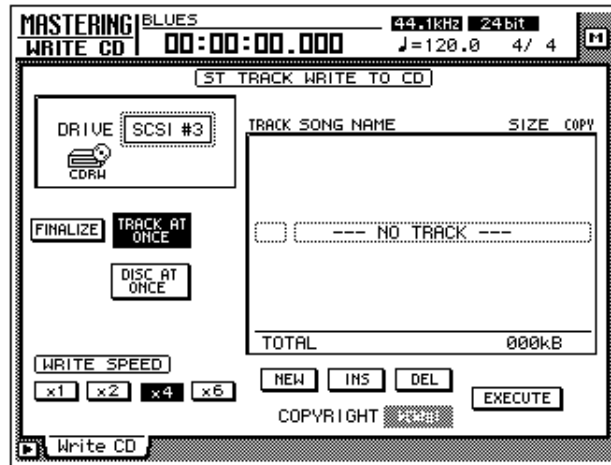

6. Move the cursor to the NEW button at the bottom of the display, and press the [ENTER] key.

The list in the right of the display will show information (the name of the song containing the stereo track, the size of the stereo track, and the copy protect setting) for the stereo track that will be written to CD audio track 1.

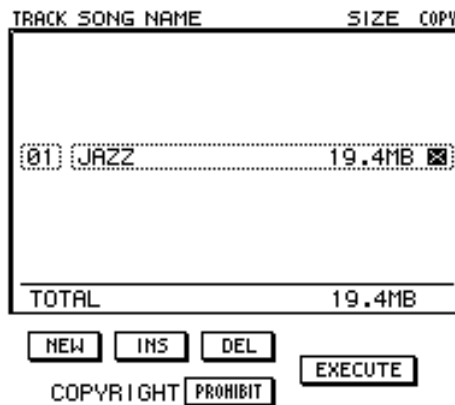

7. Move the cursor to the stereo track data area of the list, and use the [DATA/JOG] dial to select the stereo track that you wish to write to track 1 of the CD.

TRACK	SONG NAME	SIZE	COPY
01	DEMO SONG	27.3MB	☒
TOTAL		19.4MB	

NEW INS DEL EXECUTE

COPYRIGHT PROHIBIT



.....

Stereo tracks from 48 kHz songs cannot be selected in this list. Also in some cases, it may not be possible to select stereo tracks from songs for which Optimize has not been executed. To optimize a song, refer to page 182.

8. If you wish to allow digital copying of the track you selected in step 7, move the cursor to the COPYRIGHT button at the bottom of the screen, and press the [ENTER] key.

The COPYRIGHT button specifies whether copy prohibit data will be written into the subcode channel of the CD. When the button is displayed as PROHIBIT, a ☒ symbol will be displayed in the COPY column of the corresponding track, and digital copying will be prohibited for that track. If you switch the COPYRIGHT button to PERMIT, digital copying will be allowed for that track.

9. Repeat steps 5–7 to select the stereo tracks that will be written into track numbers 2 and following of the CD.

TRACK	SONG NAME	SIZE	COPY
04	BLUES 16	19.2MB	☒
03	DANCE	44.2MB	☒
02	JAZZ	19.4MB	☒
01	DEMO SONG	27.3MB	
TOTAL		77.8MB	

NEW INS DEL EXECUTE

COPYRIGHT PROHIBIT



.....

By using the DEL button at the bottom of the display, you can remove the currently selected stereo track from the list. By using the INS button, you can insert data for a new audio track into the track number that follows the currently selected track.

10. As necessary, use the WRITE SPEED buttons located in the lower left of the display to select the writing speed.

The x1/x2/x4/x6 buttons correspond to single-speed/double-speed/quad-speed/6x speed writing. Normally you should select the fastest speed that your CD-RW drive supports.



11. When you have finished selecting all of the stereo tracks that will be written to the CD, move the cursor to the EXECUTE button in the lower right of the display, and press the [ENTER] key.

A popup window will appear, asking you to confirm the operation.



12. To execute the writing operation, move the cursor to the OK button and press the [ENTER] key.

If you decide to cancel the disc writing operation, move the cursor to CANCEL and press the [ENTER] key.

After all data has been written, the media will be ejected automatically.



.....

- If Writing Test is turned on, the writing test will be executed before the actual writing begins. If a problem occurs during the test, a message will appear.
- If you write using Disc At Once, the media can be played in a CD player as soon as it is ejected.
- If you write to CD-R media using Track At Once, a popup window will ask you whether you wish to finalize the disc.

13. If you wish to execute the Finalize operation, move the cursor to the OK button and press the [ENTER] key. The CD-RW tray will close automatically, and the disc will be finalized.

If you do not wish to finalize, move the cursor to the CANCEL button and press the [ENTER] key. In this case, additional data can be recorded later on the ejected CD-R media.

Finalizing

As long as you have not executed the Finalize operation, other stereo track data can be added to CD-R media that was recorded using Track At Once. However, media that has not yet been finalized cannot be played back by a CD-RW drive or a conventional CD player. In order to use a CD player to play CD-R media on which you have written data, use the following procedure to execute the Finalize operation.

1. Press the [MASTERING] key.

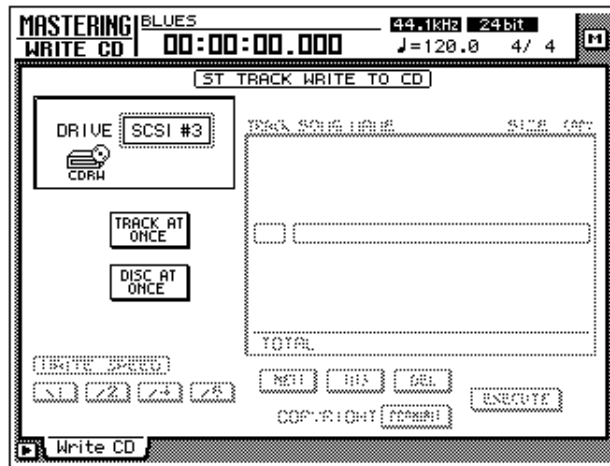

2. Place the CD-R media that you wish to finalize on the CD-RW drive tray.
3. Move the cursor to the TRACK AT ONCE button, and press the [ENTER] key.

The FINALIZE button will appear at the left of the TRACK AT ONCE button. The list in the right side of the display will show the tracks that have been written on the CD-R media.

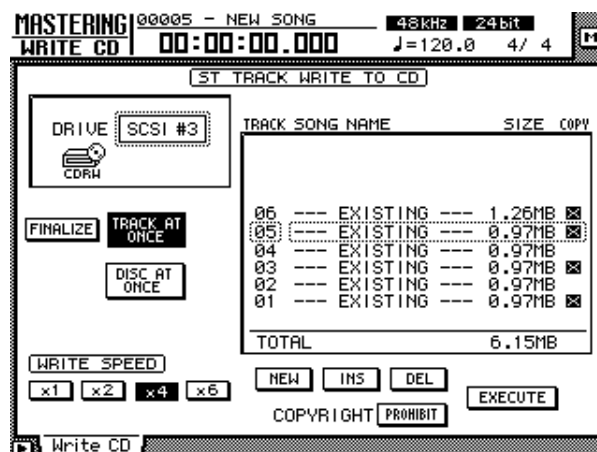

4. Move the cursor to the FINALIZE button and press the [ENTER] key. A popup window will appear, asking you to confirm the Finalize command.



5. To execute the Finalize command, move the cursor to the OK button and press the [ENTER] key. To cancel without executing, move the cursor to the CANCEL button and press the [ENTER] key.

Playing CD-R/RW media (the CD Play function)

By using the AW4416's CD Play function, CD-R/RW media that contains audio data can be played back from the internal CD-RW drive (or from an external CD-RW drive connected to the SCSI connector).

1. Press the [CD PLAY] key. The CD PLAY screen will appear in the display.

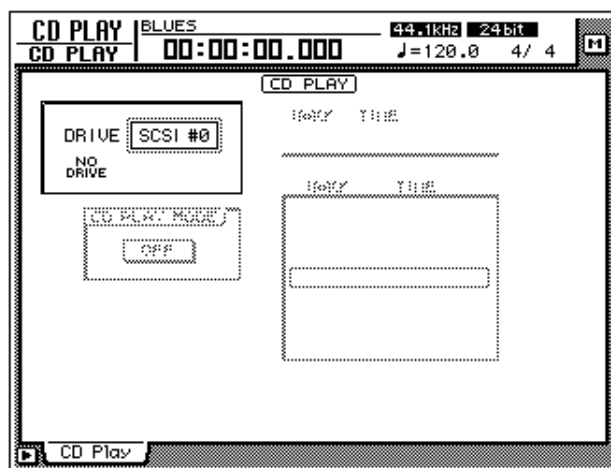

2. Use the [DATA/JOG] dial to select the SCSI ID of the CD-RW drive, and press the [ENTER] key.
3. Hold down the [SHIFT] key and press the [F2] key (CD UNLOAD). The tray of the CD-RW drive will open.
4. Place the CD-R/RW media on which data was written into the drive. Then hold down the [SHIFT] key and press the [F1] key (CD LOAD).

5. Move the cursor to the CD PLAY MODE button, and press the [ENTER] key.

The CD PLAY MODE button will change from OFF to ON, and track information for the CD-R/RW media in the drive will be displayed.

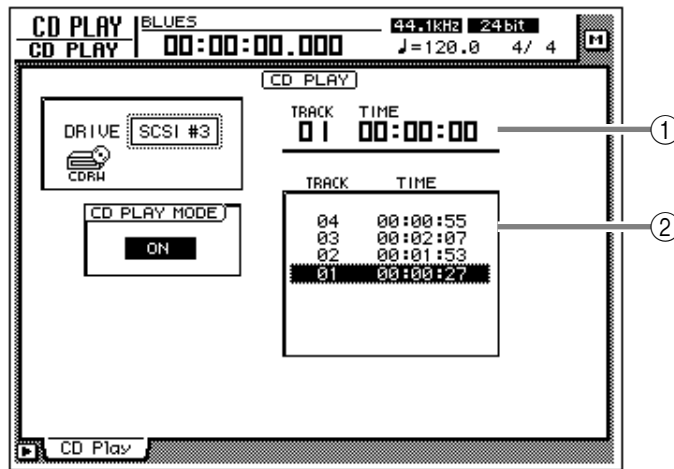

- ① Currently selected track number (TRACK column) and elapsed time (TIME column).
- ② Track numbers on the disc (TRACK column) and their track times (TIME column).



- CD-R media that has not been finalized cannot be played back.
- The counter in the level meters/counter section will not function while you are using the CD Play function.

6. Use the Locate section [⏮]/[⏭] keys to select the track that you wish to play.
7. To begin playback, press the Transport section [PLAY] key.
The audio output of the CD-RW drive will be sent directly to the stereo bus. Use the STEREO fader to adjust the volume.
8. To stop playback, press the [STOP] key.



While playback is stopped, you can press and hold the [REW]/[FF] keys to rewind or fast-forward. (However, there will be no sound.)

9. To exit the CD PLAY function, move the cursor to the CD PLAY MODE button and press the [ENTER] key.



- While the CD Play function is being used, all keys except for [⏮]/[⏭], [PLAY], [STOP], [REW]/[FF], and [ENTER] will have no effect.
- If you wish to perform other operations, turn off the CD Play function.

Index

A

- A/B point **118**
 - Deleting **126**
- A-B repeat **118**
- Active terminator **11**
- Additional function **59**
- ADP25H **2**
- Analog input/output section **31**
- Audio tracks **147**
- Auto Punch In point **130**
- Auto Punch Out Point **130**
- Auto punch-in/out **130**
 - Recording **132**
 - Rehearsing **131**
- AUTOMATION section **41**
- Automix **213**
 - Creating a new automix **214**
 - Editing off-line **225**
 - Editing the fader **223**
 - first section **216**
 - Overwriting events **219**
 - Playing back **218**
 - punch-in/out **221**
 - Recalling **230**
 - Storing **228**
- AUX buses 1–8 **28**
- AW4416
 - Features **19**
 - Signal flow **22**
 - user interface **51**

B

- Backed-up **245**
- Backup format **245**
- Buses 1–8 **28**
- Button **53, 57**

C

- CD Play function **264**
- CD-R **256**
- CD-R/RW
 - Playing **264**
- CD-RW **256**
 - Erasing media **254**

- CD-RW drive **5, 21**
 - Installation procedure **6**
 - Manual eject **10**
 - Removing the transport protection pad **9**
 - SCSI ID **5**

- Clicking **52**
- Connections **67**
- Counter **54, 54**
- Cue **110**
- Current song **75, 177**
- Cursor **52**
- CURSOR/JOG & SHUTTLE section **42**

D

- Digital cascade connections **27**
- Disc At Once **257**
- Disk utilities **250**
- Display **38, 51**
 - Contrast **39**
- Display section **38**
- Dragging **53**
- Dynamics processor **92**

E

- Effect type library **167**
- End point **117**
- EQ **91**
- External SCSI device **10**
 - Connection procedure **11**
 - Formatting **250**

F

- Fader **37, 53**
 - fader **58**
- Fader groups **101**
- Fader mode **64**
- FADER MODE section **34**
- Finalizing **263**
- Foot switch **128**
- Formatting **250**

- Formatting removable media **253**
- Front panel **50**
- Fs **76**
- Function key **56**

H

- Headphone output **30**

I

- I/O cards **13**
 - Installation procedure **14**
- IBM/PC series **233**
- Importing (mixer data) **183**
- Importing mixer data **183**
- In point **120**
- In/Out point
 - Deleting **126**
- Included items **1**
- Input channels 1–24 **24**
- Input patch **23**
- Inputting text **60**
- Internal clock **16**
- Internal effects **29, 99, 165**
 - AUX send/return **166**
 - Inserting **171**
 - library **167**
 - Patching **166, 171**
 - post-fader **169**
 - pre-fader **169**
 - return level **170**
 - send level **170**
- Internal hard disk **2**
 - Access indicator **39**
 - Formatting **250**
 - Installation **3**

K

- Knob **53, 58**

L

- LAST SOLO **97**
- Level meter/counter section **39**

Level meters **54**
 Level meters/counter **40**
 Locate point
 Adjusting the location **123**
 Deleting **125, 126**
 Locate section **43**
 Locating **114**

M

M button **52**
 Macintosh series **233**
 Make monitor settings **83, 90**
 Manual punch-in/out **128**
 recording **129**
 Marker **121**
 Deleting **126**
 Mastering **255**
 Stereo tracks that can be
 mastered **255**
 Mastering mode **258**
 MIDI **231**
 MIDI Clock **240**
 MIDI connectors **232**
 MIX SOLO **97**
 Mixdown **95**
 MIXDOWN SOLO **97**
 MIXER section **19, 33**
 MIXING LAYER section **35**
 Mixing layers **35**
 MMC **243**
 Monitor channels 1–16 **26**
 Monitor output **30**
 Mouse **52**
 MTC **54, 238**
 MTC OUT connector **232**
 Mute groups **101**
 MY4-AD **13**
 MY4-DA **13**
 MY8-AD **13**
 MY8-AE **13**
 MY8-AT **13**
 MY8-TD **13**

N

Nudge function **110**
 nudge time **112**
 play mode **112**
 Numerical box **53, 58**

O

Oscillator **27**
 Out point **120**
 Output patch **29**
 Overdubbing **87**

P

Page **56**
 Pair **80**
 PART menu **162**
 Parts **152**
 Patch library **138**
 Storing **138**
 Patch program
 Recalling **139**
 Patching **133**
 input channels **133**
 insert I/O point **140**
 outputs **136**
 recorder inputs **135**
 Pointer **52**
 PORT SELECT parameter **234**
 Post-roll time **130**
 Pre-roll time **130**
 Program changes **235**
 Punch-in/out **127**

Q

Quantization **76**
 Quick Rec function **143**

R

Rear panel **46**
 Recbit **76**
 Recorder input patching **26**
 RECORDER section **20, 40**
 RECORDING SOLO **97**
 Recording the first tracks **78**
 Region **152**
 Naming **155**
 REGION menu **163**
 Return channels 1/2 **25**
 Review **110**
 Rollback function **113**

S

Sampling frequency **76**
 Sampling pad **185**
 Assigning a region **187**
 Assigning to channels **186**
 Copying a performance **198**
 Erasing a performance **201**
 Erasing a sample **194**
 Erasing name **194**
 Naming **193**
 Recording your performance
 196
 SAMPLING PAD section **21, 45**
 Scene **203**
 Changing the order **209**
 name **207**
 Parameters included in a scene
 203
 Protecting **208**
 Recalling **206, 212**
 Saving **105**
 scene numbers **203**
 Storing **204, 211**
 Switching scenes from an
 external device **235**
 SCENE MEMORY section **41**
 SCSI errors **12**
 Selecting channels **63**
 Set the input level **78, 87**
 Shut-down **17**
 Shuttle function **110**
 Simultaneously playable tracks
 147
 Simultaneously recordable tracks
 147
 Solo **96**
 Song **175**
 Backing up **246**
 comment **179**
 Copying **181**
 Creating songs **75**
 Deleting **180**
 Loading **178**
 name **179**
 Optimizing **182**
 Restoring **248**
 Saving **106, 177**
 Start point **117**
 Stereo output channel **27**
 Stereo track **102, 148**
 Synchronize a MIDI sequencer
 238, 240

T

- Tab **53**
- Terminator **11**
- Text input box **61**
- Text palette **61**
- TO HOST connector **232**
- Top panel **31**
- Track **152**
 - Editing **152**
 - editing **156**
 - Editing command **161**
 - mix balance **95**
 - Pairing **151**
 - record-ready mode **82, 89**
 - stereo track **102**
 - track structure **147**
- Track At Once **257**
- TRACK menu **161**
- Transport key **109**
- Transport section **44**
- Trimming a sample **190**
- Turning the power off **17**
- Turning the power on **15**

U

- UNIT section **32**

V

- Virtual tracks **148**
 - Editing **152**
 - editing **159**
 - Naming **153**
 - Switching virtual tracks **149**

W

- Word clock **54, 68**
- WORK NAVIGATE section **32**

Z

- zero relative time **115**

