

YAMAHA

PORTATONE

PSR-500M

Owner's Manual

Congratulations!

You are the proud owner of a Yamaha PSR-500M. Your PSR-500M is a high-quality musical instrument that incorporates advanced Yamaha digital technology and many versatile features. In order to obtain maximum performance and enjoyment from your PSR-500M, we urge you to read this Owner's Manual thoroughly while trying out the various features described. Keep the Owner's Manual in a safe place for later reference.

CONTENTS

HOW TO USE THE MANUAL	1	AUTO ACCOMPANIMENT	16
NOMENCLATURE	2	STYLE SELECT	16
PREPARATION	4	ACCOMPANIMENT CONTROL	16
Power Supply	4	THE SINGLE FINGER MODE	18
Using Headphones Or		THE FINGERED MODE	18
An External Sound System	5	ORCHESTRATION	19
The Foot Pedal	5	CUSTOM STYLE	19
The Music Stand	5	VOICE	21
QUICK OPERATION GUIDE	6	VOICE SELECT	21
Select & Play Voices	6	THE SPLIT MODE	23
Add Reverb	6	REVERB DEPTH	23
The Split Mode —		VOLUME	23
Play Different Left- And Right Hand Voices	7	OCTAVE	24
The Dual Voice Mode —		PAN	24
Play Two Voices Across The Entire Keyboard	7	MIDI CHANNEL	24
Play With Auto Accompaniment	8	DUAL VOICE	24
Play With Auto Harmony	9	AUTO HARMONY	25
FEATURE REFERENCE	10	VOICE MEMORY	25
OVERALL CONTROL	10	SONG MEMORY	26
POWER Button	10	RECORDING A MELODY	26
MODE	10	RECORDING A CHORD SEQUENCE	28
DSP (Digital Sound Processing)	11	MELODY AND CHORD PLAYBACK	29
MASTER VOLUME	11	THE CONDUCTOR	30
ACCOMPANIMENT VOLUME	11	THE MULTI PADS	31
PITCH BEND	11	MIDI	32
TRANPOSE	12	RECEIVE CHANNEL/CLOCK	32
TUNING	12	MODE	32
TEMPO	12	System Exclusive Reception	33
SPLIT POINT CHANGE	13	Transmitted Data	34
PAGE MEMORY	13	DEMO	35
		APPENDIX A: MIDI BASICS	36
		APPENDIX B: POLYPHONY	37
		APPENDIX C: TROUBLESHOOTING	38
		APPENDIX D: MAINTENANCE	38
		APPENDIX E: SYSTEM RESET	39
		SPECIFICATIONS	39
		INDEX	40

HOW TO USE THE MANUAL

This owner's manual is divided into three main sections:

● **PREPARATION** [page 4]

This section outlines the first things you must do before playing the PSR-500M. Including power supply setup and external connections.

● **QUICK OPERATION GUIDE** [page 6]

The QUICK OPERATION GUIDE provides simplified operation procedures for several of the PSR-500M's main features. Each step includes a page number in the "FEATURE REFERENCE" section on which you can find full details about the corresponding control or feature.

● **FEATURE REFERENCE** [page 10]

This section provides full details on all PSR-500M features and controls. The features are organized in the same way as they are on the PSR-500M panel — in functional groups such as "OVERALL CONTROL," "AUTO ACCOMPANIMENT," "VOICE," etc.

Start with the "PREPARATION" section to ensure that you set up your PSR-500M properly. Then try out the basic features outlined in the "QUICK OPERATION GUIDE," referring to the page numbers given if you need more information. Refer to the "FEATURE REFERENCE" section whenever you need detailed information about a control or feature. The manual has an INDEX at the back which you can use to quickly locate information about specific features. The "NOMENCLATURE" section which follows also provides page numbers on which details about each control can be found.

The Appendices

In addition to the three main sections described above, the manual has five appendices containing general information about MIDI, polyphony, troubleshooting, maintenance, and system reset.

NOMENCLATURE

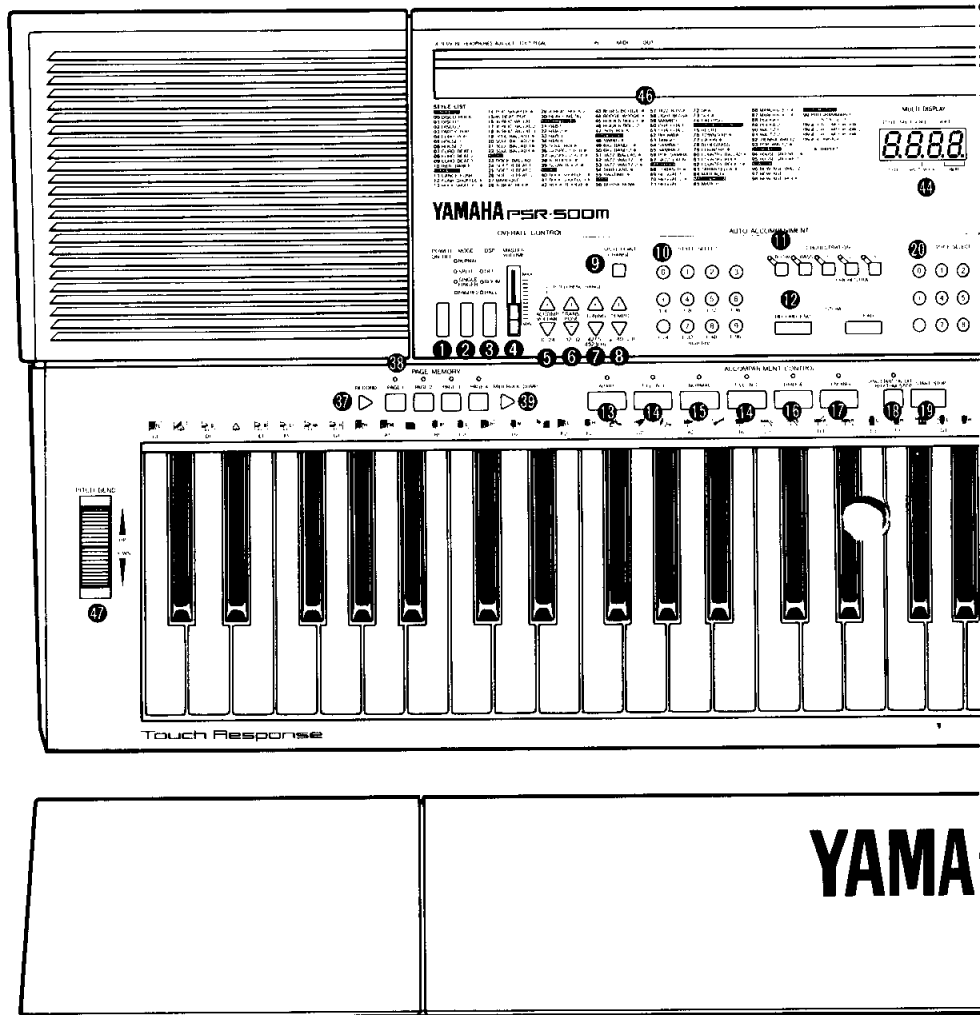

Top Panel Controls

■ OVERALL CONTROL

- ① [POWER] Buttonpage 10
- ② [MODE] Buttonpage 10
- ③ [DSP] Buttonpage 11
- ④ [MASTER VOLUME] Controlpage 11
- ⑤ [ACCOMP. VOLUME/PITCH BEND RANGE] Buttonspage 11, 12
- ⑥ [TRANSPOSE] Buttonspage 12
- ⑦ [TUNING] Buttonspage 12
- ⑧ [TEMPO] Buttonspage 12
- ⑨ [SPLIT POINT CHANGE] Buttonpage 13

■ PAGE MEMORY

- ⑳ [RECORD] Buttonpage 13
- ㉑ [PAGE 1] through [PAGE 4] Buttonspage 13
- ㉒ [MIDI BULK DUMP] Buttonpage 15

■ AUTO ACCOMPANIMENT

- ⑩ Numeric STYLE SELECT Buttonspage 16

- ⑪ ORCHESTRATION Buttons: [RHYTHM], [BASS], [ORCHESTRA 1], [ORCHESTRA 2], and [ORCHESTRA 3]page 19

- ⑫ CUSTOM [RECORD/END] and [CLEAR] Buttonspage 19

■ ACCOMPANIMENT CONTROL

- ⑬ [INTRO] Buttonpage 17
- ⑭ [FILL IN 1] and [FILL IN 2] Buttonpage 17
- ⑮ [NORMAL] Buttonpage 17
- ⑯ [BRIDGE] Buttonpage 17
- ⑰ [ENDING] Buttonspage 17
- ⑱ [SYNC-START ON/OFF — RHYTHM STOP] Buttonpage 16
- ⑲ [START/STOP] Buttonpage 16

■ VOICE

- ㉑ Numeric VOICE SELECT Buttonspage 21
- ㉒ AUTO HARMONY [ON/OFF] and [TYPE] Buttonspage 25
- ㉓ [DUAL VOICE] Buttonpage 24

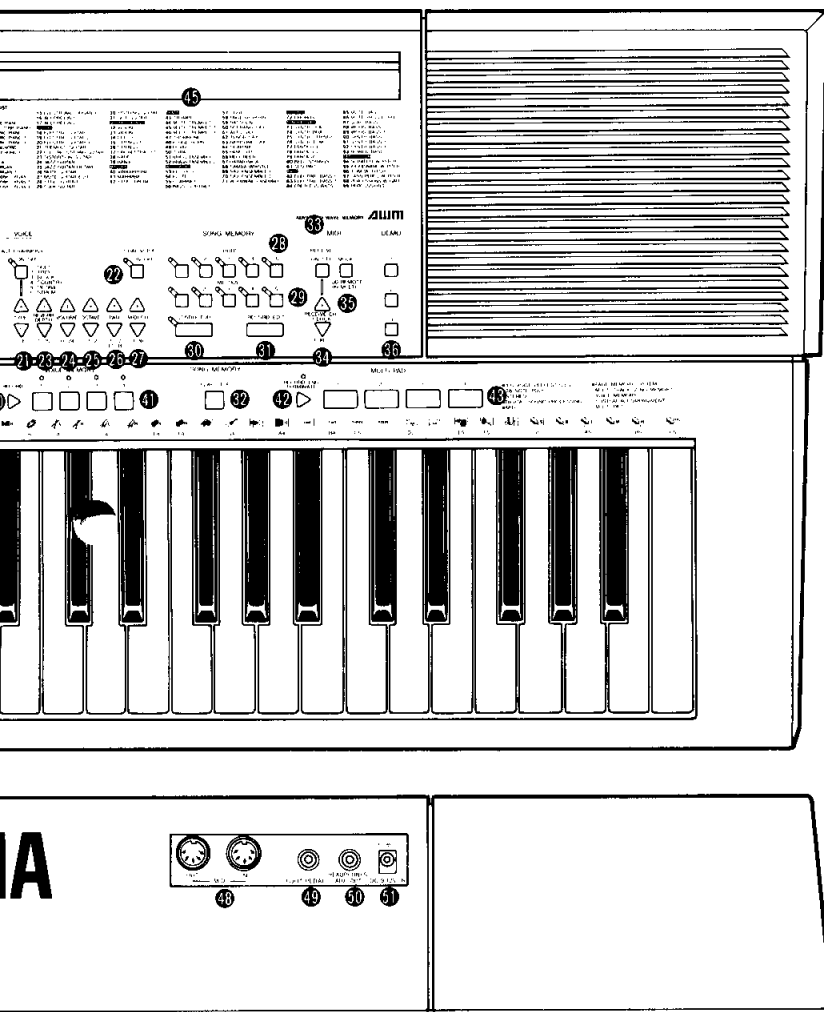

22	[REVERB DEPTH] Buttons	page 23
23	[VOLUME] Buttons	page 23
25	[OCTAVE] Buttons	page 24
26	[PAN] Buttons	page 24
27	[MIDI CH.] Buttons	page 24
■ VOICE MEMORY			
40	[RECORD] Button	page 25
41	[1] through [4] Buttons	page 25
■ SONG MEMORY			
28	[CHORD 1] through [CHORD 5] Buttons	page 28
29	[MELODY 1] through [MELODY 5] Buttons	page 26
30	[CONDUCTOR] Button	page 30
31	[RECORD/EDIT] Button	page 26
32	[PLAY/STOP] Button	page 27
■ MIDI			
33	[RECEIVE ON/OFF] Button	page 32
34	[RECEIVE CH./CLOCK] Buttons	page 32
35	[MODE] Button	page 32

■ DEMO			
36	DEMO Buttons [1] through [3]	page 34
■ MULTI PAD			
42	[RECORD/END (TERMINATE)] Button	page 31
43	[1] through [4] Buttons	page 31
■ OTHERS			
44	MULTI DISPLAY	page 4
45	VOICE LIST	page 21
46	STYLE LIST	page 16
47	PITCH BEND WHEEL	page 11

Rear Panel Connectors

48	MIDI IN and OUT Connectors	page 36
49	FOOT PEDAL Jack	page 5
50	HEADPHONES/AUX. OUT Jack	page 5
51	DC IN Jack	page 4

PREPARATION

This section contains information about setting up your PSR-500M and preparing to play. Be sure to go through this section carefully before using your PSR-500M.

POWER SUPPLY

Your PSR-500M will run either from the supplied power adaptor or optional batteries*. Follow the instructions below according to the power source you intend to use.

* When batteries are used the sound of the PSR-500M may be distorted at high volume levels. This is because the power of the amplifier is reduced when batteries are used.

CAUTION!

Never interrupt the power supply (e.g. remove the batteries or unplug the AC adaptor) during any PSR-500M record operation! Doing so can result in a loss of data.

Using the Supplied AC Power Adaptor

Plug the DC output cable from the supplied Yamaha PA-5 AC Power Adaptor into the DC IN jack on the rear panel of the PSR-500M, then plug the AC cable of the Power Adaptor into a convenient wall AC power socket.

The internal batteries are automatically disconnected when an AC Power Adaptor is used.

• Use **ONLY** a Yamaha PA-5 AC Power Adaptor to power your instrument from the AC mains. Other adaptors may be damaged by use with the PSR-500M, and they may even cause serious damage to your PSR-500M.

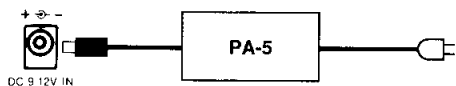

Using Batteries (sold separately)

Six 1.5V SUM-1, "D" size, R-20 or equivalent batteries must first be installed in the battery compartment, as follows:

1. Open the battery compartment cover located on the instrument's bottom panel and remove the old batteries.
2. Insert the six new batteries, being careful to follow the polarity markings on the inside of the compartment.
3. Replace the compartment cover, making sure that it locks firmly in place.

When the batteries need to be replaced, "batt" will appear on the MULTI DISPLAY. When this display appears the PSR-500M will not operate, and the power must be turned off while either the batteries are replaced or an AC adaptor is connected.* Internal data will be retained for up to about 10 minutes while the batteries are changed or an AC adaptor is connected.

* If fresh batteries or an AC adaptor are not immediately available, it may be possible to use the PSR-500M for a little while longer by turning the power off and then on again, and playing at a low volume setting.

Caution:

1. When the batteries run down, replace them with a complete set of six new batteries. NEVER mix old and new batteries.
2. Do not use different kinds of batteries at the same time.
3. To prevent possible damage due to battery leakage, remove the batteries from the instrument if it is not to be used for an extended period of time.

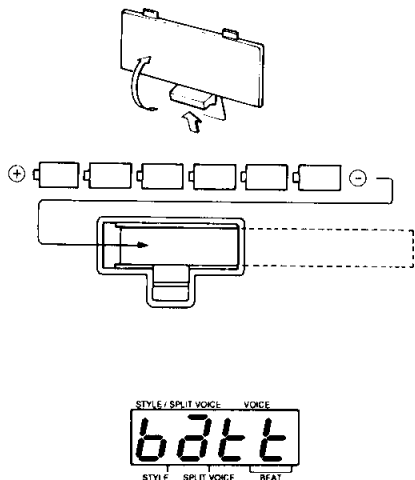

USING HEADPHONES OR AN EXTERNAL SOUND SYSTEM

A standard pair of stereo headphones can be plugged into the rear-panel HEADPHONES/AUX. OUT jack for private practice or late-night playing. The internal speaker system is automatically shut off when a pair of headphones is plugged into the HEADPHONES jack. The HEADPHONES/AUX. OUT jack can also be used to deliver the output of the PSR-500M to a keyboard amplifier, stereo sound system, mixing console or tape recorder.

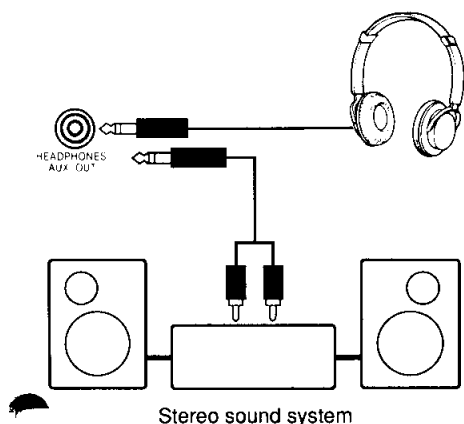

THE FOOT PEDAL

Plug the supplied foot pedal into the rear-panel FOOT PEDAL jack. The foot pedal functions as a damper pedal, controlling sustain. Press the pedal to sustain notes after the keys are released.



- Be sure that you do not press the pedal while inserting the plug into the FOOT PEDAL jack or while turning the power on. If you do, the ON/OFF status of the footswitch will be reversed. This function has been implemented to allow either press-to-make or press-to-break contact type footswitches to be used with the PSR-500M.
- Sustain cannot be applied to voices in which releasing the key played does not stop the sound: e.g. MUTE GUITAR (26), MARIMBA (41), PERCUSSIONS (99), etc.

THE MUSIC STAND

Insert the bottom edge of the music stand into the slot located at the rear of the PSR-500M control panel.

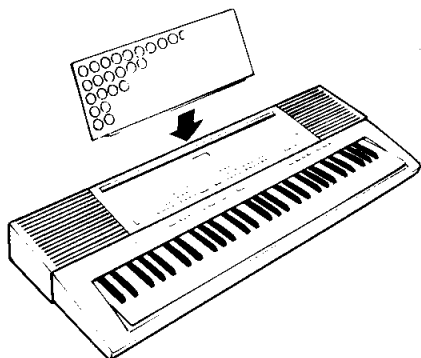

QUICK OPERATION GUIDE

This section provides brief outlines of the procedures for operating several of the most basic PSR-500M features. Refer to the page numbers listed for details about each feature and more advanced capabilities.

SELECT & PLAY VOICES

VOICE SELECT

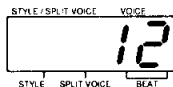
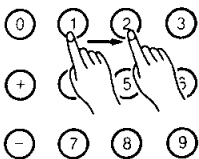

1. Use the VOICE SELECT buttons to select a voice [page 21].



2. Use the MASTER VOLUME control to set the overall volume [page 11].

3. Play.

ADD REVERB

DSP

- OFF
- ROOM
- HALL

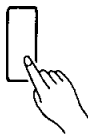

1. Use the [DSP] button to select the HALL or ROOM reverb type [page 11].

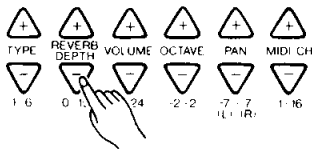

2. Use the [REVERB DEPTH] button to set the depth of the selected reverb effect for the current voice [page 23].

THE SPLIT MODE PLAY DIFFERENT LEFT- AND RIGHT- HAND VOICES

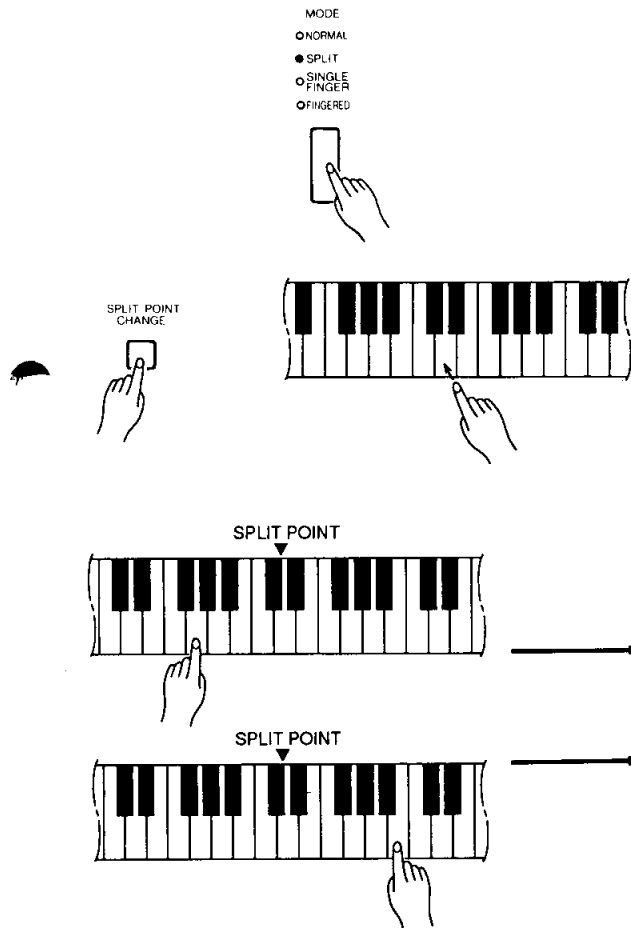

1. Use the [MODE] button to select the SPLIT mode [page 10].
2. Use the [SPLIT POINT CHANGE] button to change the split point, if necessary [page 13].
3. Use the VOICE SELECT buttons to select the left-hand and right-hand voices [page 23].
Press a left-hand key before selecting the left-hand voice and a right-hand key before selecting the right-hand voice.

THE DUAL VOICE MODE PLAY TWO VOICES ACROSS THE ENTIRE KEYBOARD

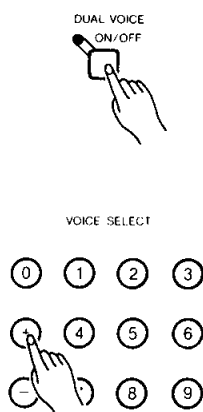

1. Use the VOICE SELECT buttons to select a voice [page 21].
2. Press the [DUAL VOICE] button to engage the DUAL VOICE mode [page 24].
3. Use the VOICE SELECT buttons to select the second “dual” voice [page 24].
4. Play.

PLAY WITH AUTO ACCOMPANIMENT

MODE
 ○ NORMAL
 ○ SPLIT
 ● SINGLE FINGER
 ○ FINGERED



1. Use the [MODE] button to select the SINGLE FINGER or FINGERED mode [page 10].

SPLIT POINT CHANGE

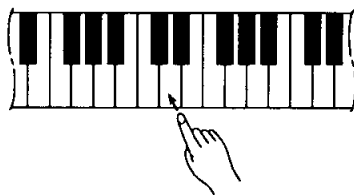

2. If necessary, use the [SPLIT POINT CHANGE] button to set the split point [page 13].

STYLE SELECT

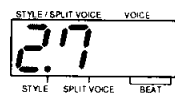
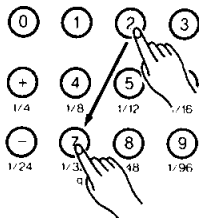

3. Use the STYLE SELECT buttons to select the desired accompaniment style [page 16]. You can also select a melody (upper keyboard) voice via the VOICE SELECT buttons [page 21].

4. Use the ACCOMPANIMENT CONTROL buttons to determine how the accompaniment will be started [page 16], then press the [SYNC-START ON/OFF] button to engage the synchronized start mode [page 16].

ACCOMPANIMENT CONTROL

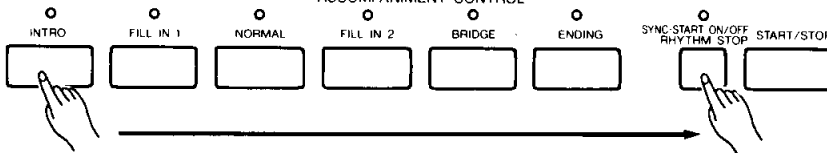

5. Press any key or play a chord to the left of the split point to start the automatic accompaniment — play using either SINGLE FINGER or FINGERED type fingering according to the selected mode [page 10].

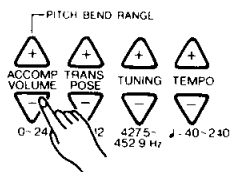

6. Use the [ACCOMP. VOLUME] buttons to adjust the volume of the accompaniment sound [page 11].

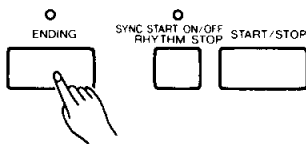

7. Use the ACCOMPANIMENT CONTROL section [START/STOP] or [ENDING] button to stop the accompaniment [page 17].

PLAY WITH AUTO HARMONY

- MODE
- NORMAL
 - SPLIT
 - SINGLE FINGER
 - FINGERED

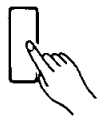

1. Use the [MODE] buttons to select the SPLIT, SINGLE FINGER, or FINGERED mode [page 10].

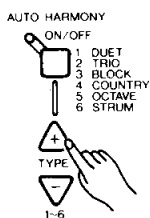

2. Use the AUTO HARMONY TYPE buttons to select a harmony type between "1" and "6" [page 25].

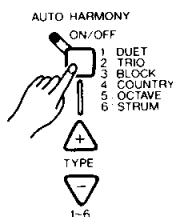

3. Press the [AUTO HARMONY ON/OFF] button so that its indicator lights [page 25].

4. Play chords on the left-hand section of the keyboard while playing a melody on the right-hand section of the keyboard [page 25].

FEATURE REFERENCE

The "FEATURE REFERENCE" provides full details on each of the PSR-500M features. The features are presented as they appear on the PSR-500M panel, organized into functional groups such as "OVERALL CONTROL," "AUTO ACCOMPANIMENT," and "VOICE." To find information about a particular control or feature, either go directly to the section in which that control or feature is found, or look up the name of the control or feature in the index at the end of the manual.

OVERALL CONTROL

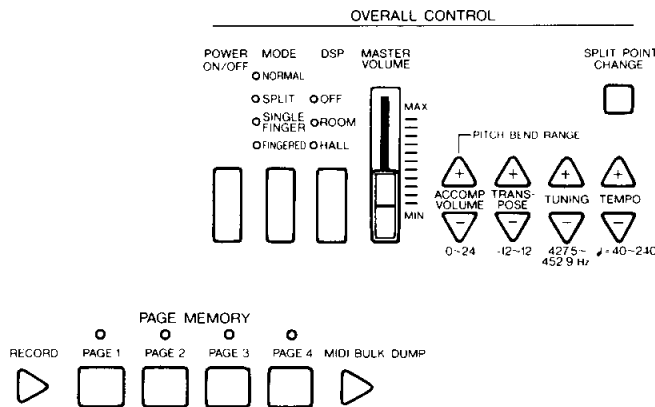

● POWER Button

Press the [POWER] button to turn the power on or off.

POWER ON/OFF

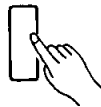

Auto Power OFF

To prevent unnecessary battery drainage, the PSR-500M features an Auto Power OFF function that automatically turns the power OFF if the instrument is not used — i.e. no buttons or keys are pressed or no automatic features are operating — for approximately 10 minutes.

The Auto Power OFF function does not operate when the PSR-500M is powered from the AC Power Adaptor.

● MODE

The [MODE] button determines the operational mode of the PSR-500M. Press the [MODE] button as many times as necessary until the indicator corresponding to the desired mode lights:

MODE
● NORMAL
○ SPLIT
○ SINGLE FINGER
○ FINGERED

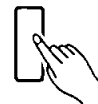

• NORMAL

This is the normal mode of operation in which you can select and play a single voice (or two voices if the DUAL VOICE function is used), and select styles for rhythm-only accompaniment.

• SPLIT

In this mode different voices can be selected for the left- and right-hand sections of the keyboard. See page 23 for details.

• SINGLE FINGER

This mode provides automatic rhythm, bass, and orchestra accompaniment that you can control by playing just one, two, or three keys in the left-hand section of the keyboard. See page 18 for details.

• FINGERED

The FINGERED mode provides automatic rhythm, bass, and orchestra accompaniment based on chords you play in the left-hand section of the keyboard. See page 18 for details.

● DSP (Digital Sound Processing)

The [DSP] button provides two digital effects that you can use for extra depth and expressive power. This button determines the type of effect to be used, while the REVERB DEPTH controls in the VOICE section allow the depth of the effect to be individually set for each voice — including the left- and right-hand split voices, and the main and sub dual voices.

Each time the [DSP] button is pressed the next effect is selected and the corresponding indicator will light. No effect is selected when the OFF indicator is lit.

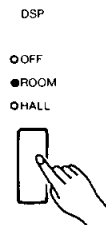

OFF

No effect is produced.

ROOM

This setting adds a reverb effect to the sound that is similar to the type of acoustic reverberation you would hear in a room.

HALL

For a spacious reverb sound, use the HALL setting. This effect simulates the natural reverberation of a concert hall.

- Almost all of the auto accompaniment styles are programmed to use the DSP effects, but no effect will be produced if DSP is set to OFF.

● MASTER VOLUME

Use the MASTER VOLUME control to adjust the overall volume of the PSR-500M — including the sound of the voices being played, auto accompaniment, song memory playback, etc.

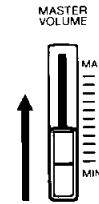

● ACCOMPANIMENT VOLUME

Although the MASTER VOLUME control can be used to set the overall volume level, the ACCOMPANIMENT VOLUME [▲] and [▼] buttons can be used to adjust the volume of the selected accompaniment in relation to the right-hand melody voice. Press the [▲] button to increase the volume, or the [▼] button to decrease the volume. The selected volume level will be displayed on the MULTI DISPLAY while the volume is being adjusted, and for approximately 2 seconds after either VOLUME button is released.



The volume range is from 0 to 24. A setting of 0 produces no sound while 24 is the highest volume level. The default accompaniment volume value (21) can be recalled at any time by pressing both the ACCOMPANIMENT VOLUME [▲] and [▼] buttons at the same time.

- When this parameter has been changed, be sure to store the new data to a PAGE MEMORY (see page 13). If this is not done the newly selected data will be lost when a different PAGE MEMORY is selected.

● PITCH BEND

The PITCH BEND wheel to the left of the keyboard allows the pitch notes to be bent up or down — roll the wheel away from you to bend up, and toward you to bend down (this situation can be reversed, as described below). When the PITCH BEND wheel is moved almost all the way in either direction, the current pitch bend range value will appear on the MULTI DISPLAY (see below).

Setting the Pitch Bend Range

The maximum amount of pitch bend produced by the PITCH BEND wheel can be set anywhere from ± 1 semitone to ± 12 semitones (i.e. plus or minus one octave).

- To set the pitch bend range, roll the PITCH BEND wheel all the way in either direction so that the current range value appears on the MULTI DISPLAY.

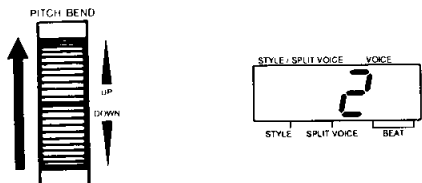

- Use the ACCOMP. VOLUME (PITCH BEND RANGE) [▲] and [▼] buttons to set the desired range — the pitch bend range value is displayed in semitones (-12 through 12). If a minus setting is selected pitch bend wheel operation is reversed — i.e. roll the wheel away from you to lower pitch.

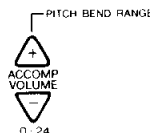

- Release the PITCH BEND wheel.

- When this parameter has been changed, be sure to store the new data to a PAGE MEMORY (see page 13). If this is not done the newly selected data will be lost when a different PAGE MEMORY is selected.

TRANSPOSE

The PSR-500M [TRANSPOSE] buttons makes it possible to shift the pitch of the PSR-500M up or down in semitone intervals up to a maximum of 12 semitones (one octave). Transposing the pitch of the PSR-500M keyboard makes it easier to play in difficult key signatures, and you can simply match the pitch of the keyboard to the range of a singer or other instrumentalist.

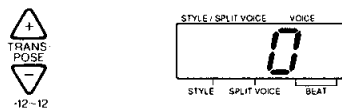

The TRANSPOSE [▲] and [▼] buttons are used for transposition. Press the [▲] button to increase the pitch of the keyboard, or the [▼] button to lower the pitch. The selected degree of transposition will be displayed on the center two digits of the MULTI DISPLAY while the TRANSPOSE [▲] or [▼] button is pressed, and for approximately 2 seconds after either TRANSPOSE button is released.

The transposition range is from -12 to +12, with -12 corresponding to downward transposition by 12 semitones (one octave), and +12 corresponding to upward transposition by 12 semitones. 0 is the "normal" keyboard pitch value. The normal transpose value (0) can be recalled at any time by pressing both the TRANSPOSE [▲] and [▼] buttons at the same time.

- The TRANSPOSE function will not work while any keys are held.
- TRANSPOSE does not affect the percussion voices (numbers 94 through 99).
- When this parameter has been changed, be sure to store the new data to a PAGE MEMORY (see page 13). If this is not done the newly selected data will be lost when a different PAGE MEMORY is selected.

TUNING

The PSR-500M [TUNING] buttons makes it possible to tune the pitch of the PSR-500M to match other instruments. Tuning can be accomplished over a ± 50 -cent range (that's 100 cents total, or one semitone) in 16 steps.



The TUNING [▲] and [▼] buttons are used for tuning. Press the [▲] button to raise the pitch of the instrument, or the [▼] button to lower the pitch. The selected degree of tuning will be shown on the MULTI DISPLAY in Hertz while the TUNING [▲] or [▼] button is pressed, and for approximately 2 seconds after either TUNING button is released.

The tuning range is from 427.5 Hertz (-50 cents) to 452.9 Hz (+50 cents). 440.0 Hertz (± 0 cents) is the "normal" tuning value. The normal tuning value (440.0) can be recalled at any time by pressing both the TUNING [▲] and [▼] buttons at the same time.

- TUNING does not affect the percussion voices (numbers 94 through 99).
- When this parameter has been changed, be sure to store the new data to a PAGE MEMORY (see page 13). If this is not done the newly selected data will be lost when a different PAGE MEMORY is selected.

TEMPO

The TEMPO buttons control the tempo of the AUTO ACCOMPANIMENT, the SONG MEMORY, DEMO playback, and the MULTI PADS.

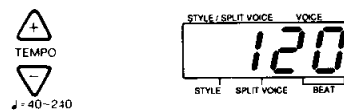

Press the TEMPO [▲] button to increase the tempo, or the TEMPO [▼] button to decrease the tempo. The selected tempo will be displayed on the MULTI DISPLAY (in quarter-note beats per minute) while the TEMPO [▲] or [▼] button is pressed, and for approximately 2 seconds after either TEMPO button is released.

The available tempo range is from 40 to 240 beats per minute. Each accompaniment style has a different “default” tempo which is automatically set whenever a new style is selected (but not when a new style is selected while the accompaniment is playing). The default tempo for the currently selected accompaniment style can be recalled at any time by pressing both the TEMPO [▲] and [▼] buttons at the same time.

SPLIT POINT CHANGE

Separate split points can be set for the SPLIT, FINGERED, and SINGLE FINGER modes. The default split point settings are as follows:

- SPLIT mode: C#3
- SINGLE FINGER mode: D2
- FINGERED mode: G2

The split point for each mode can be set to any other key while that mode is selected by pressing the desired split-point key while holding the [SPLIT POINT CHANGE] button.

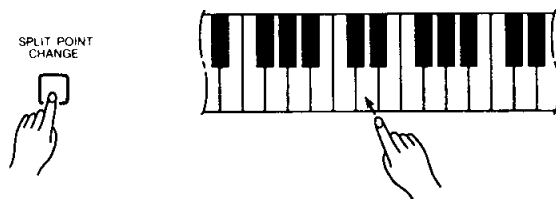

The split point is shown on the MULTI DISPLAY for as long as the [SPLIT POINT CHANGE] button is held. The C3 key, for example, would be displayed as “c 3”. F#2 would be displayed as “F 2”. The sharp is indicated by the lit bar between the “F” and the “2.”

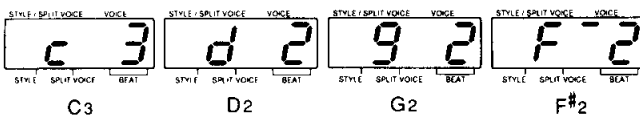

The SPLIT, SINGLE FINGER, and FINGERED mode split points are retained in memory and will be recalled whenever the corresponding mode is selected.

Note that the split-point key is included in the right-hand section of the keyboard.

- When this parameter has been changed, be sure to store the new data to a PAGE MEMORY (see next paragraph). If this is not done the newly selected data will be lost when a different PAGE MEMORY is selected.

PAGE MEMORY

The PAGE MEMORY can be used to store 4 complete sets of panel settings (including the contents of the SONG MEMORY and MULTI PAD features) that can then be recalled simply by pressing a single button.

When the power is initially turned on the previously selected “PAGE” is automatically selected and its indicator will light. If any changes are then made to the panel settings the PAGE indicator will flash, indicating that changes have been made. If the same PAGE button is then pressed the original PAGE settings will be recalled and the indicator will light continuously again.

The following panel settings are stored by the PAGE MEMORY:

- Currently selected voice(s).
 - MULTI PAD contents.
 - SONG MEMORY contents.
 - VOICE MEMORY contents.
 - VOICE section parameter settings (Auto Harmony, Reverb Depth, Volume, Octave, Pan, MIDI Out Channel, Dual).
 - CUSTOM ACCOMPANIMENT contents.
 - Currently selected STYLE.
 - Currently selected chord voice when accompaniment stopped.
 - ORCHESTRATION settings.
 - ACCOMPANIMENT CONTROL status.
 - MODE.
 - ACCOMP. VOLUME.
 - TUNE.
 - TRANSPOSE.
 - TEMPO.
 - PITCH BEND RANGE.
 - DSP
 - MIDI RECEIVE CHANNEL/CLOCK.
- * The MIDI MODE setting is not recorded by the PAGE MEMORY. MIDI MODE is reset to “00” whenever the power is turned on or a different PAGE is selected.

Recording

Make the desired panel settings, then press one of the PAGE MEMORY buttons while holding the [RECORD] button. The corresponding indicator will light indicating that the data has been memorized. All previous data in the selected PAGE will be erased.

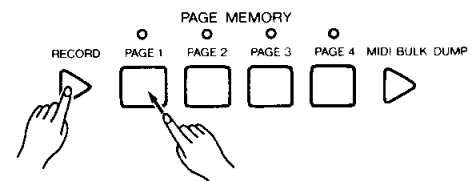

- The PAGE MEMORY cannot be recorded while any automatic playback feature or any recording function is running (AUTO ACCOMPANIMENT play; SONG MEMORY record/play/play ready; MULTI PAD record/play; CUSTOM ACCOMPANIMENT record/play, DEMO play).

FEATURE REFERENCE (OVERALL CONTROL)

Recall

To recall a PAGE MEMORY setting simply press the appropriate PAGE MEMORY button. The corresponding indicator will light and the required panel settings will be recalled.

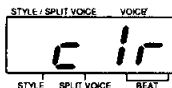

- If the panel settings are changed but not recorded (including such operations as completing a SONG MEMORY recording), those changes will be lost if a PAGE MEMORY is recalled.

- A different PAGE MEMORY cannot be selected while any automatic playback feature or any recording function is running (AUTO ACCOMPANIMENT play; SONG MEMORY record/play/play ready; MULTI PAD record/play; CUSTOM ACCOMPANIMENT record/play, DEMO play).
- If the panel settings have been changed but not recorded and the power is turned off, those panel settings will be memorized separately from the page memory.
- PAGE MEMORY data will be retained in memory even when the PSR-500M power is turned off as long as a full set of good batteries is present or an AC power adaptor remains connected.
- If no batteries are installed and no AC power adaptor is connected for more than about 10 minutes, the PAGE memory is automatically initialized when the power is turned on. Individual PAGE MEMORY banks can be initialized by holding the corresponding PAGE MEMORY button while turning the power on. All PAGE MEMORY banks can be initialized at once by holding both the CUSTOM [RECORD/END] and [CLEAR] buttons while turning the power on. In either case, "clr" appears on the MULTI DISPLAY when the memory is initialized.



The initialized settings are as follows:

List of initial PAGE memory settings

			PAGE 1 - 4		
OVERALL CONTROL	MODE DSP PITCH BEND RANGE ACCOMP. VOL TRANSPOSE TUNING		NORMAL ROOM 2 21 0 440		
	SPLIT POINT	SPLIT SINGLE FINGER FINGERED	C#3 D2 G2		
AUTO ACCOMPANIMENT	STYLE No.		00		
	ORCHESTRATION	RHYTHM BASS ORCHESTRA 1 ORCHESTRA 2 ORCHESTRA 3	ON ON ON ON ON		
	CUSTOM STYLE		PAGE 1: Style for DEMO 1 PAGE 2: Style for DEM.  PAGE 3: Style for DEMO 3 PAGE 4: LAMBADA		
	ACCOMP. CONTROL SYNCHRO START		NORMAL OFF		
	Chord Voice When Accompaniment Stopped	VOICE No. REVERB DEPTH VOLUME OCTAVE PAN	35 6 12 2 0		
VOICE	Current	LEFT	NORMAL/DUAL	NORMAL	DUAL
			VOICE No.	89	35
	REVERB DEPTH	6	6		
	VOLUME	21	16		
	OCTAVE	1	-1		
	PAN	0	0		
	MIDI CH	2			
	DUAL VOICE	OFF			
	RIGHT	VOICE No.	00	35	
	REVERB DEPTH	6	6		
VOLUME	21	16 			
OCTAVE	0	0			
PAN	0	0			
HARMONY TYPE	3				
MIDI CH	1				
DUAL VOICE	OFF				
HARMONY ON/OFF			OFF		
VOICE MEMORY 1	LEFT	VOICE No.	86	95	
		REVERB DEPTH	6	6	
		VOLUME	21	21	
	OCTAVE	1	0		
	PAN	0	0		
	MIDI CH	2			
DUAL VOICE	OFF				
RIGHT	VOICE No.	03	00		
REVERB DEPTH	6	6			
VOLUME	21	10			
OCTAVE	0	0			
PAN	0	0			
HARMONY TYPE	2				
MIDI CH	1				
DUAL VOICE	ON				
HARMONY ON/OFF			OFF		

		NORMAL/DUAL	NORMAL	DUAL	
VOICE	VOICE MEMORY 2	LEFT	VOICE No.	35	93
			REVERB DEPTH	6	14
			VOLUME	21	22
		RIGHT	OCTAVE	0	1
			PAN	0	0
			MIDI CH	2	
	DUAL VOICE		ON		
	HARMONY ON/OFF		OFF		
	VOICE MEMORY 3	LEFT	VOICE No.	56	59
			REVERB DEPTH	6	9
			VOLUME	24	21
		RIGHT	OCTAVE	1	1
			PAN	0	0
			MIDI CH	2	
	DUAL VOICE		OFF		
HARMONY ON/OFF		OFF			
VOICE MEMORY 4	LEFT	VOICE No.	30	36	
		REVERB DEPTH	8	13	
		VOLUME	24	18	
	RIGHT	OCTAVE	2	1	
		PAN	0	0	
		MIDI CH	2		
DUAL VOICE		ON			
HARMONY ON/OFF		OFF			
VOICE MEMORY 1 ~ 4			All OFF		
SONG MEMORY	CHORD 1 ~ 5		No Data		
	MELODY 1 ~ 5		No Data		
	CONDUCTOR		No Data		
MIDI	RECEIVE CH 1 ~ 16		All Enable		
	CLOCK		Disable		
MULTI PAD	1		4 banks x 4 pages = 16 patterns		
	2				
	3				
	4				

Page Memory MIDI Bulk Dump

The contents of each PAGE MEMORY can be bulk dumped via the MIDI OUT connector as a system exclusive message and received by a second PSR-500M or a MIDI data recorder.

1. Press the [MIDI BULK DUMP] button. All PAGE MEMORY indicators will flash and "bdp" will flash on the MULTI DISPLAY.

MIDI BULK DUMP



2. Press the button of the PAGE MEMORY you want to transmit. The corresponding indicator will flash while the data is being transmitted. The bulk dump can be aborted at any time by pressing the [MIDI BULK DUMP] button a second time. No other operations can be performed during a bulk transmission.
3. When the transmission has finished the PAGE MEMORY indicators and MULTI DISPLAY will return to their previous states.

AUTO ACCOMPANIMENT

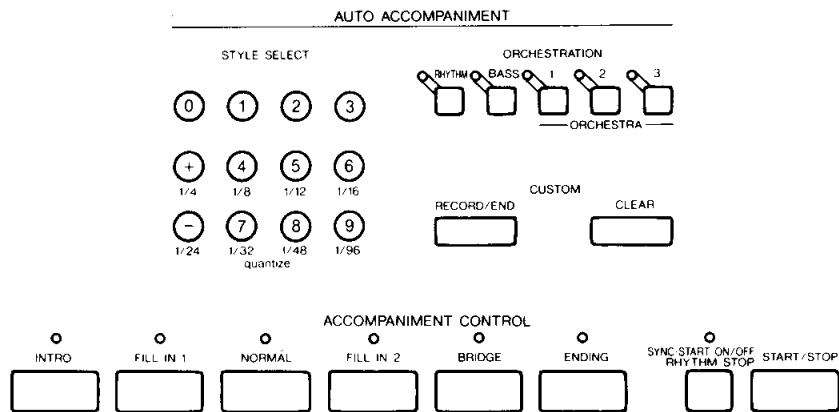

● STYLE SELECT

Select any of the PSR-500M's 100 accompaniment styles by using one of the two following methods:

1: Choose one of the 100 accompaniment styles — numbered "00" through "99" — shown on the STYLE LIST then enter its number using the numeric STYLE SELECT buttons. To select BAROQUE (number 27), for example, first press "2" and then "7." The number "27" should then be displayed on the left two digits of the MULTI DISPLAY.

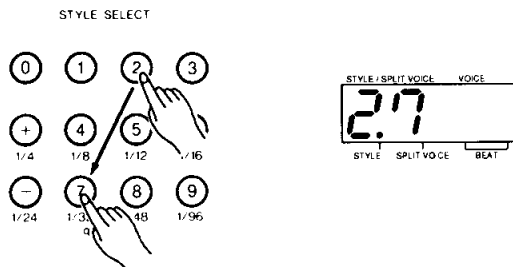

2: The [+] and [-] buttons in the STYLE SELECT group can be used to increment (increase by one) or decrement (decrease by one) the current accompaniment style number. Press the [+] button briefly to select the accompaniment style one number higher than the current accompaniment style, or the [-] button to select the accompaniment style one number lower than the current accompaniment style. If you hold the [+] or [-] button down, the accompaniment style number will increment or decrement continuously — simply release the button when the desired accompaniment style number has been reached.

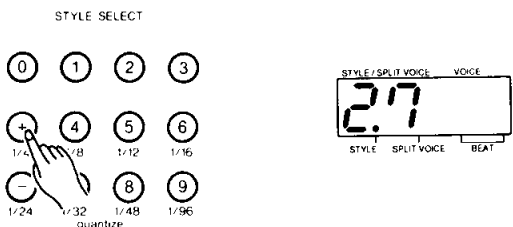

● ACCOMPANIMENT CONTROL

Starting the Accompaniment

Press the [START/STOP] button to start the selected accompaniment immediately. The rhythm sound will begin playing and, if the FINGERED or SINGLE FINGER mode is selected via the OVERALL CONTROL section MODE button, the bass and chord parts will also begin playing as soon as the first note or chord is played on the keyboard.

Press the [SYNC-START ON/OFF] button if you want the accompaniment to start when you play the first note on the keyboard. In this case the accompaniment is started by playing in the left-hand section of the keyboard if the FINGERED, SINGLE FINGER or SPLIT mode is selected, or by playing anywhere on the keyboard if the NORMAL mode is selected. If you press the [SYNC-START ON/OFF — RHYTHM STOP] button, the r. two dots in the MULTI DISPLAY and the [SYNC-START ON/OFF — RHYTHM STOP] button indicator will flash at the current tempo. The synchro start mode can be re-engaged by pressing the [SYNC-START ON/OFF — RHYTHM STOP] button again so that its indicator goes out.

● The right two dots in the MULTI DISPLAY will continue to flash while the rhythm plays to provide a visual indication of the current tempo.

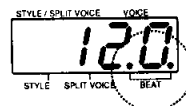

- A different accompaniment style can be selected at any time while the accompaniment is playing. The style number display will change as soon as the selection is made, but the new style will begin playback from the top of the next measure. The tempo will not change when the new style begins playing.

The NORMAL and BRIDGE Variations

Each style has two main variations — NORMAL and BRIDGE. If the [NORMAL] or [BRIDGE] button is pressed while the rhythm is playing, the corresponding variation will begin from the top of the next measure. You can also select [NORMAL] or [BRIDGE] before starting the accompaniment.



Starting the Accompaniment with an Introduction

Any of the PSR-500M accompaniment patterns can be started with an appropriate introduction by pressing the [INTRO] button and then the [START/STOP] button.

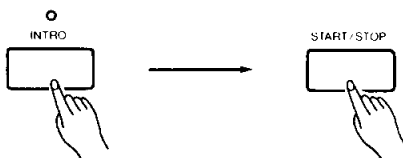

Once the [INTRO] button is pressed, the [INTRO] indicator will be lit continuously and the [NORMAL] or [BRIDGE] indicator will flash to indicate which variation will play when the introduction has finished. You can change the “destination” variation by pressing the [NORMAL] or [BRIDGE] button while its indicator is flashing. When the introduction ends, the [INTRO] indicator will go out and the [NORMAL] or [BRIDGE] indicator will light continuously.

- It is possible to start the accompaniment from any variation — even the ending — by pressing the corresponding button prior to pressing the [START/STOP] button. The destination [NORMAL] or [BRIDGE] variation can be selected in the normal way.
- If the [INTRO], [FILL IN 1], [FILL IN 2], or [ENDING] pattern is selected prior to pressing the [START/STOP] button and then the same button is pressed again or the currently flashing [NORMAL] or [BRIDGE] button is pressed, its indicator will go out and the destination [NORMAL] or [BRIDGE] pattern indicator will light continuously. Once started the accompaniment will then begin directly from the NORMAL or BRIDGE pattern.
- The [INTRO] button can be used to select the introduction pattern even while the accompaniment is playing.

Adding Fill-ins

The PSR-500M provides two types of fill-ins (rhythmic variations) — one which leads to the NORMAL variation and one which leads to the BRIDGE variation. Press the [FILL IN 1] button at any time while the accompaniment is playing to add a short fill-in and go to (or return to) the NORMAL variation, or press the [FILL IN 2] button to add a short fill-in and go to (or return to) the BRIDGE variation.

The [NORMAL] indicator will flash while FILL IN 1 plays, and the [BRIDGE] indicator will flash while FILL IN 2 plays. You can change the variation that will begin playing after the fill-in by pressing the desired variation button while the indicator is still flashing.

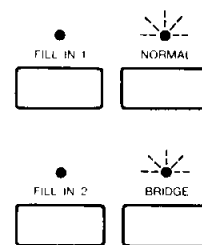

If you hold the [FILL IN 1] or [FILL IN 2] button, the fill-in pattern will repeat until the button is released, then the NORMAL or BRIDGE variation will begin from the beginning of the next measure.

- If the [FILL IN 1] or [FILL IN 2] button is pressed during the last 1/4-note of a measure, the fill in will begin from the first beat of the next measure. If pressed at any other time the fill-in will begin immediately.
- It is also possible to start the accompaniment with a fill-in by pressing the desired FILL IN button prior to pressing the [START/STOP] button. The destination [NORMAL] or [BRIDGE] variation can be selected in the normal way.

Stopping the Accompaniment

An accompaniment in progress can be stopped immediately by pressing the [START/STOP] button or the [SYNC-START ON/OFF — RHYTHM STOP] button. In the latter case the synchro start mode will be engaged when the accompaniment stops. The accompaniment can also be stopped with an appropriate ending by pressing the [ENDING] button.



- The ending will begin from the first beat of the next measure.
- If the [FILL IN 1] or [FILL IN 2] button is pressed while the ending pattern is playing, a fill-in will be played, followed by a return to the normal or bridge pattern.

● THE SINGLE FINGER MODE

The SINGLE FINGER mode is selected via the [MODE] button in the OVERALL CONTROL section (see page 10).

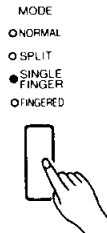

SINGLE FINGER accompaniment makes it simple to produce beautifully orchestrated accompaniment using major, seventh, minor and minor-seventh chords by pressing a minimum number of keys in the left-hand section of the keyboard. The accompaniment produced is perfectly matched to the currently selected accompaniment style.

If you press a "C" key in the left-hand section of the keyboard, for example, a C-major accompaniment will be played. Press another key in the left-hand section of the keyboard to select a new chord. The key you press will always determine the "root" of the chord played (i.e. "C" for a C chord).

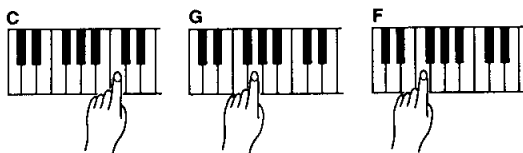

Playing Minor, Seventh, and Minor-seventh Chords in the Single-finger Mode



- For a minor chord, press the root key and a black key to its left.
 - For a seventh chord, press the root key and a white key to its left.
 - For a minor-seventh chord, press the root key and both a white and black key to its left.
- The automatic accompaniment will continue playing even if you lift your fingers from the Auto Accompaniment keys. You only need to press the Auto Accompaniment keys when changing chords.
 - If the SINGLE FINGER mode is used while the accompaniment is stopped, the appropriate bass and chord sound will be produced when any left-hand keys are pressed. The bass voice is the same as the accompaniment bass voice. The chord voice can be selected using the VOICE SELECT buttons after a key in the left-hand section of the keyboard has been pressed. REVERB DEPTH, VOLUME, OCTAVE, and PAN settings will affect the chord voice, but the DUAL VOICE mode cannot be used.

● THE FINGERED MODE

The FINGERED mode is ideal if you already know how to play chords on a keyboard, since it allows you to supply your own chords for the Auto Accompaniment feature.

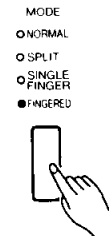

The PSR-500M will accept the following chord types:

Chord	Abbreviation	Normal Voicing
Major	M	1-3-5
Minor	m	1-b3-5
Major seventh	M7	1-3-(5)-7
Suspended fourth	sus4	1-4-5
Minor sixth	m6	1-b3-5-6
Minor seventh	m7	1-b3-(5)-b7
Minor seventh flatted fifth	m7-5	1-b3-b5-b7
Minor major seventh	mM7	1-b3-(5)-7
Seventh	7	1-3-(5)-b7
Seventh flatted fifth	7-5	1-3-b5-b7
Seventh suspended fourth	7sus4	1-4-5-b7
Augmented (seventh)	aug	1-3-#5-(b7)
Diminished (seventh)	dim	1-b3-b5-(b6)

* Notes in parentheses may be omitted.

Minor sixth chords will only be properly detected if they are played in "root position." Seventh flatted fifth chords will be recognized as long as either the root or flatted seventh is the lowest note. For diminished and augmented chords, the lowest key pressed is assumed to be the root.

- If you play two notes one octave apart on the left-hand section of the keyboard, that note will be taken as the root and the accompaniment will use only that note. If you play the root and fifth the accompaniment will use only the root and fifth.
- If you play three adjacent keys at once (semitone intervals), All accompaniment parts except for rhythm will be muted.
- If the FINGERED mode is used while the accompaniment is stopped, the appropriate bass note will be produced when a left-hand chord is detected, and the chord will sound as played. The chord voice can be selected using the VOICE SELECT buttons after a key in the left-hand section of the keyboard has been pressed. REVERB DEPTH, VOLUME, OCTAVE, and PAN settings will affect the chord voice, but the DUAL VOICE mode cannot be used.

● ORCHESTRATION

Accompaniment parts can be turned on or off by pressing the corresponding ORCHESTRA button. When a part is turned off the corresponding indicator will go out. To silence the bass part, for example, press the ORCHESTRATION [BASS] button so that its indicator goes out. Press the button again to turn that part back on.

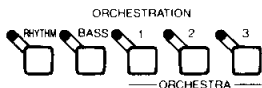

- Depending on the selected style, all ORCHESTRATION buttons may not always contain data (the indicators will light even if the corresponding ORCHESTRATION button does not contain data).

● CUSTOM STYLE

The PSR-500M CUSTOM STYLE feature lets you create original accompaniment styles — one for each PAGE MEMORY — which are stored as style number 99 (PROGRAMMABLE). You can program separate patterns for the INTRO, NORMAL, BRIDGE, FILL IN 1, FILL IN 2, and ENDING variations.

1. Select one of the preset or custom styles on which you want to base your new custom style prior to activating the CUSTOM STYLE feature.
2. Press the CUSTOM [RECORD/END] button. Style number 99 will automatically be selected and the ACCOMPANIMENT CONTROL variation LEDs will flash in sequence. If you press the [RECORD/END] button again at this point recording will be cancelled and the previous style will be re-selected.

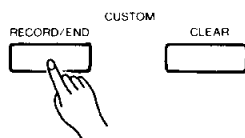

3. Select the variation you want to program by pressing the corresponding ACCOMPANIMENT CONTROL button.

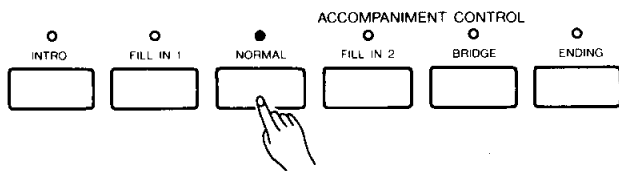

As soon as an ACCOMPANIMENT CONTROL variation button is pressed, the selected pattern will begin playing repeatedly (along with a metronome “click” sound which will not be recorded), based on a C chord.

- If you cancel recording at this point by pressing the [RECORD/END] button, any previously recorded CUSTOM STYLE data will be erased and the current style will be recorded in the CUSTOM STYLE memory.
4. The ORCHESTRATION buttons will be flashing in sequence. Select the part you want to program by pressing the corresponding ORCHESTRATION button. When an ORCHESTRATION button is pressed its indicator will light and the sound of that track will be emphasized. At this point you can press any other ORCHESTRATION button to select a different record track, as required. Further, by turning the selected track off, the ORCHESTRATION indicators will resume flashing in sequence and you can hear the overall volume balance of the accompaniment.

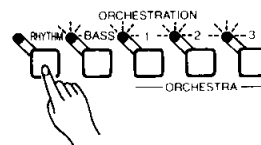

- The ORCHESTRATION [2] and [3] buttons each contain 2 tracks of data. Press either of these buttons once to select track A, and a second time to select track B. When the button is pressed a third time the part is turned off.

5. You can now add new material to the selected part by playing on the keyboard. You can completely clear a part if you want to record new material from scratch: press the ORCHESTRATION button corresponding to the part you want to clear while holding the [CLEAR] button. Individual notes can be cleared by pressing the appropriate key while holding the [CLEAR] button. This technique is particularly useful when recording drum parts.

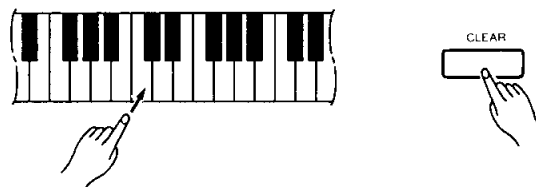
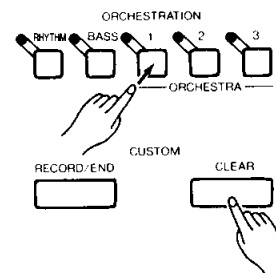

FEATURE REFERENCE (AUTO ACCOMPANIMENT)

When recording the RHYTHM track only a percussion voice (numbers 94 through 99) can be selected. Any voice can be selected when recording any of the other tracks. Note, however, that a special transpose function is applied to the BASS track, so we recommend that you record a bass voice on the BASS track.

- Be sure to record your CUSTOM ACCOMPANIMENT based on a C chord. The parts will be automatically transposed to match the chord played when the CUSTOM ACCOMPANIMENT is played back.

The percussion voices (numbers 94 through 99) and the SYNTH TOM voice (number 76) differ in operation from the other voices in the following ways:

1. During automatic playback they are not transposed to match the current chord.
 2. They can be played during rhythm-only auto accompaniment playback in the NORMAL mode.
- * If the DUAL function is engaged the above only apply if the percussion or SYNTH TOM voice is the main voice.

- The voice(s) assigned to the selected part can be changed by using the VOICE select keys in the normal way.
- The length of NORMAL, BRIDGE, INTRO, FILL, and ENDING variations is determined by the selected style.

6. Continue selecting and recording parts until the currently selected variation of your custom style is complete.

7. Press the CUSTOM [RECORD/END] button to stop recording. Your custom style will be automatically stored as style number 99, and can be selected and used in the same way as the preset styles.



- To record a different variation of the CUSTOM STYLE, repeat steps 2 through 7, above.

- The following data can be changed during CUSTOM STYLE recording:

- NOTE ON/OFF including velocity.
- TEMPO (the tempo setting that is active when recording is stopped is used).
- All VOICE section parameters except MIDI Channel (Auto Harmony, Reverb Depth, Volume, Octave, Pan, Dual Voice) can be set independently for each track.
- VOICE (including VOICE MEMORY) can be set independently for each track.
- One set of voice parameters, including the voice number, are memorized at the beginning of each track. This means that 7 sets of voice parameters are memorized for each custom style variation — RHYTHM, BASS, ORCHESTRA 1, 2A, 2B, 3A, and 3B.
- PITCH BEND (changes memorized in real time).
- SUSTAIN (changes memorized in real time).

- Custom styles have a somewhat simpler format than the preset styles, so some of the preset style data is changed when used in a custom style. In other words, the preset style may not sound exactly the same when used in a custom style.

Quantization

It is possible to set a quantize value before recording a part by pressing the appropriate STYLE SELECT key. The available quantize values are: 1/4, 1/6, 1/8, 1/12, 1/16, 1/24, 1/32, 1/48, 1/96. The selected quantize value forces all notes you play to fall on the nearest specified beat. If you select 1/8, for example, all notes you play will be aligned to the nearest eighth note. The selected quantize value will be shown on the display for approximately 2 seconds after the button is released.

One measure of 8th notes before quantization



After quantization



- The default quantize value is 1/96. This value is automatically selected whenever the CUSTOM STYLE record mode is engaged.

- Material that has already been recorded on a track will not be quantized. Only notes played after the quantization value has been changed will be quantized to that value.

- Quantization is applied to both note-on and note-off timing. In some cases the length of a quantized note may be reduced to an extremely short value of both the note-on and note-off timing of the same note are quantized to the same beat.

Before quantize

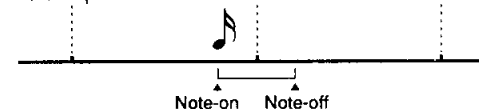

After quantize



- When a CUSTOM STYLE has been recorded, be sure to store the new data to a PAGE MEMORY (see page 13). If this is not done the newly recorded CUSTOM STYLE data will be lost when a different PAGE MEMORY is selected.

- If the CUSTOM STYLE memory becomes full during recording, "End" will appear on the MULTI DISPLAY and recording will end. Up to approximately 1,600 notes (including INTRO, FILL and other variations) can be recorded in each CUSTOM STYLE.

VOICE

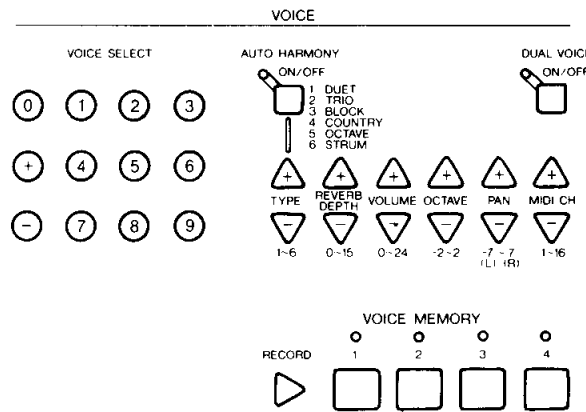

● VOICE SELECT

Select any of the PSR-500M's 100 voices by using one of the following methods:

Voice Selection Method 1:

Choose one of the 100 voices — numbered "00" through "99" — shown on the panel VOICE LIST then enter its number using the numeric VOICE SELECT buttons. To select "ELECTRONIC ORGAN 1" (number 12), for example, first press "1" and then "2." The number "12" should then appear on the right two digits of the MULTI DISPLAY.

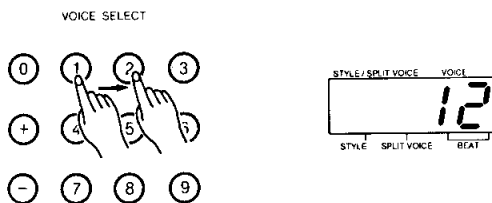

Voice Selection Method 2:

The [+] and [-] buttons in the numeric VOICE SELECT button group can be used to increment (increase by one) or decrement (decrease by one) the current voice number. Press the [+] button briefly to select the voice one number higher than the current voice, or the [-] button to select the voice one number lower than the current voice. If you hold the [+] or [-] button down, the voice number will increment or decrement continuously — simply release the button when the desired voice number has been reached.

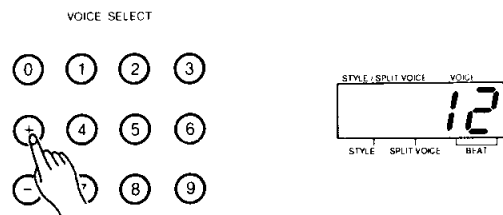

- Note that the PSR-500M keyboard has "touch response" — that is, you can control the loudness of the sound to a certain degree according to how hard you play the keys. The degree of touch sensitivity is different for each voice. For example, the piano and percussion voices are very responsive to keyboard touch, while the organ voices have no touch response at all.

Keyboard Percussion

When any of the percussion voices is selected (voice numbers 94 through 99), you can play a range of drum and percussion instruments on the keyboard.

The percussion instruments played by the various keys when voice 98 PERCUSSIONS W/GATE or 99 PERCUSSIONS are selected are marked by symbols above the keys.

- The TRANSPOSE, TUNING, and OCTAVE functions described on pages 12 and 24 do not affect the percussion sounds. The percussion sounds are affected, however, by the PITCH BEND, PAN, and VOICE section VOLUME, REVERB DEPTH, MIDI CHANNEL, and HARMONY controls.

FEATURE REFERENCE (VOICE)

DRUM & PERCUSSION INSTRUMENT KEY ASSIGNMENTS

94 SCRATCH W/PITCH

Key	Instrument
C1~C6	Scratch

95 KICK & SNARE W/PITCH

Key	Instrument
C1~B1	Bass Drum Heavy
C2~B2	Bass Drum Light
C3~B3	Snare Low
C4~B4	Snare High
C5~C6	Synth Snare

96 TOM W/PITCH

Key	Instrument
C1~B2	Acoustic Tom
C3~C6	Synth Tom

97 LATIN PERCS W/PITCH

Key	Instrument
C1~B1	Conga
C2~B2	Bongo
C3~B3	Timbale
C4~B4	Agogo
C5~C6	Cuica

98 PERCUSSIONS W/GATE

99 PERCUSSIONS

Key	Instrument	Key	Instrument
C1	Bass Drum Low	G3	Bongo Low
C#1	Triangle Mute	G#3	Bongo High
D1	Synth Snare	A3	Timbale Low
D#1	Triangle Open	A#3	Timbale High
E1	Synth Tom Bass	B3	Tambourine
F1	Synth Tom Low	C4	Claves Low
F#1	Synth Tom Middle	C#4	Claves High
G1	Synth Tom High	D4	Agogo Low
G#1	Bass Drum High	D#4	Agogo High
A1	Bass Drum Middle	E4	Cuica Low
A#1	Closed Rim Shot	F4	Cuica High
B1	Tom Bass	F#4	Whistle
C2	Tom Low	G4	Brush Squeeze
C#2	Snare High	G#4	Hi-Hat Foot
D2	Tom Middle	A4	Snare Low with Gate Reverb
D#2	Open Rim Shot	A#4	Voice 'One'
E2	Snare Low	B4	Voice 'Two'
F2	Tom High	C5	Voice 'Three'
F#2	Handclaps	C#5	Voice 'Four'
G2	Cowbell	D5	Scratch Low
G#2	Cabasa	D#5	Scratch High
A2	Hi-Hat Closed	E5	Bongo Mute
A#2	Brush Hit	F5	Maracas
B2	Hi-Hat Open	F#5	House Bass Drum
C3	Crash Cymbal	G5	House Snare Drum
C#3	Splash Cymbal	G#5	House Tom Bass
D3	Ride Cymbal 1	A5	House Tom Low
D#3	Ride Cymbal 2	A#5	House Tom Middle
E3	Conga Low	B5	House Tom High
F3	Conga High	C6	House Hi-Hat
F#3	Conga Mute	—	—

● THE SPLIT MODE

The PSR-500M SPLIT mode — selected via the [MODE] button — allows you to play two voices at once: one with the left hand and one with the right. The left-hand voice can be played to the left of the “split point,” set as described in “SPLIT POINT CHANGE” on page 13, and the right-hand voice can be played to the right of the split point.

When the SPLIT mode is first selected the current voice is assigned to the right-hand keys. The right-hand voice number will be shown on the right two digits of the MULTI DISPLAY, and the left-hand voice number will appear on the left two digits of the MULTI DISPLAY when a key to the left of the split point is pressed for about 2 seconds (the “SPLIT VOICE” dot in the display also will light).

- MODE
- NORMAL
- SPLIT
- SINGLE
- FINGERED
- FINGERED

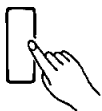

Changing the Right and Left-hand Voices

To change the right-hand voice press a key to the right of the split point, then select the new right-hand voice in the normal way.

To change the left-hand voice press a key to the left of the split point, then select the new left-hand voice in the normal way.

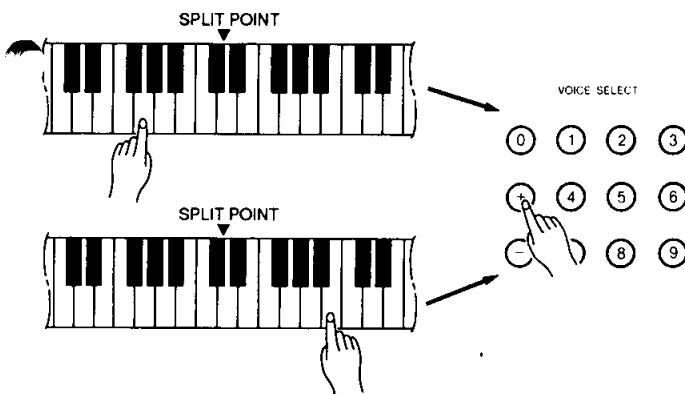

- When the SPLIT MODE is used with the DUAL VOICE function (see page 23) different dual voices can be assigned to the left- and right-hand sections of the keyboard. Press a key to the right of the split point to select the right-hand voice, then turn DUAL VOICE on and select the right-hand dual voice. Press a key to the left of the split point to select the left-hand voice, then turn DUAL VOICE on and select the left-hand dual voice.

● REVERB DEPTH

The depth of the selected DSP effect can be increased or decreased for the selected voice by using the REVERB DEPTH [▲] or [▼] button. The reverb depth range is from 0 (no effect) to 15 (maximum reverb depth). The reverb depth is shown on the MULTI DISPLAY while the REVERB DEPTH [▲] or [▼] button is held, and for approximately 2 seconds after either REVERB DEPTH [▲] and [▼] buttons simultaneously immediately selects reverb depth value 6.

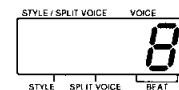

- No effect is produced when the reverb depth is set to 0. From settings 1 to 8 the original sound is maintained at the same level while the level of the effect sound is increased. From settings 9 to 15 the effect level is maintained while the level of the original sound is reduced.
- In the SPLIT mode the left-hand voice reverb depth can be adjusted after playing a left-hand key and the right-hand voice reverb depth can be adjusted after playing a right-hand key.

● VOLUME

Although the MASTER VOLUME control can be used to set the overall volume level, the VOLUME [▲] and [▼] buttons can be used to adjust the volume of the selected voice in relation to all other sound produced by the PSR-500M — i.e. accompaniment, song memory, etc. Press the [▲] button to increase the volume, or the [▼] button to decrease the volume. The selected volume level will be displayed on the MULTI DISPLAY while the volume is being adjusted, and for approximately 2 seconds after either VOLUME button is released.

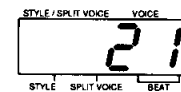

The volume range is from 0 to 24, with 0 producing no sound while 24 is the highest volume. The default volume value (21) can be recalled at any time by pressing both the VOLUME [▲] and [▼] buttons at the same time.

- In the SPLIT mode the left-hand voice volume can be adjusted after playing a left-hand key and the right-hand voice volume can be adjusted after playing a right-hand key.

● OCTAVE

The OCTAVE [▲] and [▼] buttons can be used to shift the pitch of the selected voice up or down by one or two octaves. Press the [▲] button to shift the pitch up, or the [▼] button to shift the pitch down. The selected octave (-2, -1, 0, 1, or 2) will be displayed on the MULTI DISPLAY while the octave value is being adjusted, and for approximately 2 seconds after either OCTAVE button is released. A setting of 0 produces the normal pitch for the voice. The normal octave (0) can be recalled at any time by pressing both the OCTAVE [▲] and [▼] buttons at the same time.

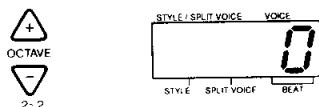

- In the SPLIT mode the left-hand voice octave can be shifted after playing a left-hand key and the right-hand voice octave can be shifted after playing a right-hand key.
- The OCTAVE cannot be changed while the keyboard is being played.

● PAN

The PAN [▲] and [▼] buttons can be used to pan the sound of the selected voice to any of 15 positions between full left and right in the stereo sound field. Press the [▲] button to pan the voice to the right, or the [▼] button to pan the voice to the left. The selected pan position will be displayed on the MULTI DISPLAY while the pan value is being adjusted, and for approximately 2 seconds after either PAN button is released.

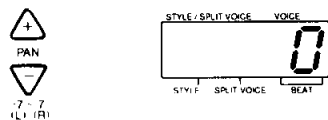

The PAN range is from -7 (full left) through 0 (center) to 7 (full right). The center position (0) can be recalled at any time by pressing both the PAN [▲] and [▼] buttons at the same time. The new PAN value will take effect as soon as the next key is played.

- In the SPLIT mode the left-hand voice can be panned after playing a left-hand key and the right-hand voice can be panned after playing a right-hand key.

● MIDI CHANNEL

The MIDI transmit channel for the selected voice is set via the MIDI CH. [▲] and [▼] buttons in the VOICE section. The [▲] button increments the transmit channel number and the [▼] button decrements the channel number. The current channel number is shown on the MULTI DISPLAY while selection is in progress and for approximately 2 seconds after both MIDI CH. buttons are released. The MIDI transmit channel range is from 1 to 16.

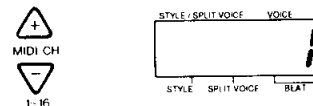

- Different transmit channels can be set for the left- and right-hand voices in the split mode — press a left-hand key prior to setting the left-hand transmit channel, and a right-hand key prior to setting the right-hand transmit channel.
- The MIDI CHANNEL cannot be changed while the keyboard is being played.

● DUAL VOICE

The DUAL VOICE feature makes it possible to select and play two different voices simultaneously.

To activate the DUAL VOICE feature press the [DUAL VOICE ON/OFF] button (the indicator will light). When ON, the voice selected prior to turning the DUAL VOICE feature ON will sound simultaneously with a second “dual” voice. Any voice can be selected as the dual voice while the DUAL feature is ON, and its number will be shown on the right two digits of the MULTI DISPLAY.

The DUAL VOICE feature can be turned OFF by pressing the [DUAL VOICE ON/OFF] button a second time.

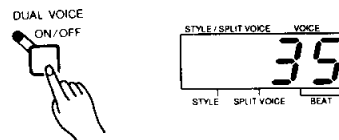

- The AUTO HARMONY function (see page 25) applies only to the main voice in the DUAL VOICE mode.
- Only main voice data is transmitted via the MIDI OUT connector on the specified MIDI channel for that voice (see above) in the DUAL VOICE mode.
- REVERB DEPTH, VOLUME, OCTAVE, and PAN can be set independently for the main and sub voices in the DUAL VOICE mode.
- In the SPLIT mode the left-hand dual voice can be selected after playing a left-hand key and the right-hand dual voice can be selected after playing a right-hand key.

● AUTO HARMONY

Auto Harmony can be used in the SPLIT, SINGLE FINGER, and FINGERED modes. It automatically adds appropriate harmony notes to a melody you play on the keyboard. You can choose from 6 different types of harmony.

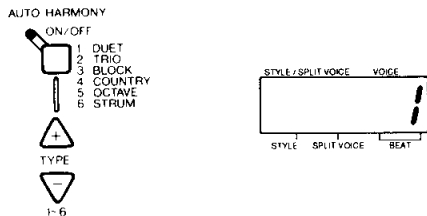

Use the AUTO HARMONY TYPE [▲] and [▼] buttons to select a harmony type between "1" and "6."

The selected harmony type number will be shown on the rightmost digit of the MULTI DISPLAY while the AUTO HARMONY TYPE [▲] or [▼] button is pressed.

Once the desired harmony type has been selected, press the [AUTO HARMONY ON/OFF] button so that its indicator lights to engage the AUTO HARMONY feature.

PSR-500M Harmony Types

- 1 DUET
- 2 TRIO
- 3 BLOCK
- 4 COUNTRY
- 5 OCTAVE
- 6 STRUM

- The harmony produced is based on the chord played on the left-hand section of the keyboard in the FINGERED, SINGLE FINGER, or SPLIT modes. If no chord is detected, no harmony is produced.

Only a single note can be played at a time on the keyboard (or the right-hand section of the keyboard) when the AUTO HARMONY feature is used.

- The harmony can be muted by playing any three consecutive notes on the left-hand section of the keyboard.
- Although a single note or an interval of a fifth can be used to produce FINGERED mode auto accompaniment, these are not recognized in the SPLIT mode.
- If AUTO HARMONY is used at the same time as the DUAL feature (see page 24), harmony will not be applied to the second "dual" voice.
- If AUTO HARMONY is used at the same time as the SPLIT feature (see page 23), harmony will be not be applied to the left-hand voice.

● VOICE MEMORY

The PSR-500M VOICE MEMORY can be used to store 4 different sets of voice combinations — i.e. main, dual, and split voices — that can then be recalled simply by pressing a single button.

Recording

Make the desired voice settings in the normal, dual, and split modes, then press one of the VOICE MEMORY buttons — [1] through [4] — while holding the [RECORD] button. The corresponding indicator will light indicating that the data has been memorized.

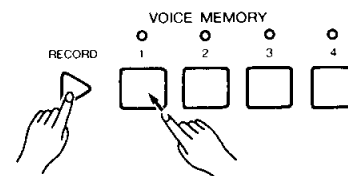

Recall

To recall a VOICE MEMORY setting simply press the appropriate VOICE MEMORY button. The corresponding indicator will light and the required voice settings will be recalled. If you press the same VOICE MEMORY button a second time, its indicator will go out and the previous voice settings will be recalled.

- VOICE MEMORY recall operations can be recorded using the Custom Accompaniment, Song Memory (Melody), and Multi Pad features. If the contents of the voice memory are changed while any of these are being played back, the new voices will take effect from the next time playback is started.

- VOICE MEMORY data will be retained in memory even when the PSR-500M power is turned off as long as a full set of good batteries is present or an AC power adaptor remains connected (see "PAGE MEMORY" on page 13 for more details).
- When a VOICE MEMORY has been recorded, be sure to store the new data to a PAGE MEMORY (see page 13). If this is not done the newly recorded VOICE MEMORY data will be lost when a different PAGE MEMORY is selected.

SONG MEMORY

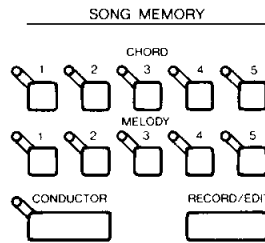

SONG MEMORY

PLAY/STOP



The PSR-500M SONG MEMORY allows you to “record” and play back chord sequences created using the Auto Accompaniment feature and melody lines you play on the keyboard.

The SONG MEMORY also has five separate CHORD “banks” that can be used to record different accompaniments, and five MELODY banks that can be used to record different melodies or parts of a song. A “CONDUCTOR” function is also provided which allows the various banks can be “chained” — i.e. they will play back in any specified order. This allows you to record verses and choruses in different banks, for example, then “chain” them in the desired order for playback.

- Material recorded using the SONG MEMORY is retained in memory even when the POWER switch is turned OFF if batteries are present or an AC adaptor is connected (see “PAGE MEMORY” on page 13 for more details).
- Chord or melody parts recorded in the SONG MEMORY can be selected and played at any time while auto accompaniment is playing. Simply press a chord or melody memory button to play the corresponding part, then press the same button again to exit.
- When a SONG MEMORY recording has been finished, be sure to store the new data to a PAGE MEMORY (see page 13). If this is not done the newly recorded SONG MEMORY data will be lost when a different PAGE MEMORY is selected.

● RECORDING A MELODY

1. Press one of the MELODY buttons — [1] through [5] — while holding the [RECORD] button. The corresponding MELODY indicator will flash, indicating that the SONG MEMORY is now in the record ready mode. The metronome will also begin to sound at the currently selected tempo, while the [SYNC-START ON/OFF] button indicator and the right two dots in the MULTI DISPLAY flash at the current tempo.

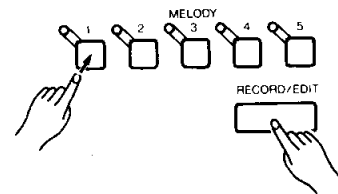

- If you have already recorded other MELODY or CHORD banks that you want to hear while recording the new melody bank, press the corresponding MELODY or CHORD buttons. The indicators of banks selected for playback will flash slowly.

2. Recording will begin as soon as you play a note on the keyboard or press the SONG MEMORY [PLAY/STOP] button or the ACCOMPANIMENT CONTROL [START/STOP] button.
3. Play the melody using the entire keyboard if the NORMAL mode is selected, or the keys to the right of the split point if the SPLIT, FINGERED, or SINGLE FINGER mode is selected.
 - The rhythm part of the currently selected style will play automatically during recording. If you want to turn it off, press the ORCHESTRATION RHYTHM button.
 - Some of the preset styles (and custom styles based on those presets) use percussion voices in parts other than the rhythm part. Use the corresponding ORCHESTRATION button if you want to turn the percussion voices off.
4. Stop recording by pressing the ACCOMPANIMENT CONTROL [START/STOP] or [ENDING] button, or the SONG MEMORY [PLAY/STOP] button.



- In addition to notes played on the keyboard, changes in the following data can be recorded by the SONG MEMORY MELODY banks:
 - Pitch Bend
 - Sustain on/off
 - Voice Number (including VOICE MEMORY bank number)
 - Auto Harmony (TYPE, ON/OFF)
 - Octave
 - Voice Volume
 - Reverb Depth
 - Pan
 - Multi Pad Play/Terminate
 - Dual Voice (Voice number, ON/OFF)

Data Edit Mode

It is possible to change any of the above parameters for a specific track by pressing the appropriate MELODY track button twice while holding the [RECORD] button. The indicator of the selected track will flash slowly indicating that the track is in the edit ready mode. Press a key or the [PLAY/STOP] button and the track will play. You can now change the parameters while listening to the result. Changes affect that last occurrence of the corresponding parameter in the track, as shown in the examples below. The last parameter change takes priority. Press the [PLAY/STOP] button to exit when you're finished editing.

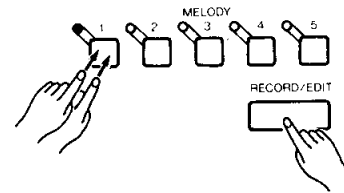

- It is also possible to listen to other recorded tracks while editing the selected track.
- Voice memory ON/OFF events cannot be added or edited in the data edit mode.

Example 1

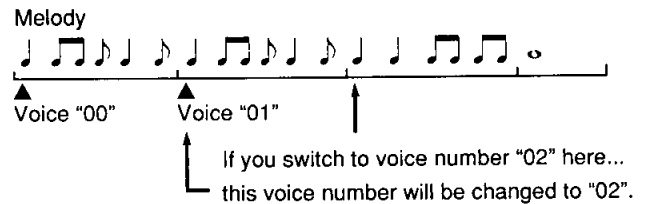

Example 2

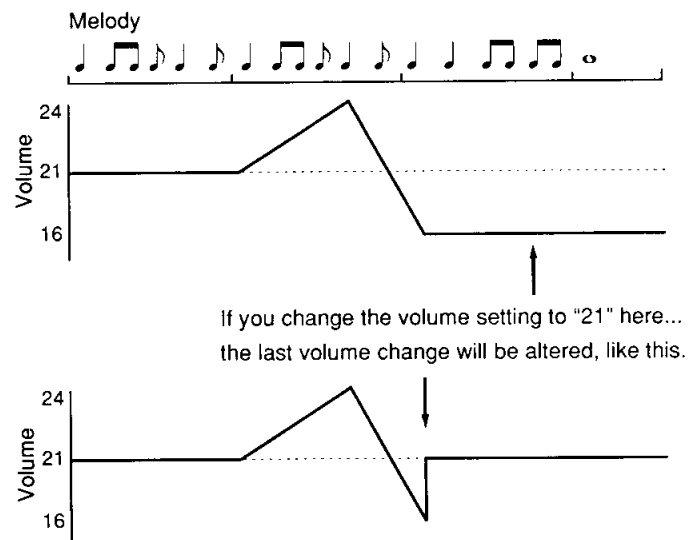

● RECORDING A CHORD SEQUENCE

1. Select an accompaniment style that is appropriate for the type of music you want to record.
2. Press one of the CHORD buttons — [1] through [5] — while holding the [RECORD] button. This engages the record ready mode for the selected bank. The selected CHORD bank indicator will flash, the metronome will sound, and the [SYNC-START ON/OFF] indicator and right two dots in the MULTI DISPLAY will flash at the currently selected tempo.

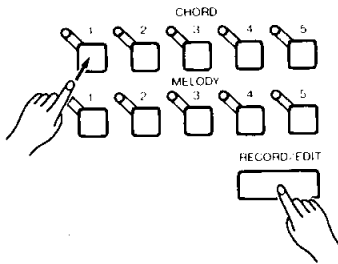

- If the NORMAL or SPLIT mode is selected, the FINGERED mode is automatically selected when the record ready mode is engaged. If the FINGERED or SINGLE FINGER mode is selected, no change occurs.
- If you have already recorded one or more MELODY banks that you want to hear while recording the CHORD bank, press the corresponding MELODY buttons as well. The indicators of MELODY banks selected for playback will flash slowly. MELODY banks that were turned on during CHORD bank playback will also be played back.
- It is also possible to record a MELODY bank at the same time as you record a CHORD bank — press the MELODY bank button to be recorded while holding the [RECORD] button before beginning recording of the CHORD bank.

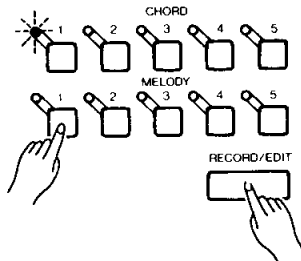

3. Recording will begin as soon as you play a chord or note on the left-hand section of the keyboard. If you've selected a MELODY bank to record with the CHORD bank, a right-hand note will also start the recording process.

Recording can also be started by pressing the ACCOMPANIMENT CONTROL [START/STOP] button or the SONG MEMORY [PLAY/STOP] button. In this case only the rhythm will begin without bass and chord accompaniment until you play the first chord or note on the left-hand section of the keyboard.

4. Play the required chords (FINGERED or SINGLE FINGER) in the left-hand section of the keyboard. If you've also selected a MELODY bank to be recorded, play the melody on the right-hand section of the keyboard.

You can also turn previously-recorded MELODY banks on and off while recording the CHORD bank, and these changes will be recorded along with the chord data.

5. Stop recording by pressing the ACCOMPANIMENT CONTROL [START/STOP] or [ENDING] button, or the SONG MEMORY [PLAY/STOP] button.

• In addition to chord changes, changes in the following data can be recorded by the SONG MEMORY CHORD banks:

- Normal, Bridge, and Ending Variations
- Fill-Ins
- MELODY Bank Switching
- Orchestration
- Style Number
- Accompaniment Volume (one setting only at the beginning of each bank)
- Tempo (one setting only at the beginning of each bank)

• The following data can be changed by using the Data Edit Mode.

- Accompaniment Volume
- Tempo

Data Edit Mode

It is possible to change any of the above parameters for a specific track by pressing the appropriate CHORD track button twice while holding the [RECORD] button. The indicator of the selected track will flash slowly indicating that the track is in the edit ready mode. Press a key or the [PLAY/STOP] button and the track will play. You can now change the parameters as many times as required while listening to the result. The last parameter change takes priority. Press the [PLAY/STOP] button to exit when you're finished editing.

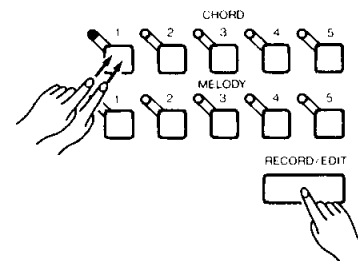

- It is also possible to listen to other recorded melody tracks while editing the selected track.

- Whenever you record using the SONG MEMORY, any previously recorded material in the same bank will be erased.
- If the power is turned off while recording, material recorded up to the point at which the power was disconnected will be retained in memory (the last event, however, may be lost). All data will be lost, however, if the power is not restored within approximately 10 minutes after disconnection if a good set of batteries is not installed (see "PAGE MEMORY" on page 14 for more details).
- If the SONG MEMORY becomes full while recording, "End" will appear on the MULTI DISPLAY and recording will stop. Up to approximately 700 notes can be recorded in each MELODY bank. Up to approximately 150 chords can be recorded in each CHORD bank.

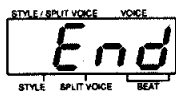

● MELODY AND CHORD PLAYBACK

1. Any number of MELODY banks and/or one CHORD bank can be played back at the same time. Press the buttons corresponding to the MELODY and/or CHORD banks you want to play back — the indicators of the selected banks will flash.

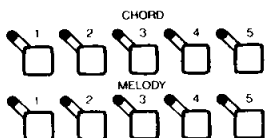

2. Playback will begin as soon as a key on the keyboard, the SONG MEMORY [PLAY/STOP] button, or the ACCOMPANIMENT CONTROL [START/STOP] button is pressed. If you press a different bank button during playback, playback of the newly selected bank will begin from the top of the next measure.



- If you press a MELODY or CHORD bank button while an accompaniment style is already playing, the selected melody or chord sequence will begin playing from the beginning of the next measure. You can return to the accompaniment by pressing the same CHORD bank button a second time. The accompaniment will resume playing from the beginning of the next measure. A melody that is playing can be stopped by pressing the same MELODY button a second time.
 - If you select a CHORD bank during auto accompaniment, the NORMAL mode will be automatically selected. The FINGERED or SINGLE FINGER mode will be automatically re-selected when you return to the auto accompaniment.
 - When a CHORD bank is selected during auto accompaniment, the style, tempo, accompaniment volume, orchestration, and accompaniment control settings recorded in the selected CHORD bank will be used even after you return to the auto accompaniment.
3. Play along on the keyboard if you like. You can also change the tempo during playback.
 4. Individual MELODY banks can be stopped during playback by pressing their buttons. If you press a CHORD bank button while it is playing, that bank will stop playing at the top of the next measure and auto accompaniment will begin (the last chord will remain active until a new chord is played). The mode that was engaged immediately prior to activating CHORD playback will be automatically recalled.
 5. MELODY playback will stop automatically when all recorded data has been played back. CHORD banks that were not recorded with a complete ending will repeat until stopped (if you pressed the [PLAY/STOP] button before the ending finished the bank will play repeatedly). You can also stop playback at any time by pressing the SONG MEMORY [PLAY/STOP] button or the ACCOMPANIMENT CONTROL [START/STOP] button.
- If memory playback is stopped by pressing a MELODY or CHORD button, that track will be turned off but the rhythm will not stop. Use the [PLAY/STOP] if you want to stop the rhythm at the same time.

● THE CONDUCTOR

The SONG MEMORY CONDUCTOR function allows CHORD and MEMORY banks to be “chained” and automatically played back in any order.

Recording

1. Press the [CONDUCTOR] button while holding the [RECORD] button to engage the CONDUCTOR record ready mode. The [CONDUCTOR] button indicator will flash. The indicators of all CHORD and MELODY banks that contain recorded data will also flash.

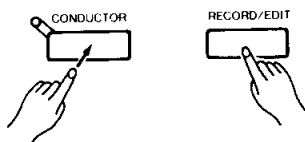

• The CONDUCTOR record ready mode can not be engaged if none of the CHORD and MELODY banks contain data.

2. Press the CHORD and/or MELODY bank buttons that you want to begin playback with — the selected bank indicators will light continuously.
3. Press the SONG MEMORY [PLAY/STOP] button to begin recording.

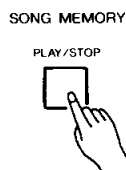

4. Press the CHORD and MELODY bank buttons at the appropriate times in the order that you want them to play (playback will actually begin from the beginning of the next measure). Any MELODY bank on/off events recorded in a chord bank remain active in a CONDUCTOR chain.
5. Recording will end when a complete ending in the data is encountered, or when the SONG MEMORY [PLAY/STOP] button is pressed.

• If the memory becomes full during CONDUCTOR recording, “End” will appear on the MULTI DISPLAY and recording will stop. The CONDUCTOR memory capacity is approximately 200 “events” — each button press (on or off) is an event.

Playback

1. To playback the CONDUCTOR sequence simply press the [CONDUCTOR] button so that its indicator flashes, and then press the SONG MEMORY [PLAY/STOP] button.

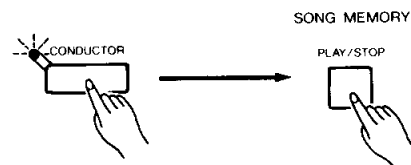

2. CONDUCTOR playback will stop automatically when the end of the sequence is reached. You can also stop playback at any time by pressing the SONG MEMORY [PLAY/STOP] button.

THE MULTI PADS

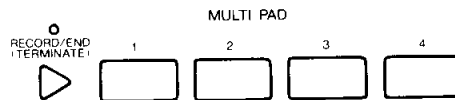

The PSR-500M MULTI PADS can be used to record short rhythmic or melodic sequences, percussion fill-ins, or single percussion sounds that can be played at any time simply by pressing the appropriate pad.

Recording

1. Select the voice you want to use, then press one of the MULTI PAD buttons — [1] through [4] — while holding the MULTI PAD [RECORD/END] button. The [RECORD/END] button indicator will flash to indicate that the record ready mode is engaged, and the metronome will begin to sound.

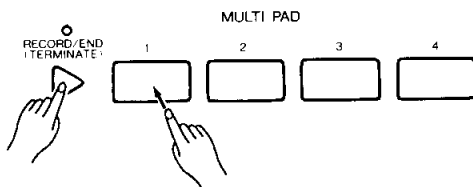

- The NORMAL mode is automatically selected when recording is started.

2. Play a short sequence.
3. Press the MULTI PAD [RECORD/END] button to stop recording. Recording will also stop automatically and “End” will appear on the MULTI DISPLAY when the pad memory becomes full.
 - Each MULTI PAD can record up to approximately 70 consecutive quarter notes. Pitch bend, program change, and other operations reduce the number of notes that can be recorded.

- The following data is recorded in the MULTI PAD memory:
 - Note on/off and velocity.
 - Auto Harmony on/off and type.
 - Reverb depth.
 - Volume.
 - Octave.
 - Pan.
 - Dual.
 - Voice Number (including VOICE MEMORY bank number).

Playback

Simply tap any of the MULTI PADS at any time to play back the data they contain. MULTI PAD playback begins as soon as the button is pressed.

MULTI PAD playback can be terminated by pressing the [RECORD/END (TERMINATE)] button.

- MULTI PAD playback speed is determined by the current TEMPO setting.
- The contents of the MULTI PAD memory are retained in memory even when the power is turned off (see “PAGE MEMORY” on page 13 for details).
- When a MULTI PAD has been recorded, be sure to store the new data to a PAGE MEMORY (see page 13). If this is not done the newly recorded MULTI PAD data will be lost when a different PAGE MEMORY is selected.

MIDI

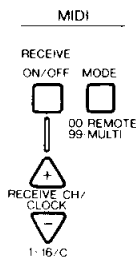

● RECEIVE CHANNEL/CLOCK

The enable/disable status of all MIDI receive channels is set via the MIDI section RECEIVE CH./CLOCK [▲] and [▼] buttons. The [▲] button increments the receive channel number shown on the display and the [▼] button decrements the receive channel number. The receive channel number is shown on the right two digits of the MULTI DISPLAY while the status — “E” for enabled or “d” for disabled — appears on the leftmost digit. The MIDI channel and status display appears while selection is in progress and for approximately 2 seconds after both MIDI CH. buttons are released. A “C” in place of the channel number (1 through 16) stands for “CLOCK,” and allows reception of the MIDI clock to be turned on or off. If the [RECEIVE ON/OFF] button is used while the MIDI receive channel or clock display is showing, the status of the channel or clock can be switched between “E” and “d.”

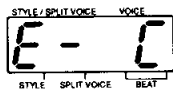
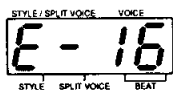
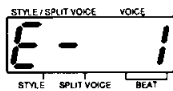

- Receive channel/clock settings apply to both the Remote Control and Multi Voice receive modes.
- Separate receive channel/clock settings are retained in each PAGE MEMORY even when the power is turned off (see “PAGE MEMORY” on page 14 for details).

● MODE

The [MODE] button is used to select the MIDI receive mode in which the PSR-500M is to operate — Remote Control or Multi Voice.

Press the [MODE] button to call the mode display, then use the same button to select “00” (Remote Control) or “99” (Multi Voice).



- The MIDI MODE is automatically reset to “00” whenever the power is turned on, when a different PAGE MEMORY is selected, or when the DEMO function is used.

■ The Remote Control Mode (Mode 00)

The Remote Control mode should be used when the PSR-500M is to be connected to a second keyboard by which it is to be controlled. In this mode playing the external keyboard has exactly the same effect as playing the PSR-500M’s own keyboard. Further the PSR-500M panel controls can be used as normal. This mode is automatically selected whenever the PSR-500M is turned on, when a different PAGE MEMORY is selected, or when the DEMO function is used.

Data Received In the Remote Control Mode

The PSR-500M receives and responds to the following data received via the MIDI IN connector when the Remote Control mode is selected:

- In addition to note and velocity data, the PSR-500M responds to program change, sustain ON/OFF, vibrato, volume, pan, reverb, start, stop, and MIDI clock messages.
- Program change messages 00 through 99 correspond to voices 00 through 99.
- See page 34 for details on control change messages.

- Program change and control change data only affects the main voice in the NORMAL mode (the right-hand voice when the SPLIT mode is selected) when the DUAL function is engaged.
- MIDI start messages control PSR-500M auto accompaniment, song memory play or record start, and conductor play or record start in the same way as the panel [START/STOP] button.
- MIDI stop messages have the same effect as pressing the panel [START/STOP] button when a function is running.
- When a single receive channel is selected, reception only occurs on the specified channel.
- Transpose settings affect received MIDI note numbers.
- Pitch bend data from 00H 00H to 7FH 7FH is received, with 00H 00H corresponding to minimum and 7FH 7FH to maximum pitch bend wheel position. The panel pitch bend range setting affects the received pitch bend data.
- External synchronization is automatically selected when MIDI clock is received if clock reception is turned on. If the external MIDI clock data is not received, internal clock operation is automatically resumed.
- If the TEMPO [▲] or [▼] button is pressed during external sync mode is engaged, "EC" (External Clock) will appear on the display. In this state the TEMPO value cannot be changed.

■ The Multi Voice Mode (Mode 99)

The Multi mode should be used when the PSR-500M is to be used as a multi-timbral tone generator, for example, receiving data from a second MIDI device (such as a sequencer). In this mode the PSR-500M can receive on multiple MIDI channels, each channel corresponding to a different voice. In this mode local keyboard performance and the VOICE section settings function normally regardless of received MIDI data. Since the PSR-500M employs the Yamaha Dynamic Voice Allocation system, it is not necessary to specify the number of notes that can be played via each channel.

- When the Multi Voice mode is selected, the following panel features can not be used:
 - SONG MEMORY
 - MULTI PAD
 - AUTO ACCOMPANIMENT & ACCOMPANIMENT CONTROL
 - CUSTOM ACCOMPANIMENT
 - TEMPO & ACCOMPANIMENT VOLUME

Data Received In the Multi Voice Mode

In the Multi mode the PSR-500M functions as a multi-timbre tone generator, allowing different voices to be played on all 16 MIDI channels.

- Program change messages 00 through 99 correspond to voices 00 through 99.

- MIDI note, velocity, and other channel messages received on a MIDI channel will affect only the voice selected for that channel.
- Velocity sensitivity for each voice is the same as when the voices are played via the PSR-500M keyboard.
- The panel TRANSPOSE setting does not affect the received MIDI data.
- The tuning and DSP settings affect the received note data.
- Pitch bend data is received independently for each channel. The panel PITCH BEND RANGE setting applies to all channels.
- Sustain on/off, reverb depth, volume, vibrato, and pan messages are accepted for each channel. See page 34 for details.
- MIDI start, stop, and clock data will be ignored.
- The program change, control change, and pitch bend status of each channel are reset whenever the power is turned on or the mode is switched from "00" to "99." The default program change value is "00" (PIANO), the default pitch bend value is "center." See page 34 for default control change values.

● System Exclusive Reception

System exclusive data can be received from an external device via a bulk dump operation when the MIDI receive mode is set to "00."

- All panel controls are locked during reception, and all panel settings will be replaced by the received data. Once received, the new panel settings must be recorded to a PAGE MEMORY or they will be lost.
- The data formats of the system exclusive messages are:
F0H -> 43H -> 76H -> 0AH -> BULK DATA -> F7H
- If an error is detected during reception "Err" will appear on the MULTI DISPLAY. If this occurs, try receiving the data again.

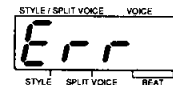

- See "Page Memory MIDI Bulk Dump" on page 15 for details on bulk dump transmission.

● Transmitted Data

The following data is transmitted via the MIDI OUT connector when either the Remote Control or Multi Voice mode is selected:

- The transmit channel for each voice is set using the MIDI CHANNEL button described on page 24.
- All notes played on the keyboard, including velocity data. In the SPLIT mode the left- and right-hand voices are transmitted on their respective transmit channels.
- In the FINGERED or SINGLE FINGER mode, only data corresponding to notes played on the right-hand section of the keyboard is transmitted.
- Transmitted note numbers are affected by the Transpose setting.
- Transmitted note numbers are affected by the octave setting.
- Program change and control change data will not be transmitted if the DUAL function is engaged. Turn DUAL off if you want this data to be transmitted.
- Pitch bend data. The actual pitch bend data range is determined by the pitch bend range setting. If the pitch bend range is set to 12, for example, data from 00H 00H to 7FH 7FH will be transmitted. If the pitch bend range is set to 1, data from 3CH 3AH to 20H 45H will be transmitted.
- The MIDI program change number corresponding to the number of the selected voice is transmitted when a voice is selected.
- MIDI control change messages corresponding to reverb, pan, volume, and sustain are transmitted when these functions are operated. For details refer to * below.
- A MIDI START message is transmitted whenever the rhythm or accompaniment is started, and a MIDI STOP message is transmitted whenever the rhythm or accompaniment is stopped. The same applies to demo and song memory start/stop operations.
- Style, custom style, demo, multi pad, notes added by the auto harmony function, and song memory playback are not transmitted.
- When a VOICE MEMORY button is pressed, the program change and control change data corresponding to that voice is transmitted. The previous panel data is transmitted when a VOICE MEMORY is turned off.

* Control Change Data Value Specifications (receive and transmit, both modes)

Data Format : BnH -> cc -> vv
 BnH: Control Event (n=channel number)
 cc : Control Number
 vv : Control Value

cc=01H ; vibrato

vv= 00H - 0FH : 0 (off)
 10H - 1FH : 1 (min)
 20H - 2FH : 2
 30H - 3FH : 3
 40H - 4FH : 4
 50H - 5FH : 5
 60H - 6FH : 6
 70H - 7FH : 7 (max)

Each voice has its own default value that is used when the voice is initially selected.

cc=07H ; volume

vv= 7FH : 24 (Panel Value ; max)
 01H : 01 (-24dB)
 00H : 00 (no sound)

The default value when no data is being transmitted is 6F (panel value: 21).

cc=0AH ; pan

vv= 00H - 07H : -7 (Left Most)
 08H - 0FH : -6
 10H - 17H : -5
 18H - 1FH : -4
 20H - 27H : -3
 28H - 2FH : -2
 30H - 37H : -1
 38H - 47H : 0 (Center)
 48H - 4FH : 1
 50H - 57H : 2
 58H - 5FH : 3
 60H - 67H : 4
 68H - 6FH : 5
 70H - 77H : 6
 78H - 7FH : 7 (Right Most)

The default value is "center" when no data is being transmitted.

cc=40H ; sustain

vv= 00H - 3FH : off
 40H - 7FH : on

Default is off.

cc=5BH ; reverb

vv= 00H - 07H : 0 (Off)
 08H - 0FH : 1
 10H - 17H : 2
 18H - 1FH : 3
 20H - 27H : 4
 28H - 2FH : 5
 30H - 37H : 6 (Default)
 38H - 3FH : 7
 40H - 47H : 8
 48H - 4FH : 9
 50H - 57H : 10
 58H - 5FH : 11
 60H - 67H : 12
 68H - 6FH : 13
 70H - 77H : 14
 78H - 7FH : 15 (max)

cc=7BH ; all notes off

vv= 00H (fixed)

DEMO

DEMO

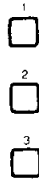

To give you an idea of the PSR-500M's sophisticated capabilities, it is programmed with 3 demonstration songs that you can select and play.

1. Press the DEMO [1], [2], or [3] button to start playback of the corresponding demo.

DEMO

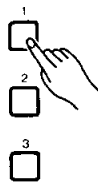

2. Press the same DEMO button a second time or the [START/STOP] button to stop demo playback.
The demonstration will play continuously until the DEMO button is pressed.

* If the MIDI MODE is set to "99," it will be reset to "00" when DEMO playback is started.

APPENDIX A: MIDI BASICS

MIDI, the Musical Instrument Digital Interface, is a world-standard communication interface that allows MIDI-compatible musical instruments and equipment to share musical information and control one another. This makes it possible to create "systems" of MIDI instruments and equipment that offer far greater versatility and control than is available with isolated instruments.

The PSR-500M MIDI Connectors

The PSR-500M MIDI IN connector receives MIDI data from an external MIDI device which can be used to control the PSR-500M. The MIDI OUT connector transmits MIDI data generated by the PSR-500M (e.g. note and velocity data produced by playing the keyboard).

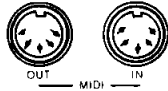

Simple MIDI Control

Most MIDI keyboards (including the PSR-500M, of course) transmit note and velocity (touch response) information via the MIDI OUT connector whenever a note is played on the keyboard. If the MIDI OUT connector is connected to the MIDI IN connector of a second keyboard (synthesizer, etc.) or a tone generator (essentially a synthesizer with no keyboard), the second keyboard or tone generator will respond precisely to notes played on the original transmitting keyboard. The result is that you can effectively play two instruments at once, providing thick multi-instrument sounds. The PSR-500M also transmits "program change" data when one of its voices is selected. Depending on how the receiving device is set up, the corresponding voice will be automatically selected on the receiving keyboard or tone generator whenever a voice is selected on the PSR-500M.

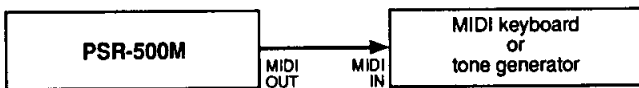

The PSR-500M is capable of receiving the same MIDI data, so a second MIDI keyboard connected to the PSR-500M MIDI IN connector can be used to remotely play the PSR-500M and select voices as required.

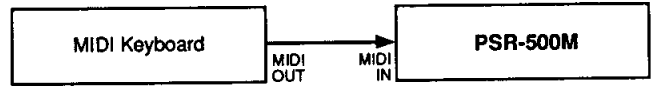

MIDI Sequence Recording

The same type of musical information transfer described above is used for MIDI sequence recording. A MIDI sequence recorder can be used to "record" MIDI data received from a PSR-500M, for example. When the recorded data is played back, the PSR-500M automatically "plays" the recorded performance in precise detail.

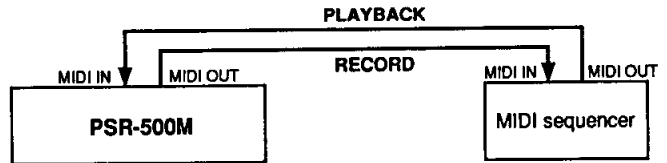

Note: Never use MIDI cables longer than about 15 meters, since cables longer than this can pick up noise which can cause data errors.

MIDI Bulk Dump

MIDI bulk dump operations allow large amounts of MIDI data to be transmitted from one device to another. The entire contents of the PSR-500M PAGE MEMORY, for example, can be dumped to a second PSR-500M or to a bulk storage device such as a MIDI data recorder or MIDI computer.

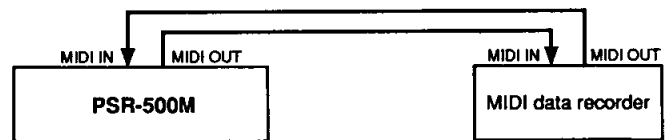

APPENDIX B: POLYPHONY

The PSR-500M features a maximum polyphony of 28-notes, so up to 28 notes can be played on simultaneously. This 28-note maximum applies to all PSR-500M features, including automatic accompaniment, song memory, the multi pads, etc. If more than 28 notes are played at any one time, the extra notes will not sound and "CFull" will appear on the MULTI DISPLAY to indicate that the maximum polyphony has been exceeded.

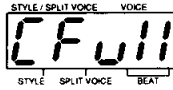

Some of the PSR-500M's voices are actually combinations of two or more voices. These voices therefore only allow half (or less) the normal 28-note maximum. The following is a list of the number of voices used by each of the PSR-500M voices.

VOICE/POLYPHONY LIST

Voice Name	Used Voices	Voice Name	Used Voices	Voice Name	Used Voices
00 PIANO	1	34 CELLO	1	68 SAMBA WHISTLE	1
FLANGE PIANO	2	35 STRINGS 1	2	69 SAX ENSEMBLE 1	2
02 HONKY-TONK PIANO	2	36 STRINGS 2	2	70 SAX ENSEMBLE 2	3
03 ELECTRIC PIANO 1	2	37 ORCHESTRA HIT	1	71 WOODWIND ENSEMBLE	3
04 ELECTRIC PIANO 2	2	38 HARP	1	72 CHORUS	2
05 ELECTRIC PIANO 3	2	39 BANJO	1	73 SYNTH LEAD	2
06 HARPSICHORD 1	1	40 VIBRAPHONE	2	74 SYNTH BRASS	2
07 HARPSICHORD 2	2	41 MARIMBA	1	75 SYNTH STRINGS	2
08 CLAVI	1	42 STEEL DRUM	1	76 SYNTH TOM	1
09 CELESTA	1	43 TRUMPET	1	77 FANTASY 1	4
10 PIPE ORGAN 1	2	44 MUTE TRUMPET 1	2	78 FANTASY 2	2
11 PIPE ORGAN 2	2	45 MUTE TRUMPET 2	1	79 FANTASY 3	4
12 ELECTRONIC ORGAN 1	2	46 MUTE TRUMPET 3	1	80 BELL STRINGS	4
13 ELECTRONIC ORGAN 2	2	47 TROMBONE	1	81 SEQ PAD	3
14 ELECTRONIC ORGAN 3	2	48 FLUGELHORN	1	82 ELECTRIC BASS 1	1
15 ELECTRONIC ORGAN 4	2	49 HORN	1	83 ELECTRIC BASS 2	1
16 ACCORDION 1	2	50 TUBA	1	84 FRETLESS BASS	1
17 ACCORDION 2	2	51 BRASS ENSEMBLE 1	3	85 MUTE BASS	1
18 ELECTRIC GUITAR 1	2	52 BRASS ENSEMBLE 2	3	86 MUTE BASS ECHO	2
19 ELECTRIC GUITAR 2	1	53 PICCOLO	1	87 SLAP BASS	1
ELECTRIC GUITAR 3	1	54 FLUTE	1	88 WOOD BASS 1	1
21 TREMOLO GUITAR	2	55 CLARINET	1	89 WOOD BASS 2	1
22 ELECTRIC 12STRING GUITAR	2	56 BASS CLARINET	1	90 SYNTH BASS 1	1
23 DISTORTION GUITAR	2	57 OBOE	1	91 SYNTH BASS 2	1
24 JAZZ GUITAR	1	58 ENGLISH HORN	1	92 SYNTH BASS 3	1
25 JAZZ GUITAR OCTAVE	2	59 BASSOON	1	93 BOWED BASS	1
26 MUTE GUITAR	1	60 SOPRANO SAX	1	94 SCRATCH W/PITCH	1
27 MUTE GUITAR ECHO	2	61 ALTO SAX	1	95 KICK&SNARE W/PITCH	1
28 STEEL GUITAR	1	62 TENOR SAX	1	96 TOM W/PITCH	1
29 FOLK GUITAR	1	63 BARITONE SAX	1	97 LATIN PERCS W/PITCH	1
30 12STRING GUITAR	2	64 OCARINA	1	98 PERCUSSIONS W/GATE	1
31 GUT GUITAR	1	65 PANFLUTE	1	99 PERCUSSIONS	1
32 VIOLIN 1	1	66 RECORDER	1		
33 VIOLIN 2	1	67 HARMONICA	1		

APPENDIX C: TROUBLESHOOTING

Something not working as it should? In many cases what appears to be a malfunction can be traced to a simple error that can be remedied immediately. Before assuming that your PSR-500M is faulty, please check the following points.

1. PROBLEM

- The PSR-500M speakers produce a “pop” sound whenever the power is turned ON or OFF.

CHECK

- This is normal and is no cause for alarm.

2. PROBLEM

- No sound.

CHECK

- Is the MASTER VOLUME control turned up high enough?
- Is the power turned on? The Auto Power Off function automatically turns off the power if no buttons or keys are pressed for more than about 10 minutes when running the PSR-500M from batteries.
- Are a pair of headphones plugged into the PHONES jack? Have you accidentally plugged the foot pedal into the phones jack?

3. PROBLEM

- Rhythm won't start or no rhythm sound.

CHECK

- Is the accompaniment volume turned up high enough?
- Is the ORCHESTRATION RHYTHM button turned on?
- Are you sure you pressed the START button?
- Perhaps the PSR-500M is in the SYNCHRO START mode, so all you have to do is start playing.

4. PROBLEM

- Auto accompaniment won't function. No lower keyboard sound.

CHECK

- Auto accompaniment won't sound right if the FINGERED mode is selected and you're using SINGLE FINGER type fingering or improper chord fingering.
- Are you sure you're playing in the left-hand section of the keyboard when the FINGERED or SINGLE FINGER mode is selected?
- Are all ORCHESTRATION buttons on?

5. PROBLEM

- Auto accompaniment chords don't seem to change properly.

CHECK

- Are you playing chords that the PSR-500M can recognize (see chord types on page 18)?

6. PROBLEM

- Abnormal operation not listed above. Complete lack of control.

CHECK

- The internal microprocessor may have been “locked up” due to static electricity or other causes. Turn the instrument OFF for a moment, then turn it ON again. If the lock-up makes it impossible to turn the power off, remove the batteries or unplug the AC adaptor. If you turn the power back on within about 10 minute the previous contents of the memory will be safely retained.

7. PROBLEM

- Sustain pedal operation is reversed (press-OFF, release-ON).

CHECK

- You probably held the pedal pressed while turning the power on or inserting the pedal plug into the FOOT PEDAL jack. Turn the power off and then on again with the pedal released.

APPENDIX D: MAINTENANCE

• Location

Avoid exposure to direct sunlight or other sources of heat. Never leave it inside a car where it can get very hot. It may cause discoloration or deformation. Vibration, excessive dust, cold, low or high humidity can also cause malfunction.

• Handling

Avoid rough handling. Don't drop or jolt the PSR-500M as this can damage the internal circuitry. Pressing too hard on keys or controls may lead to malfunctions. When cords are plugged into the rear panel jacks, pay particular attention not to apply excessive force to them since this may damage the terminals or internal circuitry.

• Cleaning

Clean the exterior with a soft, dry cloth. Using chemical solvents may damage the finish.

• Interference Through Electromagnetic Fields

Do not use your PSR-500M close to television sets or other equipment receiving electromagnetic signals as this could cause interference noise in the other appliance.

• Service and Modifications

Your PSR-500M contains no user serviceable parts. Opening it or tampering with it in any way can lead to electrical shock as well as damage. Refer all servicing to qualified YAMAHA personnel.

YAMAHA is NOT responsible for damage caused by improper use.

- APPENDIX E: SYSTEM RESET -

Abnormal operation procedures and other problems can cause the PSR-500M system to "lock up" or malfunction. Normally, simply turning the power off and then on again will solve the problem. If turning the power off and on does not restore normal operation, use the SYSTEM RESET procedure described below (all PAGE MEMORY data is initialized when a SYSTEM RESET is executed: see page 14).

1. Turn the power off.
2. Turn the power on while holding both the CUSTOM [RECORD/END] and [CLEAR] buttons.

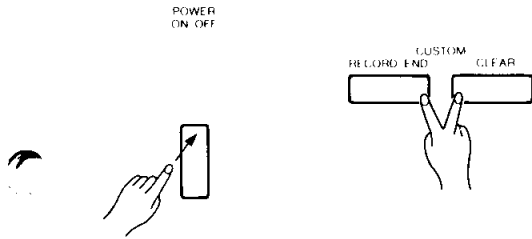

3. The MULTI DISPLAY should appear as shown below, indicating that the SYSTEM RESET has been successful.

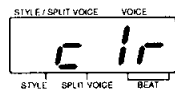

- If the [POWER] button is locked up and cannot be used to turn the power off, unplug and then re-insert the AC adaptor if one is being used, or remove and then replace the batteries.
- If none of the above restores operation, unplug the AC adaptor or remove the batteries for several hours, then try again.

— SPECIFICATIONS —

Keyboard:

61 keys (C1-C6) with Touch Response

Voices:

100 voices
Polyphony; 28

Accompaniment Styles:

103 styles

Demonstrations:

3 songs

Other Controls:

OVERALL CONTROL; POWER (ON/OFF), MODE (NORMAL/SPLIT/SINGLE FINGER/ FINGERED), DSP (OFF/ROOM/HALL) MASTER VOLUME, ACCOMP. VOLUME (PITCH BEND RANGE, +/-), TRANSPOSE (+/-), TUNING (+/-), TEMPO (+/-), SPLIT POINT CHANGE

PAGE MEMORY; RECORD, PAGE (1~4), MIDI BULK DUMP
PITCH BEND

AUTO ACCOMPANIMENT; STYLE SELECT (0~9, +, -, quantize 1/4~1/96), ORCHESTRATION (RHYTHM, BASS, ORCHESTRA 1~3), CUSTOM (RECORD/END, CLEAR)

ACCOMPANIMENT CONTROL; INTRO, FILL IN 1, NORMAL, FILL IN 2, BRIDGE, ENDING, SYNC-START ON/OFF (RHYTHM STOP), START/STOP

VOICE; VOICE SELECT (0~9, +, -), AUTO HARMONY (ON/OFF, +/-), REVERB DEPTH (+/-), VOLUME (+/-), OCTAVE (+/-), PAN (+/-), MIDI CH (+/-), DUAL VOICE (ON/OFF)

VOICE MEMORY; RECORD, 1~4

SONG MEMORY; CHORD (1~5), MELODY (1~5), CONDUCTOR, RECORD/EDIT

SONG MEMORY; PLAY/STOP

MULTI PAD; RECORD/END (TERMINATE), 1~4

MIDI; RECEIVE (ON/OFF), RECEIVE CH/CLOCK (+/-), MODE DEMO; 1~3

Auxiliary Jacks:

HEADPHONES/AUX. OUT, DC (9-12V) IN, FOOT PEDAL, MIDI IN/OUT

Main Amplifiers:

8W x 2 (when using AC power adaptor)
4W x 2 (when using batteries)

Speakers:

12cm (4-3/4") x 2

Rated Voltage:

DC 9~12V

Batteries:

Six SUM-1, "D" size, R-20 or equivalent batteries

AC Power Adaptor:

PA-5

Dimensions (W x D x H):

968mm x 405mm x 136mm (38-1/8" x 15-15/16" x 5-3/8")

Weight:

6.3kg (13.9lbs.) excluding batteries

Supplied Accessories:

- Music Stand
- Yamaha PA-5 AC Power Adaptor
- Foot Pedal
- Owner's Manual

* Specifications subject to change without notice.

- The "Demo Tunes" and "default data of MULTI PAD" of this keyboard are "Demonstration" purposes only. It may not be possible to reproduce the "Demo Tunes" and "default data of MULTI PAD" 100% manually.

INDEX

A

AC power	4
Auto accompaniment	16
volume	11
adding fill-ins	17
bridge variation	17
normal variation	17
starting	16
starting with an introduction	17
stopping	17
Auto harmony	25
Auto power off	10

B

Batteries	4
-----------------	---

C

Chord	
data edit	28
playback	29
sequence recording	28
Chords	
fingered mode	18
single-finger mode	18
Conductor	30
Custom style	19

D

Demo	35
Drum/percussion key assignments	22
DSP	11
Dual voice	24

F

Fingered mode	18, 11
Foot pedal	5

H

Hall effect	11
Headphones	5
Headphones/Aux Out jack	5

K

Keyboard percussion	21
---------------------------	----

M

Maintenance	38
Manual, how to use	1
Master volume control	11
Melody	
data edit	27
playback	29
recording	26

MIDI

bulk dump	15, 36
channel	24
clock	32
connectors	36
control change data	34
control, description	36
multi voice mode	33
receive channel	32
remote control mode	32
sequence recording	36
system exclusive data reception	33
transmit data	34
Mode	10
Multi pads	31
Music stand	5

N

Nomenclature	3
Normal mode	10

O

Octave	24
Orchestration	19

P

Page memory	
data	13
initial settings	14
recall	14
recording	13

Pan	24
Pitch bend	11
range	12
Polyphony	37
Power button	10

Q

Quantization	20
--------------------	----

R

Reverb depth	23
Room effect	11

S

Single finger mode	18, 11
Song memory	26
Specifications	39
Split mode	23, 10
changing voices	23
Split point change	13
Style select	16
System reset	39

T

Tempo	12
Transpose	12
Troubleshooting	38
Tuning	12

V

Voice	
list with polyphony	37
memory	25
select	21
Volume	
accompaniment	11
master	11
voice	23

Function		Transmitted	Recognized		Remarks
			Remote Control Mode	Multi Voice Mode	
Basic Channel	Default Changed	1-16 (*1) 1-16	1-16 (*2) 1-16 (*2)	1-16 (*2) 1-16 (*2)	
Mode	Default Messages Altered	3 × *****	(*2) × ×	(*2) (*3) × ×	
Note Number	: True voice	0-127 *****	0-127 0-127 (*4)	0-127 0-127 (*4)	
Velocity	Note ON Note OFF	○ 9nH, v = 1-127 × 9nH, v = 0	○ 9nH, v = 1-127 × 9nH, v = 0 or 8nH	○ 9nH, v = 1-127 × 9nH, v = 0 or 8nH	
After Touch	Key's Ch's	× ×	× ×	× ×	
Pitch Bender		○ (*5)	○ (*6)	○ (*6)	7 bit resolution
Control Change	01 07 10 64 91	× ○ ○ ○ ○	○ ○ ○ ○ ○	○ ○ ○ ○ ○	Vibrato Volume Pan Sustain Reverb Depth
Program Change	: True #	○ 0-99, 124-127 (*7) *****	○ 0-99 0-99 (*7)	○ 0-99 0-99 (*7)	
System Exclusive		○ (*8)	○ (*8)	×	
System Common	: Song Pos : Song Scl : Tune	× × ×	× × ×	× × ×	
System Real Time	: Clock : Commands	○ ○	(*9) ○	× ×	START, STOP
Aux Messages	: Local ON/OFF : All Notes OFF : Active Sense : Reset	× × ○ ×	× ○ ○ ×	× ○ ○ ×	

Notes : *1: Memorized
*2: Each Channel can be set ON or OFF individually.
*3: Multi Timbre. Dynamic Voice Allocation
*4: Some voice is replaced by sine wave above a certain pitch.
*5: Data range is altered by the pitch bend range of panel setting.
i.e. Pitch bend range: 12 00H, 00H, to 7FH, 7FH
Pitch bend range: 1 3CH, 3AH, to 20H, 45H
*6: Pitch bend range of panel setting is applied.
*7: 0-99 = voice number
*8: Page memory bulk dump
*9: Possible to set ON/OFF manually.

Mode 1 : OMNI ON, POLY Mode 2 : OMNI ON, MONO
Mode 3 : OMNI OFF, POLY Mode 4 : OMNI OFF, MONO

○ : Yes
× : No

SPECIAL MESSAGE SECTION

This product utilizes batteries or an external power supply (adapter). DO NOT connect this product to any power supply or adapter other than one described in the manual, on the name plate, or specifically recommended by Yamaha.

This product should be used only with the components supplied or; a cart, rack, or stand that is recommended by Yamaha if a cart, etc., is accompany the accessory product.

SPECIFICATIONS SUBJECT TO CHANGE:

The information contained in this manual is believed to be correct at the time of printing. However, Yamaha reserves the right to change or modify any of the specifications without notice or obligation to update existing units.

This product, either alone or in combination with an amplifier and headphones or speaker/s, may be capable of producing sound levels that could cause permanent hearing loss. DO NOT operate for long periods of time at a high volume level or at a level that is uncomfortable. If you experience any hearing loss or ringing in the ears, you should consult an audiologist. **IMPORTANT:** The louder the sound, the shorter the time period before damage occurs.

NOTICE:

Service charges incurred due to a lack of knowledge relating to how a function or effect works (when the unit is operating as designed) are not covered by the manufacturer's warranty, and are therefore the owners responsibility. Please study this manual carefully and consult your dealer before requesting service.

ENVIRONMENTAL ISSUES:

Yamaha strives to produce products that are both user safe and environmentally friendly. We sincerely believe that our products and the production methods used to produce them, meet these goals. In keeping with both the letter and the spirit of the law, we want you to be aware of the following:

Battery Notice: This product MAY contain a small non-rechargeable battery which (if applicable) is soldered in place. The average life span of

this type of battery is approximately five years. When replacement becomes necessary, contact a qualified service representative to perform the replacement.

This product may also use "household" type batteries. Some of these may be rechargeable. Make sure that the battery being charged is a rechargeable type and that the charger is intended for the battery being charged.

When installing batteries, do not mix batteries with new, or with batteries of a different type. Batteries **MUST** be installed correctly. Mismatches or incorrect installation may result in overheating and battery case rupture.

Warning: Do not attempt to disassemble, or incinerate any battery. Keep all batteries away from children. Dispose of used batteries promptly and as regulated by the laws in your area. Note: Check with any retailer of household type batteries in your area for battery disposal information.

Disposal Notice: Should this product become damaged beyond repair, or for some reason its useful life is considered to be at an end, please observe all local, state, and federal regulations that relate to the disposal of products that contain lead, batteries, plastics, etc. If your dealer is unable to assist you, please contact Yamaha directly.

NAME PLATE LOCATION:

The name plate is located on the bottom of the product. The model number, serial number, power requirements, etc., are located on this plate. You should record the serial number and the date of purchase in the spaces provided below and retain this manual as a permanent record of your purchase.

Model PSR-500M

Serial No. _____

Purchase Date _____

FCC INFORMATION (U.S.A.)

1. IMPORTANT NOTICE: DO NOT MODIFY THIS UNIT!

This product, when installed as indicated in the instructions contained in this manual, meets FCC requirements. Modifications not expressly approved by Yamaha may void your authority, granted by the FCC, to use the product.

2. IMPORTANT:

When connecting this product to accessories and/or another product use only high quality shielded cables. Cable/s supplied with this product **MUST** be used. Follow all installation instructions. Failure to follow instructions could void your FCC authorization to use this product in the USA.

3. NOTE:

This product has been tested and found to comply with the requirements listed in FCC Regulations, Part 15 for Class "B" digital devices. Compliance with these requirements provides a reasonable level of assurance that your use of this product in a residential environment will not result in harmful interference with other electronic devices. This equipment generates/uses radio frequencies and, if not installed and used according to the instructions found in the users manual, may cause interference harmful to the operation of other electronic devices. Compliance with FCC regulations does not guarantee that interference will not occur in all installations. If this product is found to be the source of interference, which can be determined by turning the unit "OFF" and "ON", please try to eliminate the problem by using one of the following measures:

Relocate either this product or the device that is being affected by the interference.

Utilize power outlets that are on different branch (circuit breaker or fuse) circuits or install AC line filter/s.

In the case of radio or TV interference, relocate/reorient the antenna. If the antenna lead-in is 300 ohm ribbon lead, change the lead-in to co-axial type cable.

If these corrective measures do not produce satisfactory results, please contact the local retailer authorized to distribute this type of product. If you can not locate the appropriate retailer, please contact Yamaha Corporation of America, Electronic Service Division, 6600 Orangethorpe Ave, Buena Park, CA90620

The above statements apply **ONLY** to those products distributed by Yamaha Corporation of America or its subsidiaries.

• This applies only to products distributed by Yamaha Corporation of America.

YAMAHA

IMPORTANT

PLEASE RECORD THE SERIAL NUMBER OF YOUR UNIT IN THE SPACE BELOW.

MODEL: PSR-500M

SERIAL NO:

THE SERIAL NUMBER IS LOCATED ON THE BOTTOM OF THE UNIT.
RETAIN THIS OWNER'S GUIDE IN A SAFE PLACE FOR FUTURE
REFERENCE.