



USB MIXING STUDIO

MW12cx

MW12c

Owner's Manual
Bedienungsanleitung
Mode d'emploi
Manual de instrucciones



English

Deutsch

Français

Español



EN
DE
FR
ES

IMPORTANT NOTICE FOR THE UNITED KINGDOM

Connecting the Plug and Cord

IMPORTANT. The wires in this mains lead are coloured in accordance with the following code:

BLUE : NEUTRAL
BROWN : LIVE

As the colours of the wires in the mains lead of this apparatus may not correspond with the coloured markings identifying the terminals in your plug proceed as follows:

The wire which is coloured BLUE must be connected to the terminal which is marked with the letter N or coloured BLACK.

The wire which is coloured BROWN must be connected to the terminal which is marked with the letter L or coloured RED.

Making sure that neither core is connected to the earth terminal of the three pin plug.

* This applies only to products distributed by Yamaha-Kemble Music (U.K.) Ltd.

(2 wires)

COMPLIANCE INFORMATION STATEMENT (DECLARATION OF CONFORMITY PROCEDURE)

Responsible Party : Yamaha Corporation of America
Address : 6600 Orangethorpe Ave., Buena Park, Calif. 90620
Telephone : 714-522-9011
Type of Equipment : USB Mixing Studio
Model Name : MW12CX/MW12C

This device complies with Part 15 of the FCC Rules.

Operation is subject to the following two conditions:

- 1) this device may not cause harmful interference, and
- 2) this device must accept any interference received including interference that may cause undesired operation.

See user manual instructions if interference to radio reception is suspected.

* This applies only to products distributed by YAMAHA CORPORATION OF AMERICA.

(FCC DoC)

FCC INFORMATION (U.S.A.)

1. IMPORTANT NOTICE: DO NOT MODIFY THIS UNIT!

This product, when installed as indicated in the instructions contained in this manual, meets FCC requirements. Modifications not expressly approved by Yamaha may void your authority, granted by the FCC, to use the product.

2. IMPORTANT:

When connecting this product to accessories and/or another product use only high quality shielded cables. Cable/s supplied with this product MUST be used. Follow all installation instructions. Failure to follow instructions could void your FCC authorization to use this product in the USA.

3. NOTE:

This product has been tested and found to comply with the requirements listed in FCC Regulations, Part 15 for Class "B" digital devices. Compliance with these requirements provides a reasonable level of assurance that your use of this product in a residential environment will not result in harmful interference with other electronic devices. This equipment generates/uses radio frequencies and, if not installed and used according to the instructions found in the users manual, may cause interference harmful to the operation of other electronic devices. Compliance with FCC regula-

tions does not guarantee that interference will not occur in all installations. If this product is found to be the source of interference, which can be determined by turning the unit "OFF" and "ON", please try to eliminate the problem by using one of the following measures:

Relocate either this product or the device that is being affected by the interference.

Utilize power outlets that are on different branch (circuit breaker or fuse) circuits or install AC line filter/s.

In the case of radio or TV interference, relocate/reorient the antenna. If the antenna lead-in is 300 ohm ribbon lead, change the lead-in to co-axial type cable.

If these corrective measures do not produce satisfactory results, please contact the local retailer authorized to distribute this type of product. If you can not locate the appropriate retailer, please contact Yamaha Corporation of America, Electronic Service Division, 6600 Orangethorpe Ave, Buena Park, CA90620

The above statements apply ONLY to those products distributed by Yamaha Corporation of America or its subsidiaries.

* This applies only to products distributed by YAMAHA CORPORATION OF AMERICA.

(class B)

이 기기는 가정용(B급) 전자파적
합기기로서 주로 가정에서 사용하는 것을 목적
으로 하며, 모든 지역에서 사용할 수 있습니다.

(class b korea)

PRECAUTIONS

PLEASE READ CAREFULLY BEFORE PROCEEDING

* Please keep this manual in a safe place for future reference.



WARNING

Always follow the basic precautions listed below to avoid the possibility of serious injury or even death from electrical shock, short-circuiting, damages, fire or other hazards. These precautions include, but are not limited to, the following:

Power supply/Power cord

- Only use the voltage specified as correct for the device. The required voltage is printed on the name plate of the device.
- Use only the included AC power adaptor (PA-20 or an equivalent recommended by Yamaha).
- Do not place the power cord near heat sources such as heaters or radiators, and do not excessively bend or otherwise damage the cord, place heavy objects on it, or place it in a position where anyone could walk on, trip over, or roll anything over it.

Do not open

- Do not open the device or attempt to disassemble the internal parts or modify them in any way. The device contains no user-serviceable parts. If it should appear to be malfunctioning, discontinue use immediately and have it inspected by qualified Yamaha service personnel.

Water warning

- Do not expose the device to rain, use it near water or in damp or wet conditions, or place containers on it containing liquids which might spill into any openings.
- Never insert or remove an electric plug with wet hands.

If you notice any abnormality

- If the power cord or plug becomes frayed or damaged, or if there is a sudden loss of sound during use of the device, or if any unusual smells or smoke should appear to be caused by it, immediately turn off the power switch, disconnect the electric plug from the outlet, and have the device inspected by qualified Yamaha service personnel.
- If this device or the AC power adaptor should be dropped or damaged, immediately turn off the power switch, disconnect the electric plug from the outlet, and have the device inspected by qualified Yamaha service personnel.



CAUTION

Always follow the basic precautions listed below to avoid the possibility of physical injury to you or others, or damage to the device or other property. These precautions include, but are not limited to, the following:

Power supply/Power cord

- Remove the electric plug from the outlet when the device is not to be used for extended periods of time, or during electrical storms.
- When removing the electric plug from the device or an outlet, always hold the plug itself and not the cord. Pulling by the cord can damage it.
- To avoid generating unwanted noise, make sure there is adequate distance (50 cm or more) between the AC power adaptor and the device.
- Do not cover or wrap the AC power adaptor with a cloth or blanket.

Location

- Before moving the device, remove all connected cables.
- When setting up the device, make sure that the AC outlet you are using is easily accessible. If some trouble or malfunction occurs, immediately turn off the power switch and disconnect the plug from the outlet. Even when the power switch is turned off, electricity is still flowing to the product at the minimum level. When you are not using the product for a long time, make sure to unplug the power cord from the wall AC outlet.
- Avoid setting all equalizer controls and faders to their maximum. Depending on the condition of the connected devices, doing so may cause feedback and may damage the speakers.
- Do not expose the device to excessive dust or vibrations, or extreme cold or heat (such as in direct sunlight, near a heater, or in a car during the day) to prevent the possibility of panel disfiguration or damage to the internal components.

- Do not place the device in an unstable position where it might accidentally fall over.
- Do not use the device in the vicinity of a TV, radio, stereo equipment, mobile phone, or other electric devices. Doing so may result in noise, both in the device itself and in the TV or radio next to it.

Connections

- Before connecting the device to other devices, turn off the power for all devices. Before turning the power on or off for all devices, set all volume levels to minimum.

Handling caution

- When turning on the AC power in your audio system, always turn on the power amplifier LAST, to avoid speaker damage. When turning the power off, the power amplifier should be turned off FIRST for the same reason.
- Do not insert your fingers or hands in any gaps or openings on the device.
- Avoid inserting or dropping foreign objects (paper, plastic, metal, etc.) into any gaps or openings on the device. If this happens, turn off the power immediately and unplug the power cord from the AC outlet. Then have the device inspected by qualified Yamaha service personnel.
- Do not use the device or headphones for a long period of time at a high or uncomfortable volume level, since this can cause permanent hearing loss. If you experience any hearing loss or ringing in the ears, consult a physician.
- Do not rest your weight on the device or place heavy objects on it, and avoid use excessive force on the buttons, switches or connectors.

XLR-type connectors are wired as follows (IEC60268 standard): pin 1: ground, pin 2: hot (+), and pin 3: cold (-).
Insert TRS phone jacks are wired as follows: sleeve: ground, tip: send, and ring: return.

Yamaha cannot be held responsible for damage caused by improper use or modifications to the device, or data that is lost or destroyed.

Always turn the power off when the device is not in use.

Even when the power switch is in the "STANDBY" position, electricity is still flowing to the device at the minimum level. When you are not using the device for a long time, make sure you unplug the power cord from the wall AC outlet.

The performance of components with moving contacts, such as switches, volume controls, and connectors, deteriorates over time. Consult qualified Yamaha service personnel about replacing defective components.

The MW mixer may heat up by as much as 15 to 20°C while the power is on. This is normal. Please note that the panel temperature may exceed 50°C in ambient temperatures higher than 30°C, and use caution to prevent burns.

* This Owner's Manual applies to both the MW12CX and MW12C. The main difference between the two models is that the MW12CX includes digital effects while the MW12C has no internal effects.

* In this manual the term "MW mixers" refers to both the MW12CX and MW12C. In cases where different features need to be described for each model, the MW12CX feature will be described first, followed by the MW12C feature in brackets: MW12CX (MW12C).

SPECIAL NOTICES

- The owner's manual is the exclusive copyright of Yamaha Corporation.
- The included software is the exclusive copyright of Steinberg Media Technologies GmbH.
- Copying of the software or reproduction of this manual in whole or in part by any means is expressly forbidden without the written consent of the manufacturer.
- Yamaha makes no representations or warranties with regard to the use of the software and documentation and cannot be held responsible for the results of the use of this manual and the software.
- This disk is a DVD-ROM. Do not attempt to play the disk on a DVD player. Doing so may result in irreparable damage to your DVD player.
- Visit the web address below for the latest information on supplied software and operating system requirements.
<<http://www.yamahasynth.com/>>

The illustrations and LCD screens as shown in this owner's manual are for instructional purposes only, and may appear somewhat different from those on your instrument.

This product incorporates and bundles computer programs and contents in which Yamaha owns copyrights or with respect to which it has license to use others' copyrights. Such copyrighted materials include, without limitation, all computer software, style files, MIDI files, WAVE data, musical scores and sound recordings. Any unauthorized use of such programs and contents outside of personal use is not permitted under relevant laws. Any violation of copyright has legal consequences. DON'T MAKE, DISTRIBUTE OR USE ILLEGAL COPIES.

Copying of the commercially available musical data including but not limited to MIDI data and/or audio data is strictly prohibited except for your personal use.

- Windows is the registered trademarks of Microsoft® Corporation.
- Apple, Mac and Macintosh are trademarks of Apple Computer, Inc., registered in the U.S. and other countries.
- Steinberg and Cubase are the registered trademarks of Steinberg Media Technologies GmbH.
- The company names and product names in this Owner's Manual are the trademarks or registered trademarks of their respective companies.

Specifications and descriptions in this owner's manual are for information purposes only. Yamaha Corp. reserves the right to change or modify products or specifications at any time without prior notice. Since specifications, equipment or options may not be the same in every locale, please check with your Yamaha dealer.

Introduction

Thank you for choosing a Yamaha MW12CX/MW12C USB Mixing Studio. The MW12CX/MW12C includes an audio mixer equipped with a USB interface for digital audio data transfer, and Cubase AI DAW (Digital Audio Workstation) software for Windows® and Macintosh® computer operating systems. With the MW12CX/MW12C USB Mixing Studio and your personal computer you have the basic elements of a high-performance computer recording system that is easy to set up and operate.

Please read through this manual carefully before beginning use, so that you will be able to take full advantage of your mixer's superlative features and enjoy trouble-free operation for years to come. After reading the manual, please store it in a safe place.

Features

Connect To Your Computer via a Single USB Cable (page 7)

The MW mixer connects to your computer via the supplied USB cable. Stereo audio data is transferred in both directions—from the mixer to the computer, and vice-versa—via the USB connection (44.1 kHz or 48 kHz sampling frequency).

No Driver Installation Required (page 7)

The MW system uses the standard drivers included in your computer's operating system, so there's no need to install any extra driver software.

Cubase AI DAW Software Supplied (page 7)

Cubase AI software, included in the MW package, offers versatile, high-performance hard-disk recording capability.

Compression (page 9)

Compression increases the overall level without introducing distortion by compressing excessive peaks in the signals from microphones and guitars.

Mixer Functions (page 16)

The MW mixer can handle up to 12 simultaneous inputs, mixing them to STEREO OUT or REC OUT. You could connect four microphones and four stereo sources, or six microphones and two stereo sources, for example. AUX SEND connectors are provided for convenient connection to external signal processors or other equipment.

48V Phantom Power (page 19)

A PHANTOM switch supplies +48V phantom power to the mixer's microphone inputs, so you can use high-quality phantom-powered condenser microphones for superior recording quality.

Accessories

- Cubase AI DVD-ROM
- Power adaptor (PA-20)*
- USB cable
- Owner's Manual (this book)

* May not be included depending on your particular area. Please check with your Yamaha dealer.

Contents

Introduction.....	5
Features	5
Contents.....	5
Before Turning on the Mixer.....	6
Turning the Power On/OFF.....	6
■ Mixer Basics.....	7
Quick Guide	7
1. Installing Cubase AI	7
2. Connecting to the MW mixer.....	7
3. Powering Up the System	8
4. Adjusting Level and Tone	9
5. Recording with Cubase AI	10
6. Mixing with Cubase AI	13
■ Reference	15
Setup.....	15
Front & Rear Panels	16
Channel Control Section	16
Master Control Section.....	18
Digital Effect.....	20
Rear Input/Output Section.....	20
Digital Effect Program List.....	21
Jack List	21
Troubleshooting	22
Specifications	91
Electrical Specifications	91
General Specifications	91
Analog Input Specifications.....	92
Analog Output Specifications	92
Digital Input/Output Specifications	92
Dimensional Diagrams	93
Block Diagram and Level Diagram.....	94
About the accessory disk.....	95

Before Turning on the Mixer

- 1 Be sure that the mixer's power switch is in the **STANDBY** position.



CAUTION

Use only the included power adaptor (PA-20) or an equivalent recommended by Yamaha. Use of a different adaptor may result in equipment damage, overheating, or fire.

- 2 Connect the power adaptor to the **AC ADAPTOR IN** connector (1) on the rear of the mixer, and then turn the fastening ring clockwise (2) to secure the connection.

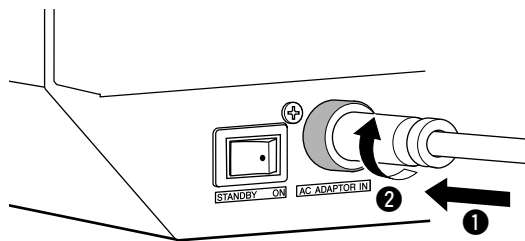

- 3 Plug the power adaptor into a standard household power outlet.



CAUTION

- Be sure to unplug the adaptor from the outlet when not using the mixer, or when there are lightning storms in the area.
- To avoid generating unwanted noise, make sure there is 50 cm or more between the power adaptor and the mixer.

Turning the Power On/OFF

Press the mixer's power switch to the **ON** position. When you are ready to turn the power off, press the power switch to the **STANDBY** position.



CAUTION

Note that trace current continues to flow while the switch is in the **STANDBY** position. If you do not plan to use the mixer again for a long while, please be sure to unplug the adaptor from the wall outlet.

NOTE To prevent loud pops and noises, turn on the power to your sound gear starting with the sources (instruments, CD players, etc.) and ending with the power amplifier or powered speakers.

Example : Instruments, microphones, and CD players first, then the mixer, and finally the power amplifier or powered speakers.

When turning off the power to the system, reverse the order described above.

Quick Guide

This quick setup and operation guide covers everything from installing the Cubase AI software to using Cubase AI for recording and mixdown. While going through this section you might find it useful to also refer to the “Front and Rear Panels” section on page 16, as well as the pdf manual supplied with the Cubase AI software.

Step

1 Installing Cubase AI

Important!

You are only permitted to use this software pursuant to the terms and conditions of the “Steinberg Software End User License Agreement (EULA)” shown during the installation.

- 1** Start the computer and log on to the Administrator account.
- 2** Insert the included DVD-ROM into the computer’s DVD-ROM drive.
- 3** Follow the on-screen instructions to install the Cubase AI software.

NOTE

- In order to have continuous use of Cubase AI, including support and other benefits, you will need to register the software and activate your software license by starting it while the computer is connected to the Internet. Click the “Register Now” button shown when the software is started, then fill in all required fields for registration. If you do not register the product, you will be unable to use the application after a limited period of time expires.
- To install on Mac computers double-click the “Cubase AI*.mpkg” icon or the “Cubase AI* Start Center” icon. “*” indicates where the version number appears in the actual icon name.
- Visit the web address below for the latest information on:
<<http://www.yamahasyth.com/>>

Step

2 Connecting to the MW mixer

- 1** Turn the power to the MW mixer and all gear that is to be connected to the MW mixer off/standby (except the computer), and set the channel faders, STEREO OUT Master fader, and REC OUT fader to their minimum settings.

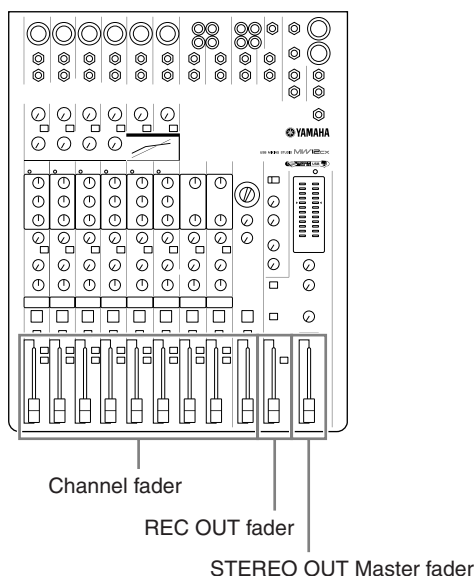

- 2** Connect the MW mixer to your computer using the supplied USB cable.

USB Connection Precautions

Be sure to observe the following points when connecting to the computer’s USB interface.

Failure to observe these rules can result in computer freezes/hang-ups and possibly data loss or corruption. If the MW mixer or computer does hang up, turn the power to both devices off and then on again, and restart the computer.



- Be sure to wake the computer from sleep/suspended/standby mode before making a connection to the computer’s USB connector.
- Connect the MW mixer to the computer before turning the MW mixer power on.
- Always quit all applications running on the computer before turning the MW mixer’s power on or off, or connecting or disconnecting the USB cable.
- Wait at least 6 seconds between turning the MW mixer on or off, and between connecting or disconnecting the USB cable.



When connecting or disconnecting the USB cable be sure to turn the 2TR IN/USB control all the way down.

NOTE

Disconnect the USB cable when using the MW mixer without the computer.

3 Connecting Microphones and/or Instruments.

For details on making connections refer to the “Setup” section on page 15 and the “Front & Rear Panels” section on page 16.

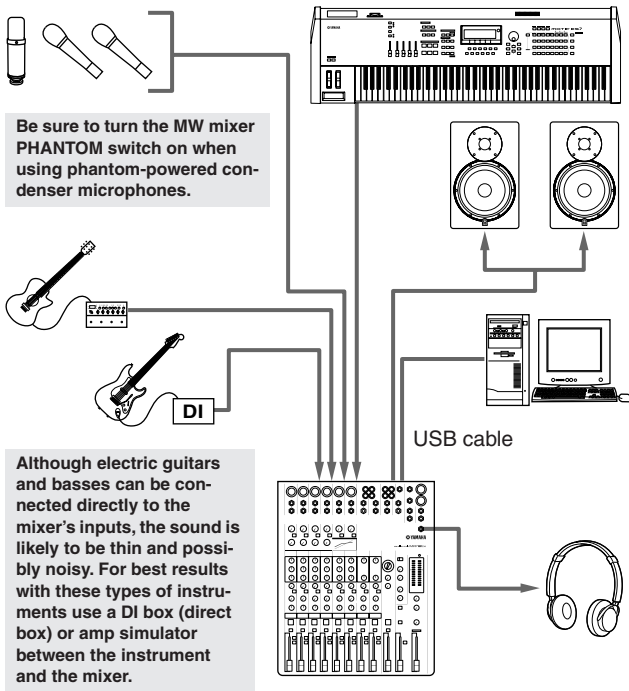

Be sure to turn the MW mixer PHANTOM switch on when using phantom-powered condenser microphones.

Although electric guitars and basses can be connected directly to the mixer's inputs, the sound is likely to be thin and possibly noisy. For best results with these types of instruments use a DI box (direct box) or amp simulator between the instrument and the mixer.

Step 3 Powering Up the System

To prevent loud pops and noises, turn on the power to your sound gear starting with the sources (instruments, CD players, etc.) and ending with the power amplifier or powered speakers.

Example : Instruments, microphones, and CD players first, then the mixer, and finally the power amplifier or powered speakers.



Observe the following precautions when turning on phantom power.

- Make sure that the PHANTOM switch is off when phantom power is not needed.
- When turning the switch on, be sure that only condenser microphones are connected to the XLR input jacks. Other devices may be damaged if connected to phantom power. This precaution does not apply to balanced dynamic microphones, however, as these will not be affected by phantom power.
- To minimize the possibility of speaker damage, turn phantom power on ONLY while your power amplifier or powered speakers are switched off. It's also a good idea to turn the mixer's output controls—STEREO OUT Master fader and REC OUT fader—all the way down.

NOTE

- We recommend that you set the computer output to the maximum level and mute the computer's internal speaker. For details on how to make the setting refer to the “The recorded sound is too low in level.” in the “Troubleshooting” on page 22.
- The first time you connect to the computer's USB connector, or change the connection to a different USB port, a driver installation display may appear after turning the power to the MW mixer on. If this occurs, wait until the installation is complete before proceeding.

Balanced Cables and Unbalanced Cables

Two types of cables can be used to connect microphones, electronic instruments, and other audio sources to the mixer's inputs, as well as to connect the mixer's outputs to a power amplifier or related gear: balanced or unbalanced. Balanced cables are highly resistant to noise, and are the best choice for low-level signals such as the output from microphones, as well as for long cable runs. Unbalanced cables are generally used for short runs from line-level sources such as synthesizers.

Cable Guidelines

Microphone cable	Balanced is best.
Short line-level cables	Unbalanced cable is fine in a relatively noise-free environment.
Long line-level cables	Balanced is best.

Connector Types

XLR Connectors

This 3-pin connector is resistant to externally induced noise, and is used primarily for balanced connections. With properly designed receiving circuitry cables with this type of connector can also be used for unbalanced signals. XLR type connectors are the standard for microphone connections as well as most professional audio gear.

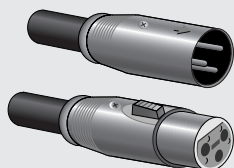

Phone Connectors

Phone connectors are available in mono and stereo versions. Stereo types are also known as “TRS” connectors (Tip-Ring-Sleeve), and are used for stereo headphone jacks, insert jacks, and also to carry balanced signals in many cases. Unbalanced types are used for mono signals -guitar cables are a common example.

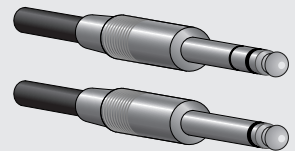

RCA Pin Connectors

This type of unbalanced connector is most commonly found on home audio and video equipment. RCA type pin jacks are often color coded: white for left audio channel and red for right audio channel, for example.

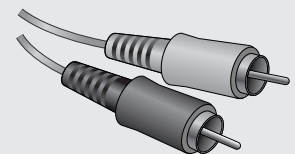

Step 4 Adjusting Level and Tone

Level Adjustment

- 1** The first step is to set the level controls on all instruments and other sources appropriately.
- 2** Adjust the channel GAIN controls so that the corresponding PEAK indicators flash briefly on the highest peak levels. (GAIN controls are not provided on the stereo channels—9/10 and 11/12).
- 3** Engage the ON and REC switches of the input channels that you would like to record.
- 4** Make sure that the PFL switch is off (■), and that the MONITOR switch is set to REC (—).
- 5** Raise the REC OUT fader to the 0 dB position.
- 6** Set the channel faders to create the desired initial balance while monitoring via headphones or monitor speakers. The overall headphone level is adjusted by the PHONES control.

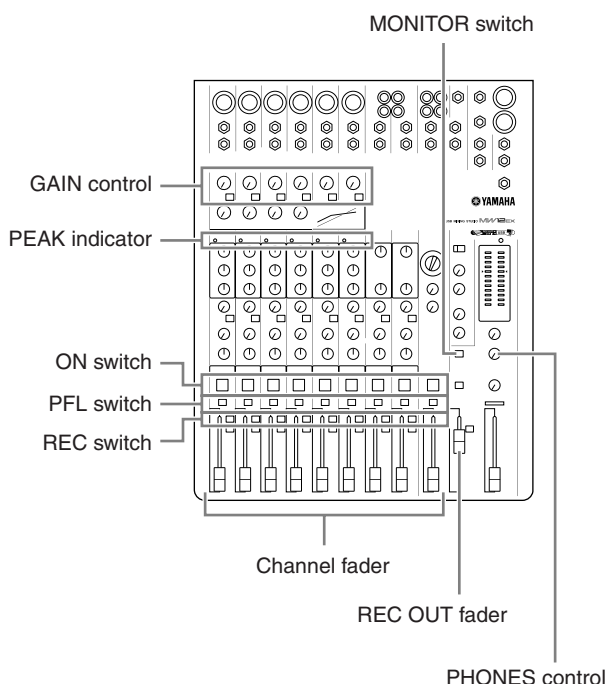

Tone Adjustment

The MW mixer's compressors and 3-band equalizers make it easy to shape the tone of independent channels to achieve the best possible mix.

Use the High-pass Filter for Microphone Input

As the name implies, a "high-pass filter" allows only signals above a certain frequency to pass. Conversely, signals below that "cutoff frequency" are attenuated. When an MW high-pass filter is turned on, signals below 80 Hz are attenuated. This can be useful for minimizing low-frequency breath noise from a vocalist, as well as handling noise, or rumble transmitted via the microphone stand. It is generally a good idea to turn the high-pass filter on for microphone channels.

Compression

One form of compression known as "limiting" can, when properly used, produce a smooth, unified sound with no excessive peaks or distortion. A common example of the use of compression is to "tame" a vocal that has a wide dynamic range in order to tighten up the mix. Compression can also be applied to guitar tracks to add extra sustain. Too much compression can be a cause of feedback, however, so use it sparingly.

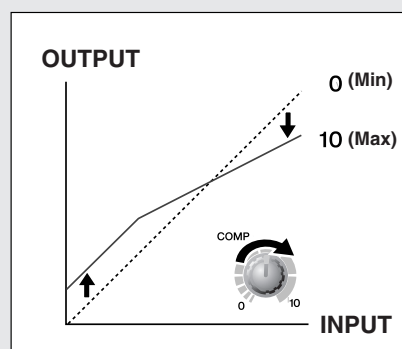

Equalizer Tips

The best advice that can be given regarding equalization while recording is simply to use as little equalization as possible. If you want a little more presence you can turn the HIGH end up a bit. Or you can boost the bass a little if you feel the low end is lacking. During recording it's better to use EQ sparingly for compensation only.

Step 5 Recording with Cubase AI

This section describes the procedure for recording to the Cubase AI software we installed earlier via the MW mixer.

NOTE Cubase AI 6 is used for the examples in this manual. For details about other versions of Cubase AI or Cubase AI operation in general, refer to the PDF manual provided with the software.

Cubase AI Setup

1 Launch Cubase AI.

Windows:

Click [Start] → [All Program] → [Steinberg Cubase AI *] → [Cubase AI *] to launch the program. (“*” indicates where the version number appears in the actual icon name.)

NOTE If the ASIO Direct Sound Full Duplex Driver dialog window appears, click [OK].

Mac:

Double-click the [Application] → [Cubase AI *].

“*” indicates where the version number appears in the actual icon name.

NOTE

- If you specified a file destination when installing the Cubase AI software, launch the application from that location.
- Create a Cubase AI shortcut or alias on your desktop so you can easily launch the program when required.

2 When the Project Assistant window appears, select the [More] menu → [Empty] and click [Create].



A new project is created.

NOTE Recorded Cubase AI data is stored as a “Project.”

3 Select [Device Setup] from the [Devices] menu to open the Device Setup window.

Windows:

Select [VST Audio System] in the [Devices] field on the left side of the window. Select [ASIO DirectX Full Duplex Driver] in the [ASIO Driver] field on the right side of the window. A dialog box will appear asking “Do you want to switch the ASIO driver?”. Click [Switch].

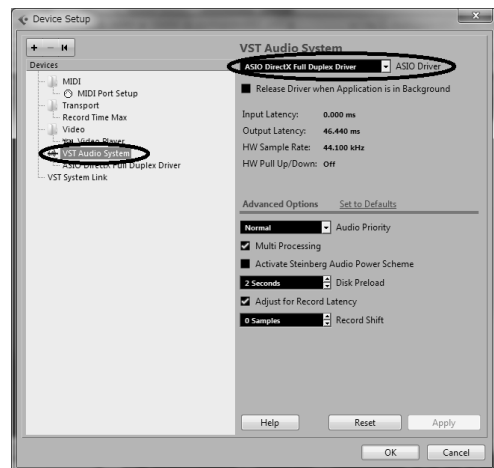

Mac:

Select [VST Audio System] in the [Devices] field on the left side of the window. Select [USB Audio CODEC] in the [ASIO Driver] field on the right side of the window. A dialog box will appear asking “Do you want to switch the ASIO driver?”. Click [Switch].

- 4 Select [ASIO DirectX Full Duplex Driver] (Windows), [USB Audio CODEC] (Mac) in the [Devices] field on the left side of the Device Setup window, and click [Control Panel] on the right side of the window.

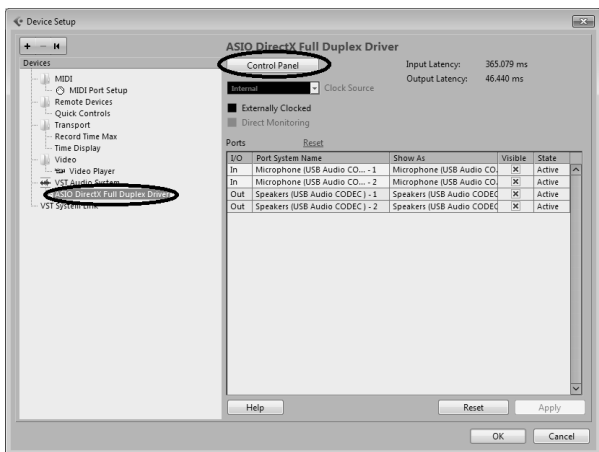

Windows:

The ASIO Direct Sound Full Duplex Setup dialog box will be displayed. Check only the input port and output port [USB Audio CODEC] checkbox, and then click [OK] to close the dialog window.

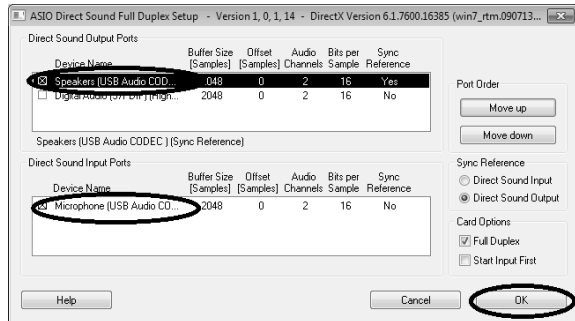

Mac:

The [CoreAudio Device Settings] dialog window appears. Check only the [USB Audio CODEC] checkbox in both “Input” and “Output” of the [Input/Output Configuration] field. Click [Close] to close the dialog window.

- 5 Make sure that “USB Audio CODEC 1/2” (Windows), “Front Left/Front Right” (Mac) are shown in the [Port System Name] field, and check the [Visible] column in the Device Setup window. Click [OK] to close the window.

NOTE If the [Port System Name] field does not change, close and restart the Cubase AI, then open the Device Setup window.

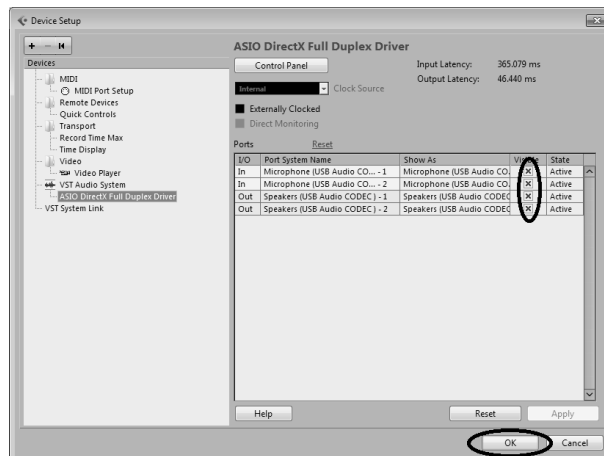

- 6 Select [VST Connections] from the [Devices] menu.

Windows:

If “Not Connected” is selected in the [Audio Device] field, click on the “Not Connected” indication, and then switch to [ASIO DirectX Full Duplex Driver]. Also set the [Outputs] in the same way, and then close the window.



Mac:

If “Not Connected” is selected in the [Audio Device] field, click on the “Not Connected” indication, and then switch to [USB Audio CODEC]. Also set the [Outputs] in the same way, and then close the window.

- 7 Select [Add Track] → [Audio] from the [Project] menu.

The Add Audio Track dialog window appears.

- 8 Set the “Count” and “Configuration” parameters, and then click [Add Track].



The added tracks will appear.

NOTE You will normally use a stereo track when recording synthesizers, and a monaural track when recording vocals or guitars.

Preparing to Record

- 1 Click in the track list (the area in which the track names are displayed) to select a track to record on.

The various settings for the selected track are available in the Inspector on the left side of the display.

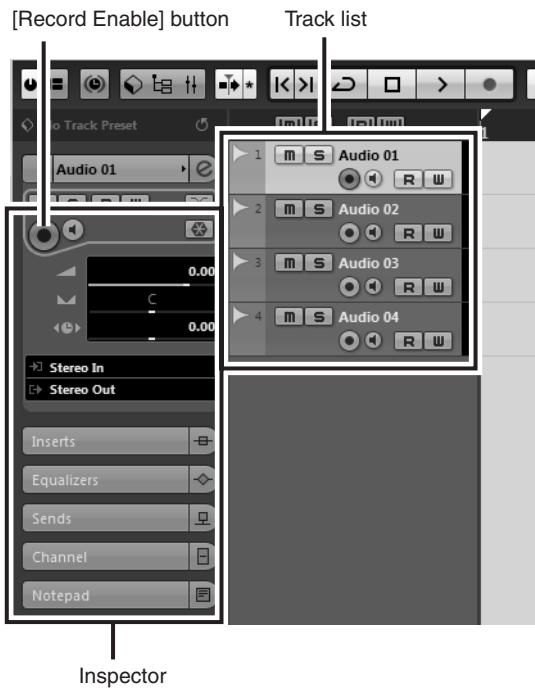

- 2 Make sure the [Record Enable] button for the track to be recorded is turned on.
If the [Record Enable] button is off, click it to turn it on.
- 3 Play the instrument to be recorded, and adjust the MW mixer's GAIN control, channel faders and REC OUT fader so that the Clipping indicator never lights.

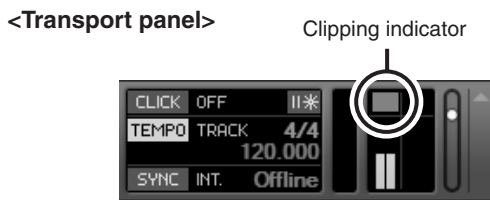

- 4 Specify the point at which you want to start recording via the ruler at the top of the window for the project.

Click the black area of the ruler to move the project cursor (the vertical black line) to that position.



Recording and Playback

- 1 Click the Transport panel [Record] button to begin recording.

When recording is started the project cursor will begin moving to the right and a box that displays the recording results will be created.

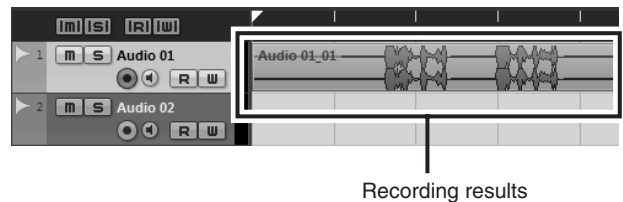
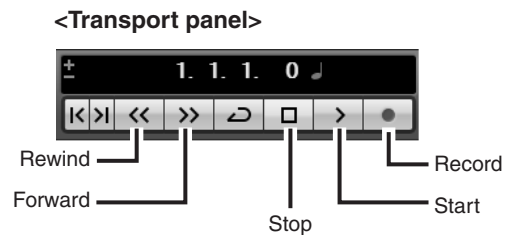

- 2 Play the part.
- 3 When you finish recording the track, click the Transport panel [Stop] button.

To hear playback of the track you have just recorded, use either the Transport panel [Rewind] button or the ruler to rewind to the beginning of the recorded section, then click the Transport panel [Start] button.

4 Select [Mixer] from the [Devices] menu to open the Mixer window.

The overall playback level will be displayed via the master section bus level meter on the right side of the mixer window, and the channel level will be displayed via the channel strip level meter.

NOTE The output signal from Cubase AI is routed to the MW mixer's 2TR IN inputs. To hear the playback sound via a pair of headphones plugged into the MW mixer, set the bus select switch to TO MONITOR () and adjust the volume with the 2TR IN/USB control and the PHONES control.

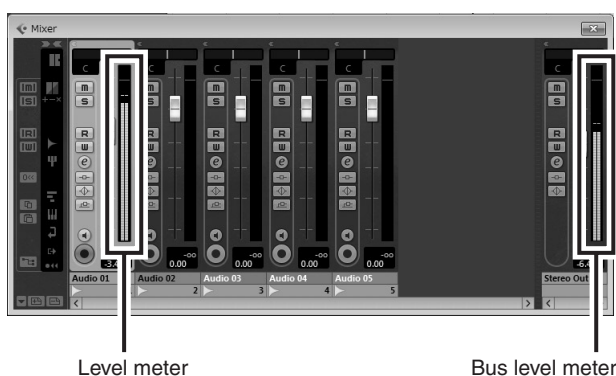

5 To save the project select [Save] from the [File] menu and enter a file name before actually saving the file.

Save your project frequently to insure against losing large amounts of data if a problem occurs.

6 Repeat steps 1 through 5 to record further material on the same track.

7 To record additional material on a different track, select a new track and repeat the record procedure.

NOTE You can monitor the sound being recorded and a previously recorded sound simultaneously while recording (MONITOR MIX). Refer to “[15](#) 2TR IN/USB” on page 19 for details.

Step 6 Mixing with Cubase AI

In this section we'll try mixing down multiple recorded audio tracks to stereo, and creating an audio file. Mixes can be stored as WAV or AIFF files, which can then be recorded to audio CDs.

- 1 Launch Cubase AI and open a project file.
- 2 Click the [Start] button on the Transport Panel.
- 3 While listening to playback, drag the channel strip level faders up and down to create the desired initial balance, then adjust the overall volume using the bus volume fader.

Start with the Featured Part

You can start working on a mix from almost any part, but it makes the most sense to start with the main instrument or vocal. Set up an initial level for the main part, and then build the rest of the mix around it.

For example, if you're mixing a piano trio with a vocalist, begin by setting the level of the vocal track at around the nominal level, and then gradually add the other instruments. Your choices will also be influenced by the type of music you are working on. If the song is a ballad you might want to add the piano to the mix after the vocal, and then add the bass and drums. If it's a more rhythmically oriented piece you could add the bass and drums first, and then the piano. Whatever best serves the music is right.

- 4** Drag the pan controls on the top of the channel strips left and right to set the stereo position of each track.



Pan Effectively

“Panning” creates the illusion of stereo space by changing the relative levels of each track’s signal sent to the left and right speakers. If a signal is sent only to the left speaker, the sound will appear to come from the far left side of the stereo sound field. If it sent with equal level to both left and right speakers our ears tell us the sound is located in the center of the stage. Judicious panning can also help to create cleaner-sounding mixes by spreading the instruments out across the sound stage so that they don’t “get in each other’s way.” There are no hard and fast rules, but the bass and kick drum are usually placed in the center of the mix, as is the lead instrument or vocal. Other instruments should be evenly balanced throughout the sound stage in a well-balanced manner.

- 5** At this point you can begin to use EQ to refine your mix, and add effects.

As an example let’s try adding reverb. Click the [Edit] button () on the left side of the channel strip to open the VST audio channel settings window. Click Inserts 1 and select “Reverb - RoomWorks SE”.

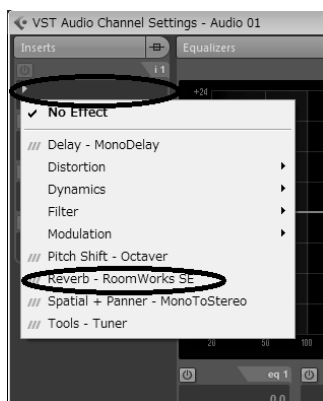

NOTE For further details refer to the pdf manual provided with the Cubase AI software.



It’s a good idea to lower the channel fader a bit before adding an effect, since the effect can cause an increase in the overall channel level.

- 6** Double-click the left locator (starting point) and right locator (ending point) of the Transport panel. Change each highlighted number, and then specify the position of the locator.



- 7** When the final mix adjustments have been made, go to the [File] menu and select [Export] → [Audio Mixdown].

- 8** Enter a file name and select a destination for the file as well as a file type.

If you intend to use the file to create an audio CD, select the WAV file type (AIFF on Mac OS X), 16 bit, and 44.1 kHz.

- 9** Click [Export].

Progress of the mixdown operation will be shown in a progress window. When the progress window closes the mixdown is complete.

NOTE Audio files created by mixdown can be directly played back using the Windows Media Player, or iTunes on a Mac computer.

Setup

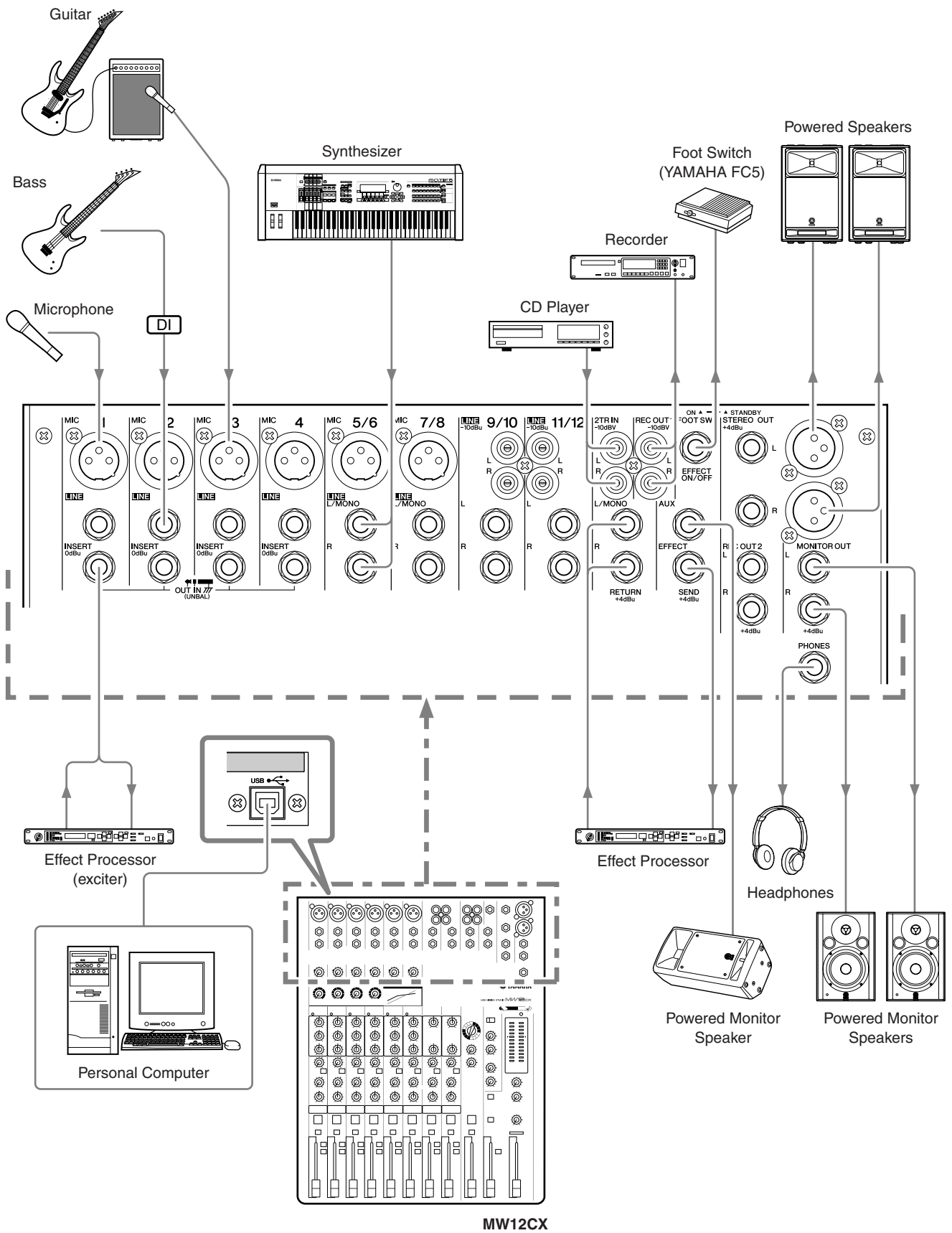

MW12CX

Front & Rear Panels

The following applies to both the MW12CX and MW12C. In cases where different features need to be described for each model, the MW12CX feature will be described first, followed by the MW12C feature in brackets: MW12CX (MW12C).

Channel Control Section

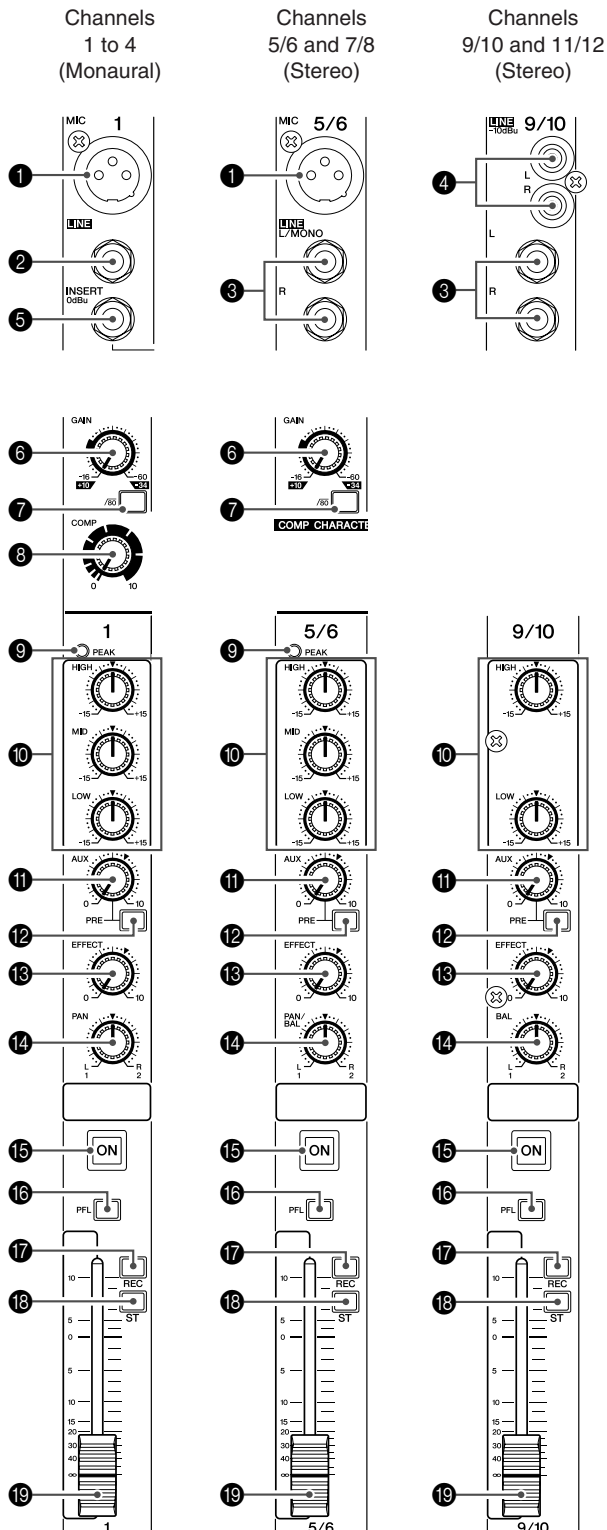

MW12CX

1 MIC Input Jacks (CHs 1 to 4, 5/6, 7/8)

These are balanced XLR-type microphone input jacks (1:Ground; 2:Hot; 3:Cold).

2 LINE Input Jacks (CHs 1 to 4)

These are balanced TRS phone-jack line inputs (T:Hot; R:Cold; S:Ground).

You can connect either balanced or unbalanced phone plugs to these jacks.

3 LINE Input Jacks (CHs 5/6 to 11/12)

These are unbalanced phone-jack stereo line inputs.

4 LINE Input Jacks (CHs 9/10, 11/12)

These are unbalanced stereo RCA pin jacks.

NOTE Where an input channel provides both a MIC input jack and a LINE input jack, or a LINE input jack and an RCA pin jack, you can use either jack but not both at the same time. Please connect to only one jack on each channel.

5 INSERT Jacks (CHs 1 to 4)

Each of these jacks provides an insert point between the equalizer and fader of the corresponding monaural input channel (CHs 1 to 4). The INSERT jacks are ideal for connecting devices such as graphic equalizers, compressors, or noise filters into the corresponding channels. These are TRS (tip, ring, sleeve) phone jacks that carry both the send and return signal (tip = send/out; ring = return/in; sleeve = ground).

NOTE Patching external devices via an INSERT jack requires a special insert cable such as illustrated below (insert cable sold separately).

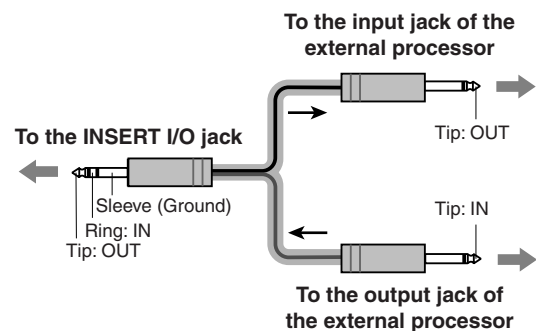

CAUTION The signal output from the INSERT jacks is reverse-phased. This should not be a problem when connecting to an effect unit, but please be aware of the possibility of phase conflict when connecting to other types of device. A reversed-phased signal may result in degraded sound quality or even complete sound cancellation.

6 GAIN Control

Adjusts the input signal level.

To achieve the best balance between S/N ratio and dynamic range, adjust the level so that the PEAK indicator **9** lights only occasionally and briefly on the highest input transients. The -60 to -16 scale is the MIC input adjustment range. The -34 to +10 scale is the LINE input adjustment range.

7 $\sqrt{80}$ Switch (High Pass Filter)

This switch toggles the HPF on or off. To turn the HPF on, press the switch in (■). The HPF cuts frequencies below 80 Hz (the HPF does not apply to the line inputs of stereo input channels **3**).

8 COMP Control

Adjusts the amount of compression applied to the channel. As the knob is turned to the right the compression ratio increases while the output gain is automatically adjusted accordingly. The result is smoother, more even dynamics because louder signals are attenuated while the overall level is boosted.

NOTE Avoid setting the compression too high, as the higher average output level that results may lead to feedback.

9 PEAK Indicator

The peak level of the post-EQ signal is detected, and the PEAK indicator lights red when the level reaches 3 dB below clipping. For XLR-equipped stereo input channels (5/6 and 7/8), both the post-EQ and post-mic-amp peak levels are detected, and the indicator lights red if either of these levels reaches 3 dB below clipping.

10 Equalizer (HIGH, MID, and LOW)

This three-band equalizer adjusts the channel's high, mid, and low frequency bands. Channels 9/10 and 11/12 have two bands: high and low. Setting the knob to the ▼ position produces a flat response in the corresponding band. Turning the knob to the right boosts the corresponding frequency band, while turning to the left attenuates the band. The following table shows the EQ type, frequency, and maximum cut/boost for each of the three bands.

Band	Type	Frequency	Maximum Cut/Boost
HIGH	Shelving	10 kHz	±15 dB
MID	Peaking	2.5 kHz	
LOW	Shelving	100 Hz	

11 AUX (AUX1) Control

Adjusts the level of the signal sent from the channel to the AUX (AUX1) bus. The knob should generally be set close to the ▼ position.

On stereo channels, the signals from the L (odd) and R (even) channels are mixed and sent to the AUX (AUX1) bus.

NOTE To send the signal to the buses set the ON switch to on (■).

12 AUX PRE Switch

Selects whether the pre-fader or the post-fader signal is fed to the AUX (AUX1) bus. If the switch is on (■), the mixer sends the pre-fader signal (the signal immediately prior to the Channel fader **19**) to the AUX (AUX1) bus, so that AUX (AUX1) output is not affected by the fader. If the switch is off (■) the mixer sends the post-fader signal to the AUX (AUX1) bus.

13 EFFECT (AUX2) Controls

Adjusts the level of the signal sent from the channel to the EFFECT (AUX2) bus. Note that the signal level sent to the bus is also affected by the Channel fader **19**. On stereo channels (5/6, 7/8, 9/10, or 11/12), the signals from the L (odd) and R (even) channels are mixed and then sent to the EFFECT (AUX2) bus.

**14 PAN Control (1 to 4)
PAN/BAL Control (5/6 and 7/8)
BAL Control (9/10 and 11/12)**

The PAN control determines the stereo positioning of the channel signal on the REC L and R buses or on the Stereo L and R buses.

The BAL control knob sets the balance between left and right channels. Signals input to the L input (odd channel) go to the REC L bus or to the Stereo L bus; signals input to the R input (even channel) go to the REC R bus or the Stereo R bus.

NOTE On channels where this knob provides both PAN and BAL control (channels 5/6 and 7/8), the knob operates as a PAN control when input is received via the MIC jack or L (MONO) input only, and as a BAL control when input is received via both L and R inputs.

15 ON Switch

Turn this switch on to send the signal to the buses. The switch lights orange when on.

16 PFL (Pre-Fader Listen) Switch

This switch lets you monitor the channel's pre-fader signal. Press the switch in (■) so that it lights to turn it on. When the switch is on the channel pre-fader **19** signal is output to the PHONES and MONITOR OUT jacks for monitoring.

17 REC Switch

This switch assigns the channel's signal to the REC L and R buses.

NOTE To send the signal to the REC bus engage the ON switch (■).

18 ST Switch

This switch assigns the channel's signal to the Stereo L and R buses.

NOTE To send the signal to the Stereo bus engage the ON switch (■).

19 Channel Fader

Adjusts the level of the channel signal. Use these faders to adjust the balance between the various channels.

NOTE Set the fader sliders for unused channels all the way down to minimize noise.

Master Control Section

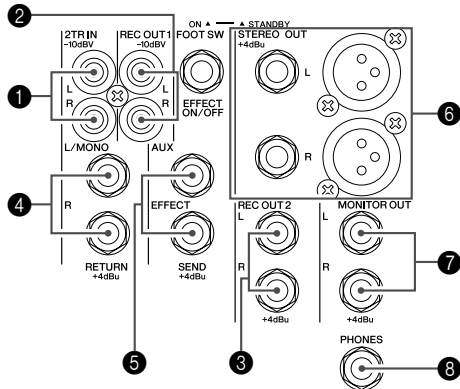

YAMAHA

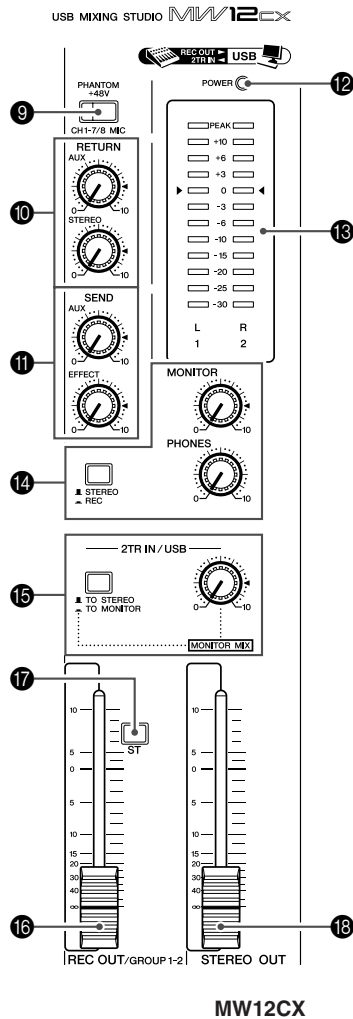

MW12CX

* impedance balanced

Since the hot and cold terminals of impedance balanced output jacks have the same impedance, these output jacks are less affected by induced noise.

1 2TR IN Jacks

These RCA pin jacks can be used to input a stereo sound source. Use these jacks when you want to connect a CD player directly to the mixer.

NOTE

- Select where you want to send the signal using the 2TR IN/USB switch **15**, and adjust the signal level using the 2TR IN/USB control in the Master Control section.

- A signals input via both the 2TR IN input and the USB input are mixed.

2 REC OUT 1 (L, R) Jacks

These are RCA pin jacks that can be used to connect to an external stereo recorder. The signal processed by the REC OUT fader is output via these jacks.

3 REC OUT 2 (L, R) Jacks

These are impedance-balanced TRS phone jacks that can be used to connect to an external stereo recorder. The signal processed by the REC OUT fader is output via these jacks.

4 RETURN L (MONO), R Jacks

These are unbalanced phone-jack type line inputs. The signal received by these jacks is sent to the STEREO L/R bus and the AUX (AUX1) bus. These jacks are typically used to receive the signal returned from an external effect device (reverb, delay, etc.).

NOTE These jacks can also be used as an auxiliary stereo input. If you connect to the L (MONO) jack only, the mixer will recognize the signal as monaural and will send the identical signal to both the L and R jacks.

5 SEND Jacks

• AUX (AUX1)

This is an impedance balanced* TRS phone jack that outputs the signals from AUX (AUX1) bus. You can use this jack, for example, to connect to an effect unit, cue box, or other monitoring system.

• EFFECT (AUX2)

This is an impedance balanced* TRS phone jack that outputs the signal from the EFFECT (AUX2) bus. You can use this jack, for example, to connect to an external effect unit.

6 STEREO OUT (L, R) Jacks

These jacks deliver the mixer's stereo output. You can use these jacks, for example, to connect to the power amplifier driving your main speakers. You can also connect these jacks to a recording device when you wish to record mixer's stereo output while using the STEREO OUT Master fader **18** for level control.

• XLR jacks

XLR-type balanced output jacks.

• LINE jacks

TRS phone-jack type balanced outputs.

7 MONITOR OUT Jacks

Connect these impedance-balanced* TRS phone jacks to your monitor system.

NOTE The signal output by these jacks is determined by the MONITOR switch **14**, the 2TR IN/USB **15**, and the PFL switches on the input channels.

8 PHONES Jack

Connect a pair of headphones to this TRS phone jack. The PHONES jack outputs the same signal as the MONITOR OUT jacks.

9 PHANTOM +48 V Switch

This switch toggles phantom power on and off. When the switch is on the mixer supplies +48V phantom power to all channels that have XLR mic input jacks (CHs 1–4, 5/6, 7/8). Turn this switch on when using one or more phantom-powered condenser microphones.

NOTE When this switch is on the mixer supplies DC +48 V power to pins 2 and 3 of all XLR-type MIC INPUT jacks.



- Be sure to leave this switch off (OFF) if you do not need phantom power.
- When turning the switch on (ON), be sure that only condenser mics are connected to the XLR input jacks (CHs: 1 to 7/8). Devices other than condenser mics may be damaged if connected to the phantom power supply. Note, however, that the switch may be left on when connecting to balanced dynamic microphones.
- To avoid damage to speakers, be sure to turn off amplifiers (or powered speakers) before turning this switch on or off. We also recommend that you turn all output controls (STEREO OUT Master Fader, REC OUT Fader, etc.) to their minimum settings before operating the switch to avoid the risk of loud noises that could cause hearing loss or device damage.

10 RETURN**• AUX (AUX1) Control**

Adjusts the level at which the L/R signal received at the RETURN jacks (L (MONO) and R) is sent to the AUX (AUX2) bus.

• STEREO Control

Adjusts the level at which the signal received at the RETURN jacks (L (MONO) and R) is sent to the STEREO L/R bus.

NOTE If you supply a signal to the RETURN L (MONO) jack only, the mixer sends the same signal to both the L and R Stereo buses.

11 Master SEND**• Master AUX (AUX1) Control**

Adjusts the signal level sent to the AUX (AUX1) SEND jack.

• Master EFFECT (AUX2) Control

Adjusts the level of the signal sent to the EFFECT (AUX2) bus.

NOTE If you are using the MW12CX, the Master EFFECT control does not affect the level of the signal sent from the EFFECT bus to the internal digital effect processor.

12 POWER Indicator

This indicator lights when the mixer's power is ON.

13 Level Meter

This LED meter displays the level of the signal selected by the MONITOR switch 14, 2TR IN/USB switch 15 and PFL switch. The "0" segment corresponds to the nominal output level. The PEAK segment lights red when the output reaches the clipping level.

14 MONITOR/PHONES**• MONITOR Switch**

If this switch is set to REC (OFF), the REC L/R bus signals are sent to the MONITOR OUT jacks, the PHONES jack, and the level meter. If it is set to STEREO (ON), the STEREO L/R bus signals are sent to these jacks and the level meter.

• MONITOR Control

Controls the level of the signal output to the MONITOR OUT jacks.

• PHONES Control

Controls the level of the signal output to the PHONES jack.

15 2TR IN/USB**• 2TR IN/USB Switch**

If this switch is set to TO MONITOR (ON), the signals input via the 2TR IN jacks and the USB connector are sent to the MONITOR OUT jacks, the PHONES jack, and the level meter. If it is set to TO STEREO (OFF), the signals are sent to the STEREO L/R bus.

• 2TR IN/USB control

Adjusts the level of the signal sent from the 2TR IN jacks and the USB connector to the STEREO L/R bus.

The following illustration shows how the switch settings correspond to the signal selection.

Switches			Signals output via the MONITOR/PHONES jacks
PFL	MONITOR/PHONES	2TR IN/USB	
ON (ON)	—	—	PFL
OFF (OFF)	STEREO (ON)	TO STEREO (OFF)	STEREO (+ 2TR IN/USB)
		TO MONITOR (ON)	STEREO + 2TR IN/USB MONITOR MIX *
	REC (OFF)	TO STEREO (OFF)	REC
		TO MONITOR (ON)	REC (+ 2TR IN/USB)

* **MONITOR MIX**: When overdubbing, you can adjust the levels of the monitor playback signal and the signal being recorded separately. For MONITOR MIX turn on the REC and ST switches of the corresponding channels.

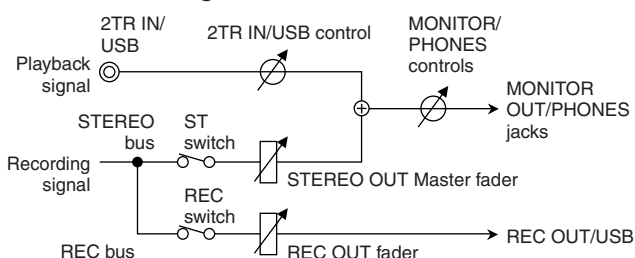
MONITOR MIX Signal Flow

NOTE If the input channel PFL switch is on (ON), then only the PFL output from that channel is sent to the C-R OUT jacks, PHONES jacks, and level meter.

16 REC OUT Fader

Adjusts the signal level sent to the REC OUT jacks and the USB connector.

17 ST Switch

If this switch is on (ON), the signals are sent to the STEREO L/R bus via the REC OUT fader 16. The REC L signal goes to Stereo L and the REC R signal goes to Stereo R.

18 STEREO OUT Master Fader

Adjusts the signal level sent to the STEREO OUT jacks.

Digital Effect

* Only the MW12CX has digital effects.

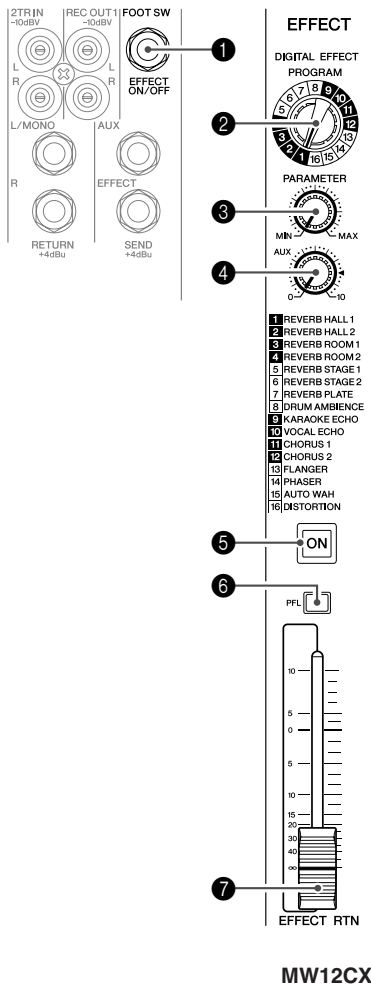

1 FOOT SWITCH Jack

A Yamaha FC5 foot switch (sold separately) can be connected to this jack and used to toggle the digital effects ON and OFF.

2 PROGRAM Dial

Selects one of the 16 internal effects. See page 21 for details about the internal effects.

3 PARAMETER Control

Adjusts the parameter (depth, speed, etc.) for the selected effect. The last value used with each effect type is saved.

NOTE When you change to a different effect type, the mixer automatically restores the value that was previously used with the newly selected effect (regardless of the current position of the PARAMETER Control knob). These parameter values are reset when the power is turned off.

4 AUX Control

Adjusts the level of the signal sent from the internal digital effect unit to the AUX bus.

NOTE The EFFECT RTN fader does not affect the level of the signal sent to the AUX bus.

5 ON Switch

Switches the internal effect on or off. The internal effect is applied only if this switch is turned on. The switch lights orange when on.

An optional Yamaha FC5 foot switch (sold separately) can be used to toggle the digital effects ON and OFF.

NOTE The ON switch lights and the internal effect unit is active by default when the power is initially turned on.

6 PFL Switch

Turn this switch on to send the effect signal to the PFL bus.

7 EFFECT RTN Fader

Adjusts the signal level sent from the internal digital effect unit to the STEREO bus.

Rear Input/Output Section

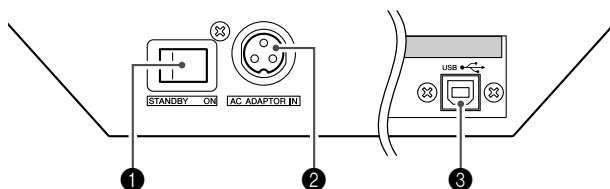

1 POWER Switch

Use this switch to turn the mixer's power ON or to STANDBY mode.



Note that a small current continues to flow while the switch is in the STANDBY position. If you do not plan to use the mixer for a while, be sure to unplug the AC adaptor from the wall outlet.

2 AC ADAPTOR IN Connector

Connect the supplied power adaptor to this connector (see page 6).

3 USB Connector

Connects to the computer via the included cable. The USB connector outputs the same signal as the REC OUT jacks.





When connecting or disconnecting the USB cable be sure to turn the 2TR IN/USB control all the way down.

Digital Effect Program List

No	Program	Parameter	Description
1	REVERB HALL 1	REVERB TIME	Reverb simulating a large space such as a concert hall.
2	REVERB HALL 2	REVERB TIME	
3	REVERB ROOM 1	REVERB TIME	Reverb simulating the acoustics of a small space (room).
4	REVERB ROOM 2	REVERB TIME	
5	REVERB STAGE 1	REVERB TIME	Reverb simulating a large stage.
6	REVERB STAGE 2	REVERB TIME	
7	REVERB PLATE	REVERB TIME	Simulation of a metal-plate reverb unit, producing a more hard-edged sound.
8	DRUM AMBIENCE	REVERB TIME	A short reverb that is ideal for use with kick drum.
9	KARAOKE ECHO	DELAY TIME	Echo designed for karaoke (sing-along) applications.
10	VOCAL ECHO	DELAY TIME	Echo suitable for vocals.
11	CHORUS 1	LFO Frequency	Creates a thick sound by modulating the delay time. The PARAMETER control adjusts the frequency of the LFO* that modulates the delay time.
12	CHORUS 2	LFO Frequency	
13	FLANGER	LFO Frequency	A sweeping pitched effect. The PARAMETER control adjusts the frequency of the LFO* that modulates the delay time.
14	PHASER	LFO Frequency	Phase modulation produces a cyclical phasing effect. The PARAMETER control adjusts the frequency of the LFO* that modulates the delay time.
15	AUTO WAH	LFO Frequency	A wah-wah effect with cyclical filter modulation. The PARAMETER control adjusts the frequency of the LFO* that modulates the delay time.
16	DISTORTION	DRIVE	Adds a sharp-edged distortion to the sound.

* "LFO" stands for Low Frequency Oscillator. An LFO is normally used to modulate another signal, determining the modulation speed and waveform shape.

Jack List

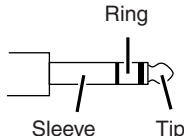
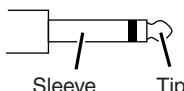
Input and Output Jacks	Polarities	Configurations
MIC INPUT, STEREO OUT	Pin 1: Ground Pin 2: Hot (+) Pin 3: Cold (-)	<div style="display: flex; justify-content: space-around;"> <div style="text-align: center;"> <p>INPUT</p>  </div> <div style="text-align: center;"> <p>OUTPUT</p>  </div> </div> <p style="text-align: right;">XLR Connector</p>
LINE INPUT (CH1 to 4) REC OUT, STEREO OUT, MONITOR OUT, AUX (AUX1), EFFECT (AUX2)*	Tip: Hot (+) Ring: Cold (-) Sleeve: Ground	 <p style="text-align: right;">TRS Phone Connector</p>
INSERT	Tip: Output Ring: Input Sleeve: Ground	
PHONES	Tip: L Ring: R Sleeve: Ground	 <p style="text-align: right;">Phone Connector</p>
RETURN LINE INPUT (CH5/6 to 11/12)	Tip: Hot Sleeve: Ground	

* These jacks will also accept connection to monaural phone Connectors. If you use monaural phone connectors, the connection will be unbalanced.

Troubleshooting

<p>The MW mixer won't turn on.</p>	<ul style="list-style-type: none"> <input type="checkbox"/> Is the included adaptor properly plugged into both the mixer and an appropriate AC wall outlet?
<p>The system doesn't work properly.</p>	<ul style="list-style-type: none"> <input type="checkbox"/> Are the USB cable and all necessary audio cables properly connected? <input type="checkbox"/> Are you using a USB hub? USB hubs can interfere with proper operation, so try connecting the MW mixer directly to a USB port on the computer. If the computer has multiple USB ports, try a different USB port. <input type="checkbox"/> Are you using other USB devices at the same time? If so, try removing the other device(s) and connecting only the Yamaha USB device.
<p>The Input ports are not shown (Windows 7/Vista).</p>	<ul style="list-style-type: none"> <input type="checkbox"/> Is the sound input of your computer operating system assigned properly? <ol style="list-style-type: none"> 1. From the [START] menu click [Control Panel], then double-click the "Sound" icon to open the "Sound" dialog window. 2. Click the "Recording" tab, right-click the "USB Audio CODEC" icon and select "Properties." 3. Click the "Advanced" tab, then select "2 channel, 16 bit, 44100 Hz (CD Quality)" or "2 channel, 16 bit, 48000 Hz (DVD Quality)" in the "Default Format" field.
<p>No sound.</p>	<ul style="list-style-type: none"> <input type="checkbox"/> Are your speaker cables connected properly, or are they shorted? <input type="checkbox"/> Are the ON switch, ST switch, and REC switch for the channels you are using turned on? <input type="checkbox"/> Are the volume controls of your sources, audio devices, applications software, computer operating system, etc., set at appropriate levels? <input type="checkbox"/> Is the output of your computer operating system muted? <input type="checkbox"/> Do you have several applications running at the same time? Be sure to quit all applications you are not using. <input type="checkbox"/> Is the sound output of your computer operating system assigned properly? <p>Windows 7/Vista:</p> <ol style="list-style-type: none"> 1. From the [START] menu click [Control Panel], then double-click the "Sound" icon to open the "Sound" dialog window. 2. Click the "Playback" tab and check whether the "USB Audio CODEC" icon is checked. If not, right-click the "USB Audio CODEC" icon and select "Set as Default Device." 3. Click the [Recording] tab and check whether the "USB Audio CODEC" icon is checked. If not, right-click the "USB Audio CODEC" icon and select "Set as Default Device." <p>Windows XP:</p> <ol style="list-style-type: none"> 1. From the [START] menu click [Control Panel], then double-click the "Sounds and Audio Devices" icon to open the "Sounds and Audio Devices Properties" dialog window. 2. Click the "Audio" tab. 3. Set "Sound playback: Default device" and "Sound recording: Default device" to "USB Audio CODEC." 4. Click [OK]. <p>Mac:</p> <ol style="list-style-type: none"> 1. Select "System Preferences ..." from the Apple menu and then select "Sound" to open the "Sound" dialog window. 2. Click the "Input" tab and under "Choose a device for sound input" select "USB Audio CODEC". 3. Click the "Output" tab and under "Choose a device for sound output" select "USB Audio CODEC". <ul style="list-style-type: none"> <input type="checkbox"/> Is the sound output of the Cubase AI application assigned properly? For setup details refer to page 7 of the Quick Guide.

<p>The recorded sound is too low in level.</p>	<p><input type="checkbox"/> Is the computer's output level setting too low? We recommend that you set the computer output to the maximum level and mute the computer's internal speaker.</p> <p>Windows 7/Vista:</p> <ol style="list-style-type: none"> 1. From the [START] menu click [Control Panel], then double-click the "Sound" icon to open the "Sound" dialog window. 2. Click the "Playback" tab, right-click the "USB Audio CODEC" icon and select "Properties". 3. Click the "Levels" tab, then set the volume slider to its maximum level. Close the "Properties" dialog window. 4. Click the "Sounds" tab in the "Sound" dialog window, then select "No sounds" in the "Sound Scheme." <p>Windows XP:</p> <ol style="list-style-type: none"> 1. From the [START] menu click [Control Panel], then double-click the "Sounds and Audio Devices" icon to open the "Sounds and Audio Devices Properties" dialog window. 2. Click the "Volume" tab. 3. Set "Device volume" to "High." 4. Click the "Sound" tab. 5. Select "No sound" in the "Sound scheme." <p>Mac:</p> <ol style="list-style-type: none"> 1. Select [System Preferences ...] from the Apple menu and then select "Sound" to open the "Sound" dialog window. 2. Click the "Output" tab and set the volume slider at the bottom of the window to its maximum level. 3. Click the "Sound Effect" tab and set the volume slider of the "Alert volume" slider to its minimum level. <p><input type="checkbox"/> Have you connected or disconnected the USB cable while Cubase AI is running? Doing so can sometimes cause the Windows output level to be reset to its default level. Check and raise the output level if necessary.</p>
<p>The level meter doesn't show the output signal level.</p>	<p><input type="checkbox"/> Are the PFL switches for the channels you are not using turned on?</p>

<p>The sound is intermittent or distorted.</p>	<ul style="list-style-type: none"> <input type="checkbox"/> Is the PEAK indicator flashing red? You might have to lower GAIN control or channel fader levels to avoid distortion. <input type="checkbox"/> Are you applying the effects and compressor at an appropriate level? You might have to lower EFFECT RTN fader, EFFECT control and COMP control levels. <input type="checkbox"/> Are any other applications, device drivers, or USB devices (scanners, printers, etc.) running at the same time? Be sure to quit all applications you are not using. <input type="checkbox"/> Are you playing back a large number of audio tracks? The number of tracks you can play at the same time will depend on the performance of the computer you are using. You may experience intermittent playback if you exceed your computer's capabilities. <input type="checkbox"/> Are you recording or playing long continuous sections of audio? The audio data processing capabilities of your computer will depend on a number of factors including CPU speed and access to external devices. <p>On Windows XP computers, changing some settings as outlined below can improve performance.</p> <ol style="list-style-type: none"> 1. Click [Control Panel] from the [START] menu, and double-click the "Sounds and Audio Devices" icon to open the "Sounds and Audio Devices Properties" dialog window. 2. Click the "Volume" tab and click "Advanced" in "Speaker settings." The "Advanced Audio Properties" dialog window will open. 3. Click the "Performance" tab. Set "Hardware acceleration" to "Full", and "Sample rate conversion quality" to "Good." <p>Don't change these settings if you are not familiar with your computer's operating system. Check that the file system is set properly, and make sure that you have a plenty of free memory (more than 128 megabytes). If the audio files you are recording or playing are not too large, changing the virtual memory settings can sometimes improve audio performance.</p> <p>In some cases it might be necessary to update your hard disk controller, device drivers, or BIOS. Refer to your computer's support center or support page on the web for more information.</p> <ul style="list-style-type: none"> <input type="checkbox"/> Try adding memory. Adding more RAM memory can significantly increase your computer's audio performance. Refer to your computer's owner's manual for information on installing and setting up extra memory.
<p>There is a delay when playing a software synthesizer via a MIDI keyboard (latency).</p>	<ul style="list-style-type: none"> <input type="checkbox"/> Check the URL listed below for the latest information. <http://www.yamahasynth.com/>

Specifications

■ Electrical Specifications

			MIN	TYP	MAX	UNIT
Frequency Response	STEREO OUT	GAIN: min (CHs 1–7/8) 20 Hz–20 kHz Nominal output level @ 1 kHz Input: CHs 1 to 11/12, RETURN, 2TR IN	-3.0	0.0	1.0	dB
	REC OUT2					
	EFFECT/AUX (AUX1, 2*) SEND					
	MONITOR OUT, REC OUT1					
Total Harmonic Distortion (THD + N)	STEREO OUT	+14 dBu @ 20 Hz–20 kHz, Input GAIN Control at minimum			0.1	%
Hum & Noise	CH INPUT 1–4 MIC	EIN (Equivalent Input Noise): $R_s = 150 \Omega$, GAIN: maximum STEREO OUT, REC OUT fader at nominal level and all channels' ST and REC switches off. Master EFFECT/AUX (AUX1, 2) control at nominal level and all CH EFFECT/AUX (AUX1, 2) controls at minimum. STEREO OUT, REC OUT fader and one CH fader at nominal level. Residual Output Noise				-128
	STEREO OUT					-88
	REC OUT2					-81
	EFFECT/AUX (AUX1, 2*) SEND					-64
	STEREO OUT					-98
Crosstalk (1 kHz)	Adjacent Input	CHs 1–4				-70
	Input to Output	STEREO L/R, CHs 1–4, PAN: panned hard left or right				-70
Maximum voltage gain (1 kHz)	$R_s = 150 \Omega$ INPUT GAIN: maximum	MIC to CH INSERT OUT		60		
		MIC to STEREO OUT		84		
		MIC to REC OUT2		94		
		MIC to REC to ST		72.2		
		MIC to REC OUT1		84		
		MIC to MONITOR OUT, ST TO MONITOR		83		
		MIC to PHONES OUT		76		
		MIC to AUX (AUX1*) SEND PRE		86		
		MIC to AUX (AUX1*) SEND POST, EFFECT (AUX2*) SEND		58		
		CH 5/6, 7/8 LINE to STEREO OUT		47		
		CH 5/6, 7/8 LINE to REC OUT2		57		
		CH 5/6, 7/8 AUX (AUX1*) SEND PRE		34		
		CH 5/6, 7/8 LINE to AUX (AUX1*) SEND POST, EFFECT (AUX2*) SEND		16		
		CH 9/10, 11/12 to STEREO OUT		9		
		CH 9/10, 11/12 to REC OUT2		27.8		
	$R_s = 150 \Omega$	RETURN to STEREO OUT				
		RETURN to EFFECT (AUX2*) SEND				
	$R_s = 600 \Omega$	2TR IN to STEREO OUT				
Phantom Voltage	MIC	no load		48		V

■ General Specifications

USB Audio		Input/Output: 44.1/48 kHz
Input HPF		CHs 1–7/8, 80 Hz, 12 dB/oct
Input equalization	CHs 1–7/8	HIGH: 10 kHz (shelving) MID: 2.5 kHz (peaking) LOW: 100 Hz (shelving)
	CH 9/10–11/12	HIGH: 10 kHz (shelving) LOW: 100 Hz (shelving)
PEAK Indicator		Red LED turns on when post EQ signal (either post MIC HA or post EQ signal for CHs 5/6, 7/8) reaches -3 dB below clipping (+17 dBu).
Internal Digital Effect (Only MW12CX)		16 PROGRAM, PARAMETER control Foot Switch (Digital Effect On/Off)
LED Level Meter	Pre MONITOR Level	2x12 points LED meter (PEAK, +10, +6, +3, 0, -3, -6, -10, -15, -20, -25, -30 dB) PEAK lights if the signal level reaches 3 dB below the clipping level.
Power Supply Adaptor	PA-20	AC 35 VCT, 0.94 A, Cable Length = 3.6 m
Power Consumption		30 W
Dimensions (W x H x D)		346.2 mm x 86.1 mm x 436.6 mm
Net Weight		3.2 kg (MW12CX), 3 kg (MW12C)

All faders are nominal if not specified.
Output impedance of signal generator: 150 ohms

* The MW12CX feature is described first, followed by the MW12C feature in brackets: MW12CX (MW12C)

■ Analog Input Specifications

Input Connectors	Gain	Input Impedance	Appropriate Impedance	Sensitivity *	Nominal Level	Max. before Clipping	Connector Specifications
CH INPUT MIC (CHs 1–4)	-60 dB	3k Ω	50–600 Ω Mics	-80 dBu (0.078 mV)	-60 dBu (0.775 mV)	-40 dBu (7.75 mV)	XLR-3-31 type (balanced [1 = GND, 2 = HOT, 3 = COLD])
	-16 dB			-36 dBu (12.3 mV)	-16 dBu (123 mV)	+4 dBu (1.23 V)	
CH INPUT LINE (CHs 1–4)	-34 dB	10k Ω	600 Ω Lines	-54 dBu (1.55 mV)	-34 dBu (15.5 mV)	-14 dBu (155 mV)	TRS phone jack (balanced [Tip = HOT, Ring = COLD, Sleeve = GND])
	+10 dB			-10 dBu (245 mV)	+10 dBu (2.45 V)	+30 dBu (24.5 V)	
ST CH MIC INPUT (CHs 5/6, 7/8)	-60 dB	3k Ω	50–600 Ω Mics	-80 dBu (0.078 mV)	-60 dBu (0.775 mV)	-40 dBu (7.75 mV)	XLR-3-31 type (balanced [1 = GND, 2 = HOT, 3 = COLD])
	-16 dB			-36 dBu (12.3 mV)	-16 dBu (123 mV)	-6 dBu (389 mV)	
ST CH LINE INPUT (CHs 5/6, 7/8)	-34 dB	10k Ω	600 Ω Lines	-54 dBu (1.55 mV)	-34 dBu (15.5 mV)	-14 dBu (155 mV)	Phone jack (unbalanced)
	+10 dB			-10 dBu (245 mV)	+10 dBu (2.45 V)	+30 dBu (24.5 V)	
ST CH INPUT (CHs 9/10, 11/12)	—	10k Ω	600 Ω Lines	-30 dBu (24.5 mV)	-10 dBu (245 mV)	+10 dBu (2.45 V)	Phone jack (unbalanced) RCA pin jack
CH INSERT IN (CHs 1–4)	—	10k Ω	600 Ω Lines	-20 dBu (77.5 mV)	0 dBu (0.775 V)	+20 dBu (7.75 V)	TRS phone Jack (unbalanced [Tip = Out, Ring = In, Sleeve = GND])
RETURN (L, R)	—	10k Ω	600 Ω Lines	-12 dBu (195 mV)	+4 dBu (1.23 V)	+24 dBu (12.3 V)	Phone jack (unbalanced)
2TR IN (L, R)	—	10k Ω	600 Ω Lines	-26 dBV (50.1 mV)	-10dBV (0.316V)	+10dBV (3.16 V)	RCA pin jack

Where 0 dBu = 0.775 Vrms and 0 dBV = 1 Vrms

* Sensitivity : The lowest level that will produce an output of +4 dB (1.23 V), or the nominal output level when the unit is set to the maximum level. (All faders and level controls are at their maximum position.)

■ Analog Output Specifications

Output Connectors	Output Impedance	Appropriate Impedance	Nominal Level	Max. before clipping	Connector Specifications
STEREO OUT (L, R)	75 Ω	600 Ω Lines	+4dBu (1.23 V)	+24 dBu (12.3 V)	XLR-3-32 type (balanced [1 = GND, 2 = HOT, 3 = COLD]) TRS phone jack (balanced [Tip = HOT, Ring = COLD, Sleeve = GND])
REC OUT2 (L, R)	150 Ω	10k Ω Lines	+4dBu (1.23 V)	+20 dBu (7.75 V)	TRS phone jack (impedance balanced [Tip = HOT, Ring = COLD, Sleeve = GND])
EFFECT/AUX (AUX1, 2*) SEND	150 Ω	10k Ω Lines	+4dBu (1.23 V)	+20 dBu (7.75 V)	TRS phone jack (impedance balanced [Tip = HOT, Ring = COLD, Sleeve = GND])
CH INSERT OUT (CHs 1–4)	75 Ω	10k Ω Lines	0 dBu (0.775 V)	+20 dBu (7.75 V)	TRS phone jack (unbalanced [Tip = Out, Ring = In, Sleeve = GND])
REC OUT1 (L, R)	600 Ω	10k Ω Lines	-10 dBV (0.316 V)	+10 dBV (3.16 V)	RCA pin jack
MONITOR OUT (L, R)	150 Ω	10k Ω Lines	+4 dBu (1.23 V)	+20 dBu (7.75 V)	TRS phone jack (impedance balanced [Tip = HOT, Ring = COLD, Sleeve = GND])
PHONES OUT	100 Ω	40 Ω Phones	3 mW	75 mW	TRS phone jack

Where 0 dBu = 0.775 Vrms and 0 dBV = 1 Vrms

* The MW12CX feature is described first, followed by the MW12C feature in brackets: MW12CX (MW12C)

■ Digital Input/Output Specifications

Connector	Format	Data Length	Connector Specification
USB	USB Audio 1.1	16 bit	USB B type

■ Dimensional Diagrams

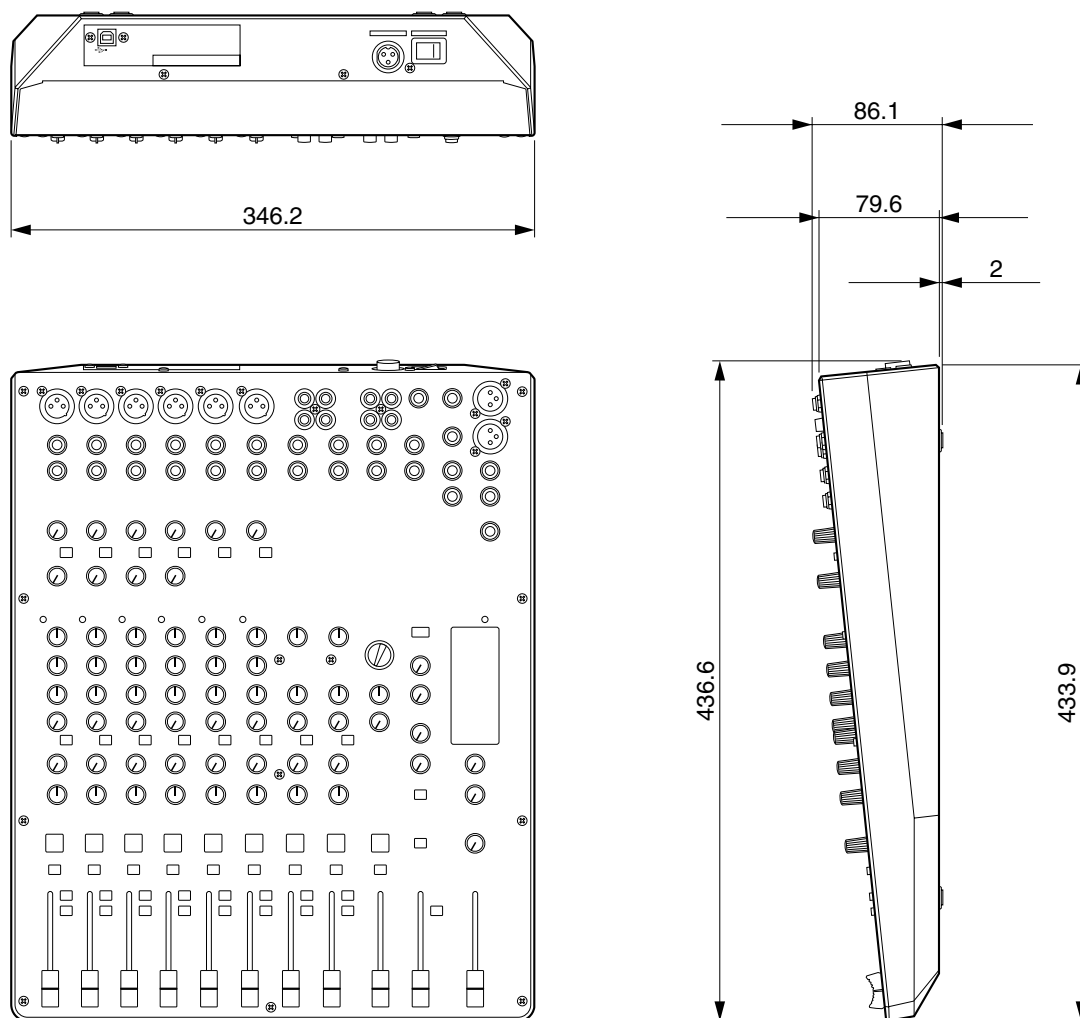

MW12CX

Unit: mm

* Specifications and descriptions in this owner's manual are for information purposes only. Yamaha Corp. reserves the right to change or modify products or specifications at any time without prior notice. Since specifications, equipment or options may not be the same in every locale, please check with your Yamaha dealer.

■ Block Diagram and Level Diagram

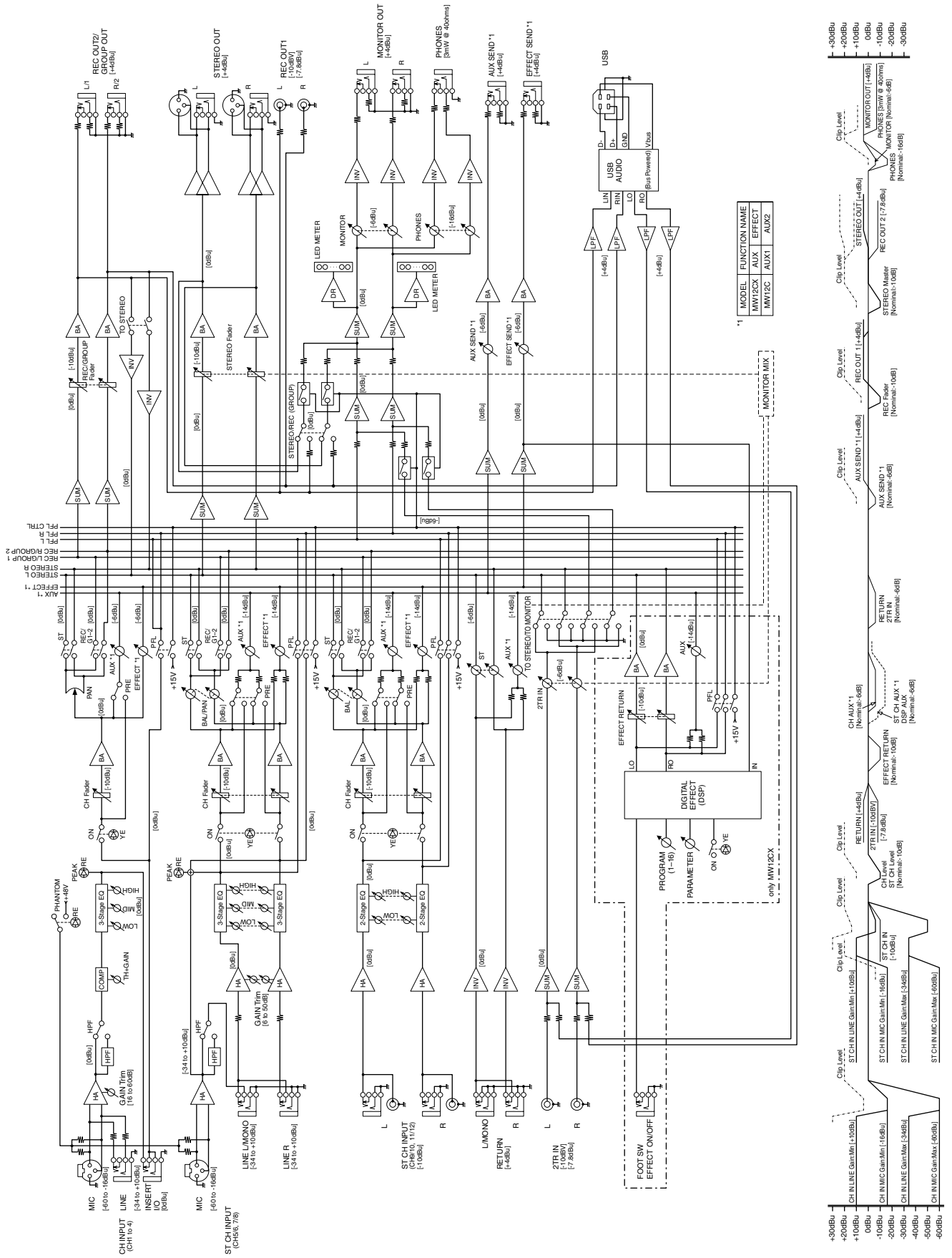

About the accessory disk

SPECIAL NOTICE

- The software included in the accessory disk and the copyrights thereof are under exclusive ownership by Steinberg Media Technologies GmbH.
- Copying of the software or reproduction of this manual in whole or in part by any means is expressly forbidden without the written consent of the manufacturer.
- Yamaha makes no representations or warranties with regard to the use of the software and documentation and cannot be held responsible for the results of the use of this manual and the software.
- This disk is NOT for audio/visual purpose. Do not attempt to play the disk on an audio/visual CD/DVD player. Doing so may result in irreparable damage to your player.
- Note that Yamaha does not offer technical support for the DAW software in the accessory disk.

About the DAW software in the accessory disk

The accessory disk contains DAW software both for Windows and Mac.

- NOTE**
- Make sure to install DAW software under the “Administrator” account.
 - In order to have continuous use of the DAW software in the accessory disk, including support and other benefits, you will need to register the software and activate your software license by starting the software while the computer is connected to the Internet. Click the “Register Now” button shown when the software is started, then fill in all required fields for registration. If you do not register the software, you will be unable to use it after a limited period of time expires.
 - To install on Mac computers double-click the “Cubase AI*.mpkg” icon or the “Cubase AI* Start Center” icon. “*” indicates where the version number appears in the actual icon name.

For information about the minimum system requirements and latest information on the software in the disk, check the web site below.

<<http://www.yamahasynth.com/>>

About software support

Support for the DAW software in the accessory disk is provided by Steinberg on its website at the following address. <http://www.steinberg.net>

You can visit the Steinberg site also via the Help menu of the included DAW software. (The Help menu also includes the PDF manual and other information on the software.)

Über die Zubehör-Disc

BESONDERER HINWEIS

- Die in der Zubehör-Disk enthaltene Software und deren Urheberrechte sind im alleinigen Besitz der Steinberg Media Technologies GmbH.
- Das Kopieren der Software und die Vervielfältigung dieses Handbuchs als Ganzes oder in Teilen sind nur mit ausdrücklicher schriftlicher Genehmigung des Herstellers erlaubt.
- Yamaha übernimmt keinerlei Garantie hinsichtlich der Nutzung dieser Software und der dazugehörigen Dokumentation und kann nicht für die Folgen der Nutzung von Handbuch und Software verantwortlich gemacht werden.
- Diese Disc dient NICHT audiovisuellen Zwecken. Spielen Sie diese Disc nicht in einem CD-/DVD-Player ab. Anderenfalls können schwere Schäden am Player entstehen.
- Beachten Sie, dass Yamaha keine technische Unterstützung für die auf der Zubehör-Disc enthaltene DAW-Software gewährt.

Über die DAW-Software auf der Zubehör-Disc

Die Zubehör-Disc enthält DAW-Software sowohl für Windows als auch für Mac.

- HINWEIS**
- Achten Sie darauf, die DAW-Software im „Administrator“-Account zu installieren.
 - Um den fortwährenden Betrieb der DAW-Software auf der Zubehör-Disk einschließlich Support und anderer Vorteile zu gewährleisten, müssen Sie die Software registrieren und Ihre Software-Lizenz aktivieren, indem Sie die Software auf dem Computer starten, während dieser mit dem Internet verbunden ist. Klicken Sie auf die Schaltfläche „Jetzt registrieren“, die beim Starten der Software angezeigt wird, und füllen Sie dann alle für die Registrierung erforderlichen Felder aus. Wenn Sie die Software nicht registrieren, können Sie sie nach Ablauf einer gewissen Zeitdauer nicht mehr nutzen.
 - Doppelklicken Sie zur Installation auf einem Mac-Computer auf das Symbol „Cubase AI*.mpkg“ oder „Cubase AI* Start Center“.
„ * “ gibt die Stelle an, an der im tatsächlichen Symbolnamen die Versionsnummer angezeigt wird.

Für Informationen über die minimalen Systemanforderungen und die neuesten Informationen zu der auf der Disc befindlichen Software besuchen Sie folgende Website.
<<http://www.yamahasynth.com/>>

Über die Software-Unterstützung

Unterstützung der DAW-Software auf der Zubehör-Disc wird von Steinberg auf deren Website unter der folgenden Adresse gewährt.
<http://www.steinberg.net>

Sie können die Steinberg-Website auch über das Hilfemenü (Help) der enthaltenen DAW-Software erreichen. (Im Hilfemenü finden Sie auch die PDF-Anleitung und weitere Informationen zur Software.)

A propos du disque accessoire

AVIS SPECIAL

- Les logiciels fournis sur le disque accessoire et leurs copyrights sont la propriété exclusive de Steinberg Media Technologies GmbH.
- Toute copie du logiciel ou de ce mode d'emploi en tout ou en partie, par quelque moyen que ce soit, est expressément interdite sans le consentement écrit du fabricant.
- Yamaha n'offre aucune garantie quant à l'usage des logiciels ou de la documentation et ne peut être tenu pour responsable des résultats de l'usage de ce mode d'emploi et des logiciels.
- Ce disque n'est PAS un support audio/vidéo. N'essayez pas de le lire avec un lecteur de CD/DVD audio/vidéo. Vous risqueriez en effet d'endommager irrémédiablement ce dernier.
- Veuillez noter que Yamaha n'offre aucun support technique pour les logiciels DAW présents sur le disque accessoire.

A propos des logiciels DAW contenus sur le disque accessoire

Le disque accessoire contient des logiciels DAW pour Windows et Mac.

- NOTE**
- Prenez soin d'installer le logiciel DAW avec le compte « Administrateur ».
 - Pour bénéficier d'un usage ininterrompu des logiciels DAW contenus sur le disque accessoire ainsi que du support et d'autres avantages, vous devez obligatoirement enregistrer le logiciel et activer votre licence de logiciel en démarrant l'application sur un ordinateur connecté à Internet. Cliquez sur la touche « Enregistrer maintenant » qui apparaît au démarrage du logiciel, puis renseignez tous les autres champs requis pour l'enregistrement. Si vous n'enregistrez pas le produit, vous ne pourrez plus exécuter l'application l'expiration d'un délai spécifique.
 - Pour procéder à l'installation sur un ordinateur Mac, double-cliquez sur l'icône « Cubase AI*.mpkg » ou « Cubase AI* Start Center ».
« * » correspond au numéro de version dans le nom de l'icône.

Pour plus d'informations sur la configuration système minimale requise et les dernières informations sur les logiciels contenus sur le disque, consultez le site web ci-dessous.

<<http://www.yamahasynth.com/>>

A propos du support logiciel

Un support pour les logiciels DAW présents sur le disque accessoire est fourni sur le site web de Steinberg à l'adresse suivante.

<http://www.steinberg.net>

Vous pouvez en outre accéder au site de Steinberg via le menu Help des logiciels DAW fournis. (Le menu Help contient également le manuel PDF et d'autres informations sur les logiciels.)

Acerca del disco complementario

AVISO ESPECIAL

- El software que se incluye en el disco complementario y los derechos de copyright correspondientes al mismo son propiedad exclusiva de Steinberg Media Technologies GmbH.
- Está terminantemente prohibida la copia del software o la reproducción total o parcial de este manual por cualquier medio sin la autorización por escrito del fabricante.
- Yamaha no ofrece garantía o declaración alguna en relación con el uso del software y de la documentación, y no se responsabiliza de los resultados del uso de este manual ni del software.
- Este disco NO está pensado para una reproducción audio/visual. No intente reproducirlo en un reproductor de CD/DVD audio/visual, ya que se podrían causar daños irreparables en el reproductor.
- Tenga presente que Yamaha no ofrece asistencia técnica para el software DAW incluido en el disco complementario.

Acerca del software DAW incluido en el disco complementario

El disco complementario contiene software DAW para Windows y Mac.

NOTA

- Asegúrese de que instala el software DAW con la cuenta de administrador.
- Para usar de forma continua el software DAW del disco complementario, incluida asistencia técnica y otras ventajas, deberá registrarlo y activar su licencia iniciándolo con el ordenador conectado a Internet. Haga clic en el botón "Register Now" (registrar ahora) que aparece cuando se inicia el software, luego rellene todos los campos requeridos para el registro. Si no registra el software, no podrá usarlo después de un periodo limitado de tiempo.
- Para la instalación en equipos Mac, haga doble clic en el icono "Cubase AI*.mpkg" o en el icono "Cubase AI* Start Center".
" * " indica el lugar donde aparece el número de versión en el nombre del icono.

Para obtener detalles acerca de los requisitos mínimos del sistema y la información más reciente sobre el software incluido en el disco, visite el siguiente sitio Web.

<<http://www.yamahasynt.com/>>

Acerca de la asistencia para el software

La asistencia para el software DAW incluido en el disco complementario la presta Steinberg en su sitio Web en la dirección siguiente.

<http://www.steinberg.net>

También puede visitar el sitio de Steinberg desde el menú Ayuda del software DAW incluido. (El menú Ayuda también incluye el manual en formato PDF y otra información sobre el software.)

For details of products, please contact your nearest Yamaha representative or the authorized distributor listed below.

Pour plus de détails sur les produits, veuillez-vous adresser à Yamaha ou au distributeur le plus proche de vous figurant dans la liste suivante.

Die Einzelheiten zu Produkten sind bei Ihrer unten aufgeführten Niederlassung und bei Yamaha Vertragshändlern in den jeweiligen Bestimmungsländern erhältlich.

Para detalles sobre productos, contacte su tienda Yamaha más cercana o el distribuidor autorizado que se lista debajo.

NORTH AMERICA

CANADA

Yamaha Canada Music Ltd.
135 Milner Avenue, Scarborough, Ontario,
M1S 3R1, Canada
Tel: 416-298-1311

U.S.A.

Yamaha Corporation of America
6600 Orangethorpe Ave., Buena Park, Calif. 90620,
U.S.A.
Tel: 714-522-9011

CENTRAL & SOUTH AMERICA

MEXICO

Yamaha de México S.A. de C.V.
Calz. Javier Rojo Gómez #1149,
Col. Guadalupe del Moral
C.P. 09300, México, D.F., México
Tel: 55-5804-0600

BRAZIL

Yamaha Musical do Brasil Ltda.
Rua Joaquim Floriano, 913 - 4º andar, Itaim Bibi,
CEP 04534-013 Sao Paulo, SP. BRAZIL
Tel: 011-3704-1377

ARGENTINA

Yamaha Music Latin America, S.A.
Sucursal de Argentina
Olga Cossettini 1553, Piso 4 Norte
Madero Este-C1107CEK
Buenos Aires, Argentina
Tel: 011-4119-7000

PANAMA AND OTHER LATIN AMERICAN COUNTRIES/ CARIBBEAN COUNTRIES

Yamaha Music Latin America, S.A.
Torre Banco General, Piso 7, Urbanización Marbella,
Calle 47 y Aquilino de la Guardia,
Ciudad de Panamá, Panamá
Tel: +507-269-5311

EUROPE

THE UNITED KINGDOM/IRELAND

Yamaha Music U.K. Ltd.
Sherbourne Drive, Tilbrook, Milton Keynes,
MK7 8BL, England
Tel: 01908-366700

GERMANY

Yamaha Music Europe GmbH
Siemensstraße 22-34, 25462 Rellingen, Germany
Tel: 04101-3030

SWITZERLAND/LIECHTENSTEIN

Yamaha Music Europe GmbH
Branch Switzerland in Zürich
Seefeldstrasse 94, 8008 Zürich, Switzerland
Tel: 01-383 3990

AUSTRIA

Yamaha Music Europe GmbH Branch Austria
Schleiergasse 20, A-1100 Wien, Austria
Tel: 01-60203900

CZECH REPUBLIC/SLOVAKIA/ HUNGARY/SLOVENIA

Yamaha Music Europe GmbH Branch Austria
Schleiergasse 20, A-1100 Wien, Austria
Tel: 01-602039025

POLAND/LITHUANIA/LATVIA/ESTONIA

Yamaha Music Europe GmbH
Branch Sp.z o.o. Oddział w Polsce
ul. 17 Stycznia 56, PL-02-146 Warszawa, Poland
Tel: 022-500-2925

THE NETHERLANDS/ BELGIUM/LUXEMBOURG

Yamaha Music Europe Branch Benelux
Clarissenhof 5-b, 4133 AB Vianen, The Netherlands
Tel: 0347-358 040

FRANCE

Yamaha Musique France
BP 70-77312 Marne-la-Vallée Cedex 2, France
Tel: 01-64-61-4000

ITALY

Yamaha Musica Italia S.P.A.
Combo Division
Viale Italia 88, 20020 Lainate (Milano), Italy
Tel: 02-935-771

SPAIN/PORTUGAL

Yamaha Música Ibérica, S.A.
Ctra. de la Coruna km. 17, 200, 28230
Las Rozas (Madrid), Spain
Tel: 91-639-8888

GREECE

Philippos Nakas S.A. The Music House
147 Skiathou Street, 112-55 Athens, Greece
Tel: 01-228 2160

SWEDEN

Yamaha Scandinavia AB
J. A. Wettergrens Gata 1, Box 30053
S-400 43 Göteborg, Sweden
Tel: 031 89 34 00

DENMARK

YS Copenhagen Liaison Office
Generatorvej 6A, DK-2730 Herlev, Denmark
Tel: 44 92 49 00

FINLAND

F-Musiikki Oy
Kluuvikatu 6, P.O. Box 260,
SF-00101 Helsinki, Finland
Tel: 09 618511

NORWAY

Norsk filial av Yamaha Scandinavia AB
Grini Næringspark 1, N-1345 Østerås, Norway
Tel: 67 16 77 70

ICELAND

Skifan HF
Skeifan 17 P.O. Box 8120, IS-128 Reykjavik, Iceland
Tel: 525 5000

RUSSIA

Yamaha Music (Russia)
Room 37, bld. 7, Kievskaya street, Moscow,
121059, Russia
Tel: 495 626 5005

OTHER EUROPEAN COUNTRIES

Yamaha Music Europe GmbH
Siemensstraße 22-34, 25462 Rellingen, Germany
Tel: +49-4101-3030

AFRICA

Yamaha Corporation,
Asia-Pacific Sales & Marketing Group
Nakazawa-cho 10-1, Naka-ku, Hamamatsu,
Japan 430-8650
Tel: +81-53-460-2313

MIDDLE EAST

TURKEY/CYPRUS

Yamaha Music Europe GmbH
Siemensstraße 22-34, 25462 Rellingen, Germany
Tel: 04101-3030

OTHER COUNTRIES

Yamaha Music Gulf FZE
LOB 16-513, P.O.Box 17328, Jubel Ali,
Dubai, United Arab Emirates
Tel: +971-4-881-5868

ASIA

THE PEOPLE'S REPUBLIC OF CHINA

Yamaha Music & Electronics (China) Co.,Ltd.
2F, Yunhedasha, 1818 Xinzha-lu, Jingan-qu,
Shanghai, China
Tel: 021-6247-2211

HONG KONG

Tom Lee Music Co., Ltd.
11/F., Silvercord Tower 1, 30 Canton Road,
Tsimshatsui, Kowloon, Hong Kong
Tel: 2737-7688

INDIA

Yamaha Music India Pvt. Ltd.
5F Ambience Corporate Tower Ambience Mall Complex
Ambience Island, NH-8, Gurgaon-122001, Haryana, India
Tel: 0124-466-5551

INDONESIA

PT. Yamaha Musik Indonesia (Distributor)
PT. Nusantik
Gedung Yamaha Music Center, Jalan Jend. Gatot
Subroto Kav. 4, Jakarta 12930, Indonesia
Tel: 021-520-2577

KOREA

Yamaha Music Korea Ltd.
8F, 9F, Dongsung Bldg. 158-9 Samsung-Dong,
Kangnam-Gu, Seoul, Korea
Tel: 02-3467-3300

MALAYSIA

Yamaha Music (Malaysia) Sdn., Bhd.
Lot 8, Jalan Perbandaran, 47301 Kelana Jaya,
Petaling Jaya, Selangor, Malaysia
Tel: 03-78030900

PHILIPPINES

Yupangco Music Corporation
339 Gil J. Puyat Avenue, P.O. Box 885 MCPO,
Makati, Metro Manila, Philippines
Tel: 819-7551

SINGAPORE

Yamaha Music (Asia) Pte., Ltd.
#03-11 A-Z Building
140 Paya Lebor Road, Singapore 409015
Tel: 6747-4374

TAIWAN

Yamaha KHS Music Co., Ltd.
3F, #6, Sec.2, Nan Jing E. Rd. Taipei.
Taiwan 104, R.O.C.
Tel: 02-2511-8688

THAILAND

Siam Music Yamaha Co., Ltd.
4, 6, 15 and 16th floor, Siam Motors Building,
891/1 Rama 1 Road, Wangmai,
Pathumwan, Bangkok 10330, Thailand
Tel: 02-215-2622

OTHER ASIAN COUNTRIES

Yamaha Corporation,
Asia-Pacific Sales & Marketing Group
Nakazawa-cho 10-1, Naka-ku, Hamamatsu,
Japan 430-8650
Tel: +81-53-460-2313

OCEANIA

AUSTRALIA

Yamaha Music Australia Pty. Ltd.
Level 1, 99 Queensbridge Street, Southbank,
Victoria 3006, Australia
Tel: 3-9693-5111

NEW ZEALAND

Music Works LTD
P.O.BOX 6246 Wellesley, Auckland 4680,
New Zealand
Tel: 9-634-0099

COUNTRIES AND TRUST TERRITORIES IN PACIFIC OCEAN

Yamaha Corporation,
Asia-Pacific Sales & Marketing Group
Nakazawa-cho 10-1, Naka-ku, Hamamatsu,
Japan 430-8650
Tel: +81-53-460-2313

HEAD OFFICE Yamaha Corporation, Digital Musical Instruments Division
Nakazawa-cho 10-1, Naka-ku, Hamamatsu, Japan 430-8650
Tel: +81-53-460-2432



Yamaha Web Site (English only)
<http://www.yamahasyth.com/>

Yamaha Manual Library
<http://www.yamaha.co.jp/manual/>

C.S.G., Pro Audio Division
© 2007-2011 Yamaha Corporation

111POGR*.*-01D0

ZA68630