

SILENT *Violin*TM

SV130/SV130S

Owner's Manual

Thank you for purchasing the Yamaha SILENT ViolinTM. In order to obtain the maximum performance and enjoyment from your SILENT ViolinTM, we urge you to read this Owner's Manual thoroughly before using the instrument. Please keep this Owner's Manual in a safe place for later reference.

Contents

Precautions	3
Main Body/Accessories	4
Nomenclature	5
Setup	7
■ Tuning	7
■ The Shoulder Rest	8
■ The Bow (supplied with the SV130S)	8
■ Changing Strings	8
Power Supply	10
■ Using Batteries	10
■ Supplying AC Power	10
Using the Controls	11
The Reverb	11
Connecting External Devices	12
■ AUX IN jack	13
■ LINE OUT jack	13
Specifications	14

SPECIAL MESSAGE SECTION

This product utilizes batteries or an external power supply (adaptor). DO NOT connect this product to any power supply or adaptor other than one described in the manual, on the name plate, or specifically recommended by Yamaha.

This product should be used only with the components supplied or; a cart, rack, or stand that is recommended by Yamaha. If a cart, etc., is used, please observe all safety markings and instructions that accompany the accessory product.

SPECIFICATIONS SUBJECT TO CHANGE: The information contained in this manual is believed to be correct at the time of printing. However, Yamaha reserves the right to change or modify any of the specifications without notice or obligation to update existing units.

Do not attempt to service this product beyond that described in the user-maintenance instructions. All other servicing should be referred to qualified service personnel.

This product, either alone or in combination with an amplifier and headphones or speaker/s, may be capable of producing sound levels that could cause permanent hearing loss. DO NOT operate for long periods of time at a high volume level or at a level that is uncomfortable. If you experience any hearing loss or ringing in the ears, you should consult an audiologist.

IMPORTANT: The louder the sound, the shorter the time period before damage occurs.

NOTICE: Service charges incurred due to a lack of knowledge relating to how a function or effect works (when the unit is operating as designed) are not covered by the manufacturer's warranty, and are therefore the owner's responsibility. Please study this manual carefully and consult your dealer before requesting service.

ENVIRONMENTAL ISSUES: Yamaha strives to produce products that are both user safe and environmentally friendly. We sincerely believe that our products and the production methods used to produce them meet these goals. In keeping with both the letter and the spirit of the law, we want you to be aware of the following:

Battery Notice: This product MAY contain a small non-rechargeable battery which (if applicable) is soldered in place. The average life span of this type of battery is approximately five years. When replacement becomes necessary, contact a qualified service representative to perform the replacement.

This product may also use "household" type batteries. Some of these may be rechargeable. Make sure that the battery being charged is a rechargeable type and that the charger is intended for the battery being charged.

When installing batteries, do not mix old batteries with new, or with batteries of a different type. Batteries MUST be installed correctly. Mismatches or incorrect installation may result in overheating and battery case rupture.

Warning: Do not attempt to disassemble or incinerate any battery. Keep all batteries away from children. Dispose of used batteries promptly and as regulated by the laws in your area. Note: Check with any retailer of household type batteries in your area for battery disposal information.

Disposal Notice: Should this product become damaged beyond repair, or for some reason its useful life is considered to be at an end, please observe all local, state, and federal regulations that relate to the disposal of products that contain lead, batteries, plastics, etc. If your dealer is unable to assist you, please contact Yamaha directly.

NAMEPLATE LOCATION: The nameplate is located on the bottom of the product. The model number, serial number, power requirements, etc., are located on this plate. You should record the model number, serial number, and the date of purchase in the spaces provided below and retain this manual as a permanent record of your purchase.

Model

Serial No.

Purchase Date

92-BP

PLEASE KEEP THIS MANUAL

FCC INFORMATION (U.S.A.)

1. IMPORTANT NOTICE: DO NOT MODIFY THIS UNIT!

This product, when installed as indicated in the instructions contained in this manual, meets FCC requirements. Modifications not expressly approved by Yamaha may void your authority, granted by the FCC, to use the product.

2. IMPORTANT:

When connecting this product to accessories and/or another product use only high-quality shielded cables. Cable/s supplied with this product MUST be used. Follow all installation instructions. Failure to follow instructions could void your FCC authorization to use this product in the USA.

3. NOTE:

This product has been tested and found to comply with the requirements listed in FCC Regulations, Part 15 for Class "B" digital devices. Compliance with these requirements provides a reasonable level of assurance that your use of this product in a residential environment will not result in harmful interference with other electronic devices. This equipment generates/uses radio frequencies and, if not installed and used according to the instructions found in the user's manual, may cause interference harmful to the operation of

other electronic devices. Compliance with FCC regulations does not guarantee that interference will not occur in all installations. If this product is found to be the source of interference, which can be determined by turning the unit "OFF" and "ON", please try to eliminate the problem by using one of the following measures:

Relocate either this product or the device that is being affected by the interference.

Utilize power outlets that are on different branch (circuit breaker or fuse) circuits or install AC line filter/s.

In the case of radio or TV interference, relocate/reorient the antenna. If the antenna lead-in is 300 ohm ribbon lead, change the lead-in to co-axial type cable.

If these corrective measures do not produce satisfactory results, please contact the local retailer authorized to distribute this type of product. If you cannot locate the appropriate retailer, please contact Yamaha Corporation of America, Electronic Service Division, 6600 Orangethorpe Ave, Buena Park, CA 90620

The above statements apply ONLY to those products distributed by Yamaha Corporation of America or its subsidiaries.

CANADA

THIS DIGITAL APPARATUS DOES NOT EXCEED THE "CLASS B" LIMITS FOR RADIO NOISE EMISSIONS FROM DIGITAL APPARATUS SET OUT IN THE RADIO INTERFERENCE REGULATION OF THE CANADIAN DEPARTMENT OF COMMUNICATIONS.

LE PRESENT APPAREIL NUMERIQUE N'EMET PAS DE BRUITS RADIOELECTRIQUES DEPASSANT LES LIMITES APPLICABLES AUX APPAREILS NUMERIQUES DE LA "CLASSE B" PRESCRITES DANS LE REGLEMENT SUR LE BROUILLAGE RADIOELECTRIQUE EDICTE PAR LE MINISTERE DES COMMUNICATIONS DU CANADA.

- This applies only to products distributed by Yamaha Canada Music Ltd.
- Ceci ne s'applique qu'aux produits distribués par Yamaha Canada Musique Ltée.

Your SILENT Violin™ will give you years of reliable service if you follow the simple rules given below:

■ Location

Do not expose it to the following conditions to avoid deformation, discoloration, or more serious damage.

- Direct sunlight (e.g. near a window).
- High temperatures (e.g. near a heat source, outside, or in a car during the daytime).
- Excessive humidity.
- Excessive dust.
- Strong vibration.

■ Power Supply

- Turn the power switch OFF when not in use.
- If you use an AC power adaptor, unplug the adaptor from the AC outlet if not to be used for an extended period of time.
- Unplug the AC power adaptor during electric storms.
- Avoid plugging the AC power adaptor into the same AC outlet as appliances with high power consumption, such as electric heaters or ovens. Also avoid using multi-plug adaptors since these can result in reduced sound quality and possibly damage.

■ Turn Power OFF When Making Connections

- To avoid damage to the SILENT Violin™ and other devices to which it is connected (a sound system, for example), turn the power switches of all related devices OFF prior to connecting or disconnecting audio cables.

■ Handling and Transport

- Never apply excessive force to the controls, connectors or other parts.
- Always unplug cables by gripping the plug firmly, not by pulling on the cable.
- Disconnect all cables before moving the unit.
- Physical shocks caused by dropping, bumping, or placing heavy objects on the unit can result in scratches and more serious damage.

■ Cleaning

- Clean the cabinet and panel with a dry soft cloth.
- A slightly damp cloth may be used to remove stubborn grime and dirt.
- Never use cleaners such as alcohol or thinner.
- Avoid placing vinyl objects on top of the unit (vinyl can stick to and discolor the surface).

■ Electrical Interference

- This unit contains electric circuitry and may cause interference if placed too close to radio or television receivers. If this occurs, move it further away from the affected equipment.

YAMAHA is not responsible for damage caused by improper handling or operation.

Information for Users on Collection and Disposal of Old Equipment and used Batteries



These symbols on the products, packaging, and/or accompanying documents mean that used electrical and electronic products and batteries should not be mixed with general household waste. For proper treatment, recovery and recycling of old products and used batteries, please take them to applicable collection points, in accordance with your national legislation and the Directives 2002/96/EC and 2006/66/EC.

By disposing of these products and batteries correctly, you will help to save valuable resources and prevent any potential negative effects on human health and the environment which could otherwise arise from inappropriate waste handling.

For more information about collection and recycling of old products and batteries, please contact your local municipality, your waste disposal service or the point of sale where you purchased the items.

[For business users in the European Union]

If you wish to discard electrical and electronic equipment, please contact your dealer or supplier for further information.

[Information on Disposal in other Countries outside the European Union]

These symbols are only valid in the European Union. If you wish to discard these items, please contact your local authorities or dealer and ask for the correct method of disposal.

Note for the battery symbol (bottom two symbol examples):

This symbol might be used in combination with a chemical symbol. In this case it complies with the requirement set by the Directive for the chemical involved.



Cd

Main Body/Accessories

After opening the packaging, please check that all the parts listed below are included.

SV130

- Violin
SV130

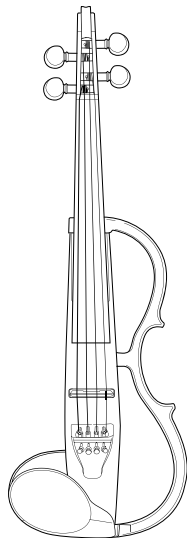

- Bridge

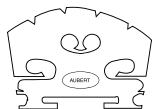

- SUM-3 (AA) size Manganese batteries x2
* The supplied battery is for demonstration purposes.

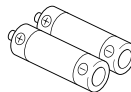

- Audio cable

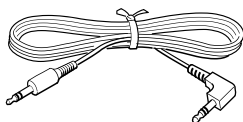

- Stereo earphones

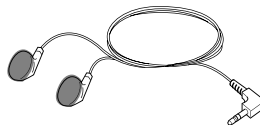

- Shoulder rest : KUN Yamaha Special

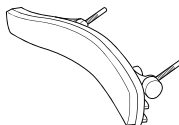

SV130S

The following items are in addition to the SV130 package.

- Bow : 4/4 size



- Hard case

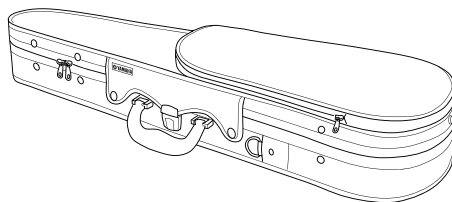

- Rosin : PIRASTRO Schwarz 9005



Nomenclature

● Front

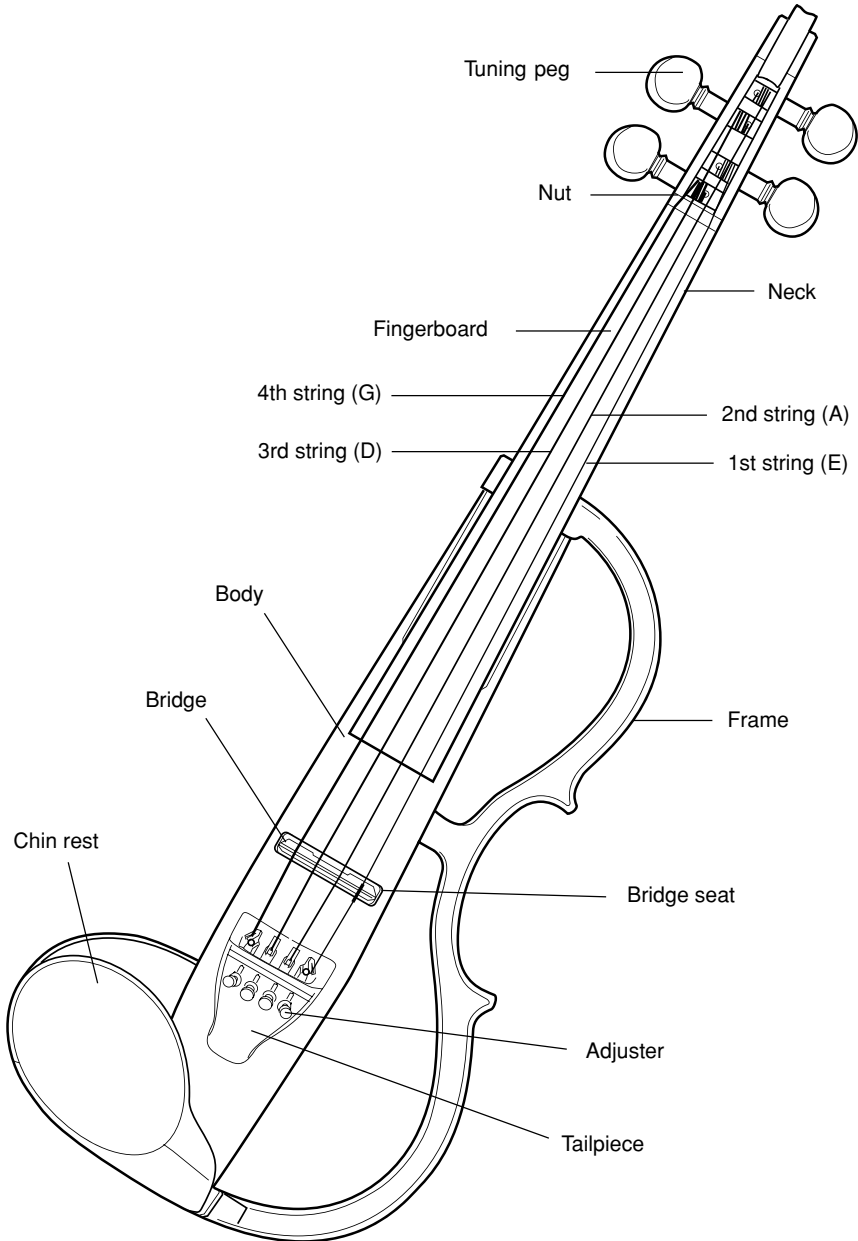

● Controls

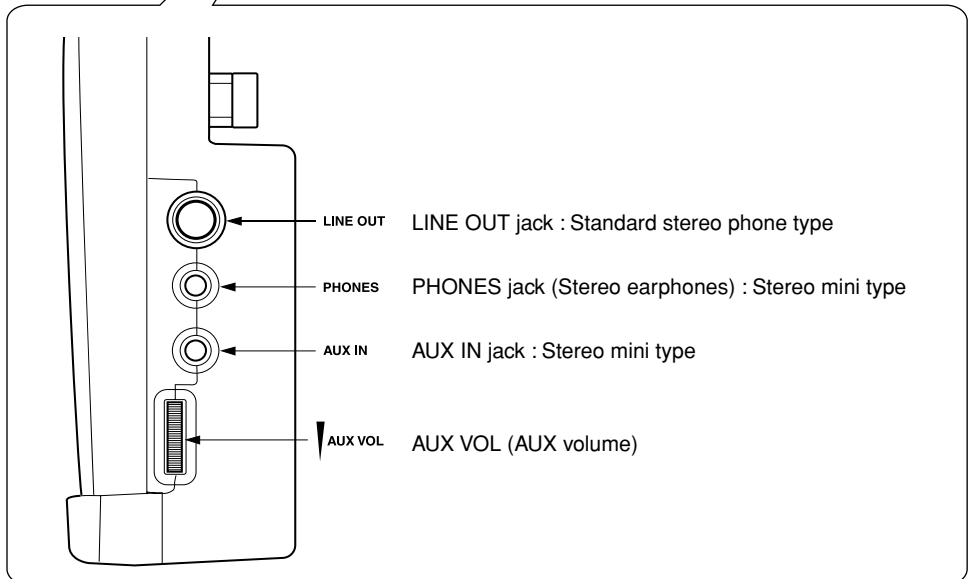
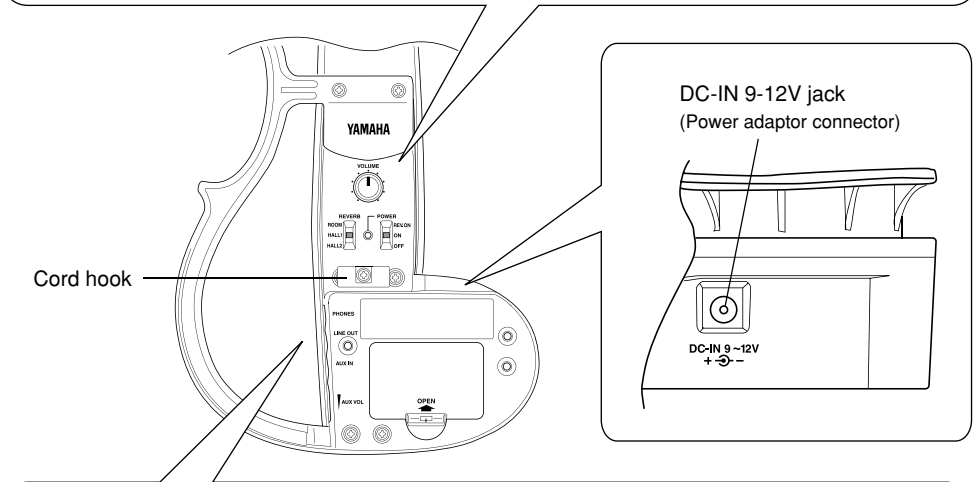
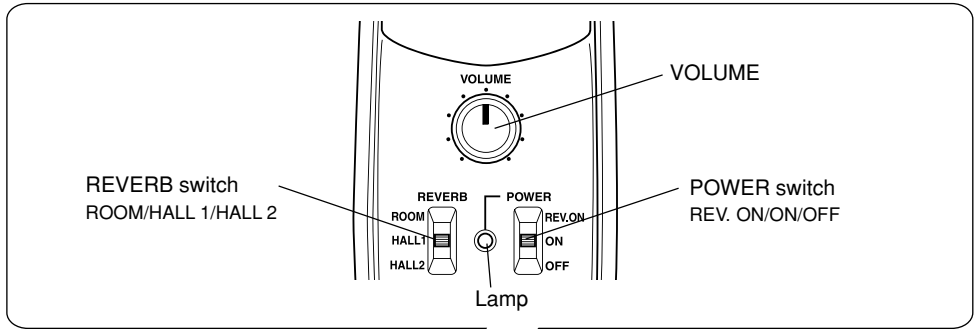

Setup

■ Tuning

The SILENT Violin™ is shipped from the factory with the bridge unfitted. First, set up the bridge and then proceed with tuning.

- The lower side of the bridge supports the 1st string (E), the higher side supports the 4th string (G). Make sure the bridge is placed properly, then set the bridge in the bridge seat. The side of the bridge with the (AUBERT) logo should face the tailpiece.
- Ensure that the bridge stands vertically. If it leans to one side, use both hands to adjust. Make sure that each string passes over the corresponding slits in the bridge.
- The strings are tuned to the following pitches. The 1st string is tuned to E, the 2nd string to A, the 3rd string to D, and the 4th string to G. Use a piano, tuning fork, tuner, etc., and adjust the pitch of each string using the tuning pegs. When rotating the peg, apply firm pressure towards the head stock.

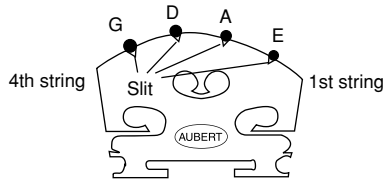
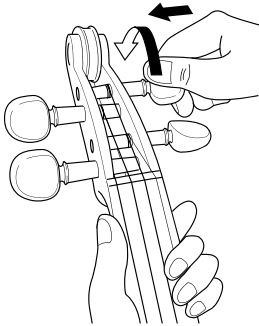

[Looking from the tailpiece]

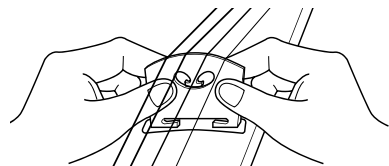
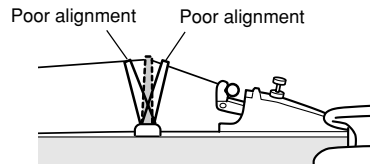
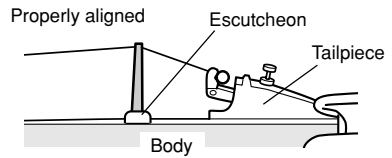

[Bridge is placed vertically]

- After tuning is complete, make sure the bridge is still properly aligned. If the bridge is leaning in either direction, slightly loosen the strings and carefully re-align the bridge using both hands.
- Finally, use the adjuster to fine tune the strings.

Caution

- If the adjuster is too loose, it could produce noise while playing.



Don't loosen too much.

■ The Shoulder Rest

The shoulder rest accessory is supplied to give you added support when holding the violin between your shoulder and chin. Refer to the illustration and insert the shoulder rest into the holes provided (on the rear of the instrument) to suit your playing position.

- If the instrument can be held comfortably without the shoulder rest, the use of the rest won't be necessary.
- The pins on the shoulder rest slightly point outward. When you attach the shoulder rest, insert one pin about half way into its hole, and then slightly bend the shoulder rest so that the second pin aligns with the corresponding hole, and insert.

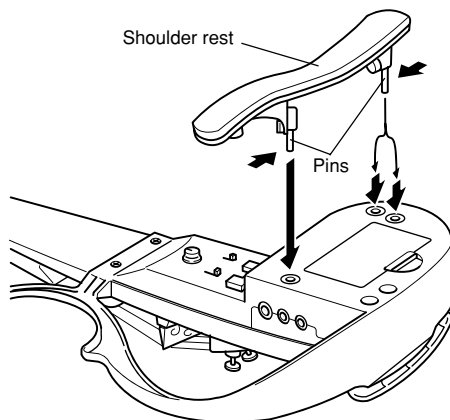

■ The Bow (supplied with the SV130S)

- Apply rosin to the bow hairs before using. Before using the bow for the first time, apply rosin carefully and evenly to the whole bow. From the 2nd time, apply a small amount of rosin to the bow hairs.
- Loosen the bow whenever the bow is not used.
- If the bow is not used for an extended period of time, the hairs may suffer damage caused by insects. Please treat with care.

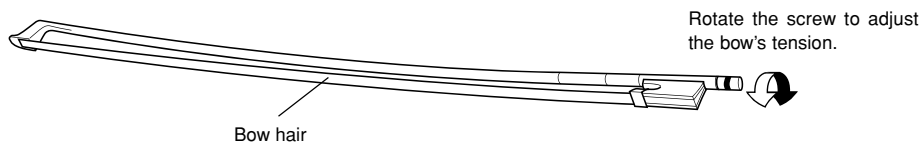

■ Changing Strings

As the strings get old, sound quality will gradually decrease, and it will become difficult to tune the instrument. Change the strings as soon as you think they are getting old.

- The end of the strings are sharp and can cut fingers. Use caution when changing strings.
- When changing or adjusting strings, do not put your face close to the instrument. The string may suddenly break resulting in eye or other unexpected injuries.

Winding the Strings

- 1 Before you string the instrument, set the adjuster so that it is in the middle of its adjustment range. (All adjusters)

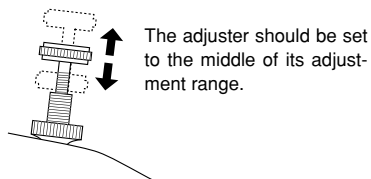

2 Place the ball (on the end of the string) in the notch on the adjuster. Make sure the ball is properly inserted in the adjuster's notch.

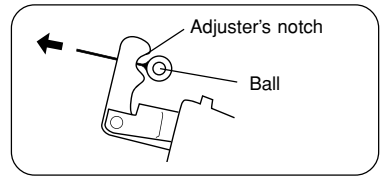

3 Insert the other end of the string into the hole on the tuning peg. Ensure that the string is wound on the right side of the hole for the 1st (E) and 2nd (A) strings, and on the left side of the hole for the 3rd (D) and 4th (G) strings. Next, check the bridge does not fall over as you wind the strings. Ensure that the strings pass over the corresponding slits on the top of the bridge. (Make sure that the bridge is standing vertically.)

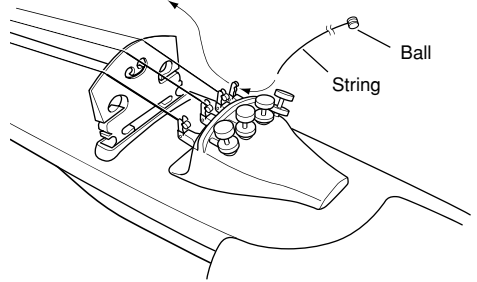

The 1st string (E) has a protective tube on it. Make sure the tube is placed on the bridge as shown in the illustration.

4 Use a piano, tuning fork, tuner, etc., and adjust the pitch of each string using the tuning pegs.

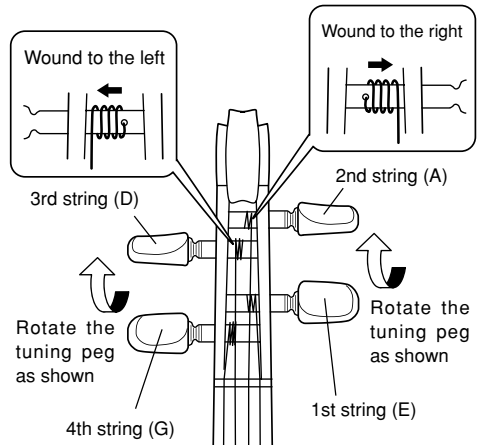

5 Finally, use the adjuster to fine tune the strings.

Caution If the adjuster is too loose, it could produce noise while playing.

Don't loosen too much.

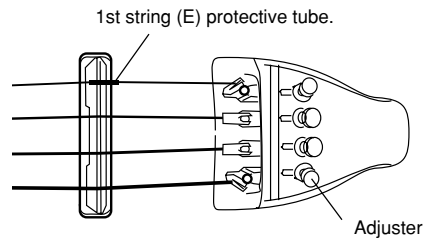

• When the instrument is not going to be used for an extended period of time, loosen the strings until the pitch drops a whole tone.

Power Supply

The SILENT Violin™ can be operated with either battery or AC power. Always turn the power switch (OFF/ON/REV.ON) on the rear panel OFF before making AC power connections or replacing batteries.

■ Using Batteries

- 1 Open the battery compartment situated on the back of the SILENT Violin™.
- 2 Insert the two batteries supplied (SUM-3 (AA) size). Take careful note of the polarity markings as shown in the illustration above, and insert the batteries.
- 3 Replace the battery compartment cover.

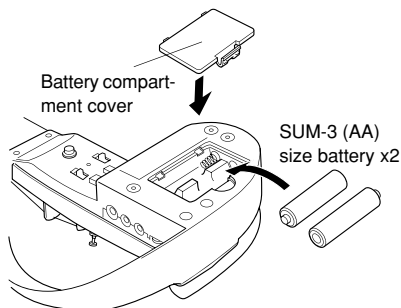

* For customers in the Netherlands

Bij dit produkt zijn batterijen geleverd. Wanneer deze leeg zijn, moet u ze niet weggooien maar inleveren als KCA.



Slide the **POWER** switch to the **ON** position, the lamp will light green. Slide the switch to the **REV. ON** position, the lamp will flash red. When battery power is low, the lamp's color changes to orange, the sound becomes distorted, the Reverb does not properly function, and noise becomes audible. When one of these symptoms appears, take note of the following cautions and replace the batteries.



- Always follow the +/- signs when inserting the batteries. Improper insertion may result in fire.
- Always replace worn batteries with a complete set of new batteries. Never mix new and old batteries. Do not mix different types of batteries (alkaline and manganese, or batteries from different manufacturers, or different types by the same manufacturer). Doing so may result in fire.
- To prevent possible damage to the unit due to battery leakage and unnecessary power drain, remove the batteries from the unit when it is not going to be used for an extended period of time.
- The supplied battery is for demonstration purposes.

■ Supplying AC Power

AC adaptor is optional, please purchase the optional power adaptor PA-3C.

- 1 Plug the adaptor's DC output cable into the SILENT Violin™'s DC IN 9-12V jack located on the side of the instrument, making sure it is firmly inserted into the jack.
- 2 Plug the AC adaptor into a convenient wall AC power socket.

- Battery power is automatically disconnected when the AC adaptor is connected.
- When using an AC adaptor, make sure you use only the appointed compatible adaptor. The use of an incompatible adaptor may result in damage to the instrument or cause fire, etc. Please use with caution.

Using the Controls

- 1 Slide the **POWER** switch, located on the rear of the instrument, to its **ON** position. The lamp will light green.
- 2 Connect the stereo earphones to the **PHONES** jack on the side of the instrument, make sure that the L & R side earphones are used in the correct ears.
- 3 Rotate the **VOLUME** dial to the desired playing level.

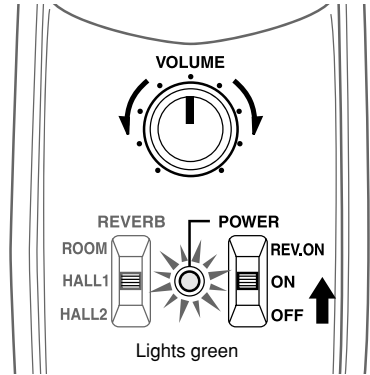

- Do not operate at high volume levels when using earphones. Doing so can lead to irreparable damage to your hearing.

The Reverb

The **SILENT Violin™** incorporates Yamaha's DSP reverb technology. Play while trying out the three types of reverb.

- 1 Slide the **POWER** switch to the **REV. ON** position, the lamp will light red, and reverb will be applied to the **SILENT Violin™**'s sound.
- 2 Slide the **REVERB** switch to select one of the three reverb modes.

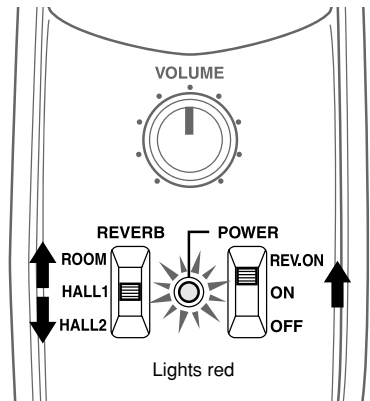

- **ROOM** mode this reverb simulates the natural reverberation found in a room.
- **HALL 1** mode this reverb simulates the natural reverberation found in a hall.
- **HALL 2** mode the same reverb simulation as **HALL 1** but with a longer decay time.

Connecting External Devices

SILENT Violin™

SUM-3 (AA)
size battery x2



or

Power Adaptor
(Option)

Electric
Outlet



DC-IN 9-12V

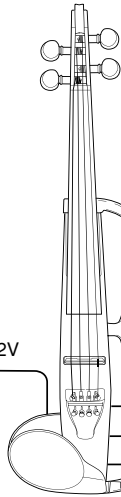

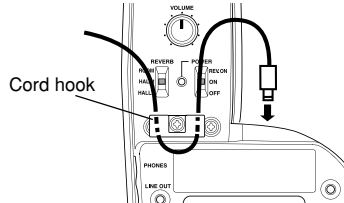

• Using the cord hook

Wrap the power adaptor's cord around the cord hook (prevents cord from being unplugged).





Stereo Earphones

CD Player

MD Player

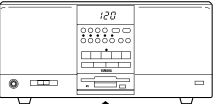
Cassette Player



Electronic Metronome

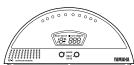

Powered Speaker

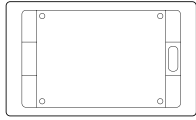

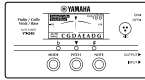

Electronic Tuner

P.A. Mixer, Recording Mixer

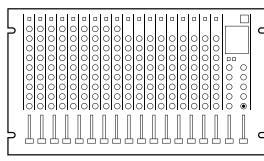

■ AUX IN jack

- The AUX IN jack, located on the side of the instrument, can be used to connect an external stereo signal source to the SILENT Violin™. Connecting the audio output of a CD player, cassette player, etc. to the instrument allows you to play along with the external audio source.
- The AUX IN jack's signal level can be controlled with the AUX. VOL control.

■ LINE OUT jack

- The LINE OUT jack, located on the side panel, delivers the stereo signal of the SILENT Violin™ to external audio equipment. Use an audio cable to connect the instrument to the audio input jack of external speakers, mixing console, cassette player, etc. to listen from external audio equipment or recording. You can also connect this jack to the INPUT jack on an electronic tuner and tune the SILENT Violin™ like an electronic instrument using the instrument's output signal.

- **Before connecting the SILENT Violin™ to any external devices, make sure that the power of all related devices is turned OFF. Set the volume level of any external audio sources to the minimum level before connecting anything. High volume settings could cause damage to the equipment and your hearing.**
- **If a connection cord is unplugged while the power is ON, it may result in damage to the equipment. The sudden shock to your ears may be great, so please use with care.**
- **Be careful not to step on the cord. The cord may break, equipment may be damaged, and this may cause a substantial shock to your ears.**
- **The signal from the SILENT Violin™'s output jacks must NEVER be returned to the AUX IN jack, either directly or through external equipment. Doing so will result in feedback which may cause damage to the internal electronics.**
- **Commercially available mini plug cables sometimes are equipped with plugs featuring a larger base (grip) diameter (see A in illustration on the right) which may cause faulty contact when used with this instrument.**
Please make sure to use a audio cable identical to the one supplied with the instrument.

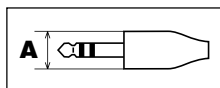

Specifications

Neck	Maple
Body	Spruce
Fingerboard	Ebony
Tuning Pegs	Ebony and resin hybrid type
Bridge	Maple (Aubert)
Frame/Chin Rest/Tailpiece	ABS Resin
Adjuster	4 pieces (Wittner)
Strings	Ball-end type
Sensor	Piezo pick-up (underneath the bridge)
Connectors/Controls	<ul style="list-style-type: none">• Headphone Output• AUX IN (w/Volume Control)• LINE OUT• Volume• Reverb Switch (ROOM/HALL 1/HALL 2)• POWER Switch (OFF/ON/REV. ON)
Power	<ul style="list-style-type: none">• SUM-3 (AA) size battery x2 / AC Adaptor dual power source
Battery Life (Continuous Use)	
Using Manganese batteries	
• Without Reverb (POWER Switch "ON")	approximately 20 hours
• With Reverb (POWER Switch "REV. ON")	approximately 4 hours
Using Alkaline batteries	
• Without Reverb (POWER Switch "ON")	approximately 60 hours
• With Reverb (POWER Switch "REV. ON")	approximately 12 hours
String Length	328 mm (12-15/16")
Dimensions	587 (L) x 195 (W) x 110 (H) mm 23-1/8" (L) x 7-11/16" (W) x 4-5/16" (H)
Weight (with batteries)	650g (1 lbs. 7 oz.)

* Design and specifications are subject to change without notice.

