



User Guide

AV Receiver

AVENTAGE

RX-A6A

musicCast **EN**

CONTENTS

BEFORE USING THE UNIT 10

Read me first	10
How to use this guide	10
Glossary	11
Checking the accessories	12
Checking the accessories	12
Using the remote control	14
Insert the batteries in the remote control	14
Operating range of the remote control	15

FEATURES 16

What you can do with the unit	16
Useful applications	23
AV SETUP GUIDE	23
MusicCast Controller	24

PART NAMES AND FUNCTIONS 25

Unit body	25
Part names and functions of the front panel	25
Front display	27
Part names and functions of the rear panel	32
Remote control	34
Part names and functions of the remote control	34

PREPARATIONS 37

Before starting	37
Names and functions of speakers	37
Flow of preparations	39
How to place speakers (speaker systems)	41
Speaker systems recommended to the unit (basic setup)	41
Other speaker systems (basic setup)	43
Speaker systems using the unit's internal amplifier (advanced setup)	60
Speaker systems using an external power amplifier (advanced setup)	73

Connecting speakers	84
Speaker requirements	84
Cable requirements	85
How to connect speakers	86
Connecting a TV	89
HDMI connection with a TV	89
HDMI connection with another TV or a projector	91
Connecting playback devices	92
HDMI connection with a video device such as a BD/DVD player	92
Connection other than HDMI with a playback device	93
Connecting the radio antennas	97
Connecting the FM antenna	97
Connecting the AM antenna	98
Connecting the DAB/FM antenna	100
Preparing for connecting to a network	101
Network connection of the unit	101
Connecting a network cable (wired connection)	102
Preparing wireless antennas (wireless connection)	103
Connecting other devices	104
Connecting a device compatible with the trigger function	104
Operating the unit from another room (remote connection)	105
Turning on the power of the unit	107
Plugging in the power cable	107
Setting the power to on/standby (Main zone)	108
Selecting the menu language	109
Selecting the menu language	109
Setting MusicCast	110
What is MusicCast	110
Using MusicCast Controller	111
Adding the unit to the MusicCast network	112
Using the MusicCast Surround function	113
Configuring wireless speakers	113
Configuring the speaker settings	115
Flow of the speaker configurations	115
Assigning speaker configuration	118
Optional measurement of YPAO	119
Configuring the speaker settings automatically based on the YPAO measurement results	121
Error messages from YPAO	129
Warning messages from YPAO	130

ENJOYING SOUND**131**

Enjoying sound field effects	131
Selecting your favorite sound mode	131
Playing back with surround effects optimized for the scene (SURROUND:AI)	132
Enjoying 3-dimensional sound fields	133
Enjoying sound field effects optimized for the type of content	134
Enjoying sound field effects without surround speakers (Virtual CINEMA DSP)	137
Enjoying surround sound with 5 speakers placed in front (Virtual CINEMA FRONT)	138
Enjoying surround sound with headphones (SILENT CINEMA)	139
Enjoying unprocessed playback	140
Enjoying original sound (straight decode)	140
Enjoying multichannel playback without sound field effects (surround decoder)	141
Enjoying higher quality playback (Pure Direct)	142
Enjoying 3-dimensional sound	143
Enjoying Dolby Atmos® and DTS:X™	143
Enjoying AURO-3D®	144
Enjoying favorite sound	145
Enjoying more powerful sound to the audio source (Compressed Music Enhancer)	145
Enhancing the low-frequency range from the subwoofer	146
Enjoying powerful sound at low volume	147
Making easy to hear the dialogue sounds	148
Enjoying bass sound with small speakers (Extra Bass)	149
Enjoying sound better	150

PLAYBACK**151**

Basic playback procedure	151
Basic procedure for playing back video and music	151
Selecting an HDMI output jack	152
Item names and functions of the playback screen	153
Item names and functions of the browse screen	154
Playing back TV audio	155
Playback of TV audio with eARC/ARC	155
Playback of TV audio with a digital optical cable	156

Listening to the radio	157
Preparing to listen to the radio	157
Listening to the radio	160
Displaying the Radio Data System information	161
Displaying the DAB information	162
Registering a radio station manually	163
Registering FM radio stations automatically (Auto Preset)	164
Clearing preset stations	165
Playing back music with the Bluetooth® connection	166
Playback of Bluetooth® device music on the unit	166
Playback of music using Bluetooth® speakers/headphones	167
Playing back music with AirPlay	168
Playback of music with AirPlay	168
Playing back music stored on a USB flash drive	169
Playback of USB flash drive content	169
Playing back music stored on media servers (PCs/NAS)	171
Playback of music media servers (PCs/NAS)	171
Listening to Internet radio	172
Selecting an Internet radio station	172
Listening to music streaming services	173
Listening to a music streaming service	173

USEFUL FUNCTIONS **174**

Sleep timer function	174
Setting the time of the sleep timer	174
SCENE function	175
Selecting the input source and favorite settings with one touch (SCENE)	175
Selecting a registered scene	176
Registering a scene	178
Shortcut function	179
Registering a favorite content as shortcut	179
Recalling a registered content as shortcut	180

ENJOYING IN MULTIPLE ROOMS (ZONES) 181

Preparing zones	181
Playback in multiple rooms (multi zone function)	181
Multi-zone configuration examples	182
Connecting zone speakers	184
Connecting an HDMI device in zone	186
Operating zones	187
Turning on/off the power of zones	187
Basic procedure in zone	188
Other procedure in zone	189
Enjoying the same source in multiple rooms (party mode)	190

CONFIGURATIONS 191

Configuring the unit	191
Using the menu	191
Configuring playback settings for different playback sources (Option menu)	192
Basic operation of the Option menu	192
Option menu items	193
Adjusting the tone of the audio output	194
Configuring the volume automatically based on the YPAO measurement results	195
Adjusting the dialogue sounds	197
Adjusting the delay of the Lipsync function	200
Setting Compressed Music Enhancer	201
Setting the high-resolution mode	202
Correcting volume differences during playback	203
Setting the use of Extra Bass	205
Enabling the video signal processing	206
Selecting the video adjustment setting	207
Selecting a video source to be displayed with the selected audio source	208
Configuring the shuffle/repeat setting	209
Adding a “NET RADIO” radio station to the “Favorites” folder	211
Removing a radio station from the “Favorites” folder	212
Checking the current status information	213

Configuring various functions (Setup menu)	214
Basic operation of the Setup menu	214
Setup menu items	216
Configuring the speaker settings	224
Configuring the sound settings	242
Configuring the scene settings	268
Configuring the video/HDMI settings	270
Configuring the network settings	284
Configuring the Bluetooth® settings	293
Configuring the multi zone settings	299
Configuring the system settings	311
Configuring the unit's settings by operation of the body front panel (Front Display menu)	339
Basic operation of the Front Display menu	339
Front Display menu items	340
Adjusting the brightness of the front display	341
Setting the power of each zone to on/standby	342
Setting the use of the volume on the front panel	343
Setting the use of the input selector on the front panel	344
Setting the use of the scene key on the front panel	345
Setting the use of the operation sound	346
Setting the use of the remote control	347
Selecting the remote control ID	348
Setting information items to be skipped when operating SELECT/ENTER	349
Restoring the default settings	350
Backing up and restoring all the settings	351
Updating the firmware	352
Setting the use of Retail Demo Mode	353
UPDATE	354
Updating the unit's firmware	354
Firmware updates	354
Updating the unit's firmware via the network	355
Updating the unit's firmware using a USB flash drive	357

TROUBLESHOOTING**358**

When any problem appears	358
If trouble occurs, first check the following:	358
Power, system, or remote control trouble	359
Audio trouble	369
Video trouble	380
FM/AM radio trouble	385
DAB radio trouble	390
USB trouble	395
Network trouble	399
Bluetooth® trouble	410
Error indications on the front display	412
Error indications on the front display	412

APPENDIX**413**

Care and cleaning	413
Care for the front panel	413
Connecting to a network wirelessly	414
Selecting a wireless network connection method	414
Setting up a wireless connection using the WPS button	415
Setting up a wireless connection using an iPhone	416
Setting up a wireless connection by selecting from the list of available access points	417
Setting up a wireless connection manually	418
Setting up a wireless connection using the WPS PIN code	419
Using presence speakers	420
Presence speaker layout	420
Installing the presence speakers in Front Height/Rear Height position	421
Installing the presence speakers in Overhead position	422
Using Dolby Enabled speakers as the presence speakers	424
Supported devices and file formats	425
Supported Bluetooth® devices	425
Supported USB devices	426
Supported file formats	427
Zone output	428
Multi-zone output	428
Video signal flow	429
Video signal flow	429
Video conversion table	430

CONTENTS

Trademarks	431
Trademarks	431
Specifications	434
Specifications	434
Default settings	442
Default settings of the Option menu	442
Default settings of the Setup menu	443
Default settings of the Front Display menu	449

BEFORE USING THE UNIT

Read me first

How to use this guide

Thank you very much for purchasing a Yamaha product.

- This unit is a product for enjoying video and music at home.
- This guide explains preparations and operations for everyday users of the unit.
- To use the unit safely and correctly, be sure to read this guide carefully before using it.

When reading this guide, mind the following items.

- The illustrations of the main unit used in this guide are of the U.S.A. model, unless otherwise specified.
- This guide mainly explains operations using the menu displayed on the TV.
- This guide explains operations using the supplied remote control.
- This guide describes all the “iPod touch”, “iPhone” and “iPad” as the “iPhone”. “iPhone” refers to “iPod touch”, “iPhone” and “iPad”, unless otherwise specified.
- Symbols and signal words in this guide



CAUTION:

Indicates precautions for the possibility of minor or moderate injury.

NOTICE:

Indicates precautions for use to avoid the possibility of malfunction/damage to the unit and unit's data loss.

NOTE:

Indicates instructions and supplementary explanations for optimum use.

[Search tag]:

Indicates a keyword used in searches. This serves as a link from “Quick Start Guide” to “User Guide” and so on.

NOTE

Read “Safety Brochure” and “Quick Start Guide” first.

Glossary

For a glossary of terms used in this guide, refer to the site below. There are explanations of terms and technologies for this product and also for Yamaha AV products in general.

<https://manual.yamaha.com/av/cm/glossary/>

Checking the accessories

Checking the accessories

Check that the following accessories are supplied with the product.

- AM antenna (Except for U.K., Europe, Russia and Australia models)



- FM antenna (Except for U.K., Europe, Russia and Australia models)

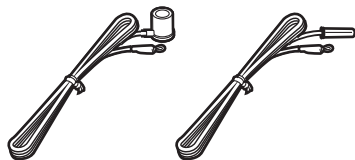

* One of the above is supplied depending on the region of purchase.

- DAB/FM antenna (U.K., Europe, Russia and Australia models)



- Power cable



* The supplied power cable varies depending on the region of purchase.

- YPAO microphone



- Microphone base and Pole

BEFORE USING THE UNIT > Checking the accessories

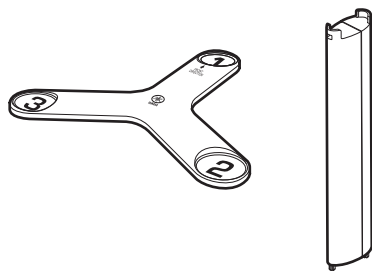

* The microphone base and pole are used for angle/height measurement during YPAO.

- Remote control
- Batteries (AAA, LR03, UM-4) (x2)
- Quick Start Guide
- Safety Brochure

NOTE

Access the Yamaha Downloads site to download the latest Quick Start Guide.
<http://download.yamaha.com/>

Using the remote control

Insert the batteries in the remote control

Insert the batteries the right way round.

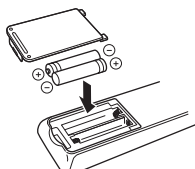

Operating range of the remote control

The operating range of the remote control is shown in the following figure.

Point the remote control at the remote control sensor on the unit.

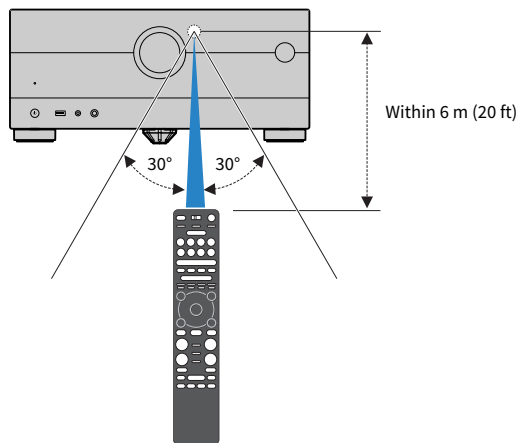

FEATURES

What you can do with the unit

Supporting various speaker system

According to the number of speakers that you are using, you can enjoy your favorite acoustic spaces in various styles.

- 7.2.2/5.2.4-channel system
- 5.2.4-channel system
- 7.2.2-channel system
- 5.1.2-channel system
- 7.1-channel system
- 5.1-channel system
- 3.1.2-channel system
- 3.1-channel system
- 2.1-channel system
- Virtual CINEMA FRONT
- Multi zone function
- Bi-amp connection

Related links

- “Speaker systems recommended to the unit (basic setup)” (p.41)
- “Other speaker systems (basic setup)” (p.43)
- “Speaker systems using the unit’s internal amplifier (advanced setup)” (p.60)
- “Speaker systems using an external power amplifier (advanced setup)” (p.73)

Automatically optimizing the speaker settings

YPAO function detects speaker connections, measures the distances from them to your listening positions (measuring positions) by using YPAO microphone measurement, and then automatically optimizes the speaker settings, such as volume balance and acoustic parameters, to suit your room (YPAO: Yamaha Parametric room Acoustic Optimizer).

- “Flow of the speaker configurations” (p.115)

Enjoying sound field effects with much presence

The unit is equipped with a variety of sound programs and surround decoders that allow you to enjoy playback sources with your favorite sound mode (such as sound field effect or stereo playback).

- “Enjoying 3-dimensional sound fields” (p.133)
- “Enjoying sound field effects optimized for the type of content” (p.134)
- “Enjoying sound field effects without surround speakers (Virtual CINEMA DSP)” (p.137)
- “Enjoying surround sound with headphones (SILENT CINEMA)” (p.139)
- “Enjoying original sound (straight decode)” (p.140)
- “Enjoying multichannel playback without sound field effects (surround decoder)” (p.141)
- “Enjoying higher quality playback (Pure Direct)” (p.142)
- “Enjoying bass sound with small speakers (Extra Bass)” (p.149)
- “Enjoying more powerful sound to the audio source (Compressed Music Enhancer)” (p.145)
- “Enjoying Dolby Atmos® and DTS:X™” (p.143)
- “Enjoying AURO-3D®” (p.144)

Wide variety of supported content via network

When the unit is connected to a network, you can enjoy the various kinds of content via network on the unit.

- “Playback of music with AirPlay” (p.168)
- “Playback of music media servers (PCs/NAS)” (p.171)
- “Selecting an Internet radio station” (p.172)
- “Listening to a music streaming service” (p.173)

Playing back content of various devices

A number of HDMI jacks and various input/output jacks on the unit allow you to connect video devices (such as BD/DVD players), audio devices (such as CD players), Bluetooth devices (such as smartphones), game consoles, USB flash drives, and other devices. You can play back content of them or tune in to a radio station.

- “Listening to the radio” (p.160)
- “Playback of Bluetooth® device music on the unit” (p.166)
- “Playback of USB flash drive content” (p.169)

Useful functions

The unit is equipped with the various useful functions. The SCENE function allows you to select the input source and settings registered to the corresponding scene, such as sound program and Compressed Music Enhancer on/off, with just one touch. You can recall the registered content (such as music stored on media servers and Internet radio stations) by selecting the shortcut number. When the unit is connected to an HDMI Control-compatible TV with an HDMI cable, you can control the unit (such as power and volume) with TV remote control operations.

- “Selecting the input source and favorite settings with one touch (SCENE)” (p.175)
- “Registering a favorite content as shortcut” (p.179)
- “Playback of TV audio with eARC/ARC” (p.155)

Supporting wireless speakers

The unit is equipped with the function connected with speakers wirelessly. You can enjoy audio played back on the unit using Bluetooth speakers/headphones. Also, using devices that support the MusicCast Surround function, the surround speakers and subwoofer can be wireless.

- “Playback of music using Bluetooth® speakers/headphones” (p.167)
- “Configuring wireless speakers” (p.113)

Useful applications

AV SETUP GUIDE



AV SETUP GUIDE is an application that assists you with cable connections between AV Receiver and playback devices as well as AV Receiver setup. This app guides you through the various settings such as speaker connections, TV and playback device connections and selecting the speaker system.

For details, search for “AV SETUP GUIDE” on the App Store or Google Play.

MusicCast Controller



MusicCast Controller is an application that allows you to link a MusicCast compatible device to other MusicCast compatible devices in other rooms and play them back simultaneously. This app lets you use your smartphone or other mobile device instead of the remote control to easily select music to play back as well as configure the unit and MusicCast compatible devices.

For details, search for “MusicCast Controller” on the App Store or Google Play.

PART NAMES AND FUNCTIONS

Unit body

Part names and functions of the front panel

The part names and functions of the front panel are as follows.

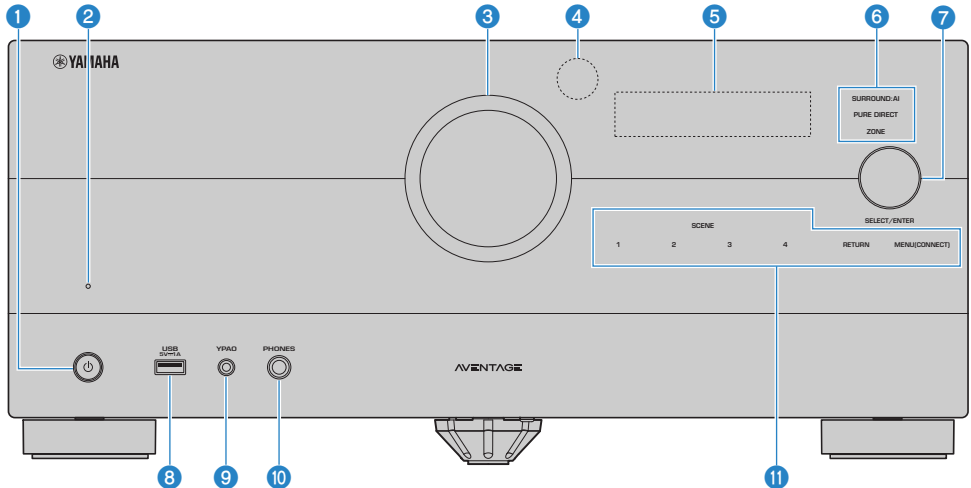

1  **(power)**

Turns on/off (standby) the Main zone (p.108).

2 **Standby indicator**

Lights up when the unit is in standby mode under any of the following conditions.

- HDMI Control is enabled (p.275)
- Standby Through is enabled (p.281)
- Network Standby is enabled (p.288)
- Bluetooth Standby is enabled (p.295)

3 **VOLUME**

Adjusts the volume.

4 **Remote control sensor**

Receives remote control signals (infrared) (p.15).

5 **Front display**

Displays information and menu (p.27).

NOTE

Under the high or low temperature, the visibility of the character is sometimes deteriorated by the LCD characteristics. It is not a malfunction.

6 Indicator

Lights up under the following condition.

SURROUND:AI

Lights up when the SURROUND:AI is working (p.132).

PURE DIRECT

Lights up when PURE DIRECT is working (p.142).

ZONE

Lights up when the zone output is enabled (p.187).

7 SELECT/ENTER

Selects the input source and operates the front display.

8 USB jack

For connecting a USB flash device (p.169).

9 YPAO jack

For connecting the supplied YPAO microphone (p.115).

10 PHONES jack

For connecting headphones.

11 Touch panel

For operation by a touch. The operation sound rings.

SCENE

Switches with one touch between multiple settings set using the SCENE function. Also, turns on the unit when it is in standby mode (p.175).

RETURN

Operates the “Front Display” menu.

MENU (CONNECT)

Operates the “Front Display” menu.

Enters the MusicCast network addition and the wireless LAN setup by holding down for 5 seconds.

Related links

“Care for the front panel” (p.413)

Front display

Part names and functions of the front display

The part names and functions of the front display are as follows.

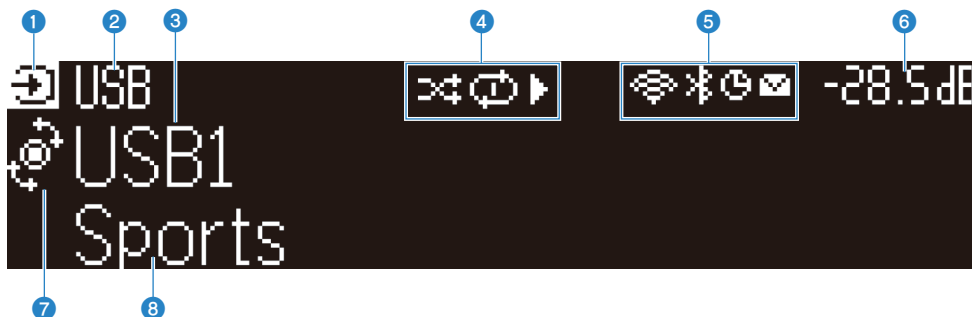

1 Operation mode icon

Indicates the current mode of the front display (the input select mode or the info select mode).

2 Input default name

Displays the default name when you have renamed the input source name.

3 Main information

Displays information, such as the current input name, input information item, according to the mode of the front display.

4 Play status icon

Shuffle

Lights up when the shuffle setting is turned on (p.209).

Repeat

Lights up when the repeat setting is turned on (p.210).

Playback/Pause/Stop

Lights up while the unit plays back a song, pauses or stops.

5 Status icon

Wireless LAN

Lights up while the unit is connected to a wireless network (p.414).

Bluetooth

Lights up while the unit is connected to a Bluetooth device (p.166).

Sleep timer

Lights up when the sleep timer is on (p.174).

Firmware update

Lights up when a firmware update is available via the network (p.354).

6 Volume

Indicates the current volume.

7 SELECT/ENTER indicator

Indicates the available SELECT/ENTER status (push or rotate) for the right display area.

8 Additional information

Displays the additional information of the current input such as Reception, DSP Program.

NOTE

- Depending on the content of playback, the unit may not get its playback status correctly. For details on the playback status, refer to the MusicCast Controller app or your playback software.
- If the unit is the slave device of the MusicCast network, the playback status is displayed as follows, depending on the master device.
 - Playback icon is lit up on the front display of the unit when the content of audio playback is selected as the input source of the master device, and the master device pauses.
 - Playback icon is always lit up on the front display of the unit when “HDMI”, “AV”, “AUDIO”, “PHONO”, “TV” or “TUNER” is selected as the input source of the master device.

Selecting the input information displayed on the front display

The front display in the info select mode displays additional information related to the input source on the front display.



Push SELECT/ENTER on the front panel to switch the front display to the info select mode. And rotate SELECT/ENTER to select between the various items. The additional information is displayed under the item.

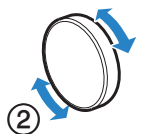
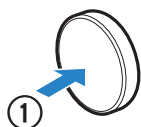

Displayed items vary depending on the input source.

Currently input source	Displayed item
HDMI	
AV	
AUDIO	DSP Program, Audio Decoder, Output Channel, HDMI Status, Zone Status, System Status
PHONO	
TV	
TUNER (FM/AM)	Reception, DSP Program, Audio Decoder, Output Channel, HDMI Status, Zone Status, System Status (U.K., Europe and Russia models only) Radio Data System data is also available when the unit is tuned into a Radio Data System broadcasting station. For details, see the following: <ul style="list-style-type: none"> • “Displaying the Radio Data System information” (p.161)
TUNER (DAB)	(U.K., Europe, Russia and Australia models only) For details, see the following: <ul style="list-style-type: none"> • “Displaying the DAB information” (p.162)
SERVER	Song, Artist, Album, IP Address, Ethernet MAC Address, Wi-Fi MAC Address, DSP Program, Audio Decoder, Output Channel, HDMI Status, Zone Status, System Status
NET RADIO	Station, IP Address, Ethernet MAC Address, Wi-Fi MAC Address, DSP Program, Audio Decoder, Output Channel, HDMI Status, Zone Status, System Status, Song, Album
Spotify	Track, Artist, Album, IP Address, Ethernet MAC Address, Wi-Fi MAC Address, DSP
Deezer	Program, Audio Decoder, Output Channel, HDMI Status, Zone Status, System Status

Currently input source	Displayed item
music streaming services (with playback information) AirPlay	Song, Artist, Album, IP Address, Ethernet MAC Address, Wi-Fi MAC Address, DSP Program, Audio Decoder, Output Channel, HDMI Status, Zone Status, System Status
music streaming services (without playback information) Alexa MusicCast Link	DSP Program, Audio Decoder, Output Channel, HDMI Status, Zone Status, System Status, IP Address, Ethernet MAC Address, Wi-Fi MAC Address
Bluetooth USB	Song, Artist, Album, DSP Program, Audio Decoder, Output Channel, HDMI Status, Zone Status, System Status

NOTE

- You can set “Information Skip” in the “Front Display” menu to skip information items on the front display.
- When you have not operated SELECT/ENTER for a few seconds, the front display turns to the input select mode automatically.

Related links

“Setting information items to be skipped when operating SELECT/ENTER” (p.349)

■ Output Channel

Information about output channels (speaker terminals and PRE OUT jacks) that are currently outputting sound is displayed. No output is indicated by an underscore.



Indicators

■ HDMI Status

Information about the HDMI input jacks (connection) and the HDMI out jack (connection, destination) is displayed. No connection is indicated by an underscore.

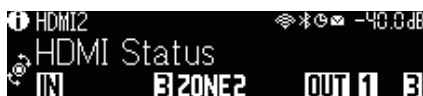
**■ Zone Status**

Information about the zone number or letter that is currently enabled is displayed. The disabled zone is indicated by an underscore.

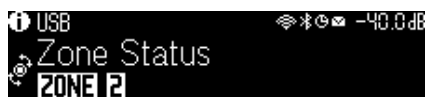

■ System Status

The following system information is displayed. An underscore is indicated when it is disabled.

- ECO: the eco mode is enabled.
- PARTY: the party mode is enabled.
- MASTER: the unit is the master device of the MusicCast network.



Part names and functions of the rear panel

The part names and functions of the rear panel are as follows.

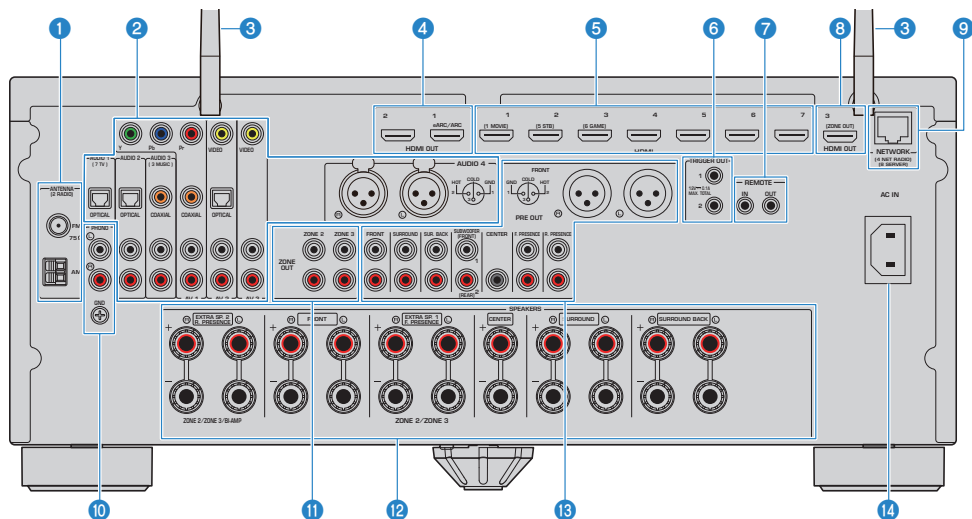

- The area around the video/audio output jacks is marked in white on the actual product to prevent improper connections.

1 ANTENNA jacks

For connecting to the radio antennas (p.97).

2 AUDIO 1-4 jacks, AV 1-3 jacks

For connecting to video/audio playback devices and inputting video/audio signals (p.93).

3 Wireless antennas

For a wireless (Wi-Fi) connection to a network (p.101) and a Bluetooth connection (p.166).

4 HDMI OUT 1-2 jacks

For connecting to HDMI-compatible TV and outputting video/audio signals (p.89). When using eARC/ARC, TV audio signals are also input.

5 HDMI 1-7 jacks

For connecting to HDMI-compatible playback devices and inputting video/audio signals (p.92).

6 TRIGGER OUT 1-2 jacks

For connecting to devices that support the trigger function (p.104).

7 REMOTE IN/OUT jacks

For connecting to an infrared signal receiver/emitter that allows you to operate the unit and other devices from another room (p.105).

8 HDMI OUT 3 (ZONE OUT) jack

For connecting to an HDMI-compatible device used in Zone2 or Zone4 (p.186).

9 NETWORK jack

For a wired connection to a network (p.102).

10 PHONO jacks

For connecting to a turntable (p.95).

11 ZONE OUT jacks

For connecting to the external amplifier used in another room (Zone2 or Zone3) and for outputting audio (p.185).

12 SPEAKERS terminals

For connecting to speakers (p.37).

13 PRE OUT jacks

For connecting to a subwoofer with built-in amplifier (p.88) or to an external power amplifier (p.74).

14 AC IN jack

For connecting the supplied power cable (p.107).

Remote control

Part names and functions of the remote control

The part names and functions of the supplied remote control are as follows.

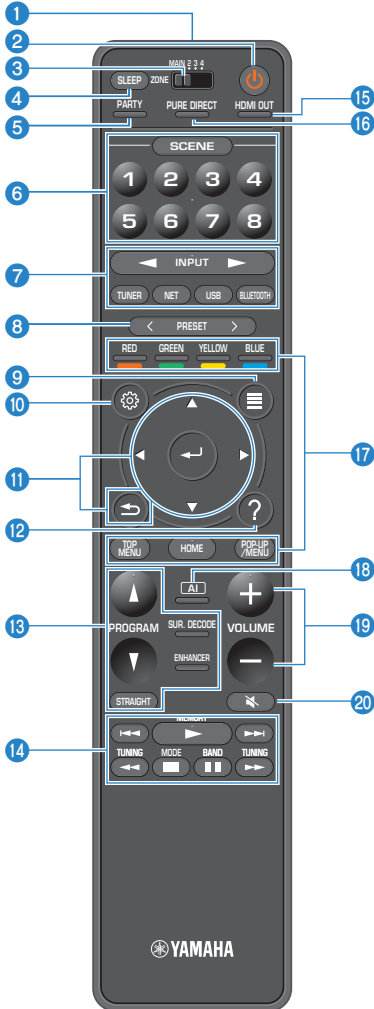

1 Remote control signal transmitter

Transmits remote control signals (infrared).

2  (power) key

Turns on/off the zone selected by zone switch (p.187).

3 Zone switch

Changes the zone that is controlled by the remote control (p.188).

4 SLEEP key

Sets the time of the sleep timer (p.174).

5 PARTY key

Turns on/off the party mode (p.190).

6 SCENE keys

Switches with one touch between multiple settings set using the SCENE function. Also, turn on the unit when it is in standby mode (p.175).

7 Input selection keys

Selects an input source for playback.

NOTE

Presses NET repeatedly to select a desired network source.

8 11 14 17 19 20 External device operation keys

Controls playback of the HDMI Control-compatible playback device.

NOTE

- The playback devices must support HDMI Control. Some HDMI Control-compatible devices cannot be used.
- You can set the function to use the color keys for other than the operation of devices connected to the unit with an HDMI cable (p.322).

8 PRESET keys

Selects a preset radio station (p.160).

Recalls Bluetooth, USB, or network content that is registered as a shortcut (p.180).

9 OPTION key

Displays the Option menu operated on the TV (p.192).

10 SETUP key

Displays the Setup menu operated on the TV (p.214).

11 ENTER/Cursor, RETURN keys

Operates the menu on the TV.

12 HELP key

In the on-screen menu, the description of a term in the cursor position appears on the TV. This key is enabled when the “?” icon is displayed on the on-screen menu.

13 Sound mode keys

Selects a sound program or a surround decoder (p.131).

NOTE

You can set the function to use the PROGRAM keys for other than the sound program selection (p.321).

14 Playback operation keys

Controls playback of the USB flash drive, music media server (PCs/NAS) or radio.

15 HDMI OUT key

Selects HDMI OUT jacks to be used for video/audio output (p.152).

16 PURE DIRECT key

Enables/disables the Pure Direct (p.142).

18 AI key

Turns on/off the SURROUND:AI mode (p.132).

19 VOLUME keys

Adjusts the volume.

20 MUTE key

Mutes the audio output.

PREPARATIONS

Before starting

Names and functions of speakers

The names and functions of speakers connected to the unit are as follows.

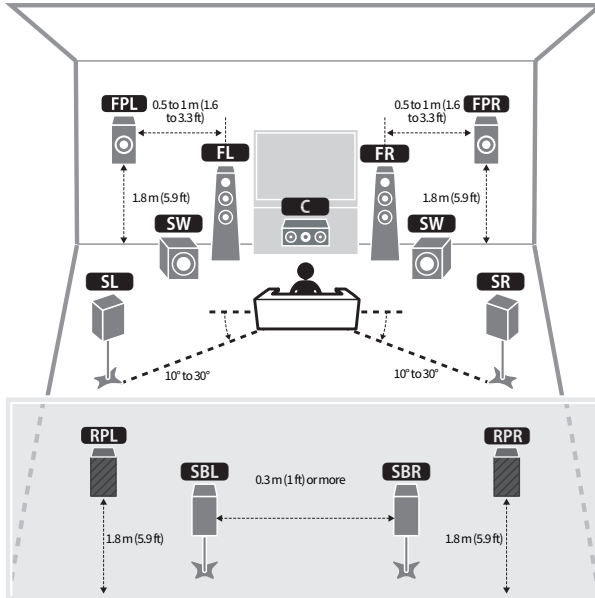

Speaker type	Abbr.	Function
Front	FL / FR	Produces front channel sounds (stereo sounds).
Center	C	Produces center channel sounds (such as movie dialogue and vocals).
Surround	SL / SR	Produces surround channel sounds.
Surround back	SBL / SBR	Produces surround back channel sounds.
Front presence	FPL / FPR	Produces CINEMA DSP HD ³ effect sounds or heights channel sounds.
Rear presence	RPL / RPR	Produces CINEMA DSP HD ³ effect sounds or heights channel sounds.
Subwoofer	SW	Produces LFE (low-frequency effect) channel sounds and reinforces the bass parts of other channels.

NOTE

- Use this diagram as a reference for the ideal speaker layout for the unit. However, your speaker layout does not need to match the diagram exactly. The automatic speaker setting (YPAO) can be used to automatically optimize the speaker settings (such as distances) to suit the actual speaker layout.
- The unit provides three layout patterns for front/rear presence speakers respectively. You can choose a layout pattern that suits your listening environment. You can enjoy Dolby Atmos, DTS:X, AURO-3D or CINEMA DSP HD³ with any layout pattern.

Related links

- “Flow of preparations (with surround speakers connected by speaker cables)” (p.39)
- “Flow of preparations (with surround speakers wirelessly connected)” (p.40)
- “Presence speaker layout” (p.420)

Flow of preparations

Flow of preparations (with surround speakers connected by speaker cables)

Basic flow of preparations for using the unit is as follows.

- 1 Place speakers.**
- 2 Connect speakers.**
- 3 Connect a TV.**
- 4 Connect playback devices.**
- 5 Connect the radio antennas.**
- 6 Prepare for connecting to a network.**
- 7 Set MusicCast network.**
- 8 Assign speaker configuration.**
- 9 Configure the speaker settings.**

Related links

“How to place speakers (speaker systems)” (p.41)

Flow of preparations (with surround speakers wirelessly connected)

Basic flow of preparations for using the unit with surround speakers wirelessly connected is as follows.

- 1 Place speakers.**
- 2 Connect speakers.**
- 3 Connect a TV.**
- 4 Connect playback devices.**
- 5 Connect the radio antennas.**
- 6 Prepare for connecting to a network.**
- 7 Set MusicCast network.**
- 8 Connect wireless speakers.**
- 9 Assign speaker configuration.**
- 10 Configure the speaker settings.**

Related links

“How to place speakers (speaker systems)” (p.41)

How to place speakers (speaker systems)

Speaker systems recommended to the unit (basic setup)

This speaker system brings out the full performance of the unit.

You can enjoy a highly-natural 3-dimensional sound field with any content. We recommend this speaker system for Dolby Atmos, DTS:X or AURO-3D content.

[Search tag]#Q01 Speaker systems

7.2.2/5.2.4-channel system

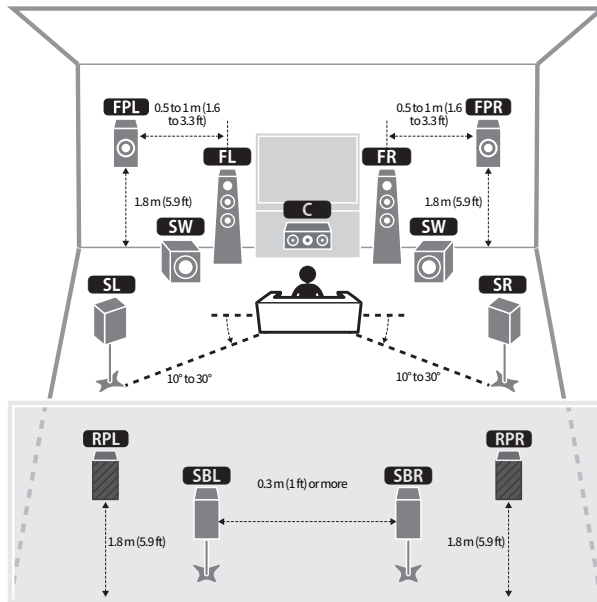

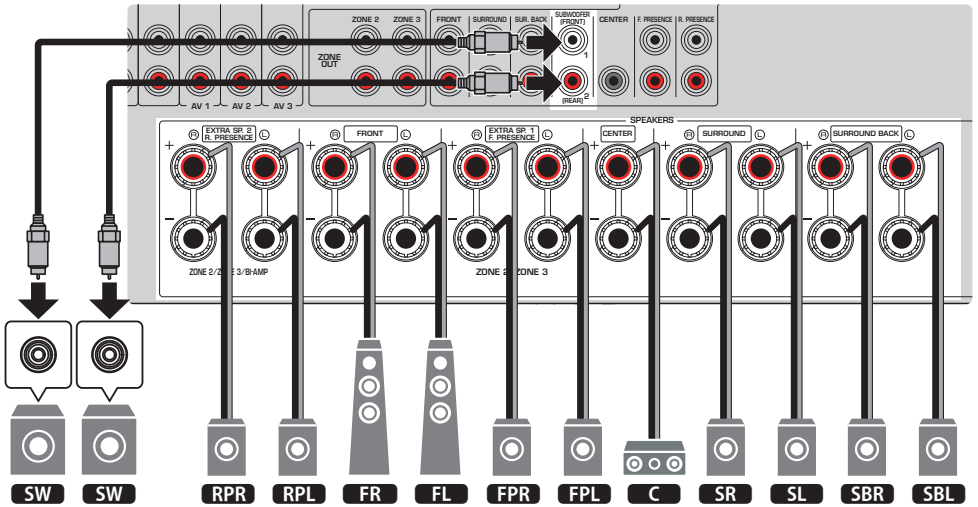

NOTE

- The surround back speakers and rear presence speakers do not produce sounds simultaneously. The unit automatically changes the speakers to be used, depending on the input signal and CINEMA DSP HD³.
- When installing the front/rear presence speakers on the ceiling above the listening position, or when using Dolby Enabled speakers as the front/rear presence speakers, the front/rear presence speaker layout settings must be changed.
- You can also connect up to 2 subwoofers (with built-in amplifier) to the unit. Two subwoofers connected to the unit output the separate sounds, and so you can place them on the left/right or front/rear sides of the room. In this case, their layout settings must be changed.
- When using only one subwoofer, you can place it either in the left or right side.

Related links

- “Speaker requirements” (p.84)
- “Setting the layout of the front presence speakers” (p.229)
- “Setting the layout of the rear presence speakers” (p.230)
- “Setting the layout of the subwoofers” (p.234)

7.2.2-channel system

To have a full effect of Dolby Atmos, DTS:X or AURO-3D content, we recommend this speaker system. This speaker system uses the front presence speakers to produce a natural 3-dimensional sound field, and also allows you to enjoy extended surround sounds using the surround back speakers.

[Search tag]#Q01 Speaker systems

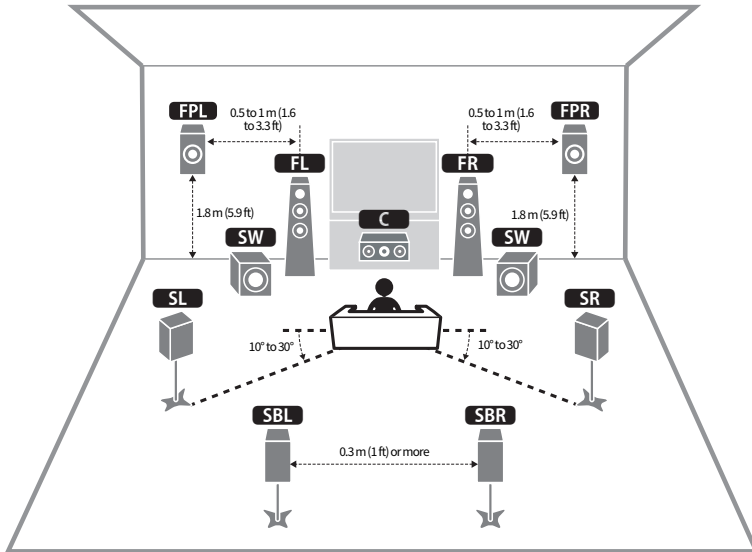

NOTE

- When installing the front presence speakers on the ceiling above the listening position, or when using Dolby Enabled speakers as the front presence speakers, the front presence speaker layout settings must be changed.
- You can also connect up to 2 subwoofers (with built-in amplifier) to the unit. Two subwoofers connected to the unit output the separate sounds, and so you can place them on the left/right or front/rear sides of the room. In this case, their layout settings must be changed.
- When using only one subwoofer, you can place it either in the left or right side.

Related links

- “Speaker requirements” (p.84)
- “Setting the layout of the front presence speakers” (p.229)
- “Setting the layout of the subwoofers” (p.234)

5.1.2-channel system

To have a full effect of Dolby Atmos, DTS:X or AURO-3D content, we recommend this speaker system. The front presence speakers produce a natural 3-dimensional surround field including overhead.

[Search tag]#Q01 Speaker systems

■ For layout with front presence speakers in Front Height position

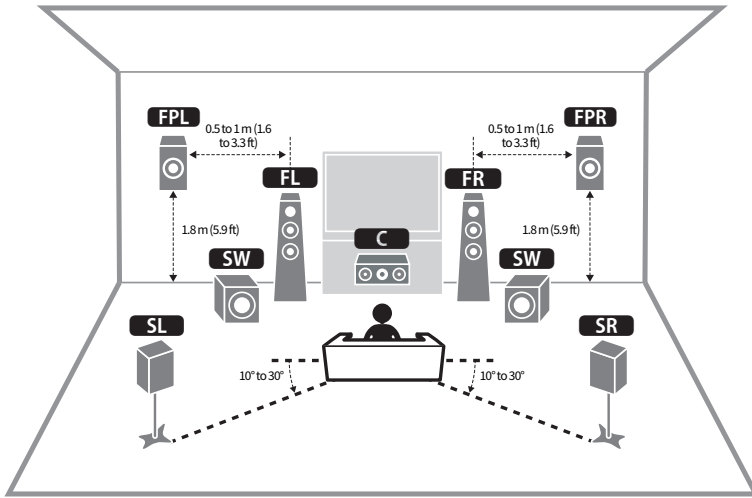

■ For layout with front presence speakers in Overhead position

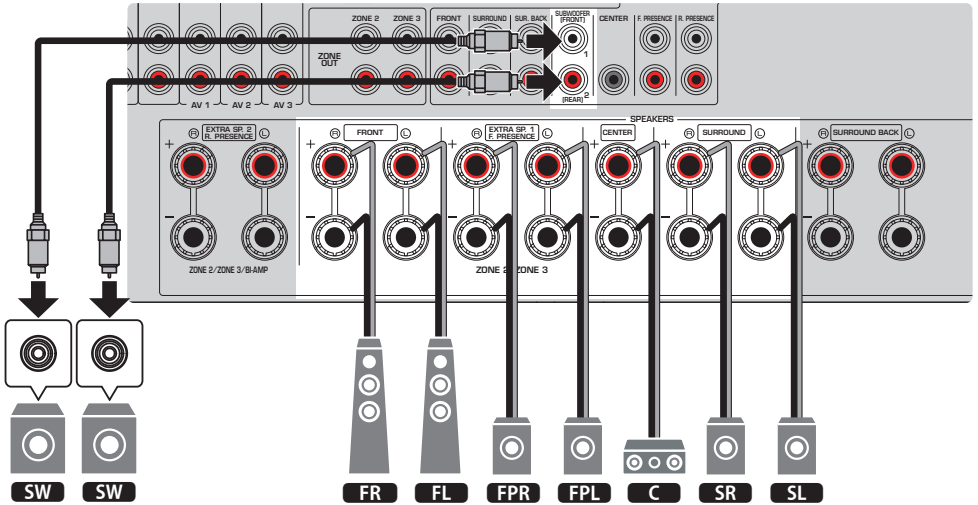
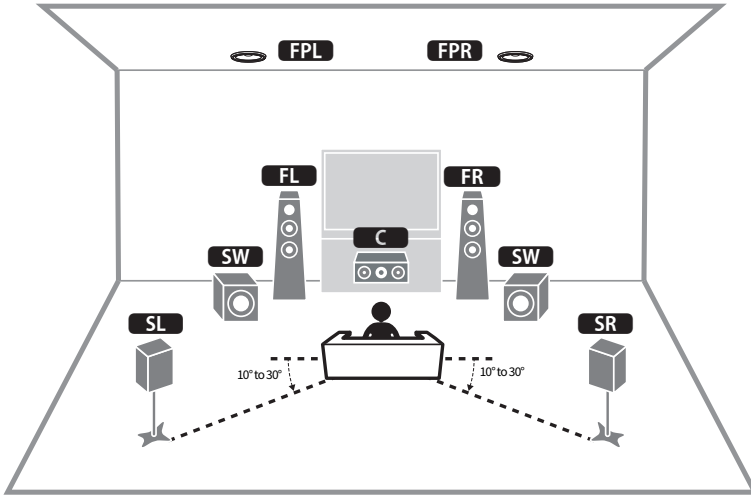

PREPARATIONS > How to place speakers (speaker systems)

NOTE

- When installing the front presence speakers on the ceiling above the listening position, or when using Dolby Enabled speakers as the front presence speakers, the front presence speaker layout settings must be changed.
- You can also connect up to 2 subwoofers (with built-in amplifier) to the unit. Two subwoofers connected to the unit output the separate sounds, and so you can place them on the left/right or front/rear sides of the room. In this case, their layout settings must be changed.
- When using only one subwoofer, you can place it either in the left or right side.

Related links

- “Speaker requirements” (p.84)
- “Setting the layout of the front presence speakers” (p.229)
- “Setting the layout of the subwoofers” (p.234)

7.1-channel system

This speaker system allows you to enjoy extended surround sound using the surround back speakers.

[Search tag]#Q01 Speaker systems

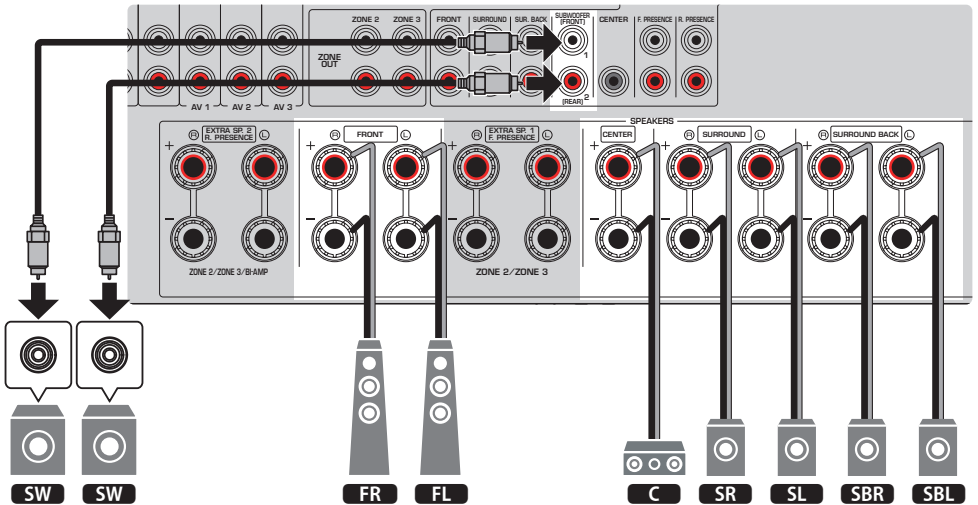
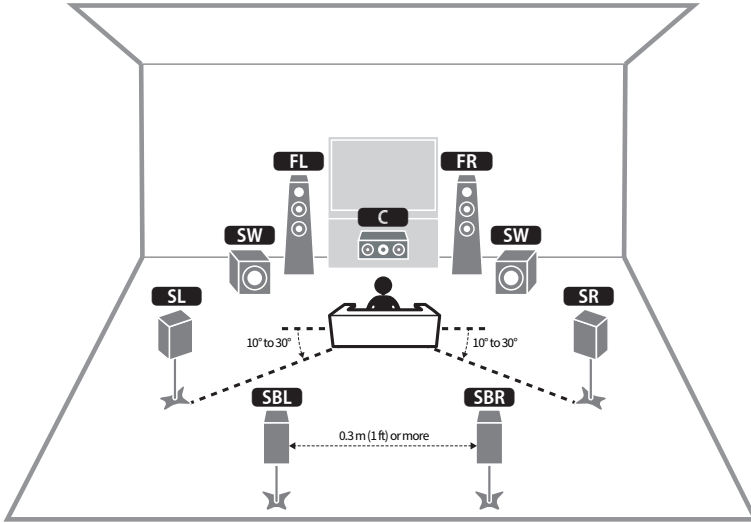

PREPARATIONS > How to place speakers (speaker systems)

NOTE

- You can also connect up to 2 subwoofers (with built-in amplifier) to the unit. Two subwoofers connected to the unit output the separate sounds, and so you can place them on the left/right or front/rear sides of the room. In this case, their layout settings must be changed.
- When using only one subwoofer, you can place it either in the left or right side.

Related links

- “Speaker requirements” (p.84)
- “Setting the layout of the subwoofers” (p.234)

5.1-channel system

This is a basic speaker layout recommended for enjoying surround sound.

[Search tag]#Q01 Speaker systems

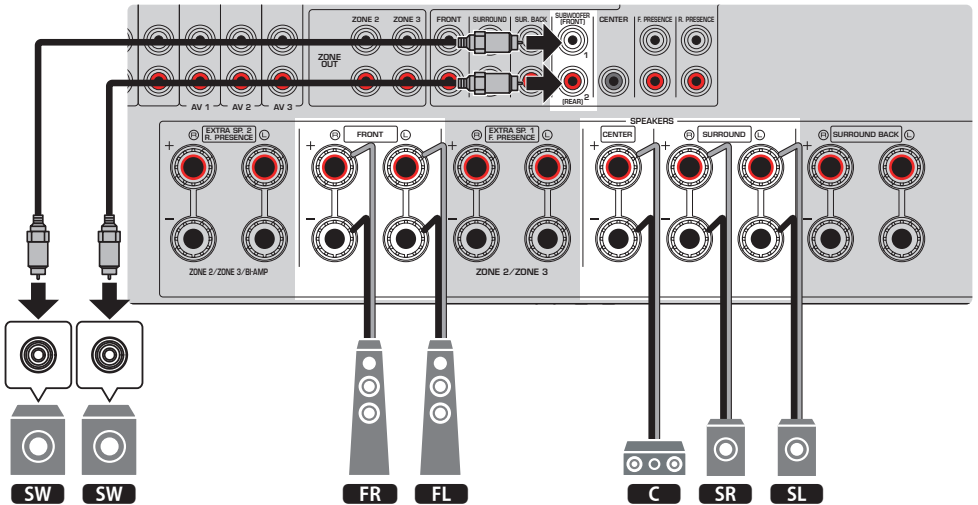
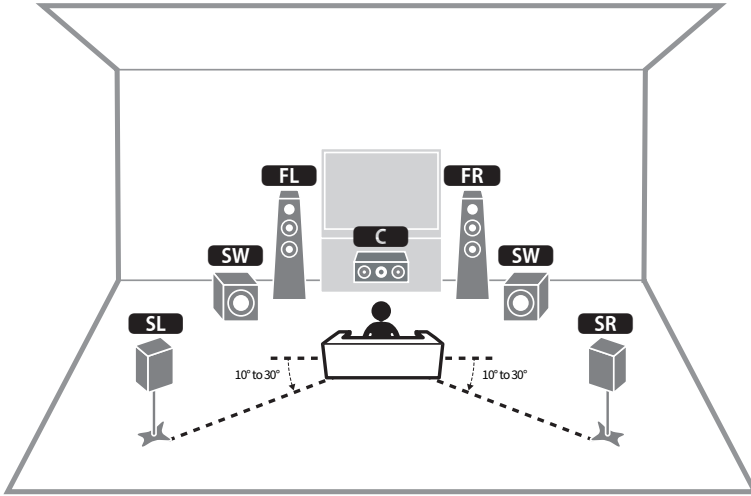

PREPARATIONS > How to place speakers (speaker systems)

NOTE

- You can also connect up to 2 subwoofers (with built-in amplifier) to the unit. Two subwoofers connected to the unit output the separate sounds, and so you can place them on the left/right or front/rear sides of the room. In this case, their layout settings must be changed.
- When using only one subwoofer, you can place it either in the left or right side.

Related links

- “Speaker requirements” (p.84)
- “Setting the layout of the subwoofers” (p.234)

3.1.2-channel system

We recommend this speaker layout when you cannot place speakers in the back of the room. You can also enjoy Dolby Atmos, DTS:X or AURO-3D content with this speaker system.

[Search tag]#Q01 Speaker systems

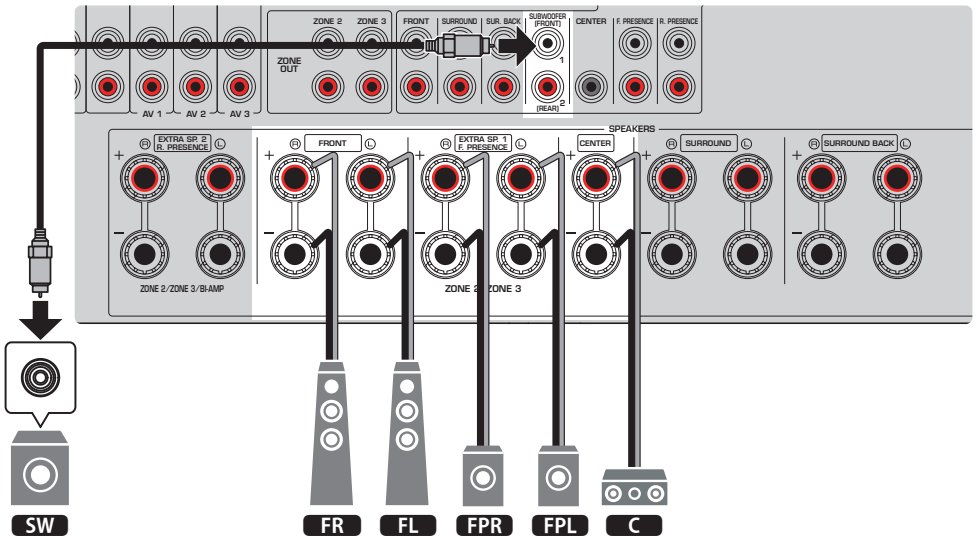
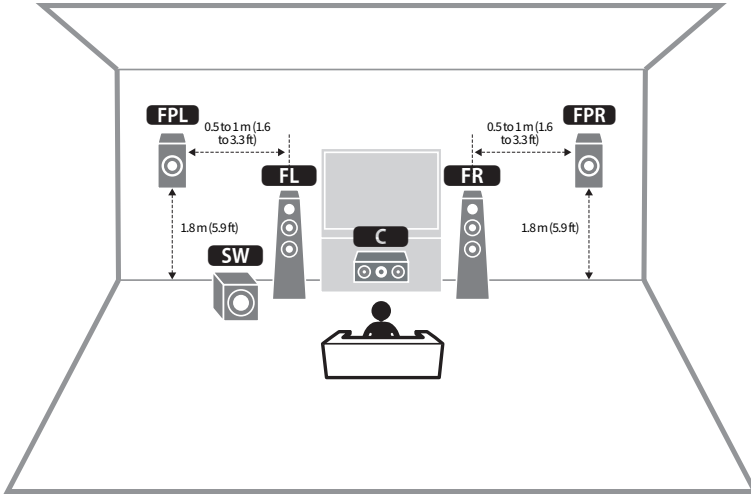

PREPARATIONS > How to place speakers (speaker systems)

NOTE

- When installing the front presence speakers to the ceiling above the listening position or using the Dolby Enabled speakers as the front presence speakers, configure your front presence speaker layout.
- You can also connect up to 2 subwoofers (with built-in amplifier) to the unit. Two subwoofers connected to the unit output the separate sounds, and so you can place them on the left/right or front/rear sides of the room. In this case, their layout settings must be changed.
- When using only one subwoofer, you can place it either in the left or right side.

Related links

- “Speaker requirements” (p.84)
- “Setting the layout of the front presence speakers” (p.229)
- “Setting the layout of the subwoofers” (p.234)

3.1-channel system

This is a speaker layout recommended for enjoying stereo sound with a center speaker. Center channel sound such as movie dialogue and vocals can be clearly obtained.

[Search tag]#Q01 Speaker systems

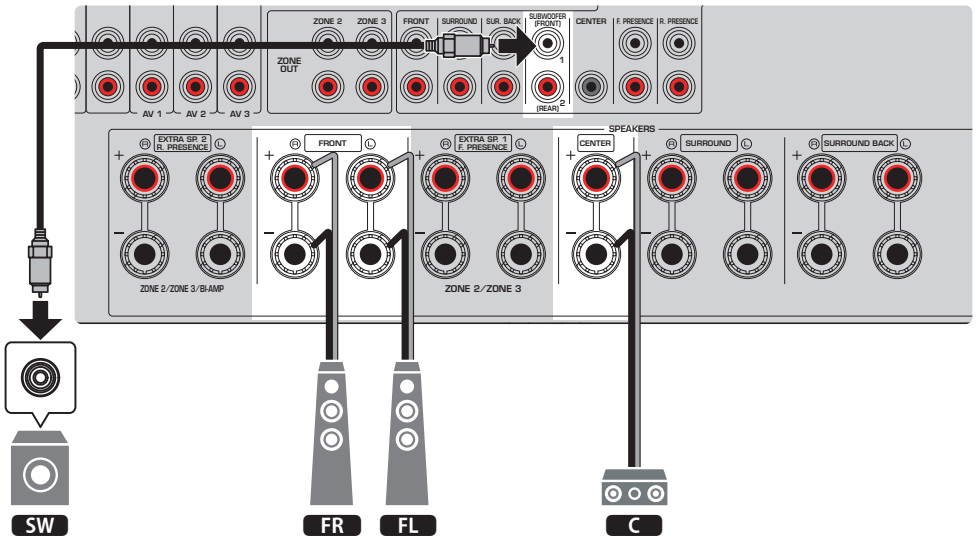
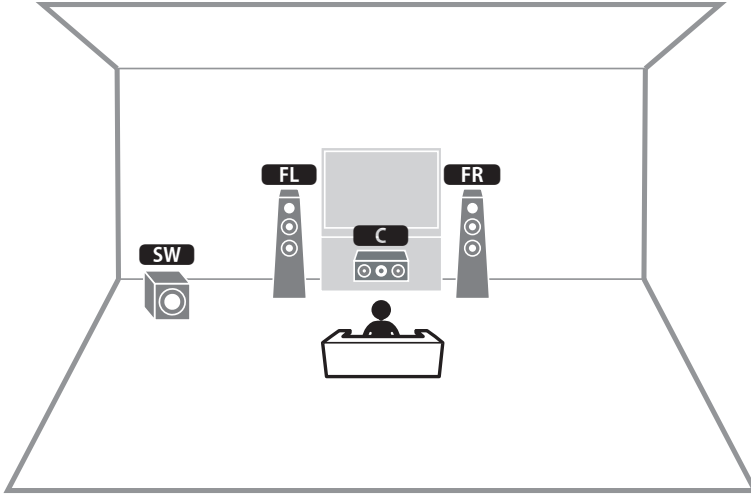

PREPARATIONS > How to place speakers (speaker systems)

NOTE

- You can also connect up to 2 subwoofers (with built-in amplifier) to the unit. Two subwoofers connected to the unit output the separate sounds, and so you can place them on the left/right or front/rear sides of the room. In this case, their layout settings must be changed.
- When using only one subwoofer, you can place it either in the left or right side.

Related links

- “Speaker requirements” (p.84)
- “Setting the layout of the subwoofers” (p.234)

2.1-channel system

This is a speaker layout recommended for enjoying stereo sound.

[Search tag]#Q01 Speaker systems

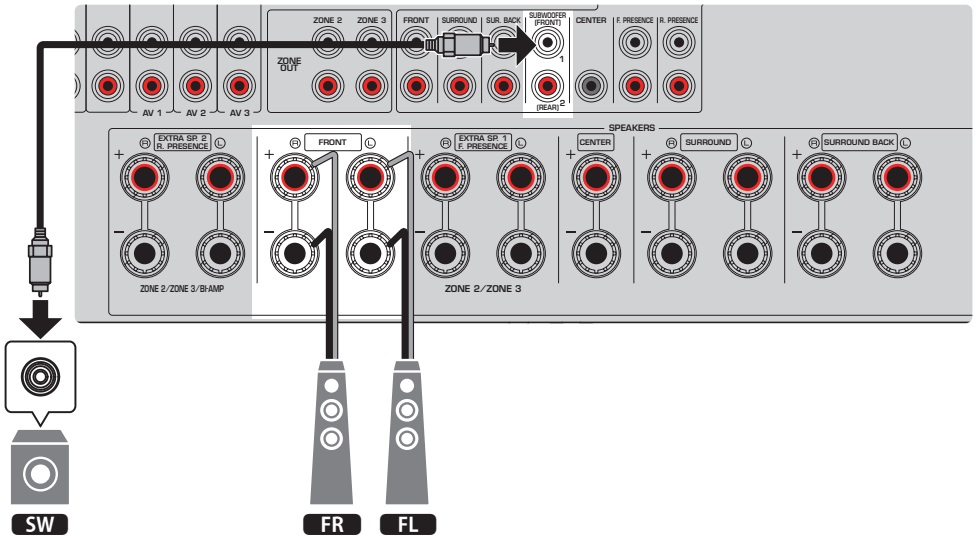
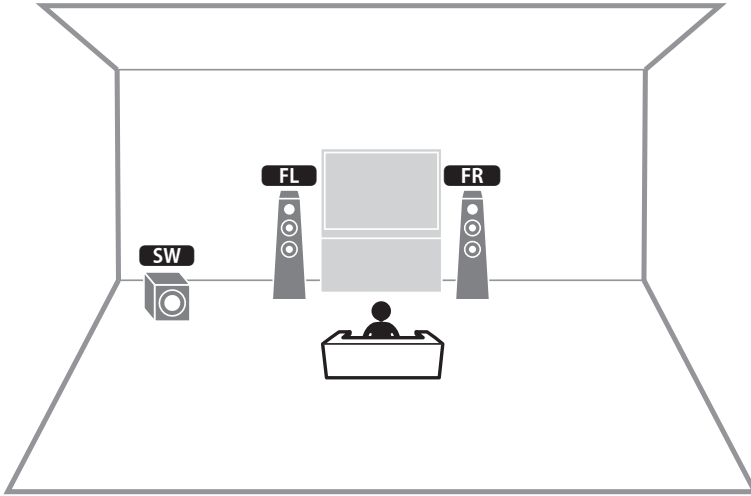

PREPARATIONS > How to place speakers (speaker systems)

NOTE

- You can also connect up to 2 subwoofers (with built-in amplifier) to the unit. Two subwoofers connected to the unit output the separate sounds, and so you can place them on the left/right or front/rear sides of the room. In this case, their layout settings must be changed.
- When using only one subwoofer, you can place it either in the left or right side.

Related links

- “Speaker requirements” (p.84)
- “Setting the layout of the subwoofers” (p.234)

Virtual CINEMA FRONT

This speaker layout is recommended if you cannot place speakers in the back of the room.

[Search tag]#Q01 Speaker systems

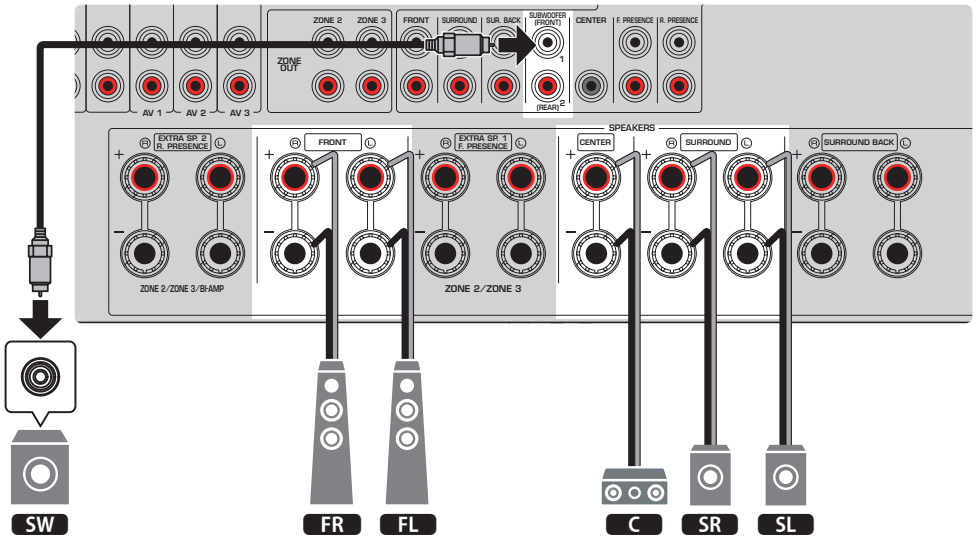
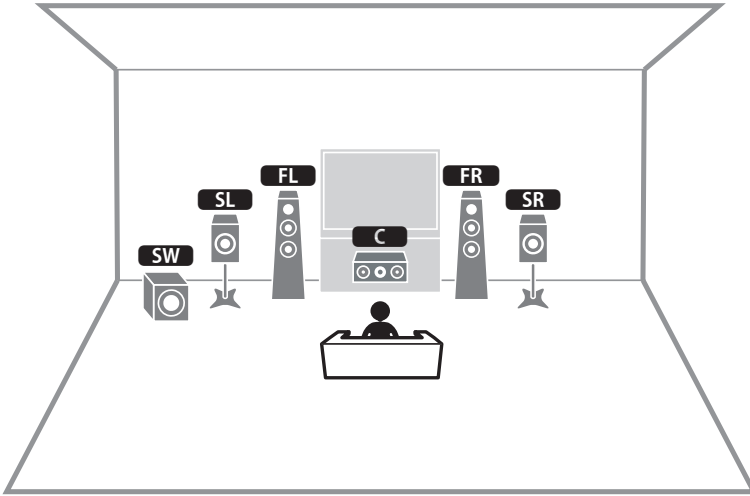

PREPARATIONS > How to place speakers (speaker systems)

NOTE

- To use Virtual CINEMA FRONT, the speaker configuration settings must be changed.
- You can also connect up to 2 subwoofers (with built-in amplifier) to the unit. Two subwoofers connected to the unit output the separate sounds, and so you can place them on the left/right or front/rear sides of the room. In this case, their layout settings must be changed.
- When using only one subwoofer, you can place it either in the left or right side.

Related links

- “Setting your speaker system” (p.226)
- “Setting the layout of the surround speakers” (p.228)
- “Speaker requirements” (p.84)
- “Setting the layout of the subwoofers” (p.234)

Speaker systems using the unit's internal amplifier (advanced setup)

List of speaker systems using the unit's internal amplifier

In addition to the basic speaker systems, the unit also allows you to apply the following speaker configurations.

To enjoy following systems, configure the necessary speaker settings in "Power Amp Assign" in the "Setup" menu.

[Search tag]#Q01 Speaker systems

Main zone			Multi-zone	Power Amp Assign	Page
Output channel (max)	Bi-amp	Surround back/Presence			
7		Surround back	+1 room	7.2 +1Zone	p.61
9		Surround back Front presence	+1 room	7.2.2 +1Zone	p.63
7		Surround back	+2 rooms	7.2 +2Zone	p.65
7	○	Surround back		7.2 Bi-Amp	p.67
7	○	Front presence		5.2.2 Bi-Amp	p.69
7	○	Surround back	+1 room	7.2 Bi-Amp +1Zone	p.71

Related links

- "Speaker requirements" (p.84)
- "Setting your speaker system" (p.226)
- "Multi-zone configuration examples" (p.182)

7.2 +1Zone

The Zone function allows you to play back an input source in the room where the unit is installed and in another room.

[Search tag]#Q01 Speaker systems

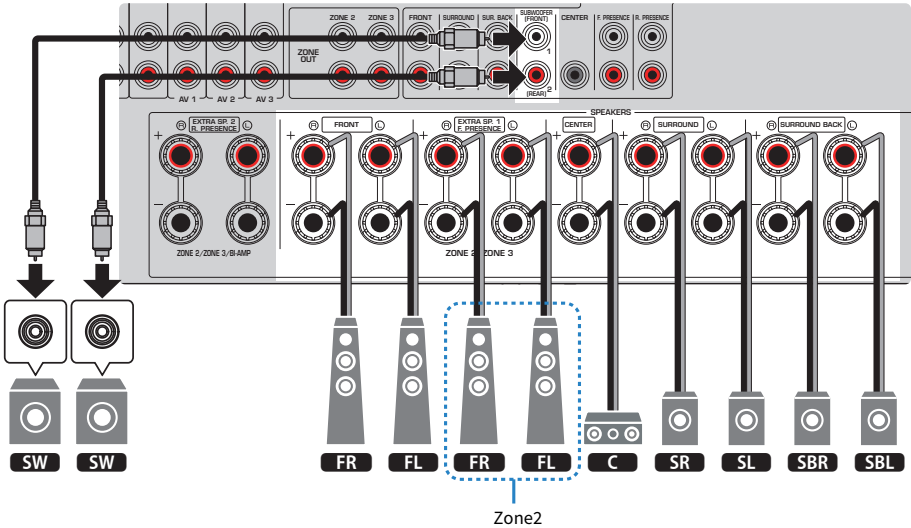
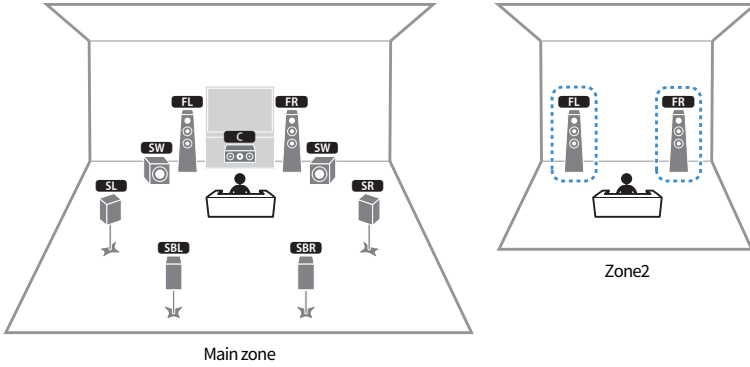

NOTE

- To use the Zone speaker system, the speaker configuration settings must be changed.
- You can also connect up to 2 subwoofers (with built-in amplifier) to the unit. Two subwoofers connected to the unit output the separate sounds, and so you can place them on the left/right or front/rear sides of the room. In this case, their layout settings must be changed.
- When using only one subwoofer, you can place it either in the left or right side.

Related links

- “Speaker requirements” (p.84)
- “Setting your speaker system” (p.226)
- “Setting the layout of the subwoofers” (p.234)
- “Playback in multiple rooms (multi zone function)” (p.181)

7.2.2 +1Zone

The Zone function allows you to play back an input source in the room where the unit is installed and in another room.

[Search tag]#Q01 Speaker systems

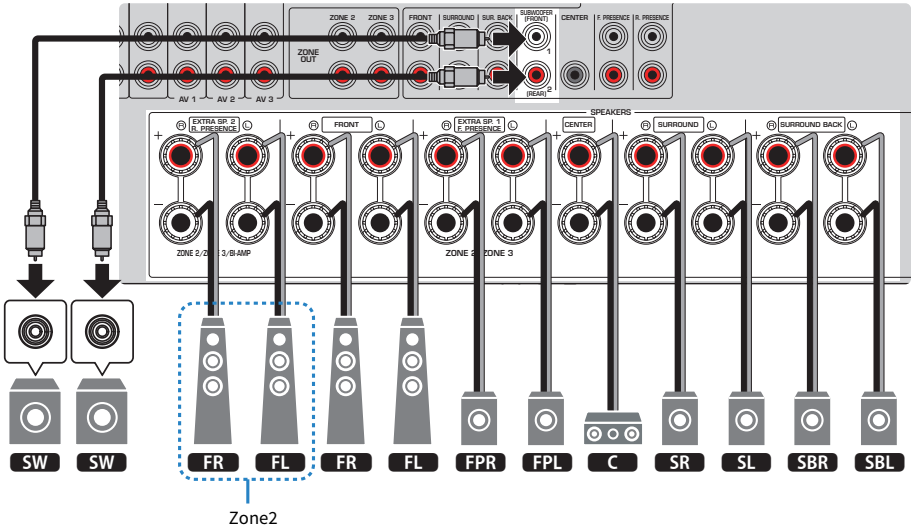
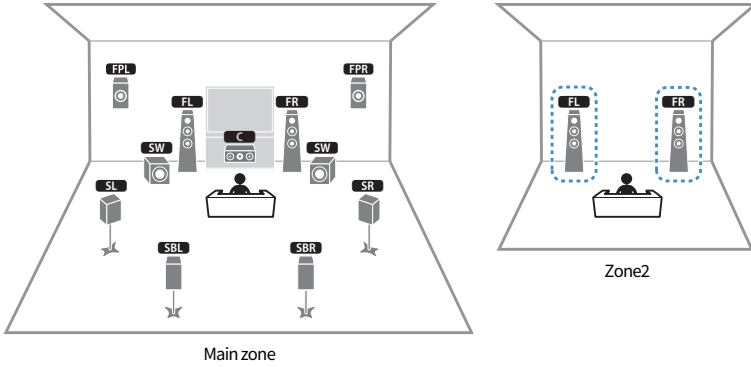

NOTE

- To use the Zone speaker system, the speaker configuration settings must be changed.
- You can also connect up to 2 subwoofers (with built-in amplifier) to the unit. Two subwoofers connected to the unit output the separate sounds, and so you can place them on the left/right or front/rear sides of the room. In this case, their layout settings must be changed.
- When using only one subwoofer, you can place it either in the left or right side.
- When Zone2 output is enabled, the surround back speakers in the Main zone do not output sound.

Related links

- “Speaker requirements” (p.84)
- “Setting your speaker system” (p.226)
- “Setting the layout of the subwoofers” (p.234)
- “Playback in multiple rooms (multi zone function)” (p.181)

7.2 +2Zone

The Zone function allows you to play back an input source in the room where the unit is installed and in other 2 rooms.

[Search tag]#Q01 Speaker systems

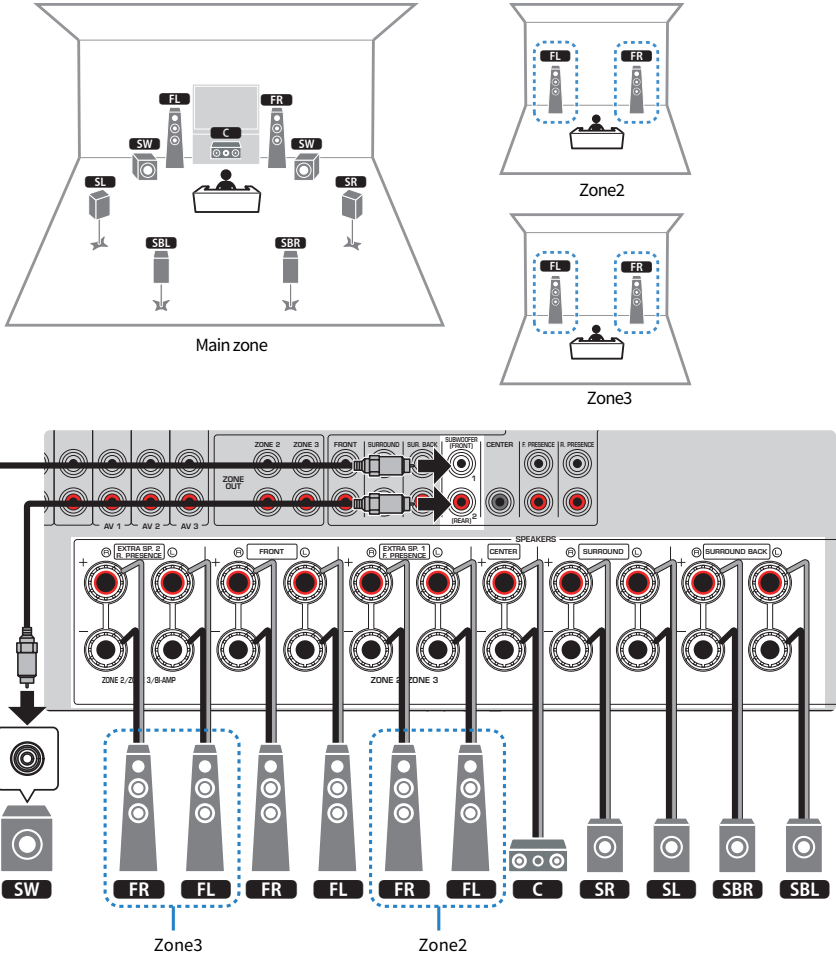

NOTE

- To use the Zone speaker system, the speaker configuration settings must be changed.
- You can also connect up to 2 subwoofers (with built-in amplifier) to the unit. Two subwoofers connected to the unit output the separate sounds, and so you can place them on the left/right or front/rear sides of the room. In this case, their layout settings must be changed.
- When using only one subwoofer, you can place it either in the left or right side.
- When Zone3 output is enabled, the surround back speakers in the Main zone do not output sound.

Related links

- “Speaker requirements” (p.84)
- “Setting your speaker system” (p.226)
- “Setting the layout of the subwoofers” (p.234)
- “Playback in multiple rooms (multi zone function)” (p.181)

7.2 Bi-Amp

You can connect the front speakers that support bi-amp connections. To enable the bi-amp function, configure the necessary speaker settings.

[Search tag]#Q01 Speaker systems

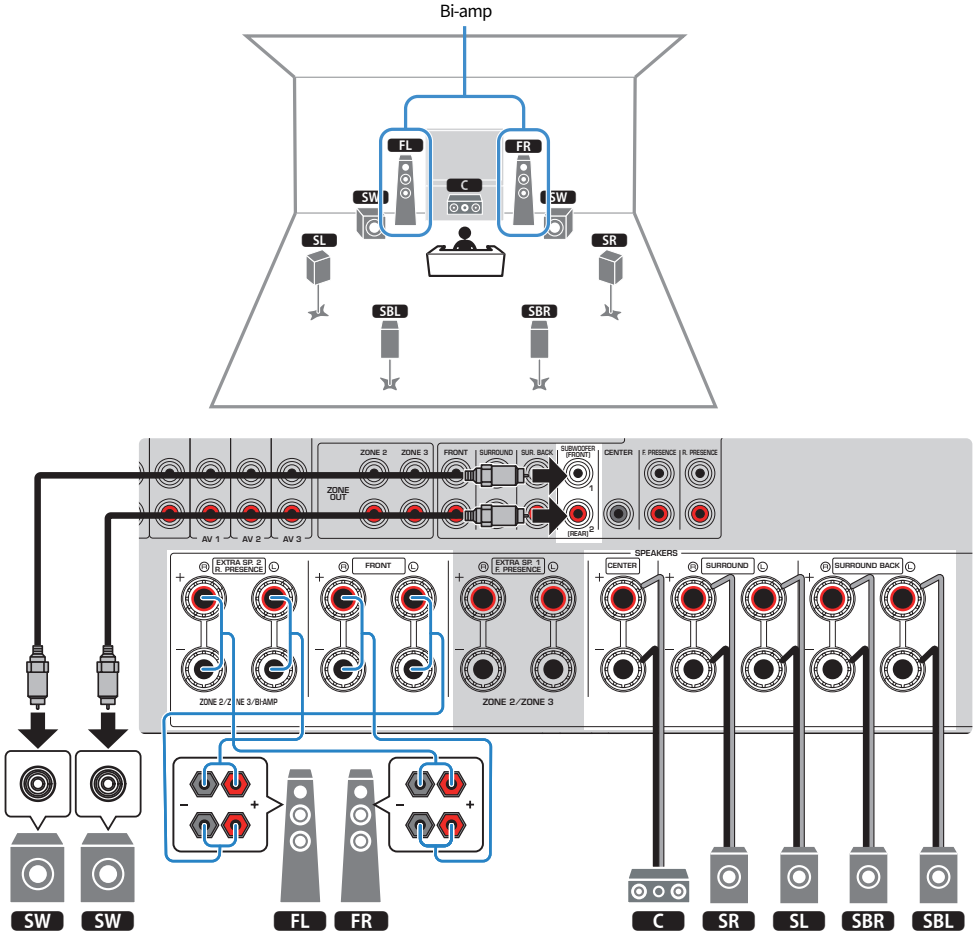

NOTICE

- Before making bi-amp connections, remove any brackets or cables that connect a woofer with a tweeter. If you are not making bi-amp connections, make sure that the brackets or cables are connected before connecting the speaker cables. Refer to the instruction manual of the speakers for details.

PREPARATIONS > How to place speakers (speaker systems)

NOTE

- The following speakers cannot be connected simultaneously.
 - Rear presence speakers
 - Bi-amp speakers
- You can also connect up to 2 subwoofers (with built-in amplifier) to the unit. Two subwoofers connected to the unit output the separate sounds, and so you can place them on the left/right or front/rear sides of the room. In this case, their layout settings must be changed.
- When using only one subwoofer, you can place it either in the left or right side.

Related links

- “Speaker requirements” (p.84)
- “Setting your speaker system” (p.226)
- “Setting the layout of the subwoofers” (p.234)

5.2.2 Bi-Amp

You can connect the front speakers that support bi-amp connections. To enable the bi-amp function, configure the necessary speaker settings.

[Search tag]#Q01 Speaker systems

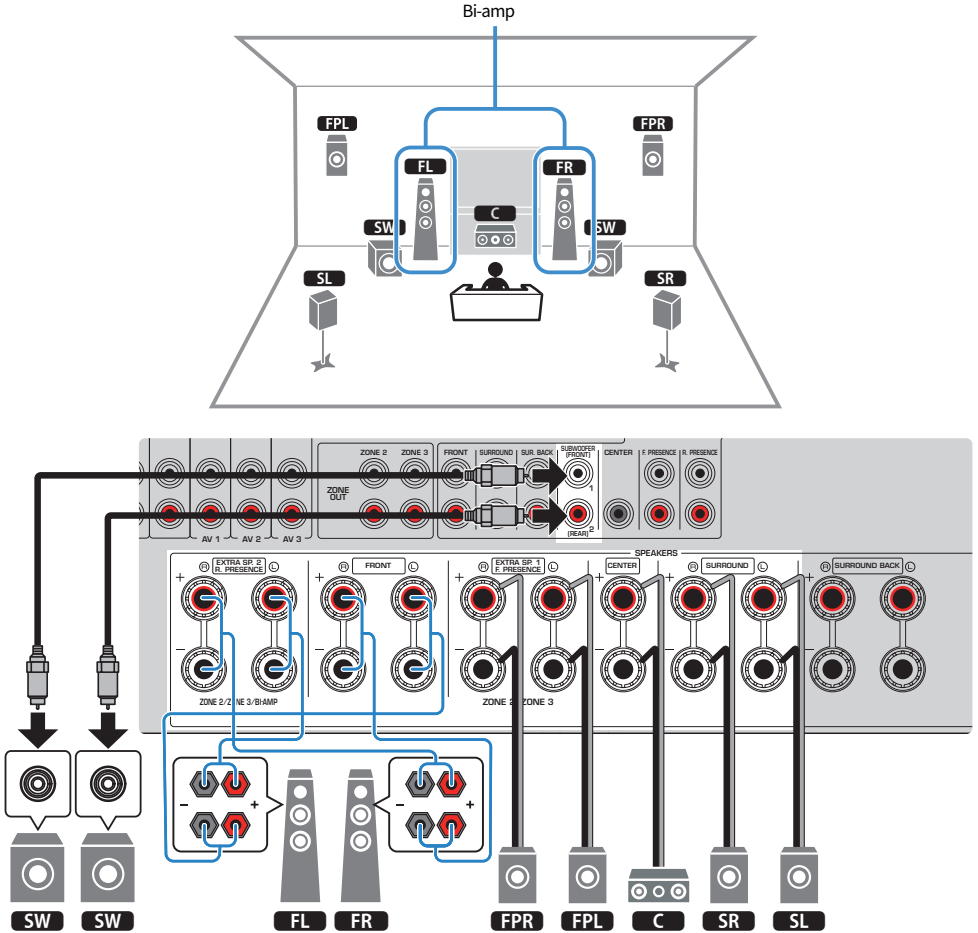

NOTICE

- Before making bi-amp connections, remove any brackets or cables that connect a woofer with a tweeter. If you are not making bi-amp connections, make sure that the brackets or cables are connected before connecting the speaker cables. Refer to the instruction manual of the speakers for details.

PREPARATIONS > How to place speakers (speaker systems)

NOTE

- The following speakers cannot be connected simultaneously.
 - Rear presence speakers
 - Bi-amp speakers
- You can also connect up to 2 subwoofers (with built-in amplifier) to the unit. Two subwoofers connected to the unit output the separate sounds, and so you can place them on the left/right or front/rear sides of the room. In this case, their layout settings must be changed.
- When using only one subwoofer, you can place it either in the left or right side.

Related links

- “Speaker requirements” (p.84)
- “Setting your speaker system” (p.226)
- “Setting the layout of the subwoofers” (p.234)

7.2 Bi-Amp +1Zone

You can connect the front speakers that support bi-amp connections. At the same time, the Zone function allows you to play back an input source in the room where the unit is installed and in another room. To enable the bi-amp function and the Zone function, configure the necessary speaker settings.

[Search tag]#Q01 Speaker systems

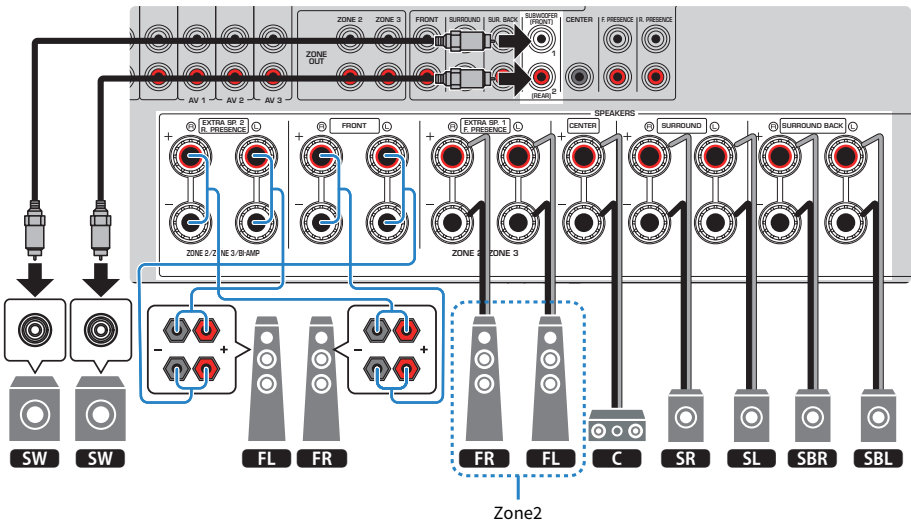
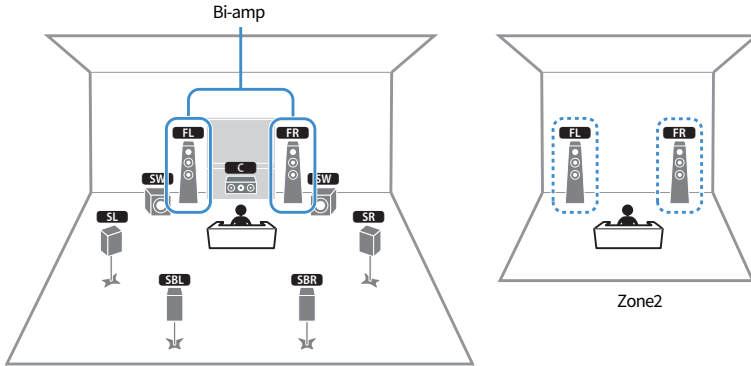

NOTICE

- Before making bi-amp connections, remove any brackets or cables that connect a woofer with a tweeter. If you are not making bi-amp connections, make sure that the brackets or cables are connected before connecting the speaker cables. Refer to the instruction manual of the speakers for details.

PREPARATIONS > How to place speakers (speaker systems)

NOTE

- The following speakers cannot be connected simultaneously.
 - Rear presence speakers
 - Bi-amp speakers
- You can also connect up to 2 subwoofers (with built-in amplifier) to the unit. Two subwoofers connected to the unit output the separate sounds, and so you can place them on the left/right or front/rear sides of the room. In this case, their layout settings must be changed.
- When using only one subwoofer, you can place it either in the left or right side.
- When Zone2 output is enabled, the surround back speakers in the Main zone do not output sound.

Related links

- “Speaker requirements” (p.84)
- “Setting your speaker system” (p.226)
- “Setting the layout of the subwoofers” (p.234)
- “Playback in multiple rooms (multi zone function)” (p.181)

Speaker systems using an external power amplifier (advanced setup)

List of speaker systems using an external power amplifier

In addition to the basic speaker systems, the unit also allows you to apply the following speaker configurations.

To enjoy following systems, configure the necessary speaker settings in “Power Amp Assign” in the “Setup” menu.

[Search tag]#Q01 Speaker systems

Main zone				Multi-zone	Power Amp Assign	Page
Output channel (max)	Bi-amp	Surround back/ Presence	Channel expansion (connecting external power amplifier)			
11	-	Surround back Front presence	Rear presence	-	7.2.4 [ext.RP]	p.76
11	-	Surround back Front presence Rear presence	Front	-	7.2.4 [ext.Front]	p.78
9	-	Surround back Front presence	Front	+1 room	7.2.2 [ext.Front] +1Zone	p.80
7	-	Surround back	Front	+2 rooms	7.2 [ext.Front] +2Zone	p.82

NOTE

You can build an 11-channel extended system only with the front speakers or the rear presence speakers using an external power amplifier.

Related links

- “Speaker requirements” (p.84)
- “Setting your speaker system” (p.226)
- “Connecting an external power amplifier” (p.74)

Connecting an external power amplifier

When connecting an external power amplifier (pre-main amplifier) to enhance speaker output, connect the input jacks of the power amplifier to the PRE OUT jacks of the unit.

The same channel signals are output from the PRE OUT jacks as from their corresponding SPEAKERS terminals.

NOTICE

To prevent the generation of loud noises or abnormal sounds, make sure the followings before making connections.

- Unplug the power cable of the unit and turn off the external power amplifier before connecting them.
- When using the PRE OUT jacks, do not connect speakers to the corresponding SPEAKERS terminals.
- When using a pre-main amplifier that does not have the volume control bypass, turn up the volume of the pre-main amplifier enough and fix it. In this case, do not connect other devices (except the unit) to the pre-main amplifier.

The unit (rear)

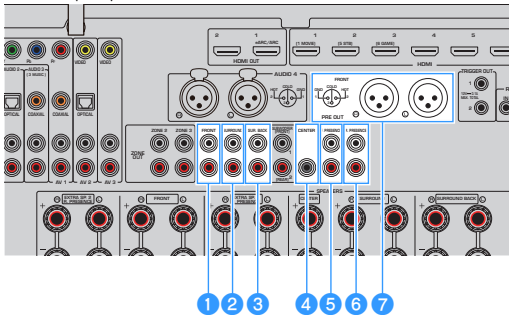

1 FRONT jacks

Outputs front left and right channel sounds.

2 SURROUND jacks

Outputs surround left and right channel sounds.

3 SUR. BACK jacks

Outputs surround back left and right channel sounds.

Under some speaker settings in “Power Amp Assign” in the “Setup” menu, the unit outputs no sounds from these PRE OUT jacks.

4 CENTER jack

Outputs center channel sounds.

5 F.PRESENCE jacks

Outputs front presence left and right channel sounds.

6 R.PRESENCE jacks

Outputs rear presence left and right channel sounds.

Under some speaker settings in “Power Amp Assign” in the “Setup” menu, the unit outputs no sounds from these PRE OUT jacks.

7 FRONT (XLR) jacks

Outputs front left and right channel sounds through XLR balanced cables.

NOTE

- Use XLR balanced cables to connect a power amplifier to the FRONT (XLR) jacks on the unit.
- Before connecting an XLR balanced cable, refer to the instruction manual of your device and verify that its XLR jacks are compatible with the pin assignments.
- For XLR output jacks, match the pins and insert the “female” plug of the XLR balanced cable until you hear a click. When disconnecting the cable from the unit, hold down the lever of the plug and then pull it out.
- We recommend using power amplifiers with volume control bypass (or without volume control circuit).
- When you set the following speaker settings in “Power Amp Assign” in the “Setup” menu, some outputs from the PRE OUT jacks are limited.
 - Basic
 - 7.2.2 +1Zone
 - 7.2 +2Zone
 - 7.2 Bi-Amp +1Zone

Related links

“Setting your speaker system” (p.226)

7.2.4 [ext.RP]

With the rear presence speakers using an external power amplifier, you can build an 11-channel extended system (7.2.4-channel system).

[Search tag]#Q01 Speaker systems

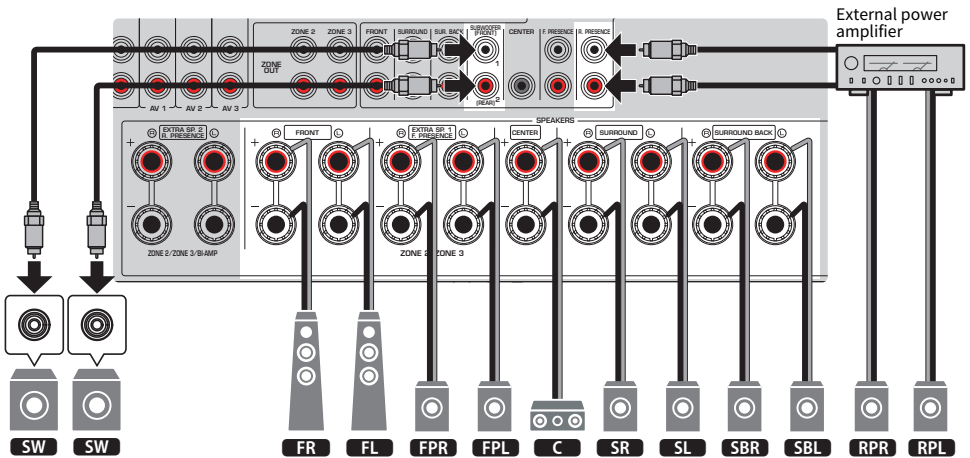
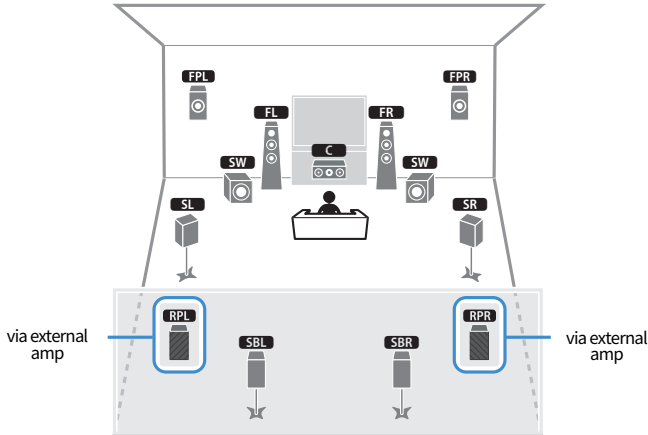

NOTE

- You can also connect up to 2 subwoofers (with built-in amplifier) to the unit. Two subwoofers connected to the unit output the separate sounds, and so you can place them on the left/right or front/rear sides of the room. In this case, their layout settings must be changed.
- When using only one subwoofer, you can place it either in the left or right side.

Related links

- “Speaker requirements” (p.84)
- “Setting your speaker system” (p.226)
- “Setting the layout of the subwoofers” (p.234)

7.2.4 [ext.Front]

With the front speakers using an external power amplifier, you can build an 11-channel extended system (7.2.4-channel system).

[Search tag]#Q01 Speaker systems

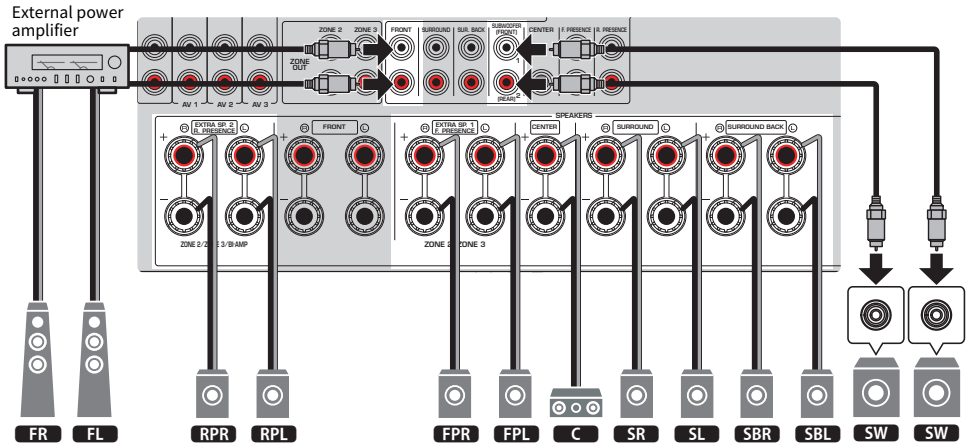
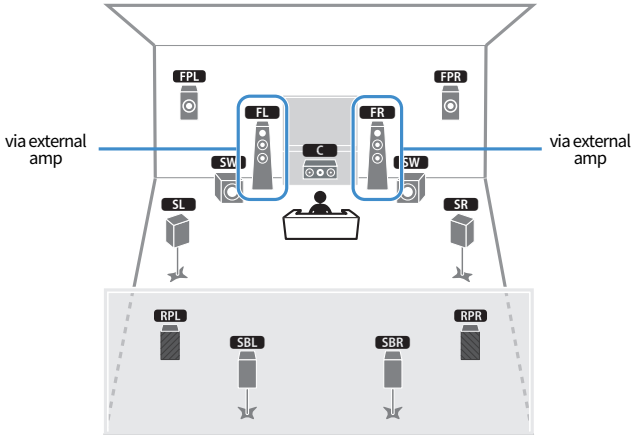

NOTE

- You can also connect up to 2 subwoofers (with built-in amplifier) to the unit. Two subwoofers connected to the unit output the separate sounds, and so you can place them on the left/right or front/rear sides of the room. In this case, their layout settings must be changed.
- When using only one subwoofer, you can place it either in the left or right side.

Related links

- “Speaker requirements” (p.84)
- “Setting your speaker system” (p.226)
- “Setting the layout of the subwoofers” (p.234)

7.2.2 [ext.Front] +1Zone

The Zone function allows you to play back an input source in the room where the unit is installed and in another room.

[Search tag]#Q01 Speaker systems

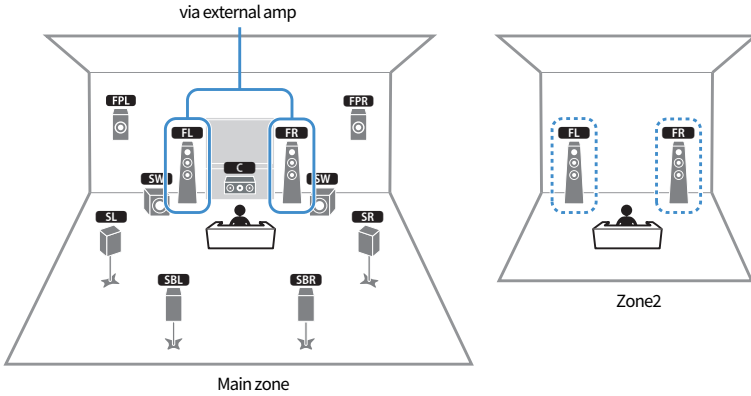

External power amplifier

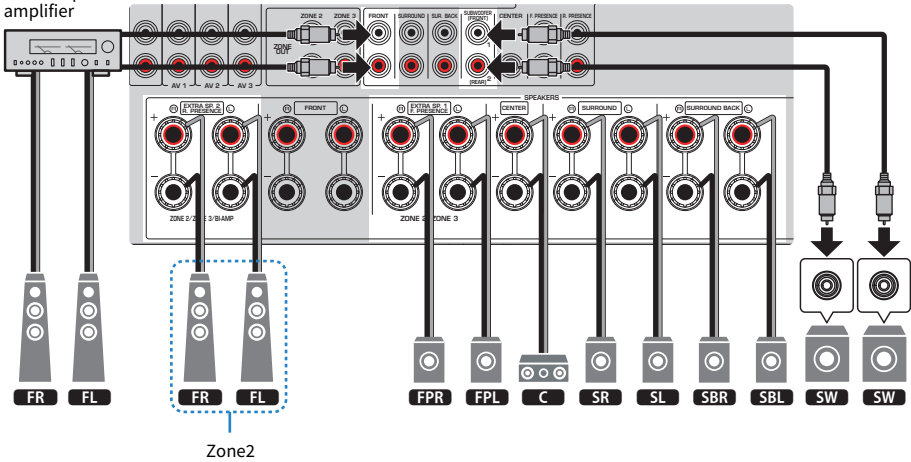

NOTE

- To use the Zone speaker system, the speaker configuration settings must be changed.
- You can also connect up to 2 subwoofers (with built-in amplifier) to the unit. Two subwoofers connected to the unit output the separate sounds, and so you can place them on the left/right or front/rear sides of the room. In this case, their layout settings must be changed.
- When using only one subwoofer, you can place it either in the left or right side.

Related links

- “Speaker requirements” (p.84)
- “Setting your speaker system” (p.226)
- “Setting the layout of the subwoofers” (p.234)
- “Playback in multiple rooms (multi zone function)” (p.181)

7.2 [ext.Front] +2Zone

The Zone function allows you to play back an input source in the room where the unit is installed and in other 2 rooms.

[Search tag]#Q01 Speaker systems

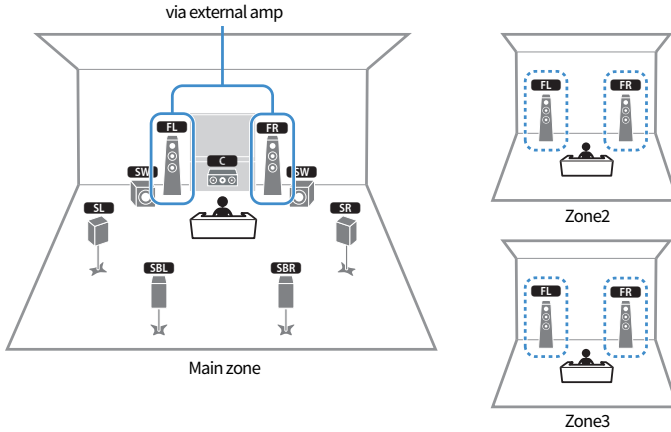

External power amplifier

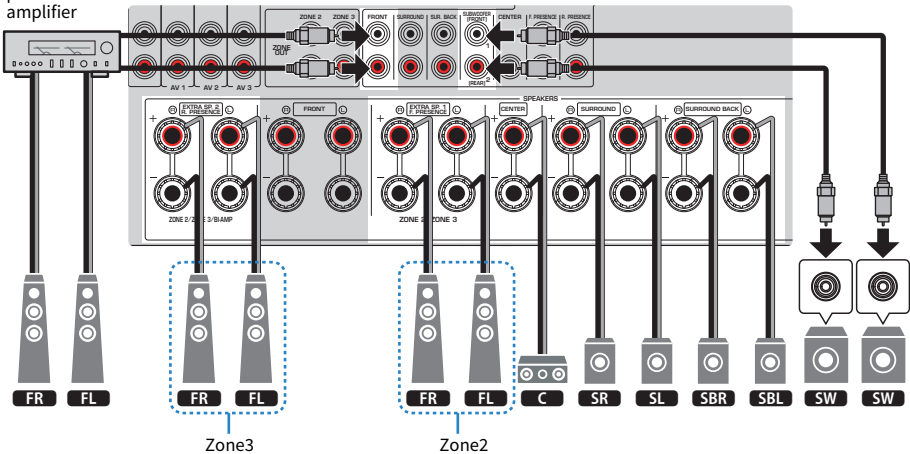

NOTE

- To use the Zone speaker system, the speaker configuration settings must be changed.
- You can also connect up to 2 subwoofers (with built-in amplifier) to the unit. Two subwoofers connected to the unit output the separate sounds, and so you can place them on the left/right or front/rear sides of the room. In this case, their layout settings must be changed.
- When using only one subwoofer, you can place it either in the left or right side.

Related links

- “Speaker requirements” (p.84)
- “Setting your speaker system” (p.226)
- “Setting the layout of the subwoofers” (p.234)
- “Playback in multiple rooms (multi zone function)” (p.181)

Connecting speakers

Speaker requirements

Speakers and subwoofers to be connected to the unit must meet the following requirements:

- Use following speakers.
 - the front speakers: with an impedance of at least 4-ohm
 - other speakers: with an impedance of at least 6-ohm
- Use a subwoofer with built-in amplifier.

[Search tag]#Q01 Speaker systems

NOTE

- Prepare the number of speakers according to your speaker system.
- Be sure to connect the front left and right speakers.
- When using surround back speakers, be sure to connect the surround back left and right speakers. Using only one surround back speaker was discontinued.
- Under its default settings, the unit is configured for 8-ohm speakers. When connecting 6-ohm speakers, set the unit's speaker impedance to "6Ω MIN".
- When connecting the front speakers with an impedance of 4-ohm, set the unit's speaker impedance to "6Ω MIN".

Related links

- "Setting the speaker impedance" (p.239)
- "Cable requirements" (p.85)

Cable requirements

Use the following types of commercially-available cables to connect speakers to the unit:

- Speaker cables (for connecting the speakers)



- Audio pin cable (for connecting a subwoofer)



Related links

[“Connecting the speaker” \(p.86\)](#)

How to connect speakers

Connecting the speaker

Connect a speaker cable between the negative (-) terminal of the unit and the negative (-) terminal of the speaker, and between the positive (+) terminal of the unit and the positive (+) terminal of the speaker.

Remove the unit's power cable from an AC wall outlet before connecting the speaker.

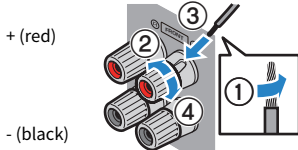

NOTICE

- Prepare speaker cables in a place away from the unit, to avoid accidentally dropping wire strands into the unit's interior which could result in a short circuit or malfunction of the unit.
- Improper connecting of the speaker cables may cause a short circuit and also damage the unit or the speakers.
 - Do not let the bare wires of the speaker cable touch one another.

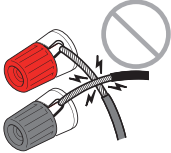

- Do not let the bare wires of the speaker cable come into contact with the unit's metal parts (rear panel and screws).

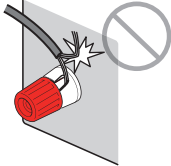

- 1 Remove approximately 10 mm (3/8") of insulation from the ends of the speaker cable, and twist the bare wires of the cable firmly together.**

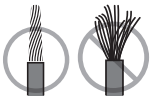

- 2 Loosen the speaker terminal.**
- 3 Insert the bare wires of the cable into the gap on the side of the terminal.**
- 4 Tighten the terminal.**

This completes the connection.

NOTE

- If “Check SP Wires” appears on the front display when the unit is turned on, turn off the unit, and then confirm that the speaker cables are not short circuited.
- (U.S.A., Canada, China, Taiwan, Brazil, Central and South America and General models only)
When using a banana plug, tighten the speaker terminal and insert a banana plug into the end of the terminal.

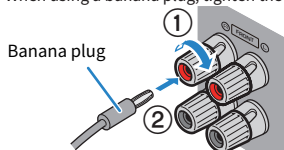

Related links

“Connecting the subwoofer” (p.88)

Connecting the subwoofer

Use an audio pin cable to connect the subwoofer.

Unplug the power cables of the unit and subwoofer from the AC wall outlets before connecting the subwoofer.

Audio pin cable

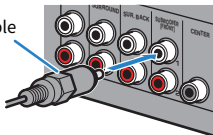

Related links

[“HDMI connection with a TV” \(p.89\)](#)

Connecting a TV

HDMI connection with a TV

Connect a TV to the unit with an HDMI cable. When the TV audio is played back on the unit, use eARC/ARC function or use a digital optical cable to input TV audio to the unit.

[Search tag]#Q02 Connect TV

NOTE

- Use a 19-pin HDMI cable with the HDMI logo. We recommend using a cable as short as possible to prevent signal quality degradation.
- Use a Ultra High Speed HDMI Cable or Ultra High Speed HDMI Cable with Ethernet to enjoy 8K videos.
- Use a Premium High Speed HDMI Cable or Premium High Speed HDMI Cable with Ethernet to enjoy 3D or 4K Ultra HD videos.
- When using eARC/ARC, connect a TV with an HDMI cable that supports eARC/ARC (such as a High Speed HDMI Cable with Ethernet).
- You may need setting on the TV. Refer to the instruction manual for the TV.

■ Using eARC/ARC function

If your TV supports eARC/ARC, the TV audio is played back on the unit with only one HDMI cable. When using ARC, set the HDMI Control function to “On”.

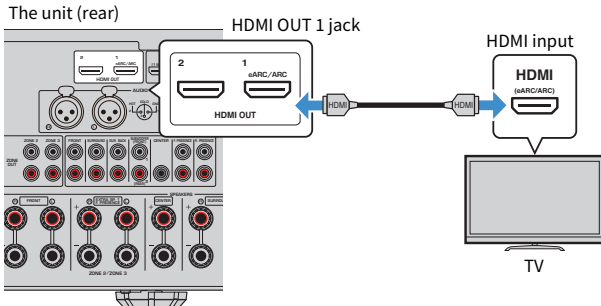

NOTE

- “ARC” is an abbreviation of Audio Return Channel. “ARC” allows that the TV audio is played back on AV products (such as AV receiver, sound bar), by connecting the HDMI input jack that supports ARC of your TV to the HDMI OUT jack that supports ARC of your AV products with only an HDMI cable, without a digital optical cable.
- “eARC” is an abbreviation of enhanced Audio Return Channel. “eARC”, enhanced the function of ARC, supports uncompressed 5.1-channel and 7.1-channel audio formats, object-based surround (such as Dolby Atmos and DTS:X), and AURO-3D via compatible TV with the HDMI cable.

Related links

- “Playback of TV audio with eARC/ARC” (p.155)
- “HDMI connection with another TV or a projector” (p.91)

■ Connecting a digital optical cable

If your TV does not support eARC/ARC, connect your TV to AUDIO 1 OPTICAL jack on the unit with a digital optical cable.

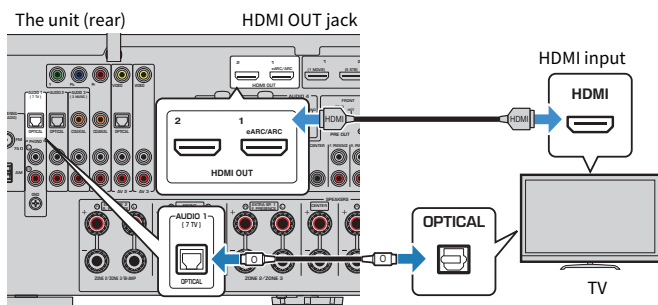

NOTE

- If you connect your TV to the OPTICAL jack except AUDIO 1 with a digital optical cable, set “TV Audio Input” in the “Setup” menu.
- According to the audio output jacks of your TV, you can connect your TV to the unit with an audio cable (digital coaxial or stereo pin cable) other than a digital optical cable. In this case, set “TV Audio Input” in the “Setup” menu.

Related links

- “Playback of TV audio with a digital optical cable” (p.156)
- “HDMI connection with another TV or a projector” (p.91)
- “Setting the audio input jack used for TV audio” (p.314)

HDMI connection with another TV or a projector

The unit has multiple HDMI output jacks. If you connect another TV or a projector to the unit with an HDMI cable, you can switch the TV (or projector) to be used for watching videos with the remote control.

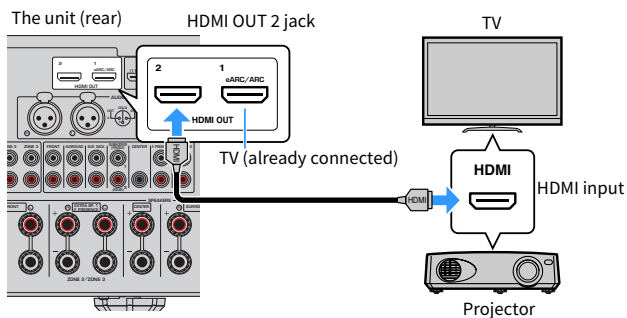

NOTE

HDMI Control is not available on the HDMI OUT 2 jack.

Related links

- “Selecting an HDMI output jack” (p.152)
- “HDMI connection with a video device such as a BD/DVD player” (p.92)

Connecting playback devices

HDMI connection with a video device such as a BD/DVD player

Connect a video device to the unit with an HDMI cable.

The unit (rear)

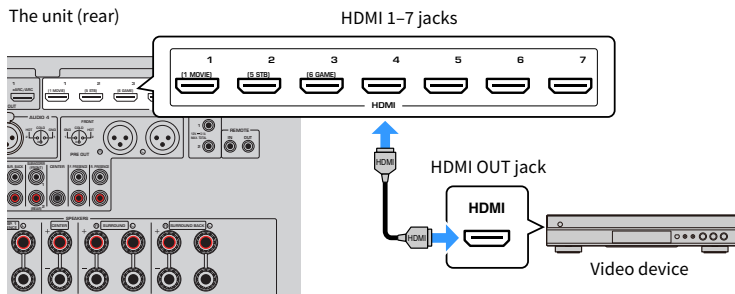

Related links

“VIDEO (component video) connection with a video device” (p.93)

Connection other than HDMI with a playback device

VIDEO (component video) connection with a video device

Connect a video device to the unit with a component video cable and an audio cable.

Depending on the audio output jacks available on your video device, choose one of the following connections.

Output jacks on video device		Input jacks on the unit
Video	Audio	
Component video	Digital coaxial	AV 1 (COMPONENT VIDEO + COAXIAL)
	Analog stereo	AV 1 (COMPONENT VIDEO + AUDIO)

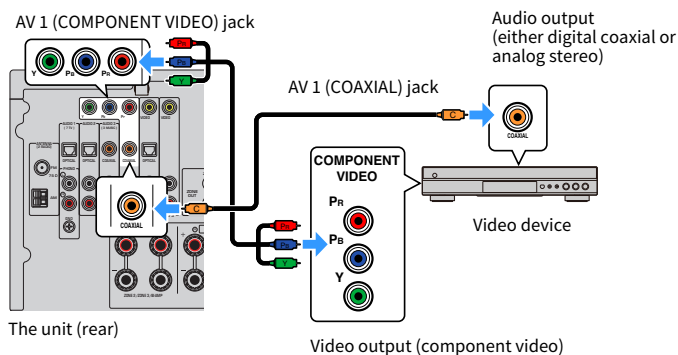

NOTE

The unit supports the component video signals of 480i/576i, 480p/576p, 720p and 1080i (resolution).

Related links

“VIDEO (composite video) connection with a video device” (p.94)

VIDEO (composite video) connection with a video device

Connect a video device to the unit with a video pin cable and an audio cable.

Depending on the audio output jacks available on your video device, choose one of the following connections.

Output jacks on video device		Input jacks on the unit
Video	Audio	
Composite video	Digital optical	AV 2 (VIDEO + OPTICAL)
	Analog stereo	AV 2-3 (VIDEO + AUDIO)

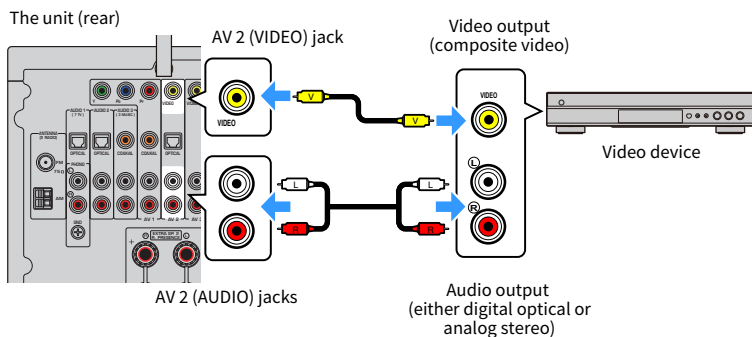

NOTE

The unit supports the composite video signals of 480i/576i (resolution).

Related links

“AUDIO connection with an audio device such as a CD player” (p.95)

AUDIO connection with an audio device such as a CD player

Connect audio devices such as CD players to the unit.

Depending on the audio output jacks available on your audio device, choose one of the following connections.

Audio output jacks on audio device	Audio input jacks on the unit
Digital coaxial	AUDIO 3 (COAXIAL) AV 1 (COAXIAL)
Digital optical	AUDIO 1-2 (OPTICAL) AV 2 (OPTICAL)
Analog stereo (RCA)	AUDIO 2-3 (AUDIO [RCA]) AV 1-3 (AUDIO [RCA])
Analog stereo (XLR)	AUDIO 4 (AUDIO [XLR])
Turntable (PHONO)	PHONO

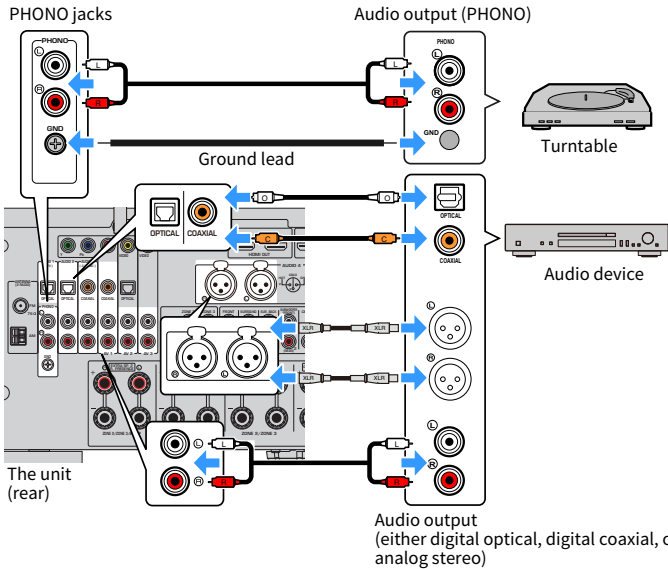

NOTE

- Before connecting an XLR balanced cable, refer to the instruction manual of your device and verify that its XLR jacks are compatible with the pin assignments.
- For XLR input jacks, match the pins and insert the “male” plug of the XLR balanced cable until you hear a click. When disconnecting the cable from the unit, hold down the PUSH button on the unit and then pull the plug out.
- The PHONO jack of the unit is compatible with an MM cartridge. To connect a turntable with a low-output MC cartridge, use a boosting transformer.
- Connecting the turntable to the GND terminal of the unit may reduce noise in the signal. (This GND terminal is not a safety ground.)

Related links

- “Part names and functions of the rear panel” (p.32)
- “Connecting the FM antenna” (p.97)
- “Connecting the DAB/FM antenna” (p.100)

Connecting the radio antennas

Connecting the FM antenna

Model For

U.S.A., Canada, Asia, Korea, China, Taiwan, Brazil, General, and Central and South America

Connect the supplied FM antenna to the unit.

Fix the end of the FM antenna to a wall.

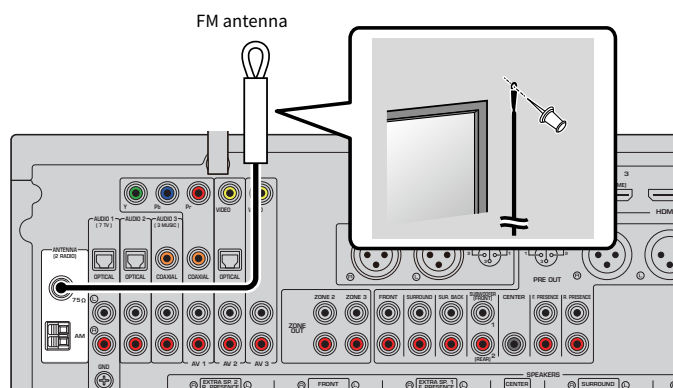

The unit (rear)

Related links

[“Connecting the AM antenna” \(p.98\)](#)

Connecting the AM antenna

Model For

U.S.A., Canada, Asia, Korea, China, Taiwan, Brazil, General, and Central and South America

Connect the supplied AM antenna to the unit.

Place the AM antenna on a flat surface.

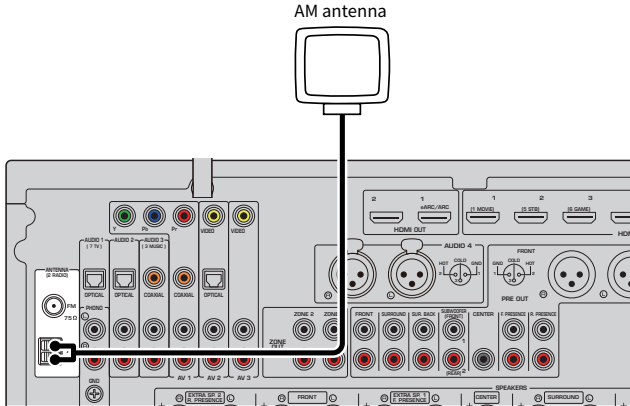

Assembling and connecting the AM antenna

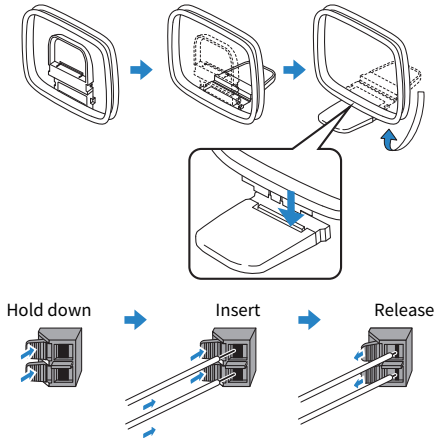

NOTE

- Unwind only the length of cable needed from the AM antenna unit.
- The wires of the AM antenna have no polarity.

PREPARATIONS > Connecting the radio antennas

Related links

“Network connection of the unit” (p.101)

Connecting the DAB/FM antenna

Model For

U.K., Europe, Russia and Australia

Connect the supplied DAB/FM antenna to the unit.

Fix the antenna ends to a wall.

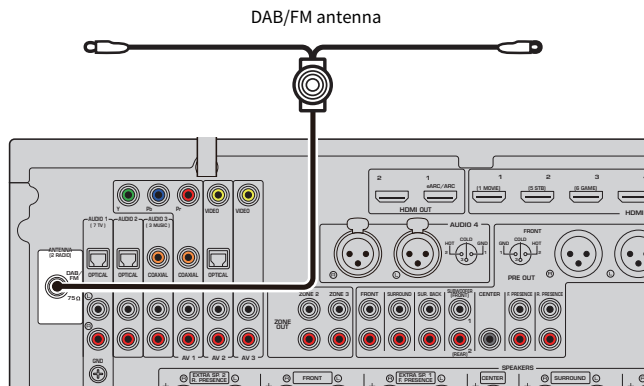

The unit (rear)

NOTE

- The antenna should be stretched out horizontally.
- If you cannot obtain good reception on the radio, adjust the height, direction or placement of the DAB/FM antenna.

Related links

“Network connection of the unit” (p.101)

Preparing for connecting to a network

Network connection of the unit

The unit supports wired and wireless connections.

Select a connection method according to your network environment.

You can enjoy Internet radio or music files stored on media servers, such as PCs and Network Attached Storage (NAS), on the unit.

NOTICE

- Do not connect this product to public Wi-Fi and/or Internet directly. Only connect this product to the Internet through a router with strong password-protections. Consult your router manufacturer for information on security best practices.

Related links

- “Connecting a network cable (wired connection)” (p.102)
- “Preparing wireless antennas (wireless connection)” (p.103)

Connecting a network cable (wired connection)

Connect the unit to your router with a commercially-available STP network cable (CAT-5 or higher straight cable).

When using a router that supports DHCP, you do not need to configure any network settings for the unit.

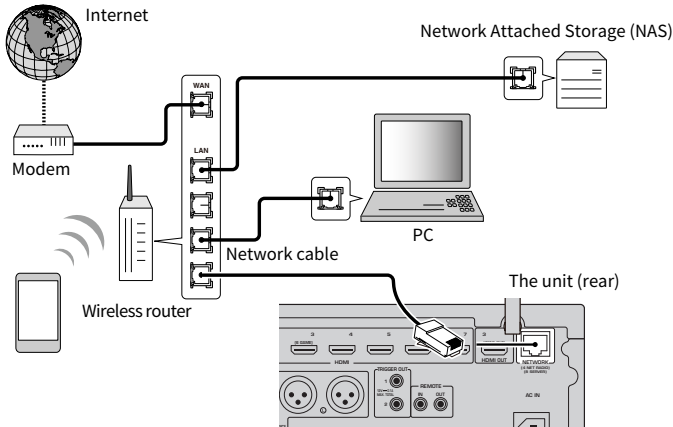

NOTE

You need to configure the network settings if your router does not support DHCP or if you want to configure the network parameters manually.

Related links

- “Setting the network parameters manually” (p.287)
- “Checking the network information of the unit” (p.284)
- “Connecting an external power amplifier” (p.74)

Preparing wireless antennas (wireless connection)

Stand the wireless antennas upright for connecting to the wireless network or a Bluetooth device wirelessly.

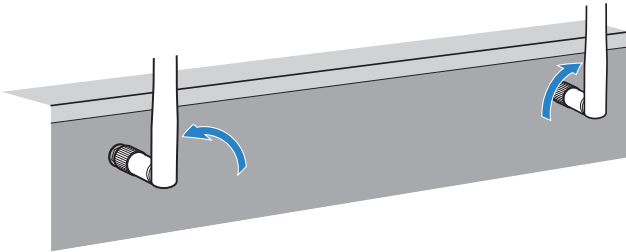

NOTICE

- Do not apply excessive force on the wireless antenna. Doing so may damage the antenna.

Related links

- “Adding the unit to the MusicCast network” (p.112)
- “Selecting a wireless network connection method” (p.414)
- “Connecting a device compatible with the trigger function” (p.104)

Connecting other devices

Connecting a device compatible with the trigger function

The trigger function can control an external device in conjunction with operating the unit (such as powering on/off and input selection). If you have a Yamaha subwoofer that supports a system connection or a device with a trigger input jack, you can use the trigger function by connecting the external device to the TRIGGER OUT jack with a monaural mini-jack cable.

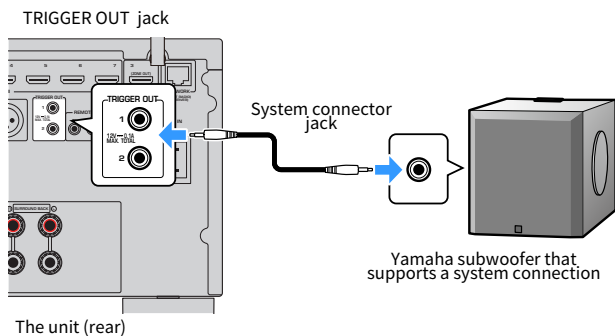

Related links

- “Operating the unit from another room (remote connection)” (p.105)
- “Specifying the zone with which the TRIGGER OUT jack functions are synchronized” (p.332)

Operating the unit from another room (remote connection)

You can operate the unit or external devices from another room (a zone) using the remote control supplied with each device if you connect an infrared signal receiver/emitter to the unit's REMOTE IN/OUT jacks.

The unit (rear)

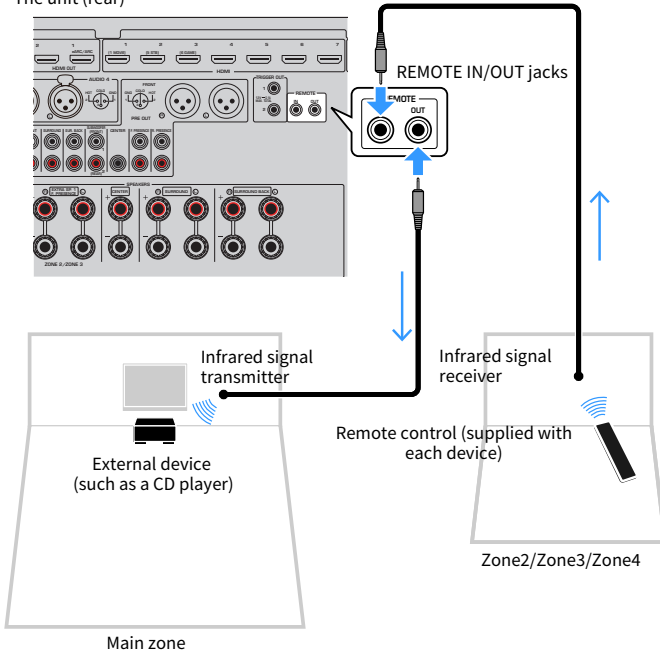

An infrared signal transmitter is not required if you are using Yamaha products that support remote connections, as the unit does. You can transmit remote control signals by connecting the REMOTE IN/OUT jacks with monaural mini-jack cables and an infrared signal receiver.

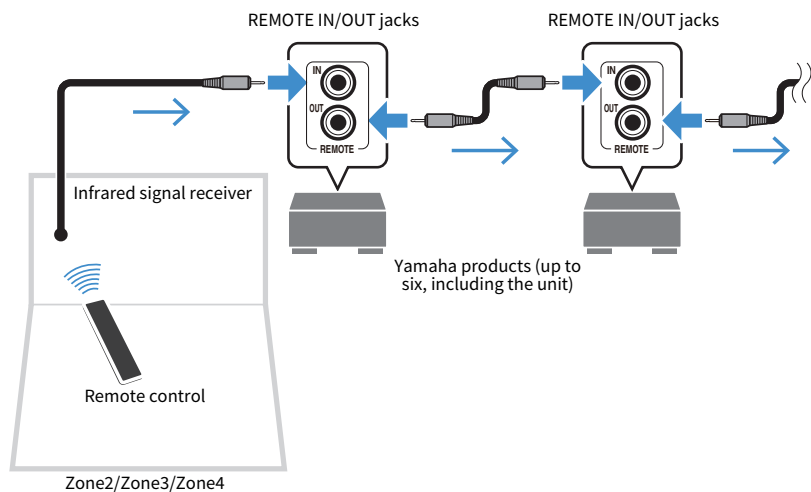

Related links

"Plugging in the power cable" (p.107)

Turning on the power of the unit

Plugging in the power cable

After all the connections are complete, plug in the power cable.

The unit (rear)

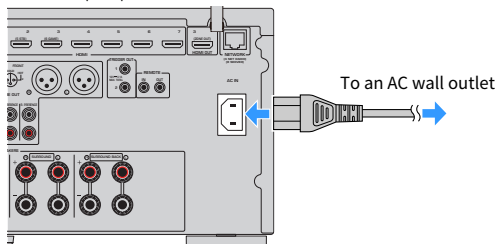

Related links

“Setting the power to on/standby (Main zone)” (p.108)

Setting the power to on/standby (Main zone)

Switch the power of Main zone between on and standby.

NOTE

Main zone is the room where the unit is installed.

1 Set the zone switch to “MAIN”.

2 Press .

Each time you press the key, you can switch the power of Main zone between on and standby.

NOTE

When you turn on the unit for the first time, the message regarding the network setup appears on the TV. If you use an iPhone, you can set up a wireless connection by following the on-screen instructions.

Related links

- “Part names and functions of the remote control” (p.34)
- “Selecting the menu language” (p.109)

Selecting the menu language

Selecting the menu language

To set the desired menu language, switch the input of the TV to display video from the unit and press SETUP. And then, select "Language" in "System" in the "SETUP" menu.

Related links

- "Setting the menu language" (p.312)
- "Basic operation of the Setup menu" (p.214)
- "What is MusicCast" (p.110)

Setting MusicCast

What is MusicCast

MusicCast is a wireless musical solution from Yamaha, allowing you to share music among all of your rooms with a variety of devices. You can enjoy music from your smartphone, PC, NAS drive, Internet radio station and music streaming service anywhere in your house with one easy-to-use dedicated application “MusicCast Controller”.

For more details and a lineup of MusicCast compatible products, visit the Yamaha website.

Related links

“Using MusicCast Controller” (p.111)

Using MusicCast Controller

To use the network features on the MusicCast compatible device, you need the dedicated application “MusicCast Controller” for the operation. Search for the free application “MusicCast Controller” on the App Store or Google Play and install it to your device.

Related links

“Adding the unit to the MusicCast network” (p.112)

Adding the unit to the MusicCast network

Perform the following procedure to add the unit to the MusicCast network. You can also configure the unit's wireless network settings at once.

- 1 Launch the “MusicCast Controller” application on your mobile device and tap “Setup”.**
- 2 Operate the “MusicCast Controller” application following the on-screen instructions.**

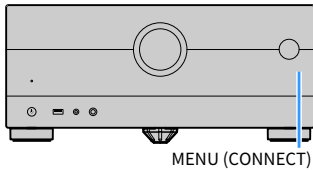

NOTE

- If you configure the unit's wireless network settings with this method, the SSID and security key for your wireless LAN router (access point) will be needed.
- If you add the second or later MusicCast compatible device, tap “Settings” and then “Add New Device” in the “MusicCast Controller” application.
- When you add the unit to the MusicCast network, the wireless LAN indicator sometimes lights up on the front display even if a wired connection is used.



Related links

- “Setting the power interlock from the unit to MusicCast compatible devices” (p.292)
- “Configuring wireless speakers” (p.113)
- “Flow of the speaker configurations” (p.115)

Using the MusicCast Surround function

Configuring wireless speakers

Using devices that support the MusicCast Surround function, you can enjoy a 5.1.2-channel or 5.1-channel system with wireless surround speakers and subwoofer.

NOTE

Refer to the instruction manual of the devices that support the MusicCast Surround function for details on settings and operations.

■ Devices supporting MusicCast Surround

As of March 1, 2021

Wireless Streaming Speaker



MusicCast 50



MusicCast 20

Network Subwoofer

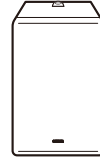

MusicCast SUB 100

■ Sample speaker layout

The following is a 5.1.2-channel system using two MusicCast 20 speakers as the surround speakers and one MusicCast SUB 100 as the subwoofer.

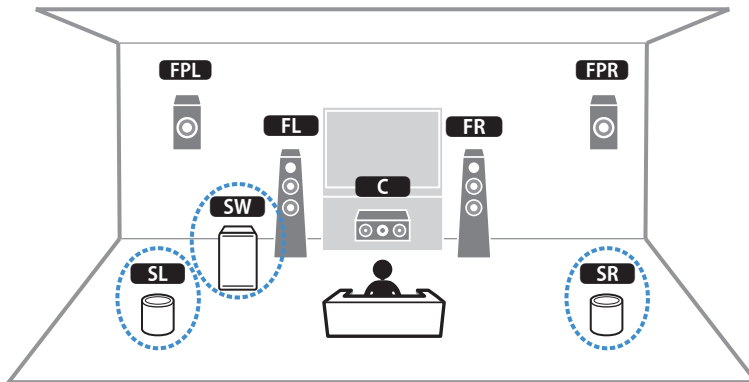

NOTE

- In a 5.1.2-channel or 5.1-channel system, the surround speakers and subwoofer can be wireless. With other systems, only the subwoofer can be wireless.
- With wireless surround speakers
 - Sound will not be output from the speaker terminals (SURROUND) and pre-out jacks (SURROUND) on the unit.
 - Surround back speakers cannot be used.
- With a wireless subwoofer
 - One subwoofer can be wireless.
 - Sound will not be output from the pre-out jacks (SUBWOOFER 1 and 2) on the unit. Therefore, another subwoofer cannot be used by connecting it with an audio cable.
- The following audio cannot be output from the wireless surround speakers and subwoofer.
 - DSD audio
 - DVD-Audio and Super Audio CD (SACD) from HDMI input

1 The unit and the devices supporting MusicCast Surround must be registered with the same location on the MusicCast Controller app.

2 Follow the app's on-screen instructions to complete setup of the MusicCast Surround function.

For detailed setup instructions, refer to the following.

<https://download.yamaha.com/files/tcm:39-1212383>

Related links

“Flow of the speaker configurations” (p.115)

Configuring the speaker settings

Flow of the speaker configurations

Before using the unit, adjust the speaker settings such as volume balance and acoustic parameters. With the supplied YPAO microphone, the unit detects speaker connections and measures the distances from them to your listening position(s) that is measuring position(s). And then, the unit automatically optimizes the speaker settings such as volume balance and acoustic parameters. (YPAO: Yamaha Parametric room Acoustic Optimizer)

NOTE

- During the measuring process, test tones are output at high volume. You cannot adjust the volume.
- During the measuring process, stay in a back corner of the room and note the following for accurate measurement.
 - Keep the room as quiet as possible.
 - Do not block sound between the speakers and the YPAO microphone.
- Do not connect headphones.

- 1 Select the unit's speaker impedance settings as necessary.**
- 2 Configure the corresponding speaker settings.**
- 3 Set the volume of the subwoofer to half. If the crossover frequency is adjustable, set it to maximum.**

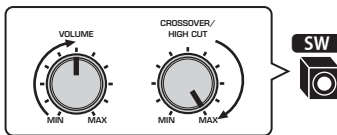

- 4 Place the YPAO microphone at your listening position (same height as your ears).**

We recommend the use of a tripod as a microphone stand and adjust your listening position (same height as your ears). You can use the tripod screws to stabilize the microphone.

5 Connect the YPAO microphone to the YPAO jack.

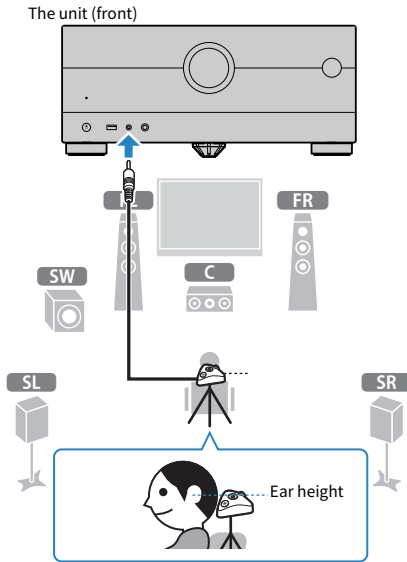

The following screen appears on the TV.

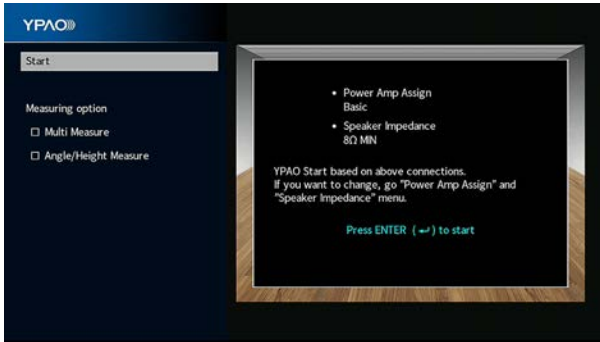

If you want to enable an item under “Measuring option”, select the item and check its box.

6 According to the guidance displayed on the screen, start the measurement.

The following screen appears on the TV when the measurement finishes.

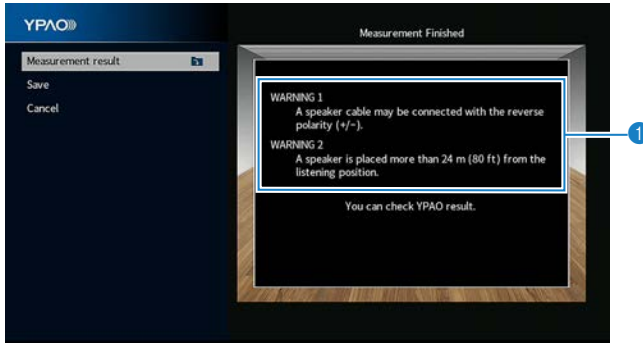

1 Warning message (if available)

7 Select “Save” to apply the measurement results to the speaker settings.

8 Disconnect the YPAO microphone from the unit.

This completes optimization of the speaker settings.

NOTICE

- The YPAO microphone is sensitive to heat, so should not be placed anywhere it could be exposed to direct sunlight or high temperatures (such as on top of AV equipment).

NOTE

- An error message may appear during the measurement.
- “YPAO Volume” in the “Option” menu is automatically enabled after the YPAO measurement. Then, the high- and low-frequency levels are automatically adjusted according to the volume so that you can enjoy natural sounds even at low volume.
- If the speaker settings you have configured manually are not suitable, discard the manual settings and reload the previous YPAO adjustments.
- To cancel the operation, disconnect the YPAO microphone before starting the measurement.
- YPAO multi measurement option cannot be enabled with wireless speakers.

Related links

- “Setting the speaker impedance” (p.239)
- “Assigning speaker configuration” (p.118)
- “Configuring the speaker settings automatically based on the YPAO measurement results” (p.121)
- “Error messages from YPAO” (p.129)
- “Warning messages from YPAO” (p.130)
- “Adjusting the high- and low-frequency levels automatically according to the volume” (p.195)
- “Reloading the previous YPAO adjustments” (p.241)

Assigning speaker configuration

If you use any of the following speaker configurations, configure the corresponding speaker settings manually.

- **When using the surround back speakers**
- **When using bi-amp connections or zone connections**
- **When using the surround speakers placed in front (Virtual CINEMA FRONT)**
- **When using the front presence speakers for Dolby Atmos, DTS:X or AURO-3D playback**

Related links

- [“Setting your speaker system” \(p.226\)](#)
- [“Setting the layout of the surround speakers” \(p.228\)](#)
- [“Presence speaker layout” \(p.420\)](#)

Optional measurement of YPAO

YPAO measuring at multiple listening positions (multi measure)

Select “Multi Measure” option if you will have several listening positions or if you want others to enjoy surround sound. You can take measurements at up to 8 different positions in the room. The speaker settings will be optimized to suit the area defined by those positions.

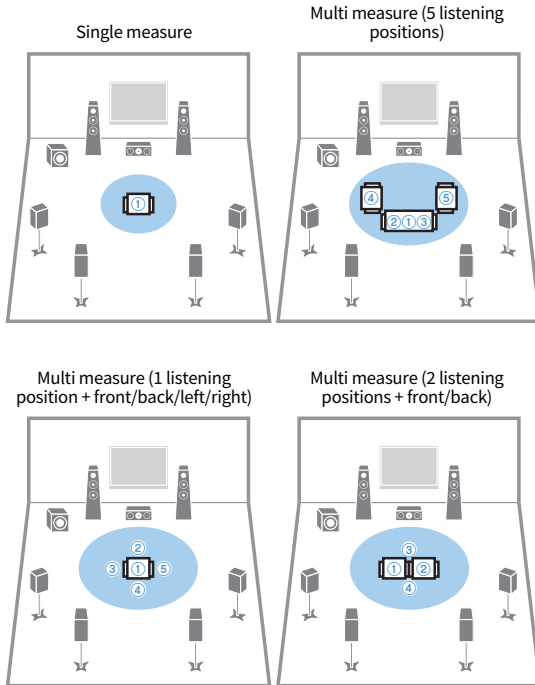

NOTE

- First place the YPAO microphone at the listening position you will be seated most frequently.
- YPAO multi measurement option cannot be enabled with wireless speakers.
- “Angle/Height Measure” option is also selectable with this measurement.

Related links

- “YPAO measuring the angle and height of speakers (angle/height measure)” (p.120)
- “Configuring the speaker settings automatically based on the YPAO multi measurement results” (p.121)

YPAO measuring the angle and height of speakers (angle/height measure)

Select “Angle/Height Measure” option so that CINEMA DSP can create more effective sound fields. The unit will measure angle of each speaker and height of the presence speakers at the listening position, and correct the speaker parameters.

NOTE

“Multi Measure” option is also selectable with this measurement.

Related links

- “YPAO measuring at multiple listening positions (multi measure)” (p.119)
- “Configuring the speaker settings automatically based on the YPAO measurement results with the angle/height measurement” (p.124)

Configuring the speaker settings automatically based on the YPAO measurement results

Configuring the speaker settings automatically based on the YPAO multi measurement results

Perform the following procedure to take a measurement when the “Multi Measure” option is selected. It takes about 15 minutes to measure 8 listening positions.

NOTE

- During the measuring process, test tones are output at high volume. You cannot adjust the volume.
- During the measuring process, stay in a back corner of the room and note the following for accurate measurement.
 - Keep the room as quiet as possible.
 - Do not block sound between the speakers and the YPAO microphone.
- Do not connect headphones.
- YPAO multi measurement option cannot be enabled with wireless speakers.

- 1 Select the unit’s speaker impedance settings as necessary.**
- 2 Configure the corresponding speaker settings.**
- 3 Set the volume of the subwoofer to half. If the crossover frequency is adjustable, set it to maximum.**

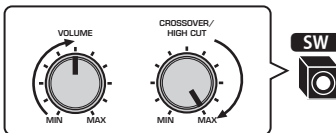

- 4 Place the YPAO microphone at your listening position (same height as your ears).**

We recommend the use of a tripod as a microphone stand and adjust your listening position (same height as your ears). You can use the tripod screws to stabilize the microphone.

5 Connect the YPAO microphone to the YPAO jack.

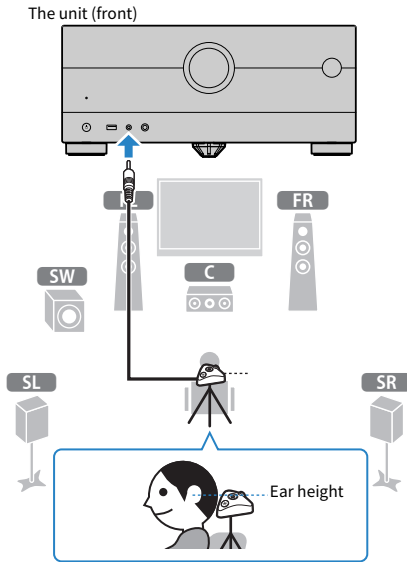

6 Select “Multi Measure” under “Measuring option”.

7 According to the guidance displayed on the screen, start the measurement.

The following screen appears on the TV when the measurement at the first position finishes.

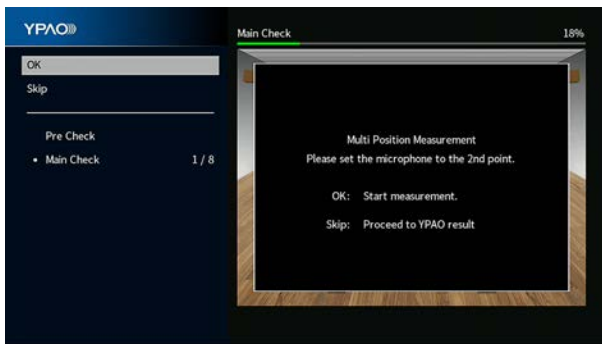

8 Move the YPAO microphone to the next listening position and press ENTER.

Repeat it until measurements at all listening positions (up to 8) have been taken.

9 When the measurements at the positions you want to measure are completed, select “Skip”.

When you have taken measurements at 8 listening positions, the following screen appears automatically.

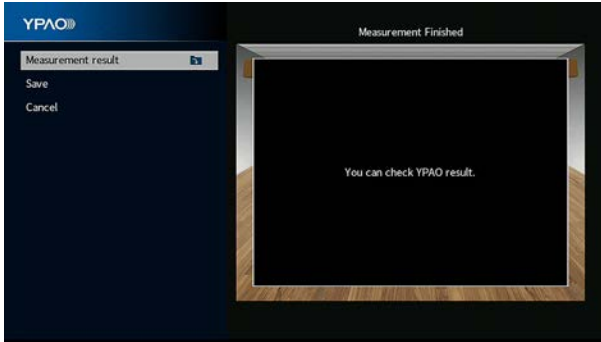

10 Select “Save” to save the measurement result.

The adjusted speaker settings are applied.

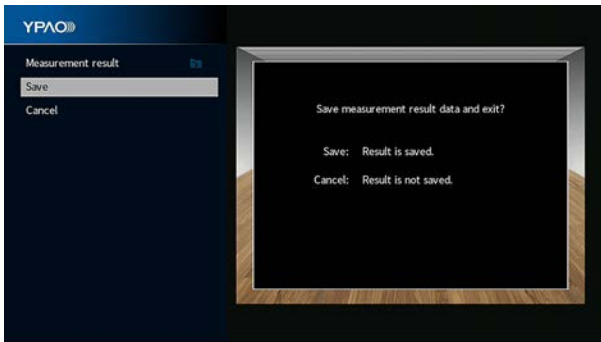

11 Disconnect the YPAO microphone from the unit.

This completes optimization of the speaker settings.

NOTICE

- The YPAO microphone is sensitive to heat, so should not be placed anywhere where it could be exposed to direct sunlight or high temperatures (such as on top of AV equipment).

Configuring the speaker settings automatically based on the YPAO measurement results with the angle/height measurement

Perform the following procedure to take a measurement when the “Angle/Height Measure” option is selected.

NOTE

- Do not use the microphone base until the corresponding message appear on the TV.
- During the measuring process, test tones are output at high volume. You cannot adjust the volume.
- During the measuring process, stay in a back corner of the room and note the following for accurate measurement.
 - Keep the room as quiet as possible.
 - Do not block sound between the speakers and the YPAO microphone.
- Do not connect headphones.
- YPAO multi measurement option cannot be enabled with wireless speakers.
- When Dolby Enabled speakers are used as the presence speakers, the height measurement is not performed.

- 1 Select the unit’s speaker impedance settings as necessary.**
- 2 Configure the corresponding speaker settings.**
- 3 Set the volume of the subwoofer to half. If the crossover frequency is adjustable, set it to maximum.**

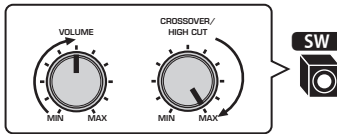

- 4 Place the YPAO microphone at your listening position (same height as your ears).**

We recommend the use of a tripod as a microphone stand and adjust your listening position (same height as your ears). You can use the tripod screws to stabilize the microphone.

5 Connect the YPAO microphone to the YPAO jack.

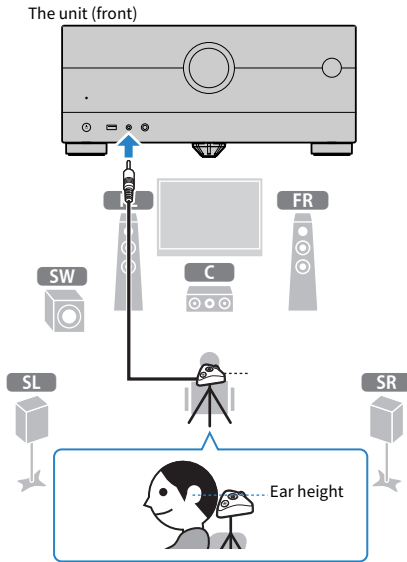

6 Select “Angle/Height Measure” under “Measuring option”.

7 According to the guidance displayed on the screen, start the measurement.

The following screen appears on the TV at the time of angle/height measurement.



8 Attach the supplied pole to the center of the microphone base.

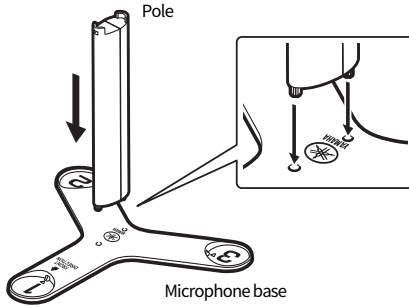

9 Place the microphone base at the listening position (same height as your ears) you will be seated most frequently.

We recommend the use of a tripod and adjust your listening position (same height as your ears). You can use the tripod screws to fix the microphone base.

10 Set the YPAO microphone to the position "1".

Do not move the microphone base until the fourth angle measurement finishes.

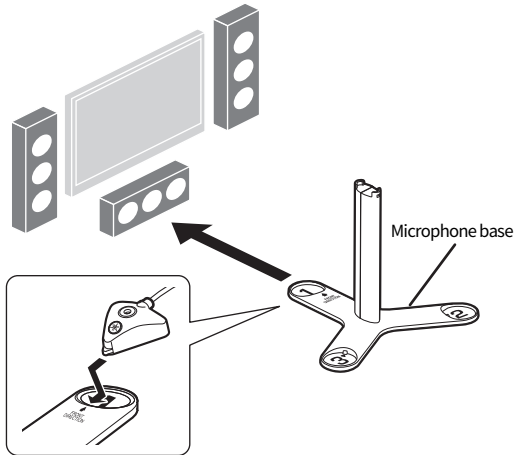

11 Press ENTER to start the first angle measurement.

The following screen appears on the TV when the first angle measurement finishes.

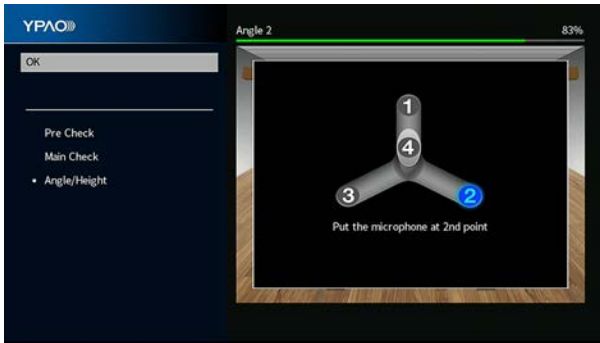

12 In the same way, perform the angle measurement for the positions “2” and “3”.

13 Set the YPAO microphone at the top of the pole and perform the fourth angle measurement.

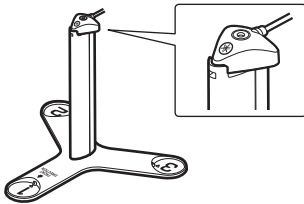

The following screen appears on the TV when the fourth angle measurement finishes.

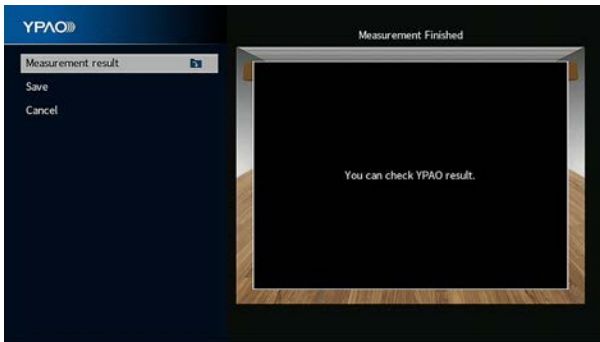

14 Select “Save” to save the measurement result.

The adjusted speaker settings are applied.

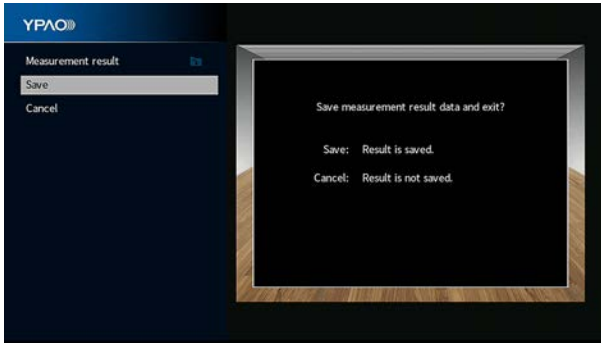

15 Disconnect the YPAO microphone from the unit.

This completes optimization of the speaker settings.

NOTICE

- The YPAO microphone is sensitive to heat, so should not be placed anywhere where it could be exposed to direct sunlight or high temperatures (such as on top of AV equipment).

Error messages from YPAO

If any error message is displayed, resolve the problem by following on-screen instructions and perform YPAO again.

[Search tag]#Q03 YPAO Error

Error message	Remedy
ERROR 1 Front speakers are not detected.	
ERROR 2 One of the surround speakers cannot be detected.	
ERROR 3 One of the front presence speakers cannot be detected.	Exit YPAO, turn off the unit, and then check the speaker connections.
ERROR 4 One of the surround back speakers cannot be detected.	
ERROR 5 The noise is too loud.	Keep the room quiet and retry YPAO. If you select "Proceed", YPAO takes the measurement again and ignores any noise detected.
ERROR 6 Surround back speakers are connected, but no surround speakers are connected.	Surround speakers need to be connected in order to use surround back speakers. Exit YPAO, turn off the unit, and then reconnect the speakers.
ERROR 7 The YPAO microphone has been removed.	Connect the YPAO microphone to the YPAO jack firmly and retry YPAO.
ERROR 8 The YPAO microphone cannot detect test tones.	Connect the YPAO microphone to the YPAO jack firmly and retry YPAO. If this error occurs repeatedly, contact the nearest authorized Yamaha dealer or service center.
ERROR 9 Canceled by user operation	Retry or exit YPAO as necessary.
ERROR 10 An internal error has occurred.	Exit YPAO, and turn off and on the unit. If this error occurs repeatedly, contact the nearest authorized Yamaha dealer or service center.
ERROR 11 One of the rear presence speakers cannot be detected.	Exit YPAO, turn off the unit, and then check the speaker connections.

NOTE

- To exit the YPAO measurement for resolving the problem, select "Quit".
- For the ERROR 5 and ERROR 9 messages only, you can proceed with the current YPAO measurement. Select "Proceed".
- To retry the YPAO measurement from beginning, select "Retry".

Warning messages from YPAO

If a warning message is displayed, resolve the problem by following table and perform YPAO again.

You can still apply the measurement results, however, we recommend you resolve the problem and perform YPAO again in order to use the unit with the optimal speaker settings.

[Search tag]#Q03 YPAO Warning

Warning message	Remedy
<p>WARNING 1 A speaker cable may be connected with the reverse polarity (+/-).</p>	<p>Use the cursor keys to select “Measurement result” and press ENTER, and then select “Wiring” in “Measurement result”. Check the cable connections (+/-) of the speaker identified by “Reverse”.</p> <p>If the speaker is connected incorrectly: Turn off the unit, reconnect the speaker cable.</p> <p>If the speaker is connected correctly: Depending on the type of speakers or room environment, this message may appear even if the speakers are connected correctly. In this case, you can ignore the message.</p>
<p>WARNING 2 A speaker is placed more than 24 m (80 ft) from the listening position.</p>	<p>Use the cursor keys to select “Measurement result” and press ENTER, and then select “Distance” in “Measurement result”. Check the speaker identified by “>24.00m (>80.0ft)”. Exit YPAO, turn off the unit, and place the problem speaker within 24 m (80 ft) of the listening position.</p>
<p>WARNING 3 There are significant volume differences between the speakers.</p>	<p>Check the usage environment and cable connections (+/-) of each speaker, and the volume of the subwoofer. If there is any problem, exit YPAO, turn off the unit, and then reconnect speaker cable or correct the speaker positions. We recommend using the same speakers or speakers with specifications that are as similar as possible.</p>

NOTE

Correct the cable connection or position of the speaker after turning off the unit.

ENJOYING SOUND

Enjoying sound field effects

Selecting your favorite sound mode

The unit is equipped with a variety of sound programs and surround decoders. You can enjoy playback sources with your favorite sound mode such as sound field effect or stereo playback.

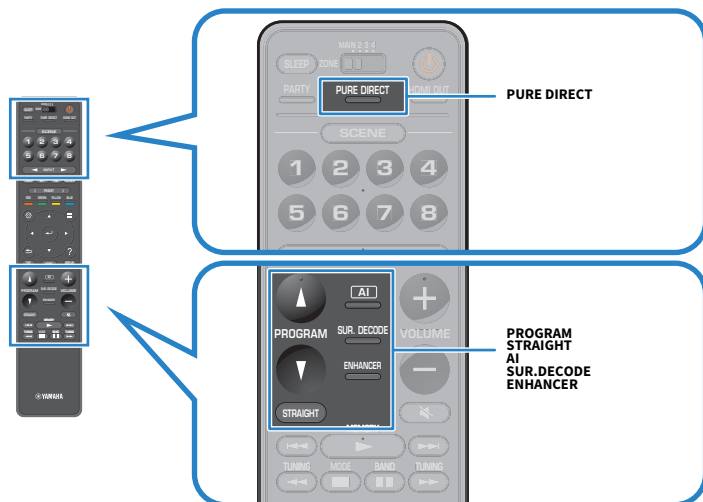

NOTE

The sound mode can be applied separately to each input source.

Related links

- “Playing back with surround effects optimized for the scene (SURROUND:AI)” (p.132)
- “Enjoying sound field effects optimized for the type of content” (p.134)
- “Enjoying multichannel playback without sound field effects (surround decoder)” (p.141)

Playing back with surround effects optimized for the scene (SURROUND:AI)

With SURROUND:AI, the AI incorporated in the DSP creates the optimal surround effect for the scene of the content.

Scenes are instantaneously analyzed with a focus on sound elements such as “dialogue”, “background music”, “ambient sounds” and “sound effects” as well as optimized in real time to create a compelling sense of realism.

Each time you press AI, SURROUND:AI is enabled or disabled.

NOTE

- When Pure Direct is enabled, SURROUND:AI is not available.
- When SURROUND:AI is enabled, the following functions are not available.
 - Straight decode mode
 - CINEMA DSP HD³
 - Surround decoders

Related links

“Enjoying higher quality playback (Pure Direct)” (p.142)

Enjoying 3-dimensional sound fields

The unit is equipped with a variety of sound programs that utilize Yamaha's original DSP technology (CINEMA DSP HD³). It allows you to easily create sound fields like actual movie theaters or concert halls in your room and enjoy natural 3-dimensional sound fields.

NOTE

- You can adjust the effect level of the sound program (enhance or reduce the sound field effect) in "DSP Level" in the "Setup" menu.
- The sound mode can be applied separately to each input source.
- The unit creates front Virtual Presence Speaker (VPS) using the front, center, and surround speakers to produce 3-dimensional sound fields even when no front presence speakers are connected.
- If a multichannel source (6.1 channels or more) is input when no surround back speakers are connected, the unit creates Virtual Surround Back Speaker (VSBS) using the surround speakers to add a sense of depth to the rear sound field.
- The unit creates the virtual processing (Dolby Speaker Virtualization) optimized for Dolby content and multichannel playback when the Dolby Surround decoder is selected.
- This feature does not work on DSD audio until the firmware is updated.

Related links

- "Adjusting the sound field effect level" (p.246)
- "Setting Virtual Presence Speaker (VPS)" (p.261)
- "Setting Virtual Surround Back Speaker (VSBS)" (p.262)
- "Setting Dolby Speaker Virtualization" (p.263)

Enjoying sound field effects optimized for the type of content

The unit is equipped with a variety of sound programs. You can enjoy playback sources with your favorite sound mode. You can select a sound program by pressing PROGRAM.

- We recommend a sound program in the “MOVIE” category displayed on the TV (short messages) and on the front display to enjoy video content.
- We recommend a sound program in the “MUSIC” category displayed on the TV (short messages) and on the front display to enjoy music content.

MUSIC

Hall in Munich	This program simulates a Munich concert hall with approximately 2,500 seats that uses stylish wood for the interior finishing. Fine, beautiful reverberations spread richly, creating a calming atmosphere. The listener’s virtual seat is at the center left of the arena.
Hall in Vienna	This program simulates a 1700-seat, middle-sized concert hall with a shoebox shape that is traditional in Vienna. Pillars and ornate carvings create extremely complex reverberations from all around the audience, producing a very full, rich sound.
Hall in Amsterdam	The large, shoe box shaped hall seats about 2,200 around the circle stage. Reflections are rich and pleasing while the sound travels freely.
Church in Freiburg	Located in the south of Germany, this grand, stone-built church has a pointed tower at 120 meters in height. Its long and narrow shape and the high ceiling enable the elongated reverberation time and limited initial reflection time. Thus, the rich reverberation rather than the sound itself reproduces the atmosphere of the church.
Church in Royaumont	This program features the sound field created by the refectory (dining hall) of a beautiful medieval Gothic monastery located in Royaumont on the outskirts of Paris.
Chamber	This program creates a relatively wide space with a high ceiling, like an audience hall in a palace. It offers pleasant reverberations that are suitable for courtly music and chamber music.
Village Vanguard	The Jazz club is on 7th Avenue, New York. This small club with the low ceiling makes the powerful reflections converge toward the stage located in the center.
Warehouse Loft	The warehouse resembles some lofts in Soho. Sound reflects off the concrete walls clearly with a lot of energy.
Cellar Club	This program simulates an intimate concert venue with a low ceiling and homey atmosphere. A realistic, live sound field delivers powerful sounds that make you feel as if you are sitting in the front row in front of a small stage.
The Roxy Theatre	This program creates the sound field of a 460-seat rock music concert venue in Los Angeles. The listener’s virtual seat is at the center left of the hall.
The Bottom Line	This program creates the sound field at stage front in The Bottom Line, a famous New York jazz club once. The floor can seat 300 people to the left and right in a sound field offering real and vibrant sound.

MOVIE

Sports	This program allows listeners to enjoy the rich vividness of sport broadcasts and light entertainment programs. In sports broadcasts, the commentators’ voices are positioned clearly at the center, while the atmosphere inside the stadium is realistically conveyed by the peripheral delivery of the sounds of the fans in a suitable space.
---------------	--

Action Game	This program is suitable for action games, such as car racing and fighting games. The reality of, and emphasis on, various effects makes the player feel like they are right in the middle of the action, allowing for greater concentration. Use this program in combination with Compressed Music Enhancer for a more dynamic and strong sound field.
Roleplaying Game	This program is suitable for role-playing and adventure games. This program adds depth to the sound field for natural and realistic reproduction of background music, special effects, and dialogue from a wide variety of scenes. Use this program in combination with Compressed Music Enhancer for a clearer and more spatial sound field.
Music Video	This program allows you to enjoy videos of pop, rock, and jazz concerts, as if you were there yourself. Immerse yourself in the hot concert atmosphere thanks to the vividness of the singers and solos on stage, a presence sound field that emphasizes the beat of rhythm instruments, and a surround sound field that reproduces the space of a big live hall.
Recital/Opera	This program controls the amount of reverberations at an optimum level and emphasizes the depth and clarity of human voices to offer the reverberations of an orchestra box in front the listener at the same time as providing the acoustic positioning and feeling of presence on the stage. The surround sound field is relatively moderate, but the data for concert hall effects are used to represent the inherent beauty of music. The listener will not be fatigued even after long hours of opera entertainment.
Standard	This program creates a sound field that emphasizes the surround feeling without disturbing the original acoustic positioning of multichannel audio. Its design is based on the concept of the ideal movie theater, in which the audience is surrounded by beautiful reverberations from the left, right, and rear.
Spectacle	This program delivers the scale and grandeur of spectacular movie productions. It delivers an expansive sound space to match the cinemascope wide-screen, and boasts a broad dynamic range, providing everything from small delicate sounds to powerful loud booms.
Sci-Fi	This program clearly reproduces the finely elaborated sound design of the latest Sci-Fi and SFX movies. You can enjoy a variety of cinematographically created virtual spaces reproduced with clear separation between dialogue, sound effects, and background music.
Adventure	This program is ideal for reproducing the sound design of action and adventure movies precisely. The sound field restrains reverberations, but puts emphasis on reproducing a sensation of expansiveness on both sides, powerful space expanded widely to the left and right. The restrained depth creates a clear and powerful space, while also maintaining the articulation of the sounds and the separation of the channels.
Drama	This program features stable reverberations that match a wide range of movie genres, from serious dramas to musicals and comedies. The reverberations are modest, but suitably stereophonic. The sound effects and background music are reproduced with a gentle echo that does not impinge on the articulation of the dialogue. You'll never get tired listening for long periods.
Mono Movie	This program reproduces monaural video sources, such as classic movies, in an atmosphere of a good old movie theater. The program creates a pleasant space with depth, by adding breadth and the appropriate reverberation to the original audio.
Enhanced	This program creates a sound field that emphasizes the dynamic sound transition of 3D object audio. Its design is based on the concept of a movie theater with multi-top speakers, in which the audience is overwhelmed by the natural and powerful sound effects.
STEREO	
2ch Stereo	Use this program to mix down multichannel sources to 2 channels. When multichannel signals are input, they are down mixed to 2 channels and output from the front speakers (this program does not utilize CINEMA DSP).

All-Channel Stereo

Use this program to output sound from all speakers. When you play back multichannel sources, the unit mixes down the source to 2 channels, and then outputs the sound from all speakers. This program creates a larger sound field and is ideal for background music at parties.

UNPROCESSED

SURROUND DECODE

The surround decoder enables multichannel playback from 2-channel sources without sound field effects.

NOTE

When SURROUND:AI is enabled, you cannot select any sound programs.

Related links

“Adjusting the sound field effect level” (p.246)

Enjoying sound field effects without surround speakers (Virtual CINEMA DSP)

If you select one of the sound programs when no surround speakers are connected, the unit automatically creates the surround sound field using the front speakers. You can enjoy sound field effects without surround speakers.

NOTE

Virtual CINEMA DSP does not work on “2ch Stereo” and “All-Channel Stereo”. Select a sound program besides those.

Related links

“Enjoying sound field effects optimized for the type of content” (p.134)

Enjoying surround sound with 5 speakers placed in front (Virtual CINEMA FRONT)

When the surround speakers are placed in front and “Layout” in “Surround” in the “Setup” menu is set to “Front”, the unit creates the virtual surround speakers in the rear side. You can enjoy multichannel surround sound only with speakers placed in the front.

Related links

- “Setting the layout of the surround speakers” (p.228)
- “Virtual CINEMA FRONT” (p.58)

Enjoying surround sound with headphones (SILENT CINEMA)

You can enjoy surround or sound field effects, like a multichannel speaker system, with stereo headphones by connecting the headphones to the PHONES jack and selecting a sound program or a surround decoder.

SILENT™
CINEMA

Related links

- “Enjoying sound field effects optimized for the type of content” (p.134)
- “Enjoying multichannel playback without sound field effects (surround decoder)” (p.141)

Enjoying unprocessed playback

Enjoying original sound (straight decode)

You can play back input sources without any sound field effects. The unit produces stereo sound from the front speakers for 2-channel sources such as CDs, and produces unprocessed multichannel sounds for multichannel sources.

Each time you press STRAIGHT, the straight decode mode is enabled or disabled.

NOTE

- When surround back speakers are used, the unit produces 7.1-channel sound for 5.1-channel sources.
- If Virtual CINEMA FRONT is set to enable, Virtual CINEMA FRONT works when multichannel source is played back.

Related links

- “Enjoying surround sound with 5 speakers placed in front (Virtual CINEMA FRONT)” (p.138)
- “Setting the layout of the surround speakers” (p.228)

Enjoying multichannel playback without sound field effects (surround decoder)

The unit enables multichannel playback from 2-channel/multichannel sources without sound field effects. This is used when “SURROUND DECODE” is selected by PROGRAM keys.

Press SUR. DECODE to select a surround decoder. Each time you press SUR. DECODE, the surround decoder changes.

Auto	Uses the decoder automatically selected by input source. The DTS Neural:X decoder is selected for DTS sources and the Dolby Surround decoder is selected for other sources. However, the AURO-3D signal sent by DTS-HD is not automatically selected, so you need to manually select “AURO-3D”.
Dolby Surround	Dolby Surround decoder. Expands the sound using a method optimized for the layout of the installed speakers. A real acoustic space (including overhead) will be created especially when object-based audio (such as Dolby Atmos content) is played.
Neural:X	DTS Neural:X decoder. Expands the sound using a method optimized for the layout of the installed speakers. A real acoustic space (including overhead) will be created especially when object-based audio (such as DTS:X content) is played.
AURO-3D	AURO-3D decoder. Expands the sound using a method optimized for the layout of the installed speakers. Be sure to select “AURO-3D” to play AURO-3D.

NOTE

- The selected surround decoder may not work for some input sources.
- We recommend Dolby Surround while network streaming is Dolby content.
- The DTS Neural:X decoder does not work on DTS signals whose sampling frequency is over 48 kHz.
- When the Dolby Surround decoder or the DTS Neural:X decoder is selected, the following virtual processing does not work.
 - Virtual CINEMA FRONT
 - Virtual CINEMA DSP

Related links

- “Enjoying sound field effects without surround speakers (Virtual CINEMA DSP)” (p.137)
- “Enjoying surround sound with 5 speakers placed in front (Virtual CINEMA FRONT)” (p.138)

Enjoying higher quality playback (Pure Direct)

The unit allows you to enjoy the high-quality playback with reduced noise. Various processing modes and some circuitry (such as the front display) other than the basic playback function is suspended.

Each time you press PURE DIRECT, the direct playback mode is enabled or disabled. When the Pure Direct is enabled, "PURE DIRECT" lights up on the front panel.

NOTE

When the Pure Direct is enabled, the following functions are not available.

- Selecting sound programs
- Using the zone function
- Operating the on-screen "Setup" and "Option" menus
- Viewing information on the front display (when not in operation)

Enjoying 3-dimensional sound

Enjoying Dolby Atmos® and DTS:X™

Playing back Dolby Atmos or DTS:X content creates realistic sound that comes from every direction, including overhead. To receive the full effect, we recommend a speaker system with front presence speakers.

About Dolby Atmos®

- Dolby Atmos content is decoded as Dolby TrueHD or Dolby Digital Plus in the following situations. (Dolby Atmos PCM format is always decoded as Dolby Atmos.)
 - Neither surround back nor front presence speakers are used. (When Dolby Speaker Virtualization is enabled, it is decoded as Dolby Atmos.)
 - Headphones are used (2-channel playback).

About DTS:X™

- You can adjust the volume of dialogue sounds in “DTS Dialogue Control” in the “Option” menu.
- When the DTS:X decoder is selected, virtual surround processing does not work.

Related links

- “Speaker systems recommended to the unit (basic setup)” (p.41)
- “5.1.2-channel system” (p.45)
- “Setting Dolby Speaker Virtualization” (p.263)
- “Enjoying surround sound with 5 speakers placed in front (Virtual CINEMA FRONT)” (p.138)
- “Enjoying sound field effects without surround speakers (Virtual CINEMA DSP)” (p.137)
- “Adjusting the volume of dialogue sound during DTS:X™ playback” (p.198)

Enjoying AURO-3D®

AURO-3D provides an immersive and natural “vertical sound field” through its unique speaker-placement structure that surrounds listeners. To get the most from your AURO-3D speakers, follow the next instructions for speaker installation and setup.

■ Installing front and rear presence speakers (recommendation)

In addition to a standard 5.1-channel or 7.1-channel speaker system, install front and rear presence speakers (p.41).

NOTE

- To get the maximum effect from AURO-3D, it is recommended to install the presence speakers on the walls in both the front and rear (according to the Auro Technologies company’s recommended setup). However, AURO-3D can also be played if the speakers are installed on the ceiling or if Dolby Enabled speakers are used.
- AURO-3D can also be played even if only front presence speakers are installed.
- In the case of a 2-channel to 7.1-channel speaker system (without presence speakers), playback will be by Auro Surround with Auro-Matic upmix.

■ Selecting a Surround Decoder

To play AURO-3D, you need to manually set the surround decoder to “AURO-3D” (p.141).

NOTE

AURO-3D playback of the AURO-3D signal sent by PCM is also possible when the surround decoder setting is “Auto”.

■ Setting the AURO-3D Decoder

Use the “Setup” menu to configure each setting for the AURO-3D decoder (p.248).

■ Playing back AURO-3D content

Play AURO-3D compatible Blu-ray discs on an HDMI-connected BD player.

“AURO-3D” is recommended as the “AURO-3D Listening Mode” setting (p.248).

NOTE

CINEMA DSP cannot be used at the same time when playing AURO-3D.

Related links

- “Speaker systems recommended to the unit (basic setup)” (p.41)
- “Presence speaker layout” (p.420)

Enjoying favorite sound

Enjoying more powerful sound to the audio source (Compressed Music Enhancer)

You can enjoy a dynamic sound by adding depth and breadth to the sound. This function can be used along with any other sound modes.

For digitally compressed formats, you can play back an enriched sound close to the original sound before it was compressed.

Each time you press ENHANCER, Compressed Music Enhancer is enabled or disabled.

NOTE

- Compressed Music Enhancer does not work on the following audio sources.
 - Signals whose sampling frequency is over 48 kHz
 - DSD audio
- You can also use “Enhancer” in the “Option” menu to enable Compressed Music Enhancer.
- Compressed Music Enhancer enhances the quality of 2-channel uncompressed digital audio (such as PCM) and lossless compressed digital audio (such as FLAC) when “Hi-Res Mode” in the “Option” menu is set to “On”.

Related links

- “Setting Compressed Music Enhancer” (p.201)
- “Setting the high-resolution mode” (p.202)

Enhancing the low-frequency range from the subwoofer

You can enhance the low-frequency range from the subwoofer while avoiding interference with the front speakers in middle- and low-frequency range.

Set “Subwoofer Trim” in the “Option” menu.

Related links

[“Adjusting the subwoofer volume” \(p.204\)](#)

Enjoying powerful sound at low volume

Automatically you can correct the high- and low-frequency levels, hardly heard at low volume, based on the YPAO measurement results and the auditory sensation.

Set “YPAO Volume” in the “Option” menu.

NOTE

- “YPAO Volume” works after the YPAO measurement.
- “YPAO Volume” is automatically enabled after the YPAO measurement.

Related links

“Adjusting the high- and low-frequency levels automatically according to the volume” (p.195)

Making easy to hear the dialogue sounds

You can adjust the volume of dialogue sounds to become easy to hear.

Set “Dialogue Level” in the “Option” menu.

Related links

“Adjusting the volume of dialogue sound” (p.197)

Enjoying bass sound with small speakers (Extra Bass)

You can enjoy sufficient bass sound, regardless of the size of the front speakers and the presence or absence of a subwoofer.

Set “Extra Bass” in the “Option” menu.

Related links

[“Setting the use of Extra Bass” \(p.205\)](#)

Enjoying sound better

Enjoying music streaming services

● **You can listen to better sound in music streaming services.**

Set Compressed Music Enhancer to “On”. For details, see the following:

- “Enjoying more powerful sound to the audio source (Compressed Music Enhancer)” (p.145)

Enjoying sound at a low volume at night

● **Sound at a low volume is hard to listen to.**

Set “Adaptive DRC” to “On”. For details, see the following:

- “Adjusting the dynamic range automatically” (p.196)

Enjoying the sound of voices

● **Dialogue sound is hard to listen to.**

Adjust “Dialogue Level”. For details, see the following:

- “Adjusting the volume of dialogue sound” (p.197)

● **Voices may not be heard beautifully.**

Set Compressed Music Enhancer to “On”. For details, see the following:

- “Enjoying more powerful sound to the audio source (Compressed Music Enhancer)” (p.145)

If voices may not be still heard beautifully, adjust the perceived height of dialogue sounds to higher position. For details, see the following:

- “Adjusting the perceived height of dialogue sound” (p.199)

Enjoying surround sound without speakers in the back of the room

● **In 5.1-channel system, speakers cannot be placed in the back of the room.**

Using “Virtual CINEMA FRONT”, the unit creates the virtual surround speakers in the rear side. For details, see the following:

- “Enjoying surround sound with 5 speakers placed in front (Virtual CINEMA FRONT)” (p.138)

● **Speaker system is 3.1-channel or less.**

Virtual CINEMA DSP automatically creates the surround sound field using the front speakers. For details, see the following:

- “Enjoying sound field effects without surround speakers (Virtual CINEMA DSP)” (p.137)

● **You can enjoy sound with headphones.**

SILENT CINEMA creates the surround or sound field effects, like a multichannel speaker system, with stereo headphones. For details, see the following:

- “Enjoying surround sound with headphones (SILENT CINEMA)” (p.139)

PLAYBACK

Basic playback procedure

Basic procedure for playing back video and music

Basic procedure for playing back video and music is as follows.

- 1 Turn on the external devices.**
- 2 Use the input selection keys to select an input source.**

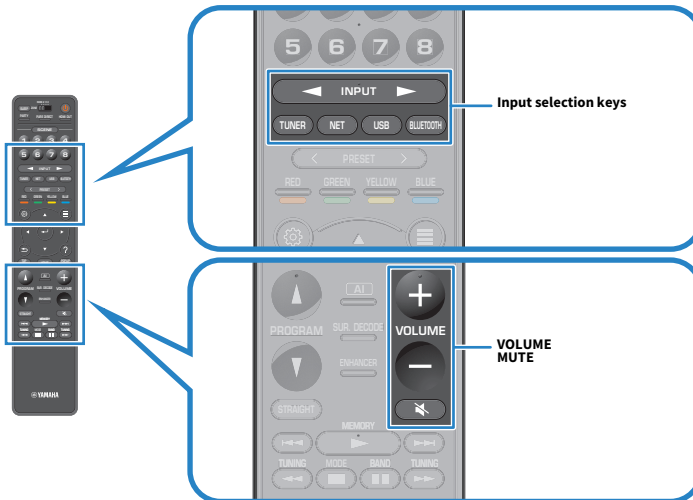

- 3 Start playback on the external device or select a radio station.**
- 4 Press VOLUME to adjust the volume.**

NOTE

- To mute the audio output, press MUTE. Press MUTE again to unmute.
- Refer to the instruction manual for the external device.

Selecting an HDMI output jack

You can select the HDMI OUT jacks for video/audio output. Each time you press HDMI OUT, the HDMI OUT jack to be used for signal output changes.



HDMI OUT 1 2	Outputs the same signal at both the HDMI OUT 1 and HDMI OUT 2 jacks.
HDMI OUT 1 2	Outputs the signals at the HDMI OUT 1 jack.
HDMI OUT 1 2	Outputs the signals at the HDMI OUT 2 jack.
HDMI OUT 1 2	Does not output the signals at the HDMI OUT 1 or HDMI OUT 2 jacks.

NOTE

- You can also select an HDMI output jack by selecting a scene.
- When “HDMI OUT 1 2” is selected, the unit outputs video signals at the highest resolution supported by both TVs (or projectors) connected to the unit. (For example, if you have connected a 1080p TV to the HDMI OUT 1 jack and a 720p TV to the HDMI OUT 2 jack, the unit outputs 720p video signals.)

Related links

“Selecting the input source and favorite settings with one touch (SCENE)” (p.175)

Item names and functions of the playback screen

When playback starts, the playback screen appears on the TV.

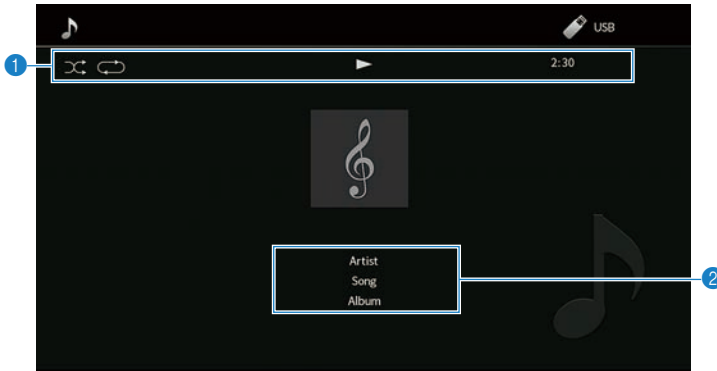

1 Status indicators

Display the current shuffle/repeat settings and playback status (such as play/pause).

2 Playback information

Displays the artist name, album name, song title, track number, station name, and elapsed time.

NOTE

- Displayed items vary depending on the content of playback.
- Using the external device operation keys on the remote control, you can perform playback operations. Note that the playback operations may not work for some input sources or external devices.
- When "SERVER", "NET RADIO" or "USB" is selected for the input source, press RETURN on the remote control to display the browse screen.
- When "Video Out" in the "Option" menu is set to except "Off", the video input through the corresponding video input jack is displayed on the TV. You can display the playback screen on the TV by pressing any cursor key, and also close it by pressing the left cursor key. The playback screen will be closed automatically without operations for one minute.

Related links

"Selecting a video source to be displayed with the selected audio source" (p.208)

Item names and functions of the browse screen

When the following input source is selected, the browse screen appears on the TV.

- SERVER
- NET RADIO
- USB

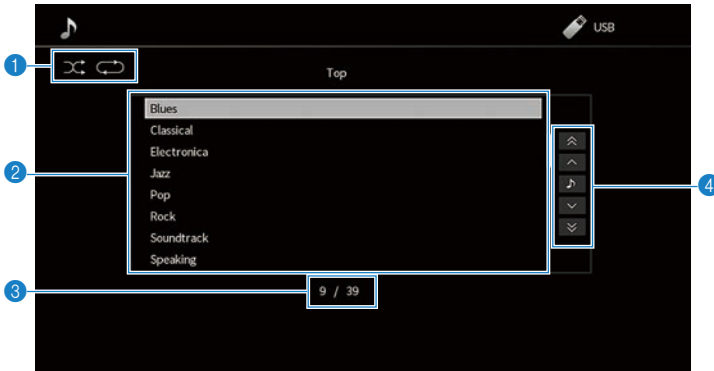

1 Status indicators

Display the current shuffle/repeat settings.





2 Contents list

Displays the list of contents. Select an item and press ENTER to confirm the selection.

3 Item number/total

4 Operation menu

Select an item and press ENTER to confirm the selection.

Icon	Function
	Moves 10 pages of the list.
	
	Moves one page of the list.
	
	Moves to the playback screen.

NOTE

- Displayed items vary depending on the input source.
- When "Video Out" in the "Option" menu is set to except "Off", the video input through the corresponding video input jack is displayed on the TV. You can display the browse screen on the TV by pressing any cursor key, and also close it by pressing the left cursor key. The browse screen will be closed automatically without operations for one minute.
- The music content delivered from streaming services can be operated by using MusicCast Controller on your mobile device.

Related links

"Selecting a video source to be displayed with the selected audio source" (p.208)

Playing back TV audio

Playback of TV audio with eARC/ARC

Connect your TV that supports eARC/ARC to the unit with an HDMI cable to play back the TV audio on the unit.

When you select a TV program with the TV remote control, the input source of the unit will be automatically switched to “TV” and the TV audio will be played back on the unit.

NOTE

- When using eARC, you may set the HDMI Control to “Off”. But the input source of the unit will not be automatically switched to “TV” when you select a TV program with the TV remote control. The input source must be manually switched to “TV” to play back the TV audio.
- When using ARC, set the HDMI Control and ARC function to “On”.
- You may need setting on the TV. Refer to the instruction manual for the TV.
- If your TV does not support eARC/ARC or the audio is interrupted while using eARC/ARC, use a digital optical cable to input TV audio to the unit.

Related links

- “HDMI connection with a TV” (p.89)
- “Setting the use of HDMI Control” (p.275)
- “Setting the use of ARC” (p.276)
- “Playback of TV audio with a digital optical cable” (p.156)

Playback of TV audio with a digital optical cable

In the following case, use a digital optical cable to input TV audio to the unit.

- Your TV does not support eARC/ARC.
- You do not want to use eARC/ARC.

1 Set “ARC” in the “Setup” menu to “Off”.

2 Select a video content (a TV program) with the TV remote control.

The input source of the unit is automatically switched to “TV” and the TV audio will be played back on the unit.

NOTE

- When you play back TV audio with a digital optical cable connected to the OPTICAL jack except AUDIO 1, set “TV Audio Input” in the “Setup” menu.
- When you play back TV audio with a cable other than a digital optical cable, set “TV Audio Input” in the “Setup” menu.
- When you set the HDMI Control to “Off”, switch the input source to “TV” manually, and then, select a video content (a TV program) with the TV remote control.

Related links

- “HDMI connection with a TV” (p.89)
- “Setting the use of ARC” (p.276)
- “Setting the audio input jack used for TV audio” (p.314)

Listening to the radio

Preparing to listen to the radio

Setting the frequency steps

Model For

Asia, Taiwan, Brazil, General, and Central and South America

Set the radio tuning frequency steps of the unit depending on your country or region.

At the factory, the frequency step setting is set to 50 kHz for FM and 9 kHz for AM. Depending on your country or region, set the frequency steps to 100 kHz for FM and 10 kHz for AM.

- 1 Press SETUP.**
- 2 Select “System”.**
- 3 Select “Tuner”.**
- 4 Select “FM100/AM10”.**
- 5 Press SETUP.**

This completes the settings.

NOTE

Preset (registered radio stations) and frequency will be initialized if you change the radio tuning frequency steps.

Preparing the DAB tuning

Model For

U.K., Europe, Russia and Australia

Before listening to DAB (Digital Audio Broadcasting) radio, perform an initial scan to register the DAB radio stations automatically.

1 Select “TUNER” as the input source.

2 Press BAND to select the DAB band.

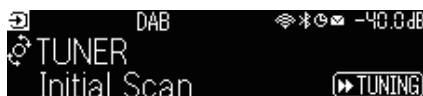

3 Press [▶▶ TUNING] to start an initial scan.

When the initial scan finishes, the unit automatically tunes in to the first DAB radio station in order by frequency.

NOTE

- DAB uses digital signals for clearer sound and more stable reception compared to analog signals. The unit can also receive DAB+ (an upgraded version of DAB) that allows for more stations using MPEG-4 HE-AAC v2 audio codec, which has a more efficient transmission method.
- Be sure to check the DAB coverage in your area in that not all areas are currently being covered. For a list of nationwide DAB statuses and worldwide DAB frequencies, check WorldDMB online at <http://www.worlddab.org/>.
- If no DAB radio stations are found by an initial scan, the front display will change to the initial Scan menu. Press [▶▶ TUNING] to start an initial scan again.
- You can check reception strength of each DAB channel label. Press MODE two times to view the Tune AID menu. Then, select the desired DAB channel label. The reception strength of DAB channel label is displayed in 0 (none) to 100 (best).
- To perform an initial scan again after some DAB radio stations are stored, press MODE. If you perform an initial scan again, the DAB radio stations currently registered to the preset numbers will be cleared.

■ DAB frequency information

The unit supports Band III (174 to 240 MHz) only.

Frequency	Channel label
174.928 MHz	5A
176.640 MHz	5B
178.352 MHz	5C
180.064 MHz	5D
181.936 MHz	6A
183.648 MHz	6B
185.360 MHz	6C
187.072 MHz	6D
188.928 MHz	7A

PLAYBACK > Listening to the radio

Frequency	Channel label
190.640 MHz	7B
192.352 MHz	7C
194.064 MHz	7D
195.936 MHz	8A
197.648 MHz	8B
199.360 MHz	8C
201.072 MHz	8D
202.928 MHz	9A
204.640 MHz	9B
206.352 MHz	9C
208.064 MHz	9D
209.936 MHz	10A
211.648 MHz	10B
213.360 MHz	10C
215.072 MHz	10D
216.928 MHz	11A
218.640 MHz	11B
220.352 MHz	11C
222.064 MHz	11D
223.936 MHz	12A
225.648 MHz	12B
227.360 MHz	12C
229.072 MHz	12D
230.784 MHz	13A
232.496 MHz	13B
234.208 MHz	13C
235.776 MHz	13D
237.488 MHz	13E
239.200 MHz	13F

Listening to the radio

You can tune in to a radio station by using the unit's built-in tuner.

1 Select "TUNER" as the input source.

"TUNER" is selected as the input source and the frequency currently selected is displayed on the front display.



"TUNED" lights up on the front display when the unit is receiving a radio station signal. Also, "STEREO" lights up when receiving a stereo radio signal.

2 Press BAND to select the following band.

- FM/AM (Except for U.K., Europe, Russia and Australia models)
- DAB/FM (U.K., Europe, Russia and Australia models)

3 Select a radio station.

- Press TUNING repeatedly to select a frequency for reception.
Hold down TUNING for about a second to search stations automatically.
- Press PRESET to select a registered radio station.

NOTE

- To switch between stereo and monaural for FM radio reception, press MODE. When the signal reception for an FM radio station is unstable, switching to monaural may improve it. Even when you switch to stereo, "STEREO" does not light up on the front display if the unit is not receiving a stereo radio signal.
- You can watch videos input from external devices while listening to radio.
- You can check reception strength of each DAB channel label.

Related links

- "Registering a radio station manually" (p.163)
- "Selecting a video source to be displayed with the selected audio source" (p.208)

Displaying the Radio Data System information

Model For

U.K., Europe and Russia

Radio Data System is a data transmission system used by FM stations. The unit can receive various types of data, such as “Program Service”, “Program Type”, “Radio Text” and “Clock Time”, when it is tuned in to a Radio Data System broadcasting station.

Reception	Frequency
Program Service	Program service name
Program Type	Current program type
Radio Text	Information on the current program
Clock Time	Current time
DSP Program	Sound mode name
Audio Decoder	Decoder name
Output CH	Sound outputting speakers
HDMI Status	HDMI jacks information (connection etc.)
Zone Status	Zone information (enabled or disabled)
System Status	System information (eco mode etc.)

NOTE

- “---” is displayed in “Program Service”, “Program Type”, “Radio Text”, and “Clock Time” if the radio station does not provide the Radio Data System service.
- We recommend using “Auto Preset” to tune in to the Radio Data System broadcasting stations.

Related links

“Registering FM radio stations automatically (Auto Preset)” (p.164)

Displaying the DAB information

Model For

U.K., Europe, Russia and Australia

The unit can receive various types of DAB information when it is tuned into a DAB radio station.

- 1 Tune in to the desired DAB radio station.**
- 2 Push and rotate SELECT/ENTER on the front panel to select between the various display items.**

The information appears on the front display.

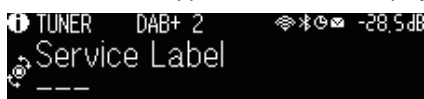

Service Label	Station name
Dynamic Label	Information on the current station
Ensemble Label	Ensemble name
Program Type	Station genre
Date and Time	Current date and time
Audio Mode	Audio mode (monaural/stereo) and bit rate
CH Label/Frequency	Channel label and frequency
Signal Quality	Signal reception quality (0 [none] to 100 [best])
DSP Program	Sound mode name
Audio Decoder	Decoder name
Output CH	Sound outputting speakers
HDMI Status	HDMI jacks information (connection etc.)
Zone Status	Zone information (enabled or disabled)
System Status	System information (eco mode etc.)

NOTE

Some information may not be available depending on the selected DAB radio station.

Registering a radio station manually

Tune in to a radio station and register it to a preset number.

- 1 Tune in to the desired radio station.**
- 2 Hold down MEMORY for 3 seconds.**
- 3 Press PRESET to select the preset number.**

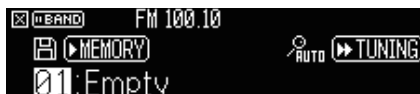

- 4 Press MEMORY.**



This completes the registration.

NOTE

- You can register up to 40 radio stations as presets.
- Hold down MEMORY for 5 seconds after tuning in to the desired radio station so that you can register it to the next empty (unused) preset number after the most recently registered number.
- To cancel the registration, press BAND.
- The front display returns to the input select mode automatically without operations for 30 seconds.

Related links

- “Listening to the radio” (p.160)
- “Registering FM radio stations automatically (Auto Preset)” (p.164)

Registering FM radio stations automatically (Auto Preset)

You can register FM radio stations automatically. FM radio stations with strong signals are automatically registered to the preset numbers.

- 1 Select the FM band.**
- 2 Hold down MEMORY for 3 seconds.**

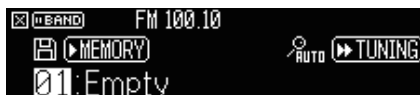

- 3 Press PRESET to select the preset number from which to start the registration.**
- 4 Press [▶▶ TUNING].**

The Auto Preset process starts.



NOTE

- You can register up to 40 radio stations as presets.
- To cancel the Auto Preset process, press BAND.
- (U.K., Europe and Russia models only)
Only Radio Data System broadcasting stations are registered automatically by the Auto Preset function.

Related links

- "Listening to the radio" (p.160)
- "Registering a radio station manually" (p.163)

Clearing preset stations

Clears radio stations registered to the preset numbers.

1 Select “TUNER” as the input source.

2 Hold down MEMORY for 3 seconds.

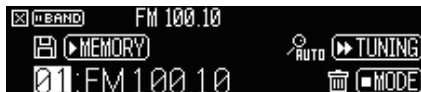

3 Press PRESET to select a preset station to be cleared.

4 Press MODE.

The preset station is cleared.

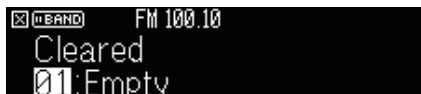

5 Repeat steps 3 to 4 until all desired preset stations are cleared.

6 Press BAND.

The front display returns to the input select mode.

Playing back music with the Bluetooth® connection

Playback of Bluetooth® device music on the unit

You can play back music files stored on a Bluetooth device (such as smartphones) on the unit.



CAUTION

- When you use Bluetooth device controls to adjust volume, the volume may be unexpectedly loud, and it could result in difficulty in hearing or damage to devices. If the volume suddenly increases during playback, stop playback immediately.

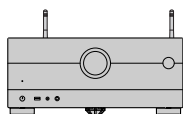

The unit



Bluetooth device
(such as smartphones)

1 Select “Bluetooth” as the input source.

2 On the Bluetooth device, select the unit (network name of the unit).

If the pass key is required, enter the number “0000”.

3 On the Bluetooth device, start playback.

The playback screen is displayed on the TV.

NOTE

- If the unit detects the Bluetooth device previously connected, the unit automatically connects to it. To establish another Bluetooth connection, first terminate the current Bluetooth connection.
- You can adjust the unit’s volume from the Bluetooth device during playback.
- To terminate the Bluetooth connection, perform one of the following operations.
 - Perform the disconnect operation on the Bluetooth device.
 - Select an input source other than “Bluetooth” on the unit.
 - Select “Disconnect” in “Audio Receive” in the “Setup” menu.
- The Bluetooth indicator on the front display lights up while the unit is connected to a Bluetooth device.

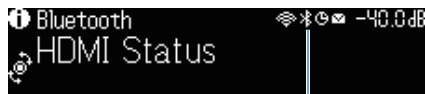

Indicator

Related links

- “Setting the use of Bluetooth®” (p.293)
- “Item names and functions of the playback screen” (p.153)
- “Terminating the connection between a Bluetooth® device and the unit” (p.294)
- “Setting the use of volume control via Bluetooth” (p.296)

Playback of music using Bluetooth® speakers/headphones

You can enjoy audio played back on the unit using Bluetooth speakers/headphones.

Be sure to connect the Bluetooth speakers/headphones whose volume is adjustable. You cannot adjust the volume of the Bluetooth speakers/headphones from the unit.

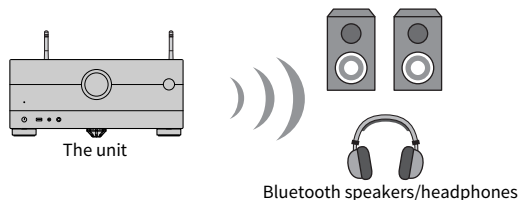

- 1 Select an input source other than “Bluetooth”.**
- 2 Press SETUP.**
- 3 Set “Transmitter” in “Bluetooth” in the “Setup” menu to “On”.**
- 4 Select the Bluetooth speakers/headphones in “Device Search” in the “Setup” menu.**

When the connection process finishes, “Completed” appears and audio played back on the unit will be reproduced from the Bluetooth speakers/headphones.

NOTE

- Use the Bluetooth speakers/headphones to adjust their volume.
- Sounds will be also output from the speakers connected to the unit.
- AirPlay and DSD audio cannot be delivered.
- You cannot use the Bluetooth audio transmitter function and the Bluetooth audio receiver function at the same time.
- If the desired Bluetooth device is not displayed on the list, set the Bluetooth device to the pairing mode and then perform “Device Search” operation again.
- To terminate the Bluetooth connection, perform one of the following operations.
 - Perform the disconnect operation on the Bluetooth speakers/headphones.
 - Set “Transmitter” in “Bluetooth” in the “Setup” menu to “Off”.
- The Bluetooth indicator on the front display lights up while the unit is connected to a Bluetooth device.

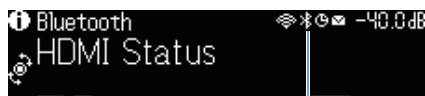

Indicator

Related links

- “Setting the use of Bluetooth®” (p.293)
- “Setting the use of audio transmission to a Bluetooth® device” (p.297)
- “Connecting the unit to a Bluetooth® device that receives transmitted audio” (p.298)

Playing back music with AirPlay

Playback of music with AirPlay

The AirPlay allows you to play back music on the unit. Tap (Click) the AirPlay icon on your iPhone or iTunes/ music and select the unit as the audio output device.



CAUTION

- When you use AirPlay device controls to adjust volume, the volume may be unexpectedly loud, and it could result in difficulty in hearing or damage to devices. If the volume suddenly increases during playback, stop playback immediately.

NOTE

- You can turn on the unit automatically when starting playback on the AirPlay device.
- You can edit the network name (the unit's name on the network) displayed on the AirPlay device.
- You can adjust the unit's volume from the AirPlay device during playback.
- The unit supports AirPlay 2.
- Refer to the website of Apple Inc. about AirPlay.

Related links

- "Setting the use of the Network Standby function" (p.288)
- "Setting the network name of the unit" (p.291)
- "Setting the use of volume control via AirPlay" (p.290)

Playing back music stored on a USB flash drive

Playback of USB flash drive content

You can play back music files stored on a USB flash drive on the unit.

1 Connect the USB flash drive to the USB jack.

The unit (front)

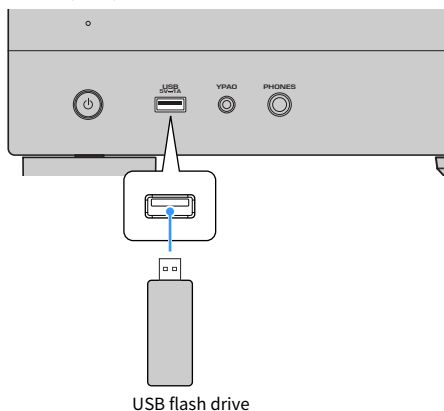

2 Select “USB” as the input source.

The browse screen is displayed on the TV. If playback is ongoing on your USB flash drive, the playback screen is displayed.

3 Select an item.

Playback starts and the playback screen is displayed.

NOTE

- To return to the top level while on the browse screen, hold down RETURN on the remote control.
- If the USB flash drive contains many files, it may take time to load them.
- The maximum limits of playback are 500 music files. The folder structure of your USB flash drive may reduce the maximum limits.
- Stop playback of the USB flash drive before disconnecting it from the USB jack.
- Connect a USB flash drive directly to the USB jack of the unit. Do not use extension cables.
- The unit does not supply power to the USB flash drive while it is in standby mode.
- You can configure the shuffle/repeat settings for playback of contents.
- You can register contents as shortcuts and access them directly.
- When you connect a USB flash drive to the USB jack on the unit for the first time, the unit starts automatically to play back the content at the head of the top-level folder (root folder) on the USB flash drive.

Related links

- “Item names and functions of the browse screen” (p.154)
- “Item names and functions of the playback screen” (p.153)
- “Configuring the shuffle setting” (p.209)
- “Configuring the repeat setting” (p.210)
- “Registering a favorite content as shortcut” (p.179)

Playing back music stored on media servers (PCs/NAS)

Playback of music media servers (PCs/NAS)

You can play back music files stored on your media server on the unit.

NOTE

You need to configure the media sharing setting on each device or media server software in advance. For details, refer to the instruction manual for the device or software.

1 Select “SERVER” as the input source.

The browse screen is displayed on the TV. If playback of a music file selected from the unit is ongoing on your media server, the playback screen is displayed.

2 Select a media server.

3 Select an item.

Playback starts and the playback screen is displayed.

NOTE

- Press NET repeatedly to select the input source.
- To return to the top level while on the browse screen, hold down RETURN on the remote control.
- If the audio is interrupted while using the wireless network connection, use the wired network connection.
- You can configure the shuffle/repeat settings for playback of contents.
- You can also use the Digital Media Controller (DMC) to control playback.
- You can register contents as shortcuts and access them directly

Related links

- “Item names and functions of the browse screen” (p.154)
- “Item names and functions of the playback screen” (p.153)
- “Configuring the shuffle setting” (p.209)
- “Configuring the repeat setting” (p.210)
- “Setting the use of a Digital Media Controller” (p.289)
- “Registering a favorite content as shortcut” (p.179)

Listening to Internet radio

Selecting an Internet radio station

Select an Internet radio station and start playback.

1 Select “NET RADIO” as the input source.

The browse screen is displayed on the TV.

2 Select an item.

Playback starts and the playback screen is displayed.

NOTE

- Press NET repeatedly to select the input source.
- To return to the top level while on the browse screen, hold down RETURN on the remote control.
- You may not be able to receive some Internet radio stations.
- The unit uses the airable.Radio service. airable is a service of airable GmbH.
- Service may change or be discontinued without notice. We ask for your understanding in advance that Yamaha Corporation would not bear any liability for it.

Related links

- “Adding a “NET RADIO” radio station to the “Favorites” folder” (p.211)
- “Item names and functions of the browse screen” (p.154)
- “Item names and functions of the playback screen” (p.153)

Listening to music streaming services

Listening to a music streaming service

You can enjoy the music content delivered from streaming services.

For details on supported music streaming services, refer to products information of the Yamaha website or the MusicCast Controller app.

Additional information of music streaming services is also carried in the following website.

<https://manual.yamaha.com/av/mc/ss/>

NOTE

- You need a pay application in some streaming services. For details, refer to the service provider's website.
- Service may change or be discontinued without notice. We ask for your understanding in advance that Yamaha Corporation would not bear any liability for it.

Related links

- "Checking the network information of the unit" (p.284)
- "Adding the unit to the MusicCast network" (p.112)

USEFUL FUNCTIONS

Sleep timer function

Setting the time of the sleep timer

The unit switches to the standby mode after set time passes. Press SLEEP repeatedly to set the time of the sleep timer (120 min, 90 min, 60 min, 30 min, off). When the sleep timer is on, the sleep timer indicator lights up on the front display.

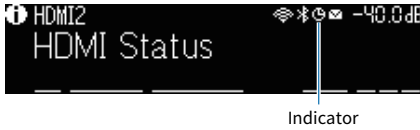

SCENE function

Selecting the input source and favorite settings with one touch (SCENE)

The SCENE function allows you to select the input source and settings registered to the corresponding scene with just one touch. The settings which can be registered are as follows.

[Search tag]#Q04 SCENE

- HDMI Control
- Input
- Registered Content
- HDMI Output/Dimmer
- Mode
- Sound
- Surround
- Video
- Volume
- Lipsync
- Speaker Setup
- Zone Interlock

Related links

- “Selecting a registered scene” (p.176)
- “Registering a scene” (p.178)

Selecting a registered scene

Press a SCENE number key on the remote control, and the settings registered to the corresponding scene are directly selected. Alternatively, you can also select a registered scene by pressing SCENE switching key repeatedly. The unit turns on automatically when it is in standby mode.

[Search tag]#Q04 SCENE

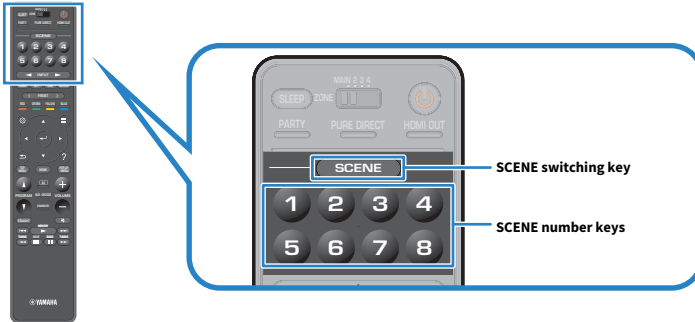

NOTE

- You can also select a registered scene 1 to 4 by touching SCENE (4 numbers) on the front panel.
- The SCENE function can be selected for each zone. Set the zone switch to the zone for which you want to select a registered scene and press a numbered key or press SCENE keys repeatedly.

By default, the following input source is registered for each SCENE number key. You can also check other registered settings in “Scene Setting” in the “Setup” menu.

Main zone

- SCENE number key 1: HDMI1
- SCENE number key 2: TUNER
- SCENE number key 3: AUDIO2
- SCENE number key 4: NET RADIO
- SCENE number key 5: HDMI2
- SCENE number key 6: HDMI3
- SCENE number key 7: TV
- SCENE number key 8: SERVER

Zone2/Zone3

- SCENE number key 1: AUDIO1
- SCENE number key 2: TUNER
- SCENE number key 3: AUDIO2
- SCENE number key 4: NET RADIO
- SCENE number key 5: AUDIO3

USEFUL FUNCTIONS > SCENE function

SCENE number key 6: AUDIO1

SCENE number key 7: AUDIO1

SCENE number key 8: SERVER

Zone4

SCENE number key 1: HDMI1

SCENE number key 2: HDMI2

SCENE number key 3: HDMI3

SCENE number key 4: HDMI4

SCENE number key 5: HDMI5

SCENE number key 6: HDMI6

SCENE number key 7: HDMI7

SCENE number key 8: HDMI1

Related links

“Selecting items to be included as the scene assignments” (p.268)

Registering a scene

You can change the default setting assigned to each SCENE number key. When “NET”, “USB” or “TUNER” is selected for the input source, you can register the assigned radio station or content.

[Search tag]#Q04 SCENE

- 1 Prepare the unit’s settings you want to assign to a SCENE number key.**
- 2 Hold down the desired SCENE number key on the remote control until the following message appears.**

On the front display/TV: Setting Complete

This completes the registers.

NOTE

- We recommend registering the scene while playing back the content that you want to register.
- You can change the SCENE name displayed on the front display or on the TV.
- You can configure more detailed scene assignments in “Scene Setting” in the “Setup” menu.
- The SCENE function can be registered in each zone. Set the zone switch to the zone in which you want to register a scene.
- To use HDMI Control and synchronized operations, you need to configure the HDMI settings on the unit.

Related links

- “Selecting items to be included as the scene assignments” (p.268)
- “Renaming the SCENE name” (p.269)
- “Setting the use of HDMI Control” (p.275)
- “Turning on/off the power of zones” (p.187)

Shortcut function

Registering a favorite content as shortcut

You can register favorite content (such as music stored on media servers and Internet radio stations) as shortcuts.

1 Play back a song or a radio station to be registered.

2 Hold down MEMORY for 3 seconds.

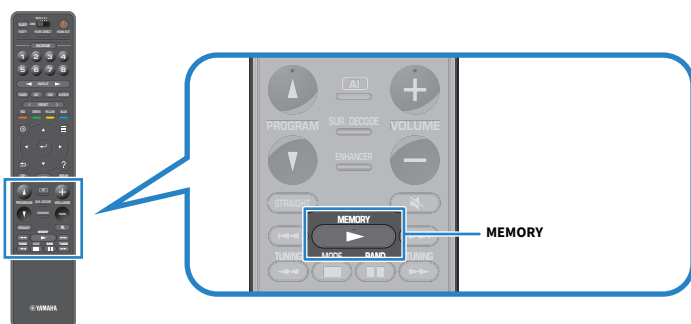

“MEMORY”, the shortcut number to which the content will be registered, and “Empty” appear on the front display.

3 Press MEMORY.

The registered shortcut number and “Memorized” appear on the front display.

This completes the registers.

NOTE

- To set a shortcut number to which the content will be registered, use PRESET to select the shortcut number.
- You can register up to 40 kinds of content as shortcuts.
- You can also use the “Favorites” feature to register the currently playing Internet radio station when you select “NET RADIO” as the input source.
- The unit registers Bluetooth or AirPlay as an input source. No individual content can be registered.

Related links

“Adding a “NET RADIO” radio station to the “Favorites” folder” (p.211)

Recalling a registered content as shortcut

Recall a registered content (such as music stored on media servers and Internet radio stations) by selecting the shortcut number.

1 Press **BLUETOOTH**, **NET** or **USB**.

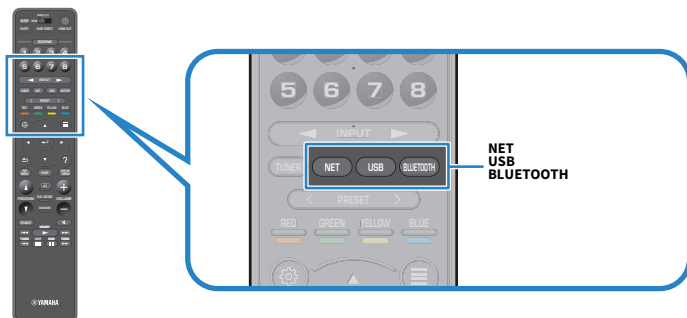

2 Press **PRESET** to select a desired content.

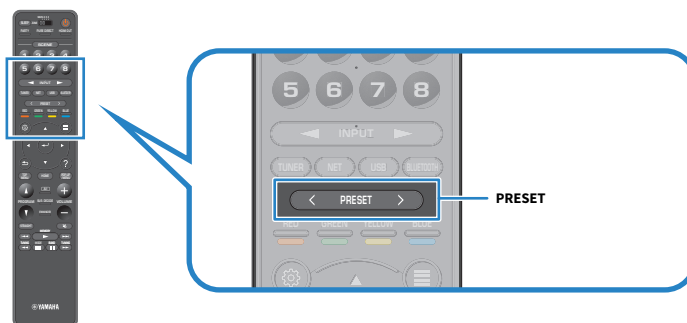

Playback of the selected content starts.

NOTE

- “No Presets” appears on the front display when no content is registered.
- The registered content (songs and Internet radio stations) can be displayed as a list and easily removed by using MusicCast Controller on your mobile device.

Related links

“Using MusicCast Controller” (p.111)

ENJOYING IN MULTIPLE ROOMS (ZONES)

Preparing zones

Playback in multiple rooms (multi zone function)

You can play back an input source in the room where the unit is installed and in another room.

You can use the unit according to your favorite, for example, while you are watching TV in the living room (Main zone), another person can listen to radio in the study room (Zone2).

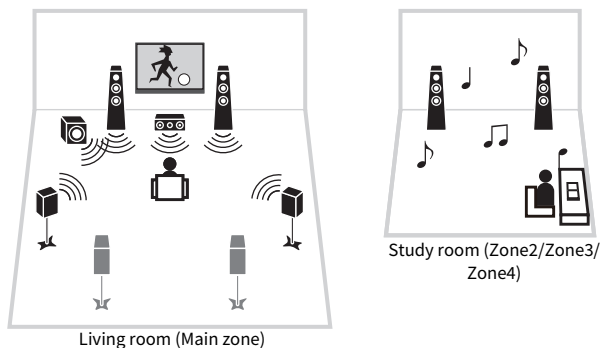

NOTE

- You can select different input sources in the room where the unit is installed (Main zone) and in another room (zone).
- Two methods are available; using the unit's internal amplifier or using an external amplifier.

Related links

- “Multi-zone configuration examples” (p.182)
- “Turning on/off the power of zones” (p.187)
- “Basic procedure in zone” (p.188)

Multi-zone configuration examples

You can enjoy videos/music using TVs and speakers placed in other rooms.

■ Enjoying music using speakers

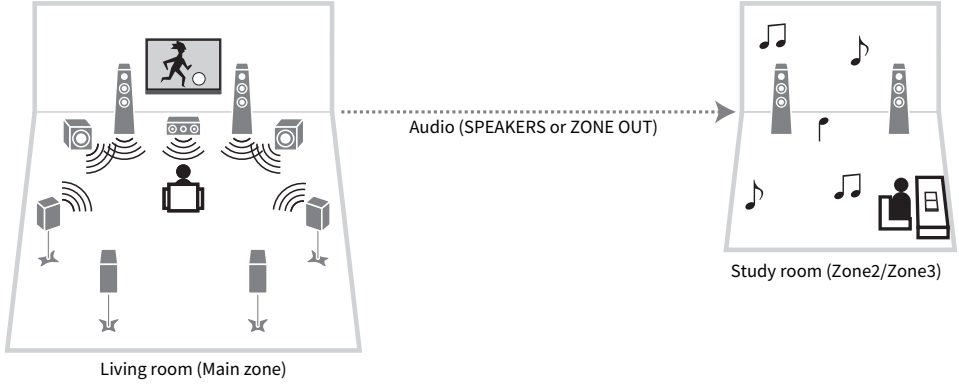

■ Enjoying videos/music using a TV and speakers

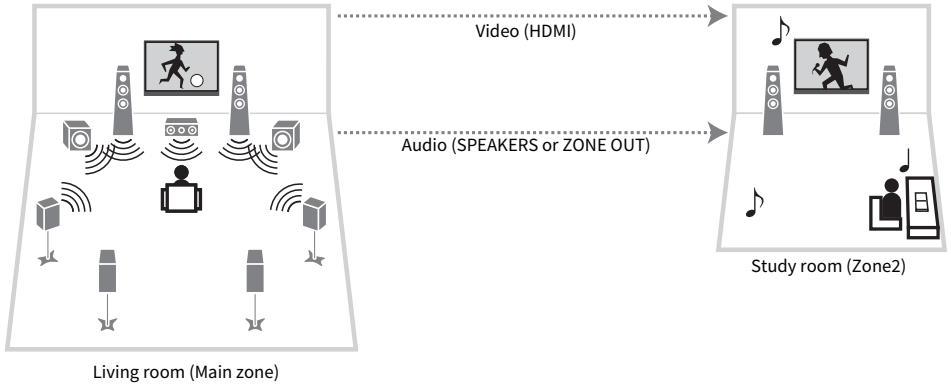

■ Enjoying videos/music using only a TV

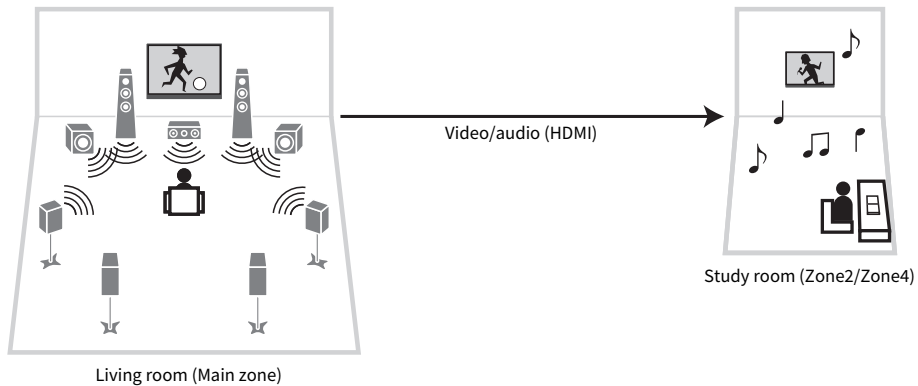

Related links

- “Connecting zone speakers using the unit’s internal amplifier” (p.184)
- “Connecting an HDMI device in zone” (p.186)

Connecting zone speakers

Connecting zone speakers using the unit's internal amplifier

Connect zone speakers to the unit with speaker cables. And according to the speaker's connection, change your speaker configuration setting.

NOTICE

- Unplug the unit's power cable from an AC wall outlet before connecting the speakers.

- 1 Connect zone speakers to the EXTRA SP1 or EXTRA SP2 terminals.**
- 2 Set "Power Amp Assign" in the "Setup" menu.**

NOTE

You can select a zone (Zone2 or Zone3) to be assigned to the EXTRA SP 1-2 jacks in "Power Amp Assign" in the "Setup" menu.

Related links

- "7.2 +1Zone" (p.61)
- "7.2.2 +1Zone" (p.63)
- "7.2 +2Zone" (p.65)
- "7.2.2 [ext.Front] +1Zone" (p.80)
- "7.2 [ext.Front] +2Zone" (p.82)
- "7.2 Bi-Amp +1Zone" (p.71)
- "Setting your speaker system" (p.226)

Connecting zone speakers using an external amplifier

Connect the external amplifier placed in zone to the unit with a stereo pin cable. You can adjust the volume for zone output with the unit. When using an external amplifier with volume control, set “Volume” in “Zone2” or “Zone3” in the “Setup” menu to “Fixed”.

NOTICE

- Unplug the unit’s power cable from the AC wall outlet before connecting an external amplifier.

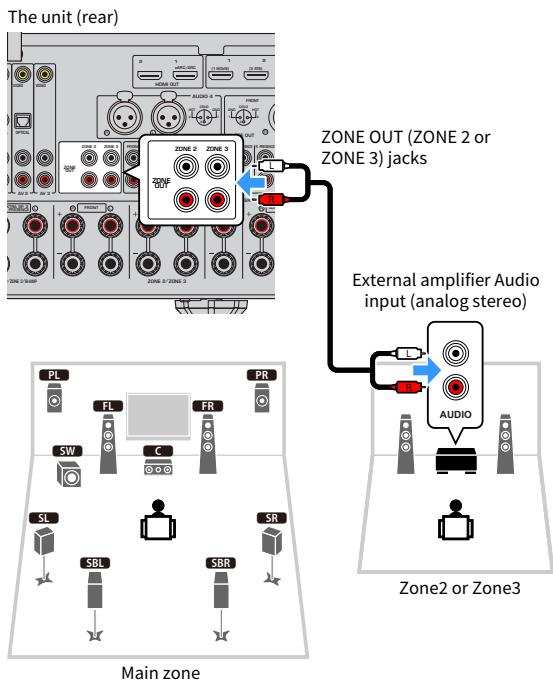

Related links

“Setting the use of volume adjustments for zone output” (p.300)

Connecting an HDMI device in zone

Connecting an HDMI device in zone to the unit

Connect an HDMI device (such as a TV) to play back videos/audio in zone. With an HDMI cable, HDMI OUT 3 (ZONE OUT) jack on the unit is connected to it.

- Videos/audio interruptions may happen in another zone when any of the following operations is performed.
 - Turning on/off a TV connected to the unit via HDMI or switching the TV input
 - Turning on/off a zone or selecting its input source
 - Changing the sound mode or audio settings

NOTE

- To assign the HDMI OUT 3 (ZONE OUT) jack to Zone2 or Zone4, set “HDMI ZONE OUT Assign” in the “Setup” menu.
- Set to enables/disable audio output to the HDMI OUT 3 (ZONE OUT) jack in “HDMI Audio Output” in the “Setup” menu.
- When you connect an AV amplifier, you can enjoy multichannel playback in Zone4.
- We recommend that you disable HDMI Control on the playback devices connected to the unit.
- The “Setup” menu and “Option” menu cannot be used with zones.
- The browse screen and playback screen are possible when “NET”, “USB” or “Bluetooth” is selected for the input source in Zone2.
- When the zone switch on the remote control is set to Zone2 or Zone4, you can turn on/off the HDMI OUT 3 (ZONE OUT) jack output by pressing HDMI OUT on the remote control.

Related links

- “Setting the zone assignment of the HDMI out jack” (p.279)
- “Setting the output of HDMI audio to the TV’s speakers” (p.278)

Operating zones

Turning on/off the power of zones

Switch the power of each zone between on and off.

1 Set the zone switch on the remote control to the zone that you want to operate.

2 Press .

Each time you press the key, you can turn on/off the zone.

When the zone is turned on, “ZONE” lights up on the front panel.

NOTE

- If all of the zones are turned off, the unit switches to the standby mode.
- You can switch the power of the zone in the “Front Display” menu.

Related links

- “Part names and functions of the front panel” (p.25)
- “Setting the power of each zone to on/standby” (p.342)

Basic procedure in zone

Basic procedure for playback in zone is as follows. The zone selected by the zone switch can be operated.

- 1 Turn on the zone.**
- 2 Turn on the external devices connected to the unit.**
- 3 Use the input selection keys to select an input source.**
- 4 Start playback on the external device or select a radio station.**
- 5 Press VOLUME to adjust the volume.**

NOTICE

- To avoid unexpected noise, never play back DTS-CDs in Zone2/Zone3/Zone4.

NOTE

- Only an HDMI input is available in Zone4.
- You cannot select “NET”, “USB” and “Bluetooth” exclusively for each zone. For example, if you select “SERVER” for Zone2 when “USB” is selected for the Main zone, the input source for the Main zone also switches to “SERVER”.
- The zone input automatically switches in conjunction with the input source selected in the Main zone when “Main Zone Sync” is selected as the Zone2 or Zone3 input.
- To adjust the zone volume, press VOLUME or MUTE when using the unit’s internal amplifier.
- Refer to the instruction manual for the external device.

Related links

- “Turning on/off the power of zones” (p.187)
- “Other procedure in zone” (p.189)

Other procedure in zone

Other procedure in every zone is as follows.

- Press SCENE key to select the input source and settings with just one touch.
- To set the sleep timer (120 min, 90 min, 60 min, 30 min, off), press SLEEP repeatedly. The zone output will be disabled after a specified period of time.
- To enable the Compressed Music Enhancer function, press ENHANCER.

NOTE

- You can select only the input source by pressing SCENE key in Zone4.
- In Zone2 or Zone3, to play back DSD audio and the audio signal whose sampling frequency is 352.8 kHz/384 kHz, select "Main Zone Sync" as the Zone2 or Zone3 input, or use the party mode.

Related links

- "Selecting the input source and favorite settings with one touch (SCENE)" (p.175)
- "Enjoying more powerful sound to the audio source (Compressed Music Enhancer)" (p.145)
- "Enjoying the same source in multiple rooms (party mode)" (p.190)

Enjoying the same source in multiple rooms (party mode)

The party mode allows you to play back in all zones the same music that is being played back in the Main zone. During the party mode, stereo playback is automatically selected for all zones.

Each time you press PARTY, the party mode is turned on or off.

NOTE

Zone4 audio output is available only when an HDMI input is selected in the Main zone.

Related links

[“Setting the use of switching to the party mode on zone” \(p.310\)](#)

CONFIGURATIONS

Configuring the unit

Using the menu

The unit is equipped with following menus.

“Option” menu:

You can configure playback settings according to the input source currently being played back. Operate this menu displayed on the TV with the remote control.

“Setup” menu:

You can configure the unit’s various functions. Operate this menu displayed on the TV with the remote control.

“Front Display” menu:

You can configure the unit’s system settings. Operate this menu displayed on the front display using the front panel.

NOTE

- The “Option” menu and the “Setup” menu displayed on the TV are the independent operation of the “Front Display” menu.
- You can operate the menu on the TV with the remote control, while you can operate the menu on the front display using the front panel.

Related links

- “Option menu items” (p.193)
- “Setup menu items” (p.216)
- “Front Display menu items” (p.340)

Configuring playback settings for different playback sources (Option menu)

Basic operation of the Option menu

Perform the following basic procedure to operate the “Option” menu. Operate this menu displayed on the TV with the remote control.

1 Press OPTION.

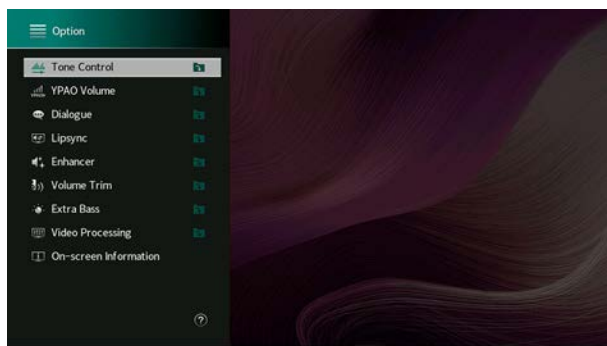
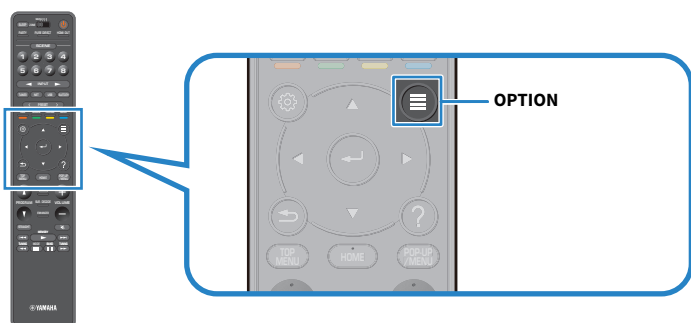

TV screen

2 Select an item.

3 Select a setting.

4 Press OPTION.

This completes the settings.

Related links

“Default settings of the Option menu” (p.442)

Option menu items

Use the following table to configure playback settings of the unit.

Item	Page	
Tone Control	p.194	
YPAO Volume	YPAO Volume	p.195
	Adaptive DRC	p.196
Dialogue	Dialogue Level	p.197
	DTS Dialogue Control	p.198
	Dialogue Lift	p.199
Lipsync	Lipsync	p.200
Enhancer	Enhancer	p.201
	Hi-Res Mode	p.202
Volume Trim	Input Trim	p.203
	Subwoofer Trim	p.204
Extra Bass	Extra Bass	p.205
Video Processing	Video Mode	p.206
	Video Adjustment	p.207
Video Out	Video Out	p.208
Shuffle / Repeat	Shuffle	p.209
	Repeat	p.210
Add to favorites	p.211	
Remove from favorites	p.212	
On-screen Information	p.213	

NOTE

- Available items vary depending on the selected input source.
- When the input icon is displayed on the upper right of the "Option" menu, the setting is applied to the currently selected input source. Otherwise, the setting is applied to all of the input sources.

Adjusting the tone of the audio output

Adjusts the level of high-frequency range (Treble) and low-frequency range (Bass) individually.

Option menu

“Tone Control”

Setting range

-6.0 dB to +6.0 dB

NOTE

- When both “Treble” and “Bass” are 0.0 dB, “Bypass” appears.
- If you set an extreme value, sounds may not match those from other channels.
- The audio output of the front speakers, center speaker and subwoofers can be adjusted.

Related links

“Basic operation of the Option menu” (p.192)

Configuring the volume automatically based on the YPAO measurement results

Adjusting the high- and low-frequency levels automatically according to the volume

Selects whether to adjust the high- and low-frequency levels to the volume automatically. If this function is set to “On”, you can enjoy natural sounds even at low volume. YPAO Volume works effectively after the YPAO measurement.

Option menu

“YPAO Volume” > “YPAO Volume”

Settings

Off	Disables YPAO Volume.
On	Enables YPAO Volume.

NOTE

- We recommend enabling both “YPAO Volume” and “Adaptive DRC” when you are listening at lower volumes or at night.
- “YPAO Volume” is automatically set to “On” after the YPAO measurement.

Related links

- “Flow of the speaker configurations” (p.115)
- “Adjusting the dynamic range automatically” (p.196)
- “Basic operation of the Option menu” (p.192)

Adjusting the dynamic range automatically

Selects whether to adjust the dynamic range (from maximum to minimum) to the volume automatically. If this function is set to “On”, it is useful for listening to playback at a low volume at night.

Option menu

“YPAO Volume” > “Adaptive DRC”

Settings

Off	Does not adjust the dynamic range automatically.
On	Automatically adjusts the dynamic range.

NOTE

We recommend enabling both “YPAO Volume” and “Adaptive DRC” when you are listening at lower volumes or at night.

Related links

- “Adjusting the high- and low-frequency levels automatically according to the volume” (p.195)
- “Basic operation of the Option menu” (p.192)

Adjusting the dialogue sounds

Adjusting the volume of dialogue sound

Adjusts the volume of dialogue sounds that are hardly heard. Higher value strengthens the dialogue sounds.

Option menu

“Dialogue” > “Dialogue Level”

Setting range

0 to 3

NOTE

This setting will be disabled if the following condition is met.

- DTS:X content is played back.

Related links

“Basic operation of the Option menu” (p.192)

Adjusting the volume of dialogue sound during DTS:X™ playback

Adjusts the volume of dialogue sounds that are hardly heard for DTS:X content. Higher value strengthens the dialogue sounds.

Option menu

“Dialogue” > “DTS Dialogue Control”

Setting range

0 to 6

NOTE

This setting is available only when DTS:X content which supports the DTS Dialogue Control feature is played back.

Related links

“Basic operation of the Option menu” (p.192)

Adjusting the perceived height of dialogue sound

Adjusts the perceived height of dialogue sounds when the position (height) of dialogue sound is artificial. Bigger setting value gets the higher position.

If the dialogue sounds as if it is coming from below the screen, you can raise its perceived height by increasing this setting.

Option menu

“Dialogue” > “Dialogue Lift”

Setting range

0 to 5

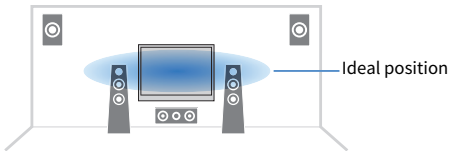

NOTE

This setting is available only when one of the following conditions is met.

- SURROUND:AI is enabled when front presence speakers are used.
- One of the sound programs is selected when front presence speakers are used except for “2ch Stereo”, “All-Channel Stereo”, “SURROUND DECODE” and “STRAIGHT” in the sound programs.
- Virtual Presence Speaker (VPS) is working. You may hear dialogue sounds from the surround speakers depending on the listening position.

Related links

“Basic operation of the Option menu” (p.192)

Adjusting the delay of the Lipsync function

Adjusts the delay between video and audio output (Lipsync) manually. This setting is available only when “Delay Enable” in the “Setup” menu is set to “Enable” for each input source.

Option menu

“Lipsync” > “Lipsync”

Setting range

0 ms to 500 ms

Related links

- “Enabling Lipsync adjustment” (p.243)
- “Basic operation of the Option menu” (p.192)

Setting Compressed Music Enhancer

Selects whether to use Compressed Music Enhancer. You can also use ENHANCER on the remote control to enable/disable Compressed Music Enhancer.

Option menu

“Enhancer” > “Enhancer”

Settings

Off	Disables Compressed Music Enhancer.
On	Enables Compressed Music Enhancer.

NOTE

This setting is applied separately to each input source.

Related links

- “Enjoying more powerful sound to the audio source (Compressed Music Enhancer)” (p.145)
- “Basic operation of the Option menu” (p.192)

Setting the high-resolution mode

Selects whether to use the high-resolution mode when “Enhancer” is set to “On”. If this function is set to “On”, you can enhance the quality of 2-channel uncompressed digital audio (such as PCM) and lossless compressed digital audio (such as FLAC) using Compressed Music Enhancer.

Option menu

“Enhancer” > “Hi-Res Mode”

Settings

Off	Disables the high-resolution mode.
On	Enables the high-resolution mode. The high-resolution mode may not work depending on the audio signal processing condition.

Related links

“Basic operation of the Option menu” (p.192)

Correcting volume differences during playback

Correcting volume differences between input sources

Corrects volume differences between input sources. If you are bothered by volume differences when switching between input sources, use this function to correct it.

Option menu

“Volume Trim” > “Input Trim”

Setting range

-6.0 dB to +6.0 dB

NOTE

This setting is applied separately to each input source.

Related links

“Basic operation of the Option menu” (p.192)

Adjusting the subwoofer volume

Fine-adjusts the subwoofer volume.

Option menu

“Volume Trim” > “Subwoofer Trim”

Setting range

-6.0 dB to +6.0 dB

Related links

“Basic operation of the Option menu” (p.192)

Setting the use of Extra Bass

Uses Extra Bass to enhance bass sound. If this function is set to “On”, you can enjoy sufficient bass sounds, regardless of the size of the front speakers and the presence or absence of the subwoofer.

Option menu

“Extra Bass” > “Extra Bass”

Settings

Off	Disables Extra Bass.
On	Enables Extra Bass.

Related links

“Basic operation of the Option menu” (p.192)

Enabling the video signal processing

Selects whether to use the video signal processing (resolution, aspect ratio and adjustment) settings configured in “Video Mode” in the “Setup” menu.

Option menu

“Video Processing” > “Video Mode”

Settings

Direct	Disables the video signal processing.
Processing	Enables the video signal processing.

Related links

- “Setting a resolution to output HDMI video signals” (p.272)
- “Setting an aspect ratio to output HDMI video signals” (p.273)
- “Setting the video adjustments to output HDMI video signals” (p.274)
- “Basic operation of the Option menu” (p.192)

Selecting the video adjustment setting

Selects a video adjustment setting from presets you have configured in “Adjustment” in the “Setup” menu.

Option menu

“Video Processing” > “Video Adjustment”

Setting range

1 to 6

NOTE

This setting is applied separately to each input source.

Related links

- “Setting the video adjustments to output HDMI video signals” (p.274)
- “Basic operation of the Option menu” (p.192)

Selecting a video source to be displayed with the selected audio source

Selects a video source to be displayed with the selected audio source. You can watch the video from a different source while listening to the radio and so on.

Option menu

“Video Out” > “Video Out”

Settings

Off	Does not output video.
HDMI 1-7, AV 1-3	Outputs video input through the corresponding video input jack.

NOTE

In “Video Out” menu, you can select a video source to be displayed with the input only audio except HDMI.

Related links

“Basic operation of the Option menu” (p.192)

Configuring the shuffle/repeat setting

Configuring the shuffle setting

Configures the shuffle setting for playback.

Option menu

“Shuffle / Repeat” > “Shuffle”

Settings

Off	Turns off the shuffle function.
On	Plays back songs in the current album (folder) in random order.

NOTE

This setting is available only when “USB” or “SERVER” is selected as the input source.

Related links

“Basic operation of the Option menu” (p.192)

Configuring the repeat setting

Configures the repeat setting for playback.

Option menu

“Shuffle / Repeat” > “Repeat”

Settings

Off	Turns off the repeat function.
One	Plays back the current song repeatedly.
All	Plays back all songs in the current album (folder) repeatedly.

NOTE

This setting is available only when “USB” or “SERVER” is selected as the input source.

Related links

“Basic operation of the Option menu” (p.192)

Adding a “NET RADIO” radio station to the “Favorites” folder

When you select “NET RADIO” as the input source, you can register the currently playing radio station to the “Favorites” folder.

On the playback screen, the current station is added to the “Favorites” folder.

On the browse screen, the station selected in the list is added to the “Favorites” folder.

Option menu

“Add to favorites”

NOTE

- Radio stations registered to favorites are displayed with “★”.
- You can register Internet radio stations as shortcuts.

Related links

- “Removing a radio station from the “Favorites” folder” (p.212)
- “Registering a favorite content as shortcut” (p.179)

Removing a radio station from the “Favorites” folder

Removes a radio station from the “Favorites” folder. On the browse screen, select the station to be removed in advance.

Option menu

“Remove from favorites”

Checking the current status information

Displays the current status information on the TV. Use the left/right cursor keys to display other information on each hierarchy of the “Setup” menu.

Option menu

“On-screen Information”

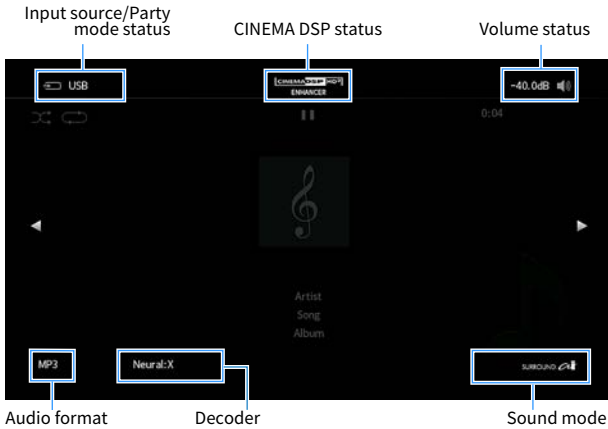

NOTE

- The figure shows the location where each status information is displayed on the TV and is different from an actual information display.
- When SURROUND:AI is enabled, you can display the SURROUND:AI status information.
- You can use the PROGRAM keys on the remote control to display the current status information on the TV.
- To close the information display, press RETURN on the remote control.

Related links

- “Checking the network information of the unit” (p.284)
- “Checking the zone information” (p.299)
- “Checking the system information on the unit” (p.311)
- “Playing back with surround effects optimized for the scene (SURROUND:AI)” (p.132)
- “Setting the function for the PROGRAM keys on the remote control” (p.321)

Configuring various functions (Setup menu)

Basic operation of the Setup menu

Perform the following basic procedure to operate the “Setup” menu. Operate this menu displayed on the TV with the remote control.

1 Press SETUP.

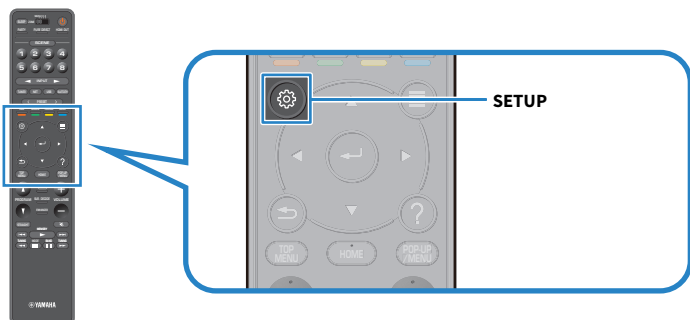

2 Select a menu.

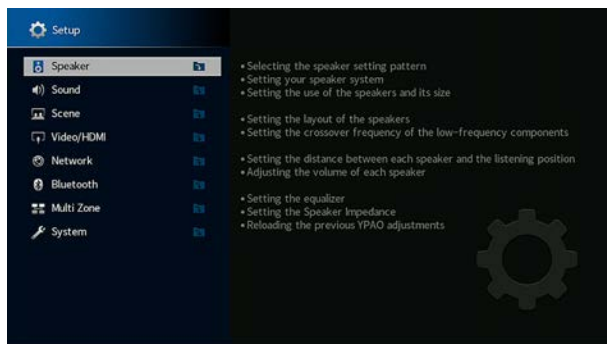

3 Select an item.

4 Select a setting.

5 Press SETUP.

This completes the settings.

NOTE

- If new firmware is available, the message screen appears.
- If new firmware is available, the envelope icon (✉) appears in the “Setup” menu.

Related links

- “Updating the unit’s firmware via the network” (p.355)
- “Default settings of the Setup menu” (p.443)

Setup menu items

Speaker Settings

Item	Page	
Setting Pattern	p.224	
Setting Data Copy	p.225	
Power Amp Assign	p.226	
Configuration	Front	p.227
	Center	p.227
	Surround	p.227
	Surround Back	p.227
	Front Presence	p.227
	Rear Presence	p.227
	Subwoofer	p.232
Distance	p.235	
Level	p.236	
Parametric EQ	p.237	
Speaker Impedance	p.239	
Test Tone	p.240	
YPAO Result	Setup Reload	p.241

Sound Settings

Item	Page
Information	p.242
	Delay Enable p.243
Lipsync	Auto/Manual Select p.244
	Adjustment p.245
DSP Parameter	(sound program) p.246
Surround Decoder	AURO-3D p.248
	Level p.251
	Front / Rear Balance p.252
All-Channel Stereo	Left / Right Balance p.253
	Height Balance p.254
	Monaural Mix p.255
Dynamic Range	p.256
	Max Volume p.257
Volume	Initial Volume p.258
Pure Direct Mode	p.259
Adaptive DSP Level	p.260
	VPS p.261
Virtual Speaker	VSBS p.262
	Dolby Speaker Virtualization p.263
Ultra Low Jitter PLL Mode	p.264
DAC Digital Filter	p.265
Balance Input Attenuator	p.266
DTS Mode	p.267

Scene Settings

Item	Page
Scene Setting	p.268
Scene Rename	p.269

Video/HDMI Settings

Item	Page
Information	p.270
Video Mode	p.271
Video Mode	Resolution
	p.272
	Aspect
	p.273
	Adjustment
	p.274
HDMI Control	HDMI Control
	p.275
	ARC
	p.276
	Standby Sync
	p.277
HDMI Audio Output	p.278
HDMI ZONE OUT Assign	p.279
HDCP Version	p.280
HDMI Standby Through	p.281
HDMI Video Format	p.282

Network Settings

Item	Page
Information	p.284
Network Connection	p.285
IP Address	p.287
Network Standby	p.288
DMC Control	p.289
AirPlay Volume Interlock	p.290
Network Name	p.291
MusicCast Link Power Interlock	p.292

Bluetooth Settings

Item	Page
Bluetooth	p.293
Disconnect	p.294
Audio Receive	Bluetooth Standby
	p.295
	Bluetooth Volume Interlock
	p.296
Audio Send	Transmitter
	p.297
	Device Search
	p.298

Multi Zone Settings

Item	Page
Information	p.299
Volume	p.300
Max Volume	p.301
Initial Volume	p.302
Audio Delay	p.303
(zone)	p.304
Monaural	p.304
Enhancer	p.305
Tone Control	p.306
Extra Bass	p.307
Left / Right Balance	p.308
Zone Rename	p.309
Party Mode Set	p.310

System Settings

Item	Page	
Information	p.311	
Language	p.312	
Audio In	p.313	
TV Audio Input	p.314	
Input Skip	p.315	
Input Rename	p.316	
Auto Play	p.318	
DSP Skip	p.319	
Tuner	p.320	
Remote Key	PROGRAM Key	p.321
	Color Key	p.322
	Dimmer	p.323
	Volume	p.324
Display Settings	Short Message	p.325
	Position	p.326
	Wallpaper	p.327
Touch Sound	p.328	
Trigger Output	Trigger Mode	p.329
	Target Zone	p.332
ECO	Auto Power Standby	p.333
	ECO Mode	p.334
Memory Guard	p.335	
Initialization	p.336	
Backup/Restore	p.337	
Firmware Update	p.338	

Configuring the speaker settings

Selecting the speaker setting pattern

Registers speaker setting patterns.

The following speaker settings will be memorized in the selected pattern.

- Power Amp Assign
- Configuration
- Distance
- Level
- Parametric EQ
- Measurement results (YPAO)

Setup menu

“Speaker” > “Setting Pattern”

Settings

Pattern1, Pattern2

NOTE

- The setting pattern currently selected is shown at the center of the diagram on the right side of the screen.
- This function is useful when you want to save certain settings according to the varying conditions of your listening environment. For example, you can switch the settings when curtains are open or closed.

Related links

“Basic operation of the Setup menu” (p.214)

Copying the speaker setting pattern

Copies the “Setting Pattern” parameters to another pattern.

Setup menu

“Speaker” > “Setting Data Copy”

- 1 Select the speaker setting pattern in Source.**
- 2 Select the pattern in Destination.**
- 3 Select “Copy”.**

The pattern is copied.

NOTE

“Copy” is not selectable if the same pattern is selected in Source and Destination.

Related links

“Basic operation of the Setup menu” (p.214)

Setting your speaker system

Selects the setting according to the speakers that are connected.

Setup menu

“Speaker” > “Power Amp Assign”

Settings

Basic	A normal speaker system.
7.2 +1Zone	Zone speakers in addition to the 7.2 system in the Main zone.
7.2.2 +1Zone	Zone speakers in addition to the 7.2.2 system in the Main zone.
7.2 +2Zone	Two zones speakers in addition to the 7.2 system in the Main zone.
7.2.4 [ext.RP]	The 7.2.4 system (using rear presence channel expansion via an external power amplifier).
7.2.4 [ext.Front]	The 7.2.4 system (using front channel expansion via an external power amplifier).
7.2.2 [ext.Front] +1Zone	Zone speakers in addition to the 7.2.2 system (using front channel expansion via an external power amplifier) in the Main zone.
7.2 [ext.Front] +2Zone	Two zones speakers in addition to the 7.2 system (using front channel expansion via an external power amplifier) in the Main zone.
7.2 Bi-Amp	The 7.2 system (using bi-amp connections for the front speakers).
5.2.2 Bi-Amp	The 5.2.2 system (using bi-amp connections for the front speakers).
7.2 Bi-Amp +1Zone	Zone speakers in addition to the 7.2 system (using bi-amp connections for the front speakers).

Related links

- “7.2 Bi-Amp” (p.67)
- “5.2.2 Bi-Amp” (p.69)
- “7.2.4 [ext.RP]” (p.76)
- “7.2.4 [ext.Front]” (p.78)
- “Connecting zone speakers using the unit’s internal amplifier” (p.184)
- “Basic operation of the Setup menu” (p.214)

Setting the use of each speaker and its size

Selects the setting according to the use and size of your speakers.

Setup menu

“Speaker” > “Configuration” > (speaker)

Settings

Small	Small speakers. As a general guideline, the woofer diameter is smaller than 16 cm (6.1/4”). The subwoofer will produce low-frequency components (configurable in “Crossover”).
Large	Large speakers. As a general guideline, the woofer diameter is larger than 16 cm (6.1/4”). The speaker will produce all of the frequency components.
None	No speaker is connected. Channel audio of the speaker set to “None” will be produced from the other speakers.

NOTE

- The speaker size of the front speakers is automatically set to “Large” when both “Subwoofer 1” and “Subwoofer 2” in the “Setup” menu are set to “None”.
- Be sure to connect the front left and right speakers.

Related links

- “Setting the crossover frequency of the low-frequency components” (p.231)
- “Setting the use of a subwoofer” (p.232)
- “Basic operation of the Setup menu” (p.214)

■ When no speaker in a speaker type is connected

“Configuration” of the speaker type, in which no speaker is connected, in the “Speaker” is set to “None”. The other speakers will produce its channel audio.

- Center channel audio
The front speakers will produce center channel audio.
- Surround channel audio
The front speakers will produce surround channel audio. Virtual CINEMA DSP works in this case.
- Surround back channel audio
The surround speakers and subwoofer (or front speakers) will produce surround back channel audio.
- Presence channel audio
The surround speakers and subwoofer (or front speakers) will produce presence channel audio.

Setting the layout of the surround speakers

Selects a surround speaker layout when surround speakers are used. This setting is not available when “Surround” is set to “None”.

Setup menu

“Speaker” > “Configuration” > “Surround” > “Layout”

Settings

Rear	The surround speakers are placed on the rear side of the room.
Front	The surround speakers are placed on the front side of the room. Virtual CINEMA FRONT works in this case.

Related links

- “Setting the use of each speaker and its size” (p.227)
- “Enjoying surround sound with 5 speakers placed in front (Virtual CINEMA FRONT)” (p.138)
- “Basic operation of the Setup menu” (p.214)

Setting the layout of the front presence speakers

Selects a presence layout when front presence speakers are used. This setting facilitates the optimization of the sound field effect.

Setup menu

“Speaker” > “Configuration” > “Front Presence” > “Layout”

Settings

Front Height	The front presence speakers are installed on the front wall.
Overhead	The front presence speakers are installed to the ceiling.
Dolby Enabled SP	The Dolby Enabled speakers are used as the front presence speakers.

Related links

- “Setting the use of each speaker and its size” (p.227)
- “Presence speaker layout” (p.420)
- “Basic operation of the Setup menu” (p.214)

Setting the layout of the rear presence speakers

Selects a presence layout when rear presence speakers are used. This setting facilitates the optimization of the sound field effect.

Setup menu

“Speaker” > “Configuration” > “Rear Presence” > “Layout”

Settings

Rear Height	The rear presence speakers are installed on the rear wall.
Overhead	The rear presence speakers are installed to the ceiling.
Dolby Enabled SP	The Dolby Enabled speakers are used as the rear presence speakers.

Related links

- “Setting the use of each speaker and its size” (p.227)
- “Presence speaker layout” (p.420)
- “Basic operation of the Setup menu” (p.214)

Setting the crossover frequency of the low-frequency components

Sets the lower limit of the low-frequency components that can be output from a speaker whose size is set to “Small”.

A frequency sound lower than the specified value will be produced from the subwoofer or front speakers.

Setup menu

“Speaker” > “Configuration” > (speaker) > “Crossover”

Settings

40 Hz, 60 Hz, 80 Hz, 90 Hz, 100 Hz, 110 Hz, 120 Hz, 160 Hz, 200 Hz

NOTE

When the volume and crossover frequency are adjustable on your subwoofer, set your subwoofer as follows.

- The volume is set to half.
- The crossover frequency is set to maximum.

Related links

- “Setting the use of each speaker and its size” (p.227)
- “Basic operation of the Setup menu” (p.214)

Setting the use of a subwoofer

Selects the setting according to the use of your subwoofer.

Setup menu

“Speaker” > “Configuration” > “Subwoofer” > “Subwoofer 1”/“Subwoofer 2”

Settings

Use	A subwoofer is connected. The subwoofer will produce LFE (low-frequency effect) channel audio and low-frequency components from other channels.
None	No subwoofer is connected. The front speakers will produce low-frequency components.

Related links

“Basic operation of the Setup menu” (p.214)

Setting the phase of the subwoofer

Sets the phase of the subwoofer. When the bass sound is lacking, switch the subwoofer phase.

Setup menu

“Speaker” > “Configuration” > “Subwoofer” > “Subwoofer 1”/“Subwoofer 2” > “Phase”

Settings

Normal	Does not reverse the subwoofer phase.
Reverse	Reverses the subwoofer phase.

Related links

- “Setting the use of a subwoofer” (p.232)
- “Basic operation of the Setup menu” (p.214)

Setting the layout of the subwoofers

Selects the subwoofers layout when 2 subwoofers are used. This setting is available when both “Subwoofer 1” and “Subwoofer 2” in the “Setup” menu are set to “Use”.

Setup menu

“Speaker” > “Configuration” > “Subwoofer” > “Layout”

Settings

Left + Right	Two subwoofers are placed on the left and right sides of the room.
Front + Rear	Two subwoofers are placed on the front and rear sides of the room.
Monaural x2	Two subwoofers are placed freely in the room.

Related links

- “Setting the use of a subwoofer” (p.232)
- “Basic operation of the Setup menu” (p.214)

Setting the distance between each speaker and the listening position

Sets the distance so that sounds from the speakers reach the listening position at the same time.

Setup menu

“Speaker” > “Distance” > (speaker)

Setting range

0.30 m to 24.00 m (1.0 ft to 80.0 ft)

NOTE

Select the unit of distance from “Meter” or “Feet” in “Unit”.

Related links

- “Setting the use of each speaker and its size” (p.227)
- “Basic operation of the Setup menu” (p.214)

Adjusting the volume of each speaker

Adjusts the volume of each speaker to suit your listening position.

Setup menu

“Speaker” > “Level” > (speaker)

Setting range

-10.0 dB to +10.0 dB

NOTE

Test tone output helps you to adjust the speaker balance while confirming its effect.

Related links

- “Setting the use of each speaker and its size” (p.227)
- “Outputting test tones” (p.240)
- “Basic operation of the Setup menu” (p.214)

Setting the equalizer

Selects the type of equalizer to adjust the tone.

Setup menu

“Speaker” > “Parametric EQ”

Settings

Manual	Adjusts the equalizer manually.
YPAO:Flat	Adjusts each speaker to achieve the same characteristics.
YPAO:Front	Adjusts each speaker to achieve the same characteristics as the front speakers.
YPAO:Natural	Adjusts each speaker to achieve the same characteristics with lowered high frequency range.
YPAO:Low Frequency	Detects the frequency in low frequency range to be compensated. This function does not compensate the Q factor and gain besides frequency, so that in “Manual”, you may copy the parametric equalizer values of “YPAO:Low Frequency”, and adjust the Q factor or gain manually.
Through	Does not use the equalizer.

NOTE

Select “YPAO:Flat”, “YPAO:Front”, “YPAO:Natural” or “YPAO:Low Frequency” and press ENTER again to view the results of adjusting the tone. These functions are available only when the YPAO measurement results have already been saved.

Related links

- “Flow of the speaker configurations” (p.115)
- “Basic operation of the Setup menu” (p.214)

■ Adjusting the equalizer manually

You can adjust the equalizer manually. First, “Parametric EQ” in “Speaker” is set to “Manual”.

Setting range

Center frequency	15.6 Hz to 16.0 kHz (15.6 Hz to 250.0 Hz for subwoofer)
Q factor	0.500 to 10.080
Gain	-20.0 dB to +6.0 dB

- 1 Select “Manual”.**
- 2 Press ENTER again to enter the edit screen.**
- 3 Select a speaker.**

4 Select a band.



5 Adjust the center frequency, Q factor (bandwidth) or gain (level).

6 Press SETUP.

This completes the settings.

NOTE

- To restore the default settings for all speakers, select “PEQ Data Clear” and then “OK”.
- To copy the parametric equalizer values of “YPAO:Flat”, “YPAO:Front”, “YPAO:Natural” or “YPAO:Low Frequency” to the “Manual” fields, select “PEQ Data Copy”. You can use this function for fine adjustment of the YPAO measurement results.

Related links

“Setting the use of each speaker and its size” (p.227)

Setting the speaker impedance

Sets the unit's speaker impedance settings depending on the impedance of the speakers connected.

Setup menu

“Speaker” > “Speaker Impedance”

Settings

6Ω MIN	For 6-ohm or higher speakers. You can also connect 4-ohm speakers for the front speakers.
8Ω MIN	For 8-ohm or higher speakers.

Related links

“Basic operation of the Setup menu” (p.214)

Outputting test tones

Outputs the test tone when you adjust the speaker balance or equalizer while confirming its effect.

Setup menu

“Speaker” > “Test Tone”

Settings

Off	Does not output test tones.
On	Outputs test tones.

Related links

“Basic operation of the Setup menu” (p.214)

Reloading the previous YPAO adjustments

Reloads the previous YPAO adjustments.

You can use this function to retry the YPAO measurement when the speaker settings you have configured manually are not suitable.

Setup menu

“Speaker” > “YPAO Result” > “Setup Reload”

Related links

- “Flow of the speaker configurations” (p.115)
- “Basic operation of the Setup menu” (p.214)

Configuring the sound settings

Checking the audio signal information

Displays information about the audio signal and the status of sound settings.

Setup menu

“Sound” > “Information”

Input	Format	Audio format of the input signal
	Channel	The number of source channels in the input signal (front/surround/LFE) For example, “5.1 (3/2/0.1)” means 5.1ch in total (3 front channels, 2 surround channels, and LFE).
	Sampling	The number of samples per second of the input digital signal (sampling frequency)
	Dialogue	The dialogue normalization level of the input bitstream signal
Output	Channel	The number and name of output channels (speaker terminals and PRE OUT jacks) from which signals are output For example, “5.1.2” means standard 5.1-channel plus 2 channels for overhead speaker channels.

NOTE

- Depending on the type of the current audio signal, some of the information may not be displayed.
- Even when the unit is set to output bitstream signals directly, the signal may be converted depending on the specifications and settings of the playback device.
- You can also check which channels are currently outputting sound by “Output Channel” information on the front display.



Indicators

Related links

- “Selecting the input information displayed on the front display” (p.29)
- “Basic operation of the Setup menu” (p.214)

Enabling Lipsync adjustment

Selects whether to use the delay adjustment between video and audio output (Lipsync).

Setup menu

“Sound” > “Lipsync” > “Delay Enable”

Settings

Disable	Disables the “Lipsync” adjustment.
Enable	Enables the “Lipsync” adjustment.

NOTE

This setting is applied separately to each input source.

Related links

- “Setting the adjustment method of the Lipsync function” (p.244)
- “Basic operation of the Setup menu” (p.214)

Setting the adjustment method of the Lipsync function

Selects the method for adjusting the delay between video and audio output (Lipsync).

Setup menu

“Sound” > “Lipsync” > “Auto/Manual Select”

Settings

Manual	Adjusts the delay between video and audio output manually. The setting in “Adjustment” is applied to the audio output timing.
Auto	Adjusts the delay between video and audio output automatically. This setting is available only when a TV that supports an automatic lipsync function is connected to the unit via HDMI. You can fine-adjust the audio output timing in “Adjustment”.

Related links

- “Adjusting the delay of the Lipsync function” (p.245)
- “Basic operation of the Setup menu” (p.214)

Adjusting the delay of the Lipsync function

Adjusts the delay between video and audio output (Lipsync) manually.

Setup menu

“Sound” > “Lipsync” > “Adjustment”

Setting range

0 ms to 500 ms

NOTE

You can fine-adjust the audio output timing when “Select” in the “Setup” menu is set to “Auto”.

Related links

- “Setting the adjustment method of the Lipsync function” (p.244)
- “Basic operation of the Setup menu” (p.214)

Adjusting the sound field effect level

Adjusts the effect level of the sound program to enhance or reduce the sound field effect.

Select the sound program and press ENTER for adjusting.

Setup menu

“Sound” > “DSP Parameter” > (sound program)

Setting range

Item	Function	Settings
DSP Level	Adjusts the effect level of the sound program (to enhance or reduce the sound field effect).	-6 dB+3 dB
Initial Delay	Adjusts the delay between the direct sound and presence sound field generation. Higher value delays the sound field generation, and lower value quickens it. The presence sound field is created in the front side.	1 ms-99 ms
Room Size	Adjusts the broadening effect of the presence sound field. Higher value enhances the broadening effect, and lower value reduces it. The presence sound field is created in the front side.	0.1-2.0
Liveness	Adjusts the loss of the presence sound field. Higher value strengthens the reflectivity, and lower value weakens it. The presence sound field is created in the front side.	0-10
Reverb Time	Adjusts the decay time of the reverberant sound. Higher value enriches the reverberant sound, and lower value has clear sound.	1.0 s-5.0 s
Reverb Delay	Adjusts the delay between the direct sound and reverberant sound generation. Higher value delays the reverberant sound generation, and lower value quickens it.	0 ms-250 ms
Reverb Level	Adjusts the volume of the reverberant sound. Higher value strengthens the reverberant sound, and lower value weakens it.	0%-100%
Surround Initial Delay	Adjusts the delay between the direct sound and surround sound field generation. Higher value delays the sound field generation, and lower value quickens it. The surround sound field is created in the rear side of right and left.	1 ms-49 ms
Surround Room Size	Adjusts the broadening effect of the surround sound field. Higher value enhances the broadening effect, and lower value reduces it. The surround sound field is created in the rear side of right and left.	0.1-2.0
Surround Liveness	Adjusts the loss of the surround sound field. Higher value strengthens the reflectivity, and lower value weakens it. The surround sound field is created in the rear side of right and left.	0-10
Surround Back Initial Delay	Adjusts the delay between the direct sound and surround back sound field generation. Higher value delays the sound field generation, and lower value quickens it. The surround back sound field is created in the rear side.	1 ms-49 ms

CONFIGURATIONS > Configuring various functions (Setup menu)

Item	Function	Settings
Surround Back Room Size	Adjusts the broadening effect of the surround back sound field. Higher value enhances the broadening effect, and lower value reduces it.	0.1-2.0
	The surround back sound field is created in the rear side.	
Surround Back Liveness	Adjusts the loss of the surround back sound field. Higher value strengthens the reflectivity, and lower value weakens it.	0-10
	The surround back sound field is created in the rear side.	

NOTE

Available setting items and set values vary depending on the sound program.

Related links

- “Enjoying sound field effects optimized for the type of content” (p.134)
- “Basic operation of the Setup menu” (p.214)

Setting the operation mode of the AURO-3D decoder

Sets the operation mode of the AURO-3D decoder. It is used when “AURO-3D” is selected in the surround decoder settings.

Setup menu

“Sound” > “Surround Decoder” > “AURO-3D” > “AURO-3D Listening Mode”

Settings

AURO-3D	The optimal mode for playback of discs recorded in AURO-3D. On these discs, all channels, including the height channel, are recorded independently, giving you a richly realistic 3D surround sound experience. Other mono, stereo, and surround content can be upmixed to natural 3D surround with Auro-Matic.
Surround	The optimal mode for playback of discs recorded in AURO-3D without using presence speakers. Other mono, stereo, and surround content can be upmixed to natural 3D surround with Auro-Matic.
Native	Playback of the input AURO-3D signal with the channels the same as they are recorded. Channel expansion by upmixing is not performed.

NOTE

When front presence speakers are not installed, playback will be performed by Auro Surround even if “AURO-3D” is selected.

Related links

- “Enjoying AURO-3D®” (p.144)
- “Basic operation of the Setup menu” (p.214)

Selecting the upmix preset of the AURO-3D decoder

Selects the one of presets for the Auro-Matic that best suits the content you want to play. The AURO-3D decoder has the upmix function (Auro-Matic) that is tuned for effective AURO-3D playback according to your content. It is used when “AURO-3D” is selected in the surround decoder settings.

Setup menu

“Sound” > “Surround Decoder” > “AURO-3D” > “Auro-Matic Preset”

Settings

Small	This preset is ideal for pop music and chamber music.
Medium	This preset is ideal for jazz music, general movies, and TV programs.
Large	This preset is ideal for content recorded in a large space, such as an orchestra.
Movie	This preset is ideal for movie content such as action movies with scenes of loud explosions.
Speech	This preset is ideal for news broadcasts, talk shows, and other content that is mostly dialogue and has no spatial information.

Related links

- “Enjoying AURO-3D®” (p.144)
- “Basic operation of the Setup menu” (p.214)

Adjusting the level of upmixing of the AURO-3D decoder

Adjusts the level of the Auro-Matic upmix for the original input signal. It is used when “AURO-3D” is selected in the surround decoder settings.

Setup menu

“Sound” > “Surround Decoder” > “AURO-3D” > “Auro-Matic Strength”

Setting range

0 to 15

NOTE

The upmix is not performed when “Auro-Matic Strength” is set to “0”.

Related links

- “Enjoying AURO-3D®” (p.144)
- “Basic operation of the Setup menu” (p.214)

Adjusting the entire volume

Adjusts the entire volume. This setting is effective when “All-Channel Stereo” is selected in the sound programs.

Setup menu

“Sound” > “All-Channel Stereo” > “Level”

Setting range

-5 to +5

Related links

“Basic operation of the Setup menu” (p.214)

Adjusting the front and rear volume balance

Adjusts the front and rear volume balance. Higher value enhances the front side, and lower value enhances the rear side. This setting is effective when “All-Channel Stereo” is selected in the sound programs.

Setup menu

“Sound” > “All-Channel Stereo” > “Front / Rear Balance”

Setting range

-5 to +5

Related links

“Basic operation of the Setup menu” (p.214)

Adjusting the left and right volume balance

Adjusts the left and right volume balance. Higher value enhances the right side, and lower value enhances the left side. This setting is effective when “All-Channel Stereo” is selected in the sound programs.

Setup menu

“Sound” > “All-Channel Stereo” > “Left / Right Balance”

Setting range

-5 to +5

Related links

“Basic operation of the Setup menu” (p.214)

Adjusting the height volume balance

Adjusts the height volume balance using the front presence speakers. Higher value enhances the upside, and lower value enhances the downside. This setting is effective “All-Channel Stereo” is selected in the sound programs.

Setup menu

“Sound” > “All-Channel Stereo” > “Height Balance”

Setting range

0 to 10

NOTE

The front presence speakers do not produce sounds when “Height Balance” is set to “0”.

Related links

“Basic operation of the Setup menu” (p.214)

Setting the use of Monaural Mix

Outputs mixed monaural sound. This setting is effective when “All-Channel Stereo” is selected in the sound programs.

Setup menu

“Sound” > “All-Channel Stereo” > “Monaural Mix”

Settings

Off	Disables monaural sound output.
On	Enables monaural sound output.

Related links

“Basic operation of the Setup menu” (p.214)

Setting the dynamic range adjustment method

Selects the dynamic range (from maximum to minimum) adjustment method for Dolby Digital and DTS signals playback.

Setup menu

“Sound” > “Dynamic Range”

Settings

Maximum	Produces audio without adjusting the dynamic range.
Standard	Optimizes the dynamic range for regular home use.
Minimum/Auto	Sets the dynamic range for clear sound even at night or at low volumes. When playing back Dolby TrueHD signals, the dynamic range is automatically adjusted based on the input signal information.

Related links

“Basic operation of the Setup menu” (p.214)

Setting the limit value of the volume

Sets the limit value of the volume adjusted by using such as VOLUME keys on the remote control.

Setup menu

“Sound” > “Volume” > “Max Volume”

Setting range

-60.0 dB to +15.0 dB, +16.5 dB [20.5 to 95.5, 97.0]

Related links

“Basic operation of the Setup menu” (p.214)

Setting the initial volume for when the unit is turned on

Sets the initial volume when the unit is turned on.

Setup menu

“Sound” > “Volume” > “Initial Volume”

Settings

Off		Sets the volume level when it last entered standby mode.
	Mute	Mutes the audio output.
On	-80.0 dB to +16.5 dB [0.5 to 97.0]	Sets the specified volume level. This setting works only when the volume level is set lower than “Max Volume”.

Related links

- “Setting the limit value of the volume” (p.257)
- “Basic operation of the Setup menu” (p.214)

Setting the video output during the Pure Direct

Selects whether to output video signals when the Pure Direct is effective.

Setup menu

“Sound” > “Pure Direct Mode”

Settings

	Outputs video signals.
Auto	Any videos from the selected input source or the on-screen display are automatically displayed. When no video signals are input, the wall paper is displayed.
Video Off	Does not output video signals. The wall paper is not also displayed.

Related links

- “Enjoying higher quality playback (Pure Direct)” (p.142)
- “Basic operation of the Setup menu” (p.214)

Adjusting the sound field effect level automatically

Selects whether to automatically adjust the effect level of the sound program.

Setup menu

“Sound” > “Adaptive DSP Level”

Settings

Off	Does not adjust the effect level automatically.
On	Adjusts the effect level automatically depending on the YPAO measurement results and volume adjustments.

Related links

“Basic operation of the Setup menu” (p.214)

Setting Virtual Presence Speaker (VPS)

Selects whether to create Virtual Presence Speaker (VPS). When VPS is enabled, using the front, center, and surround speakers, the unit creates front VPS even if no front presence speakers are connected.

Setup menu

“Sound” > “Virtual Speaker” > “VPS”

Settings

Off	Does not create Virtual Presence Speaker (VPS).
On	Creates Virtual Presence Speaker (VPS).

NOTE

Depending on the installation height of the surround speakers, VPS may not be effective. In this case, set “VPS” to “Off”.

Related links

- “Enjoying 3-dimensional sound fields” (p.133)
- “Basic operation of the Setup menu” (p.214)

Setting Virtual Surround Back Speaker (VSBS)

Selects whether to create Virtual Surround Back Speaker (VSBS). When VSBS is enabled, the unit creates VSBS using the surround speakers even if no surround back speakers are connected.

Setup menu

“Sound” > “Virtual Speaker” > “VSBS”

Settings

Off	Does not create Virtual Surround Back Speaker (VSBS).
On	Creates Virtual Surround Back Speaker (VSBS).

NOTE

- VSBS is effective only when 6.1/7.1-channel content is played back.
- VSBS, that is working with CINEMA DSP HD³, is not available when the straight decode mode or the pure direct playback mode is enabled.

Related links

“Basic operation of the Setup menu” (p.214)

Setting Dolby Speaker Virtualization

Selects whether to create Dolby Speaker Virtualization that is virtual processing optimized for Dolby content. Dolby Speaker Virtualization is more effective with the Dolby Surround decoder.

Setup menu

“Sound” > “Virtual Speaker” > “Dolby Speaker Virtualization”

Settings

Off	Disables Dolby Speaker Virtualization.
On	Enables Dolby Speaker Virtualization.

Related links

- “Enjoying multichannel playback without sound field effects (surround decoder)” (p.141)
- “Basic operation of the Setup menu” (p.214)

Setting the jitter elimination function

Sets the jitter elimination function according to the input.

Setup menu

“Sound” > “Ultra Low Jitter PLL Mode”

Settings

Off	Disables the jitter elimination function.
Level 1, Level 2, Level 3	Enables the jitter elimination function. The higher level enhances the DAC accuracy, but it may cause audio interruptions on some playback devices. In this case, select lower level.

Related links

“Basic operation of the Setup menu” (p.214)

Setting the filter of the audio digital-to-analog converter

Selects the digital filter type of the audio digital-to-analog converter to have favorite sounds.

Setup menu

“Sound” > “DAC Digital Filter”

Settings

Sharp Roll-off Type	A tendency to produce clear sounds. Removes out-of-band noises by the filter with steep attenuation characteristics.
Slow Roll-off Type	A tendency to produce soft sounds. Removes out-of-band noises by the filter with gentle attenuation characteristics.
Short Latency Type	A tendency to produce responsive and rhythmical sounds. Reduces the audio delay caused by the DAC internal digital filter.

Related links

“Basic operation of the Setup menu” (p.214)

Setting the attenuator for the balance input

Sets the attenuator for the balance input.

Activate the attenuator when connecting an audio device which outputs signals of 3 V (RMS) or higher to the balance input jacks (AUDIO 4). The signal level is reduced and you can avoid sound distortion when high-level signals are input.

Setup menu

“Sound” > “Balance Input Attenuator”

Settings

Bypass	Does not activate the attenuator for the balance input.
ATT.(-6dB)	Activates the attenuator for the balance input. The signal level is reduced (-6dB).

Related links

“Basic operation of the Setup menu” (p.214)

Setting DTS Format Notification

Informs the BD player about the DTS formats that the unit supports.

Setup menu

“Sound” > “DTS Mode”

Settings

Mode 1	Conforms to the DTS:X standard. This setting is used normally.
Mode 2	This setting is used if the BD player fails to properly output a DTS signal even when it is playing back DTS-HD or DTS:X content.

Related links

“Basic operation of the Setup menu” (p.214)

Configuring the scene settings

Selecting items to be included as the scene assignments

Selects items to be included as the scene assignments. You can also view the settings currently assigned to the selected scene.

Setup menu

“Scene” > “Scene Setting”

1 Select the **SCENE** name and press **ENTER**.

2 Select an item and press **ENTER**.

The checked item is included. The unchecked item is excluded.

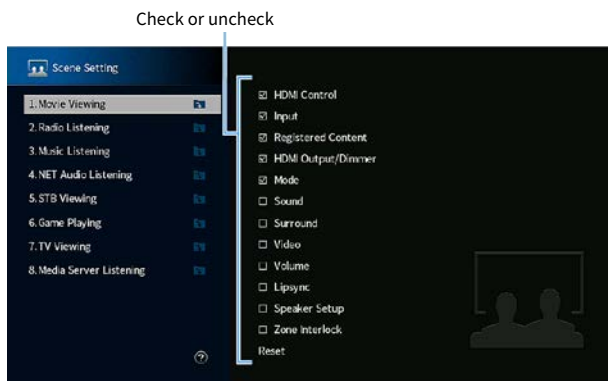

NOTE

- To restore the default settings for the selected scene, select “Reset” and press ENTER.
- To use HDMI Control and synchronized operations, you need to configure the HDMI settings on the unit.

Related links

- “Setting the use of HDMI Control” (p.275)
- “Registering a scene” (p.178)
- “Basic operation of the Setup menu” (p.214)

Renaming the SCENE name

Changes the SCENE name displayed on the front display or on the TV.

Setup menu

“Scene” > “Scene Rename”

1 Select the SCENE name and press ENTER to enter the name edit screen.

2 Edit the name.

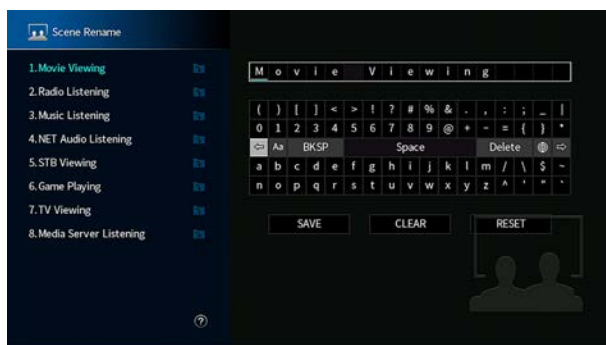

3 Select “SAVE”.

4 Press SETUP.

This completes the settings.

NOTE

- To clear the entry, select “CLEAR”.
- To restore the default name, select “RESET”.

Related links

“Basic operation of the Setup menu” (p.214)

Configuring the video/HDMI settings

Checking the HDMI signal information

Displays information about the HDMI signal.

Setup menu

“Video/HDMI” > “Information”

HDMI Signal	Resolutions and video information of HDMI input/output signal
HDMI Monitor	Resolutions supported by the TV

Related links

“Basic operation of the Setup menu” (p.214)

Setting the use of the video signal processing

Sets the video signal processing (resolution, aspect ratio and adjustment).

Setup menu

“Video/HDMI” > “Video Mode” > “Video Mode”

Settings

Direct	Disables the video signal processing.
Processing	Enables the video signal processing. The settings in “Resolution”, “Aspect” and “Adjustment” are applied.

NOTE

When set to “Direct”, the unit transmits video signals with the least circuitry in order to reduce video output delay.

Related links

- “Setting a resolution to output HDMI video signals” (p.272)
- “Setting an aspect ratio to output HDMI video signals” (p.273)
- “Setting the video adjustments to output HDMI video signals” (p.274)
- “Basic operation of the Setup menu” (p.214)

Setting a resolution to output HDMI video signals

Selects a resolution to output HDMI video signals when “Video Mode” in the “Setup” menu is set to “Processing”.

Setup menu

“Video/HDMI” > “Video Mode” > “Resolution”

Settings

Through	Does not convert the resolution.
Auto	Selects a resolution automatically in accordance with TV resolution.
480p/576p, 720p, 1080i, 1080p, 4K, 8K	Outputs video signals with a selected resolution. Only the resolutions supported by your TV are selectable.

Related links

- “Setting the use of the video signal processing” (p.271)
- “Video conversion table” (p.430)
- “Basic operation of the Setup menu” (p.214)

Setting an aspect ratio to output HDMI video signals

Selects an aspect ratio (the ratio of the width and the height) to output HDMI video signals when “Video Mode” in the “Setup” menu is set to “Processing”.

Setup menu

“Video/HDMI” > “Video Mode” > “Aspect”

Settings

Through	Does not convert the aspect ratio.
16:9 Normal	Outputs 4:3 video signals to a 16:9 TV with black bands on either side of the screen.

NOTE

This setting functions only when 480i/576i or 480p/576p signals are converted into 720p, 1080i, 1080p, or 2160p (4K) signals.

Related links

- “Setting the use of the video signal processing” (p.271)
- “Basic operation of the Setup menu” (p.214)

Setting the video adjustments to output HDMI video signals

Configures the video adjustments to output HDMI video signals when “Video Mode” in the “Setup” menu is set to “Processing”. You can register the video adjustments as presets (up to 6).

Setup menu

“Video/HDMI” > “Video Mode” > “Adjustment”

Settings

Detail Enhancement	0 to 50	Adjusts the enhancement effect of video details.
Edge Enhancement	0 to 50	Adjusts the enhancement effect of video edges.
Brightness	-100 to +100	Adjusts the video brightness.
Contrast	-100 to +100	Adjusts the video contrast (difference of brightness and darkness).
Saturation	-100 to +100	Adjusts the video saturation.

- 1 Select a preset number.**
- 2 Select an item and a setting.**
- 3 To exit from the menu, press SETUP.**

NOTE

The video adjustments work on the video signals with 1080p or lower resolution.

Related links

- “Setting the use of the video signal processing” (p.271)
- “Basic operation of the Setup menu” (p.214)

Setting the use of HDMI Control

Selects whether to use HDMI Control which operate HDMI Control-compatible devices.

Setup menu

“Video/HDMI” > “HDMI Control” > “HDMI Control”

Settings

Off	Disables HDMI Control.
On	Enables HDMI Control. The settings in “ARC” and “Standby Sync” are applied.

NOTE

You need to perform the HDMI Control link setup after connecting HDMI Control-compatible devices.

Related links

“Basic operation of the Setup menu” (p.214)

Setting the use of ARC

Selects whether to output TV audio to the speakers connected to the unit when “HDMI Control” in the “Setup” menu is set to “On”.

Setup menu

“Video/HDMI” > “HDMI Control” > “ARC”

Settings

Off	Disables ARC.
On	Enables ARC.

NOTE

You do not need to change “On” (default setting) normally. In case noises are produced because TV audio signals input to the unit are not supported by the unit, set to “Off”. And use the TV’s speakers.

Related links

- “Setting the use of HDMI Control” (p.275)
- “Basic operation of the Setup menu” (p.214)

Linking the standby modes of the unit and the TV

Selects whether to use HDMI control to link the unit's standby mode to the TV's power when "HDMI Control" in the "Setup" menu is set to "On".

Setup menu

"Video/HDMI" > "HDMI Control" > "Standby Sync"

Settings

Off	Does not link the unit's standby mode.
On	Sets the unit to standby mode when the TV is turned off.
Auto	Sets the unit to standby mode when the TV is turned off only when the unit is receiving TV audio or HDMI signals.

Related links

- "Setting the use of HDMI Control" (p.275)
- "Basic operation of the Setup menu" (p.214)

Setting the output of HDMI audio to the TV's speakers

Selects whether to output HDMI audio to the speakers of a TV connected via the HDMI OUT jack.

Setup menu

"Video/HDMI" > "HDMI Audio Output" > "HDMI OUT1"/"HDMI OUT2"/"HDMI ZONE OUT"

Settings

Off	Disables audio output from the TV.
On	Enables audio output from the TV.

NOTE

The "HDMI OUT1" setting is available only when "HDMI Control" in the "Setup" menu is set to "Off".

Related links

- "Setting the use of HDMI Control" (p.275)
- "Basic operation of the Setup menu" (p.214)

Setting the zone assignment of the HDMI out jack

Selects the zone for which the HDMI OUT 3 (ZONE OUT) jack is used.

Setup menu

“Video/HDMI” > “HDMI ZONE OUT Assign”

Input sources

Zone2, Zone4

NOTE

Audio signals that can be output to each zone vary depending on the input audio signal type.

Related links

- “Multi-zone output” (p.428)
- “Basic operation of the Setup menu” (p.214)

Setting the version of HDCP used on the HDMI input jacks

Selects the HDCP version of the HDMI input jacks. You can set this function for watching 4K/8K video content if necessary. This setting is applied separately to each HDMI input jack.

Setup menu

“Video/HDMI” > “HDCP Version” > (HDMI input)

Settings

Auto	Automatically sets the version of HDCP according to content.
1.4	Sets the version of HDCP to always be 1.4.

Related links

“Basic operation of the Setup menu” (p.214)

Setting the use of HDMI Standby Through

Selects whether to output video/audio, which is input through HDMI jacks, to the TV when the unit is in standby mode.

Setup menu

“Video/HDMI” > “HDMI Standby Through”

Settings

Off	Does not output video/audio to the TV.
On	Outputs video/audio to the TV. The unit consumes more power than when “Off” or “Auto” is selected.
Auto	Automatically selects whether to output video/audio depending on the status of the connected device.

NOTE

“Off” is not selectable when “HDMI Control” is set to “On”.

Related links

- “Setting the use of HDMI Control” (p.275)
- “Basic operation of the Setup menu” (p.214)

Setting the HDMI 4K/8K signal format

Selects the format of signals input/output at the unit when HDMI 4K/8K compatible TV and playback device are connected to the unit. This setting is applied separately to each HDMI input jack.

Setup menu

“Video/HDMI” > “HDMI Video Format” > (HDMI input)

Settings

4K Mode 1	Inputs/outputs 4K signals shown in the following table.
4K Mode 2	Inputs/outputs 4K signals shown in the following table.
8K Mode	Inputs/outputs 4K/8K signals shown in the following table.

Format

		4K Mode 1			4K Mode 2			8K Mode		
		8-bit	10-bit	12-bit	8-bit	10-bit	12-bit	8-bit	10-bit	12-bit
8K/60, 50 Hz	RGB 4:4:4	-			-			●		
	YCbCr 4:4:4	-			-			●		
	YCbCr 4:2:2	-			-			●		
	YCbCr 4:2:0	-			-			○		●
8K/30, 25, 24 Hz	RGB 4:4:4	-			-			○		●
	YCbCr 4:4:4	-			-			○		●
	YCbCr 4:2:2	-			-			○		
	YCbCr 4:2:0	-			-			○		
4K/120, 100 Hz	RGB 4:4:4	-			-			○		●
	YCbCr 4:4:4	-			-			○		●
	YCbCr 4:2:2	-			-			○		
	YCbCr 4:2:0	○		-	-			○		
4K/60, 50 Hz	RGB 4:4:4	○		-	-			○		
	YCbCr 4:4:4	○		-	-			○		
	YCbCr 4:2:2	○			-			○		
	YCbCr 4:2:0	○			○		-	○		
4K/30, 25, 24 Hz	RGB 4:4:4	○			○		-	○		
	YCbCr 4:4:4	○			○		-	○		
	YCbCr 4:2:2	○			○			○		

* “○” means supported video format.

* “●” means that only DSC (Display Stream Compression) video format is supported. DSC is a video compression technique standardized by VESA.

NOTE

- Depending on the connected device or HDMI cables, video may not be displayed correctly. In this case, select another format.
- When “8K Mode” is selected, use a Ultra High Speed HDMI Cable or Ultra High Speed HDMI Cable with Ethernet.
- When “4K Mode 1” is selected, use a Premium High Speed HDMI Cable or Premium High Speed Cable with Ethernet.

CONFIGURATIONS > Configuring various functions (Setup menu)

Related links

“Basic operation of the Setup menu” (p.214)

Configuring the network settings

Checking the network information of the unit

Displays the network information of the unit.

Setup menu

“Network” > “Information”

DHCP	DHCP on/off (use of a DHCP server or not)
IP Address	IP address
Subnet Mask	Subnet mask
Default Gateway	The IP address of the default gateway
DNS Server (P)	The IP address of the primary DNS server
DNS Server (S)	The IP address of the secondary DNS server
MAC Address (Ethernet)	MAC address
MAC Address (Wi-Fi)	
Network Name	Network name (the unit's name on the network)
MusicCast Network	The status of the MusicCast network connection.
Wired/Wireless	The status of the wired or wireless connection
SSID	(When using wireless [Wi-Fi] network connection) The SSID of the wireless network

Related links

“Basic operation of the Setup menu” (p.214)

Setting the network connection method (Wired/Wireless)

Selects the network connection method.

Setup menu

“Network” > “Network Connection”

Choices

Wired	Connects the unit to a network with a network cable.
Wireless(Wi-Fi)	Connects the unit to a network via the wireless router (Wi-Fi).

Related links

- “Network connection of the unit” (p.101)
- “Selecting a wireless network connection method” (p.414)
- “Basic operation of the Setup menu” (p.214)

Setting the network parameters automatically (DHCP)

Sets the network parameters (such as IP address, Subnet Mask, and Default Gateway) automatically using a DHCP server.

Setup menu

“Network” > “IP Address” > “DHCP”

Settings

Off	Does not use a DHCP server. You can configure the network parameters manually.
On	Uses a DHCP server. The unit's network parameters are configured automatically.

Related links

“Basic operation of the Setup menu” (p.214)

Setting the network parameters manually

Sets the network parameters (such as IP address, Subnet Mask, and Default Gateway) manually.

Setup menu

“Network” > “IP Address”

- 1 Set “DHCP” to “Off”.**
- 2 Select “IP Address”.**
- 3 Select a parameter type.**
- 4 Set the network parameter.**
- 5 Press ENTER.**
- 6 To set another parameter, repeat steps 3 to 5.**
- 7 Press SETUP.**

This completes the settings.

Related links

“Basic operation of the Setup menu” (p.214)

Setting the use of the Network Standby function

Selects whether the unit can be turned on from other network devices.

Setup menu

“Network” > “Network Standby”

Settings

Off	Disables the network standby function.
On	Enables the network standby function. The unit consumes more power than when “Off” is selected.
Auto	Enables the network standby function. If “Network Connection” is set to “Wired”, the unit is set to the power saving mode when the network cable is disconnected and the power consumption is suppressed.

NOTE

- If you set “Network Standby” to “Off”, “Bluetooth Standby” will be disabled.
- In the power saving mode, the unit cannot be turned on from other network devices when the network cable is connected again. Turn on the unit manually.



With an advanced energy saving design, this product achieves a low power consumption of not more than 1.8 watts when in Network Standby mode.

Related links

- “Setting the network connection method (Wired/Wireless)” (p.285)
- “Setting the use of the Bluetooth® Standby function” (p.295)
- “Basic operation of the Setup menu” (p.214)

Setting the use of a Digital Media Controller

Selects whether to allow a Digital Media Controller (DMC) to control playback. If this function is enabled, you can control playback of the unit from DMCs on the same network.

Setup menu

“Network” > “DMC Control”

Settings

Disable	Does not allow DMCs to control playback.
Enable	Allows DMCs to control playback.

Related links

“Basic operation of the Setup menu” (p.214)

Setting the use of volume control via AirPlay

Selects whether to use volume control from AirPlay devices. If other than “Off” is set, you can adjust the unit’s volume from the AirPlay devices.

Setup menu

“Network” > “AirPlay Volume Interlock”

Settings

Off	Disables volume control from AirPlay devices.
Limited	Enables volume control from AirPlay devices within the limited range (-80.0 dB to -20.0 dB [0.5 to 60.5] and mute).
Full	Enables volume control from AirPlay devices in the full range (-80.0 dB to +16.5 dB [0.5 to 97.0] and mute).

Related links

“Basic operation of the Setup menu” (p.214)

Setting the network name of the unit

Edits the unit's name on the network (the network name) displayed on other network devices.

Setup menu

“Network” > “Network Name”

- 1 Press ENTER.**
- 2 Edit the name.**
- 3 Select “SAVE”.**
- 4 Press SETUP.**

This completes the settings.

NOTE

- To clear the entry, select “CLEAR”.
- To restore the default network name, select “RESET”.

Related links

“Basic operation of the Setup menu” (p.214)

Setting the power interlock from the unit to MusicCast compatible devices

Selects whether turning on the power of the unit (the master device) also turns on the power of other devices (the slave device) of the MusicCast network.

Setup menu

“Network” > “MusicCast Link Power Interlock”

Settings

Off	Disables the power interlock from the unit to MusicCast compatible devices.
On	Enables the power interlock from the unit to MusicCast compatible devices.

Related links

“Basic operation of the Setup menu” (p.214)

Configuring the Bluetooth® settings

Setting the use of Bluetooth®

Selects whether to use the Bluetooth function.

Setup menu

“Bluetooth” > “Bluetooth”

Settings

Off	Disables the Bluetooth function.
On	Enables the Bluetooth function.

Related links

“Basic operation of the Setup menu” (p.214)

Terminating the connection between a Bluetooth® device and the unit

Terminates the Bluetooth connection between a Bluetooth device (such as a smartphone) and the unit. Select “Disconnect” and press ENTER to terminate the Bluetooth connection.

Setup menu

“Bluetooth” > “Audio Receive” > “Disconnect”

NOTE

This setting is not available when no Bluetooth devices are connected.

Related links

“Basic operation of the Setup menu” (p.214)

Setting the use of the Bluetooth® Standby function

Selects whether to turn on the unit from Bluetooth devices. If this function is set to “On”, the unit automatically turns on when a connect operation is performed on the Bluetooth device.

Setup menu

“Bluetooth” > “Audio Receive” > “Bluetooth Standby”

Settings

Off	Disables the Bluetooth standby function.
On	Enables the Bluetooth standby function. The unit consumes more power than when “Off” is selected.

NOTE

This setting is not available when “Network Standby” is set to “Off”.

Related links

- “Setting the use of the Network Standby function” (p.288)
- “Basic operation of the Setup menu” (p.214)

Setting the use of volume control via Bluetooth

Selects whether to use volume control from Bluetooth devices. If other than “Off” is set, you can adjust the unit’s volume from the Bluetooth devices.

Setup menu

“Bluetooth” > “Audio Receive” > “Bluetooth Volume Interlock”

Settings

Off	Disables volume control from Bluetooth devices.
Limited	Enables volume control from Bluetooth devices within the limited range (-80.0 dB to -20.0 dB [0.5 to 60.5] and mute).
Full	Enables volume control from Bluetooth devices in the full range (-80.0 dB to +16.5 dB [0.5 to 97.0] and mute).

NOTE

Some Bluetooth devices may not control the unit’s volume.

Related links

“Basic operation of the Setup menu” (p.214)

Setting the use of audio transmission to a Bluetooth® device

Selects whether to transmit audio played back on the unit to Bluetooth devices (such as speakers and headphones).

Setup menu

“Bluetooth” > “Audio Send” > “Transmitter”

Settings

Off	Disables the Bluetooth audio transmitter function.
On	Enables the Bluetooth audio transmitter function.

Related links

- “Connecting the unit to a Bluetooth® device that receives transmitted audio” (p.298)
- “Basic operation of the Setup menu” (p.214)

Connecting the unit to a Bluetooth® device that receives transmitted audio

Establishes a connection between the unit and Bluetooth devices (such as speakers and headphones) that receive audio transmitted from the unit when "Transmitter" is set to "On" in the "Setup" menu.

Setup menu

"Bluetooth" > "Audio Send" > "Device Search"

1 Confirm the message and press ENTER.

A list of Bluetooth devices that can connect to the unit is displayed.

2 Select the list.

3 Select the Bluetooth speakers/headphones to be connected with the unit.

A check mark is put on the desired device.

4 Select "CONNECT".

When the connection process finishes, "Completed" is displayed.

5 Select "OK".

This completes the settings.

NOTE

- If the desired Bluetooth device is not displayed on the list, set the Bluetooth device to pairing mode and then perform "Device Search" operation again.
- To terminate the Bluetooth connection, perform a disconnect operation on the Bluetooth speakers/headphones.

Related links

- "Setting the use of audio transmission to a Bluetooth® device" (p.297)
- "Basic operation of the Setup menu" (p.214)

Configuring the multi zone settings

Checking the zone information

Displays information about zone.

Setup menu

“Multi Zone” > “Information”

On/Off	The power on/off for zone
Input	The input source selected for zone
Volume	The volume setting for zone
Tone Control	The tone control setting (the level of Treble and Bass) for zone

Related links

“Basic operation of the Setup menu” (p.214)

Setting the use of volume adjustments for zone output

Sets volume adjustments for zone output.

If you have connected an external amplifier with volume control to the unit, set this function to “Fixed”.

Setup menu

“Multi Zone” > (zone) > “Volume”

Settings

Fixed	Disables volume adjustments for zone output.
Variable	Enables volume adjustments for zone output.

NOTE

This setting is not available depending on the setting in “Power Amp Assign”.

Related links

- “Setting your speaker system” (p.226)
- “Basic operation of the Setup menu” (p.214)

Setting the zone upper limit of the volume

Sets the zone upper limit of the volume adjusted by using such as VOLUME keys on the remote control.

Setup menu

“Multi Zone” > (zone) > “Max Volume”

Setting range

-60.0 dB to +15.0 dB, +16.5 dB [20.5 to 95.5, 97.0]

NOTE

This setting is available only when “Volume” is set to “Variable”.

Related links

- “Setting the use of volume adjustments for zone output” (p.300)
- “Basic operation of the Setup menu” (p.214)

Setting the zone initial volume for when the unit is turned on

Sets the zone initial volume for when the unit is turned on.

Setup menu

“Multi Zone” > (zone) > “Initial Volume”

Settings

Off		Sets the level at the volume level when it last entered standby mode.
	Mute	Mutes the audio output.
On	-80.0 dB to +16.5 dB [0.5 to 97.0]	Sets the level to the specified volume level. This setting works only when the volume level is set lower than “Max Volume”.

NOTE

This setting is available only when “Volume” is set to “Variable”.

Related links

- “Setting the use of volume adjustments for zone output” (p.300)
- “Setting the zone upper limit of the volume” (p.301)
- “Basic operation of the Setup menu” (p.214)

Adjusting the time deviation in relation to the Main zone

Adjusts the time deviation (Audio Delay) in relation to the Main zone.

Setup menu

“Multi Zone” > (zone) > “Audio Delay”

Setting range

0 ms to 100 ms

Related links

“Basic operation of the Setup menu” (p.214)

Setting the use of monaural sounds for zone output

Selects whether to produce monaural sounds for zone output.

Setup menu

“Multi Zone” > (zone) > “Monaural”

Settings

Off	Does not produce monaural sounds in zone.
On	Produces monaural sounds in zone.

Related links

“Basic operation of the Setup menu” (p.214)

Setting the use of Compressed Music Enhancer for zone output

Sets Compressed Music Enhancer for zone output. You can also use ENHANCER on the remote control.

Setup menu

“Multi Zone” > (zone) > “Enhancer”

Settings

Off	Disables Compressed Music Enhancer.
On	Enables Compressed Music Enhancer.

Related links

“Basic operation of the Setup menu” (p.214)

Adjusting the tone for zone output

Adjusts the level of high-frequency range (Treble) and low-frequency range (Bass) for zone output.

Setup menu

“Multi Zone” > (zone) > “Tone Control”

Settings

Auto	Adjusts the levels of Treble and Bass automatically in synchronization with the main volume.
Manual	Adjusts the level of Treble and Bass manually. The adjusting range is -6.0 dB to +6.0 dB.
Bypass	Does not adjust the level of Treble and Bass.

Related links

“Basic operation of the Setup menu” (p.214)

Setting the use of Extra Bass for zone output

Sets Extra Bass for zone output. If Extra Bass is enabled, you can enjoy sufficient bass sounds, regardless of the size of speakers.

Setup menu

“Multi Zone” > (zone) > “Extra Bass”

Settings

Off	Disables Extra Bass.
On	Enables Extra Bass.

Related links

“Basic operation of the Setup menu” (p.214)

Adjusting the volume balance for zone output

Adjusts the volume balance for zone output. Higher value enhances the right side volume, and lower value enhances the left side volume.

Setup menu

“Multi Zone” > (zone) > “Left / Right Balance”

Setting range

-20 to +20

Related links

“Basic operation of the Setup menu” (p.214)

Renaming the zone name

Changes the zone name displayed on the TV.

Setup menu

“Multi Zone” > “Zone Rename”

1 Select a zone name to be renamed.

The cursor moves to the name edit screen.

2 Edit the name.

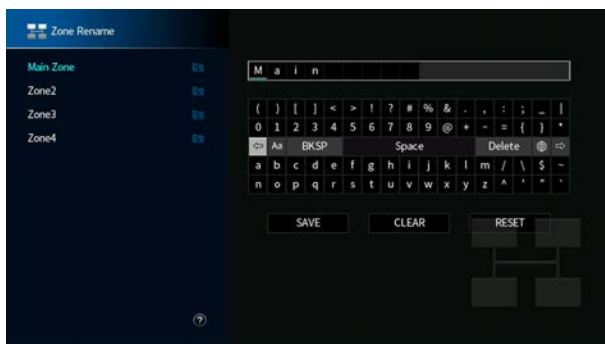

3 Select “SAVE”.

4 Press SETUP.

NOTE

- To clear the entry, select “CLEAR”.
- To restore the default name, select “RESET”.

Related links

“Basic operation of the Setup menu” (p.214)

Setting the use of switching to the party mode on zone

Enables switching to the party mode.

Setup menu

“Multi Zone” > “Party Mode Set” > (target zone)

Settings

Disable	Disables switching to the party mode.
Enable	Enables switching to the party mode. You can turn on/off the party mode by pressing PARTY on the remote control.

NOTE

When the party mode is turned on, you cannot change the settings.

Related links

- “Enjoying the same source in multiple rooms (party mode)” (p.190)
- “Basic operation of the Setup menu” (p.214)

Configuring the system settings

Checking the system information on the unit

Displays the system information on the unit.

Setup menu

“System” > “Information”

Remote Sensor	The use of the remote control on the front panel
Remote ID	The unit's remote control ID setting
System ID	System ID number
Firmware Version	The version of firmware installed on the unit

Related links

“Basic operation of the Setup menu” (p.214)

Setting the menu language

Selects the menu language such as the Setup menu.

Setup menu

“System” > “Language”

Settings

English	English
日本語	Japanese
Français	French
Deutsch	German
Español	Spanish
Русский	Russian
Italiano	Italian
中文	Chinese

Related links

“Basic operation of the Setup menu” (p.214)

Combining an audio input jack with a HDMI input jack

Selects the audio input jack to play back together with a HDMI input jack. You can play back HDMI video with audio via an audio input jack except HDMI input jack.

After select HDMI you want to set as the input source, select an audio input jack in this menu.

Setup menu

“System” > “Audio In”

Settings

AUDIO 1-4

Video/audio input jacks on the unit

Output jacks on video device		Input jacks on the unit	
Video	Audio	Video	Audio
HDMI	Digital optical	HDMI 1-7	AUDIO 1-2
	Digital coaxial		AUDIO 3
	Analog stereo (RCA)		AUDIO 2-3
	Analog stereo (XLR)		AUDIO 4

Related links

“Basic operation of the Setup menu” (p.214)

Setting the audio input jack used for TV audio

Selects an audio input jack, which connected to TV audio output, of the unit.

When you switch the input source of the unit to “TV”, the playback of TV audio is as follows.

- Without eARC/ARC function: the TV audio is played back with the audio input jack set for TV audio in “TV Audio Input”.
- With eARC/ARC function: the TV audio is played back with eARC/ARC, regardless of setting in “TV Audio Input”.

When using ARC function, set “HDMI Control” and “ARC” in the “Setup” menu to “On”.

When using eARC function, you do not have to set the ARC function. “HDMI Control” is set if necessary.

Setup menu

“System” > “TV Audio Input”

Settings

AUDIO 1-3

NOTE

You may need setting on the TV. Refer to the instruction manual for the TV.

Related links

- “Setting the use of HDMI Control” (p.275)
- “Setting the use of ARC” (p.276)
- “Basic operation of the Setup menu” (p.214)

Setting input sources to be skipped when operating the INPUT key

Sets which input sources are skipped when operating the INPUT key. You can select the desired input source quickly by using this function.

Setup menu

“System” > “Input Skip” > (input)

Settings

Off	Does not skip the selected input source.
On	Skips the selected input source.

Related links

“Basic operation of the Setup menu” (p.214)

Automatically setting the input source names

Automatically sets the input source names depending on the connected external device.

The name is created automatically only when the unit can get the information about the connected external device from the input source (such as HDMI).

Setup menu

“System” > “Input Rename” > (input)

- 1 Select an input source to be renamed.**
- 2 Select “Auto”.**
- 3 To change another input source name, repeat steps 1 to 2.**
- 4 Press SETUP.**

This completes the settings.

NOTE

When “Auto” is selected, the created name is saved even after the external device is disconnected. To reset to the default setting, with no connection to the corresponding input jack, switch the setting to “Manual” and then back to “Auto”.

Related links

“Basic operation of the Setup menu” (p.214)

Manually setting the input source names

Manually sets the input source names.

Setup menu

“System” > “Input Rename” > (input)

- 1 Select an input source to be renamed.**
- 2 Select “Manual”.**
- 3 Press ENTER.**
- 4 Edit the name.**
- 5 Select “SAVE”.**
- 6 To change another input source name, repeat steps 1 to 5.**
- 7 Press SETUP.**

This completes the settings.

NOTE

- To cancel the entry, select “CLEAR”.
- To restore the default name, select “RESET”.

Related links

“Basic operation of the Setup menu” (p.214)

Setting the use of Auto Play function

Selects whether to use Auto Play function in the content such as streaming services.

Setup menu

“System” > “Auto Play”

Settings

Off	Disables Auto Play function.
On	Starts automatically to play back the last content which you played back.
Auto	Starts automatically to play back the content which only you played back at setting the unit to standby mode.

NOTE

- In some input sources, you might not select “On” or “Auto”.
- In some input sources or content, you might not enable Auto Play function.

Related links

“Basic operation of the Setup menu” (p.214)

Setting sound programs to be skipped when operating the PROGRAM keys

Sets which sound programs are skipped when operating the PROGRAM keys. You can select the desired sound program quickly by using this function.

Setup menu

“System” > “DSP Skip”

Settings

Off	Does not skip the selected sound program.
On	Skips the selected sound program.

NOTE

This setting is applied separately to each sound program.

Related links

“Basic operation of the Setup menu” (p.214)

Changing the FM/AM tuning frequency setting

Model For

Asia, Taiwan, Brazil, General, and Central and South America

Sets the FM/AM tuning frequency setting of the unit depending on your country or region.

Setup menu

“System” > “Tuner” > “Frequency Step”

Settings

FM100/AM10	Adjusts the FM frequency by 100-kHz steps and AM by 10-kHz steps.
FM50/AM9	Adjusts the FM frequency by 50-kHz steps and AM by 9-kHz steps.

NOTE

Preset (registered radio stations) and frequency will be initialized if you change the radio tuning frequency steps.

Related links

“Basic operation of the Setup menu” (p.214)

Setting the function for the PROGRAM keys on the remote control

Sets the function that is assigned to the PROGRAM keys on the remote control. You can use the PROGRAM keys for other than the sound program selection.

Setup menu

“System” > “Remote Key” > “PROGRAM Key”

Settings

Assign1	Enables selecting the DSP Programs.
	Enables selecting just the DSP Movie/Music Programs.
Assign2	The up key of the PROGRAM keys: toggle between programs in the “MOVIE” category The down key of the PROGRAM keys: toggle between programs in the “MUSIC” category
Assign3	Enables selecting the NETWORK sources.
Assign4	Enables moving to the previous/next page of the browse screen.
Assign5	Enables fine-adjusting the subwoofer volume.
Assign6	Enables adjusting the volume of dialogue sounds.
	Enables selecting shuffle/repeat settings.
Assign7	The up key of the PROGRAM keys: repeat The down key of the PROGRAM keys: shuffle
	Displays the on-screen information.
Assign8	The up key of the PROGRAM keys: displaying the current status information on the TV The down key of the PROGRAM keys: closing the current status information on the TV

NOTE

Depending on this setting, the PROGRAM keys may be also available in zone.

Related links

“Basic operation of the Setup menu” (p.214)

Setting the functions for the color keys on the remote control

Sets the functions for the RED/GREEN/YELLOW/BLUE keys on the remote control.

Setup menu

“System” > “Remote Key” > “Color Key”

Settings

Default	<p>Assigns the functions of devices connected to the unit with an HDMI cable.</p> <p>This setting is effective when “HDMI Control” in the “Setup” menu is set to “On”.</p>
TV Control	<p>Assigns the functions of TV Control to each key.</p> <p>RED: EXIT (closes the menu on the TV)</p> <p>GREEN: INFO (displays information about the TV such as the resolution)</p> <p>YELLOW: BROADCAST (switches the TV broadcast type)</p> <p>BLUE: INPUT (switches the TV input)</p> <p>This setting is effective when “HDMI Control” in the “Setup” menu is set to “On”.</p>
Display Control	<p>Assigns the functions of Display Control to each key.</p> <p>RED: Dimmer- (darkens the front display and indicators)</p> <p>GREEN: Dimmer+ (brightens the front display and indicators)</p> <p>YELLOW: Display item - (displays the previous information on the front display)</p> <p>BLUE: Display item + (displays the next information on the front display)</p>

NOTE

- To use HDMI control, you need to perform the HDMI Control link setup after connecting HDMI Control-compatible devices when this function is set to “Default” or “TV Control”.
- HDMI Control and HDMI Control link function might not work properly when this function is set to “Default” or “TV Control”.

Related links

- “Setting the use of HDMI Control” (p.275)
- “Adjusting the brightness of the front display” (p.323)
- “Selecting the input information displayed on the front display” (p.29)
- “Basic operation of the Setup menu” (p.214)

Adjusting the brightness of the front display

Adjusts the brightness of the following on the front panel. Higher value brightens the front display.

- Front display
- Indicators (SURROUND:AI, ZONE, PURE DIRECT)

Setup menu

“System” > “Display Settings” > “Dimmer”

Front Display menu

“Dimmer”

Setting range

-5 to 0

NOTE

- The front display is turned off by “-5”. The default setting is “-2”.
- Though you set “Dimmer” to “-5”, short message and menu on the front display will be displayed in brightness “-4”.
- If you set “Dimmer” to “-5”, it is incomprehensible that the power of the unit is set to on. Pay attention to forget to turn off the unit. We recommend setting “Auto Power Standby” in the “Setup” menu to besides “Off”.
- The setting brightness may become dark when “ECO Mode” is set to “On”.
- The setting of “Dimmer” in the “Setup” menu is interlocked with the setting of “Dimmer” in the “Front Display” menu.
- You can set “Dimmer” using the color keys on the remote control when “Remote Color Key” in the “Setup” menu is set to “Display Control”.

Related links

- “Setting the functions for the color keys on the remote control” (p.322)
- “Setting the amount of time for the auto-standby function” (p.333)
- “Setting the use of the eco mode” (p.334)
- “Basic operation of the Setup menu” (p.214)
- “Basic operation of the Front Display menu” (p.339)

Setting the scale of the volume display

Switches the scale of the volume display.

Setup menu

“System” > “Display Settings” > “Volume”

Settings

dB	The “dB” unit
0-97	The numeric value (0-97)

Related links

“Basic operation of the Setup menu” (p.214)

Setting the use of short messages on the TV

Selects whether to display short messages on the TV when the unit is operated.

Setup menu

“System” > “Display Settings” > “Short Message”

Settings

Off	Does not display short messages.
On	Displays short messages.

Related links

“Basic operation of the Setup menu” (p.214)

Setting the position of short messages

Sets the position of short messages on the TV screen.

Setup menu

“System” > “Display Settings” > “Short Message” > “Position”

Settings

Bottom	Displays short messages at the bottom of the TV screen.
Top	Displays short messages at the top of the TV screen.

NOTE

This setting is available only when “Short Message” in the “Setup” menu is set to “On”.

Related links

“Basic operation of the Setup menu” (p.214)

Setting the image to be used as wallpaper on the TV

Selects the image to be used as wallpaper on the TV.

Setup menu

“System” > “Display Settings” > “Wallpaper”

Settings

Type 1-3

Related links

“Basic operation of the Setup menu” (p.214)

Setting the operation sound

Selects whether to ring a sound when operating the touch key on the front panel.

Setup menu

“System” > “Touch Sound”

Settings

Off	Does not output the operation sound.
On	Outputs the operation sound.

NOTE

This setting is interlocked with the setting of “Touch Sound” in the “Front Display” menu.

Related links

- “Setting the use of the operation sound” (p.346)
- “Basic operation of the Setup menu” (p.214)

Specifying the condition for the TRIGGER OUT jack to function

Specifies the condition for the TRIGGER OUT jack functions which make the external devices synchronize with the unit.

Setup menu

“System” > “Trigger Output1”/“Trigger Output2” > “Trigger Mode”

Settings

Power	Synchronizes transmitting/stopping the electronic signal with the power status of the zone specified with “Target Zone”.
Source	Synchronizes transmitting/stopping the electronic signal with the input switching in the zone specified with “Target Zone”. An electronic signal is transmitted according to the setting.
Manual	Sets transmitting/stopping the electronic signal manually.

Related links

- “Specifying the zone with which the TRIGGER OUT jack functions are synchronized” (p.332)
- “Specifying the output level of the electronic signal transmitted with each input” (p.330)
- “Switching the output level for electronic signal transmission manually” (p.331)
- “Basic operation of the Setup menu” (p.214)

Specifying the output level of the electronic signal transmitted with each input

Specifies the output level of the electronic signal transmitted with each input when “Trigger Mode” is set to “Source”.

Setup menu

“System” > “Trigger Output1”/“Trigger Output2” > “Trigger Mode” > “Source” > (input)

Settings

Low	Stops the electronic signal transmission when you switch to the input source specified in this option.
High	Transmits the electronic signal when you switch to the input source specified in this option.

Related links

“Basic operation of the Setup menu” (p.214)

Switching the output level for electronic signal transmission manually

Switches the output level for electronic signal transmission manually when “Trigger Mode” is set to “Manual”. This setting can be used to confirm proper function of the external device connected via the TRIGGER OUT jack.

Setup menu

“System” > “Trigger Output1”/“Trigger Output2” > “Trigger Mode” > “Manual”

Settings

Low	Stops the electronic signal transmission.
High	Transmits 12 volts of electronic signal.

Related links

“Basic operation of the Setup menu” (p.214)

Specifying the zone with which the TRIGGER OUT jack functions are synchronized

Specifies the zone with which the TRIGGER OUT jack functions are synchronized when “Trigger Mode” is set to “Power” or “Source”.

Setup menu

“System” > “Trigger Output1”/“Trigger Output2” > “Target Zone”

Settings

Main	Synchronizes with the Main zone.
(zone)	Synchronizes with each zone.
All	Synchronizes with all zone.

Related links

“Basic operation of the Setup menu” (p.214)

Setting the amount of time for the auto-standby function

Sets the amount of time for setting the unit to standby mode automatically.

Setup menu

“System” > “ECO” > “Auto Power Standby”

Settings

Off	Does not set the unit to standby mode.
5 minutes, 20 minutes	Sets the unit to standby mode when you have not operated the unit and the unit has not detected any input signal for the specified time.
2 hours, 4 hours, 8 hours, 12 hours	Sets the unit to standby mode when you have not operated the unit for the specified time.

NOTE

- Just before the unit enters standby mode, the number of seconds to standby mode counts down on the front display.
- When “Dimmer” is set to “-5” (turned off), it is incomprehensible that the power of the unit is set to on. If you set “Auto Power Standby” to “Off”, pay attention to forget to turn off the unit.

Related links

“Basic operation of the Setup menu” (p.214)

Setting the use of the eco mode

Reduces the unit's power consumption by setting the eco mode. If this function is set to "On", be sure to restart the unit. New setting becomes effective after a restart.

Setup menu

"System" > "ECO" > "ECO Mode"

Settings

Off	Disables the eco mode.
On	Enables the eco mode. The front display may become dark.

NOTE

If you want to play audio at high volume, set "ECO Mode" to "Off".

Related links

"Basic operation of the Setup menu" (p.214)

Preventing accidental changes to the settings

Protects the settings to prevent accidental changes.

Setup menu

“System” > “Memory Guard”

Settings

Off	Does not protect the settings.
On	Protects the settings. Change in the setting is prohibited until “Off” is selected. The lock icon (🔒) is displayed on the menu screen.

Related links

“Basic operation of the Setup menu” (p.214)

Restoring the default settings

Restores the default settings for the unit (initialization).

Setup menu

“System” > “Initialization”

Choices

All Initialization	Restores the default settings for the unit.
Video Initialization	Restores the default settings for video configurations.
Network Initialization	Restores the default settings for network configurations.

1 Select “All Initialization”, “Video Initialization” or “Network Initialization”.

2 Press ENTER to execute the initialization.

In case of “All Initialization”, the unit will restart automatically a few seconds later.

In case of “Video Initialization” or “Network Initialization”, “Complete” is displayed on the front display when the process finishes.

NOTE

You can also restore the default settings in “Initialization” in the “Front Display” menu.

Related links

“Basic operation of the Setup menu” (p.214)

Backing up and restoring all the settings

Informs the unit's setting to a USB flash drive and restores it to the unit. Prepare a USB flash drive using FAT16 or FAT32 format in advance.

Setup menu

“System” > “Backup/Restore”

Choices

Backup	Backups all the settings for the USB flash drive.
Restore	Restores all the previous backedup settings.

1 Connect the USB flash drive to the USB jack on the front panel.

2 Select “Backup” or “Restore”.

In process, “Executing” is displayed on the TV and the front display.

When the process finishes, “Complete” is displayed on the TV (the front display). In case of “Restore”, the unit will restart automatically a few seconds later.

If “Error” appears on the TV (the front display), check the following and start the process again.

In case of “Backup”:

- You cannot save by overwriting. If you save the settings repeatedly, please move the file in different folder.
- The file is stored by the name of “MC_backup_(model name).dat” in the route of the USB flash drive.

In case of “Restore”:

- Check that the file is stored in the route of the USB flash drive.

NOTE

- “Restore” is effective after backing up all the settings.
- Do not turn off the unit during the backing up and restoring process. Otherwise, the settings may not be restored correctly.
- The user information (such as account, password) is not saved.
- You can also backup all the settings in “Backup/Restore” in the “Front Display” menu.

Related links

“Basic operation of the Setup menu” (p.214)

Updating the firmware

Updates the firmware. You can also check the firmware version and system ID.

Setup menu

“System” > “Firmware Update”

Choices

Network Update	Updates the firmware via the network.
USB Update	Updates the firmware using a USB flash drive.

NOTE

- “Network Update” is not selectable when firmware update is in preparation.
- Do not perform this menu unless firmware update is necessary. Also, make sure you confirm the information supplied with updates before updating the firmware.
- Firmware update via the network takes about 20 minutes or more.
- If the Internet connection speed is slow, or the unit is connected to the wireless network, network update may not be possible depending on the condition of the network. In this case, wait until firmware update is ready, or update the firmware using the USB flash drive.
- You can also update the firmware in “Firmware Update” in the “Front Display” menu.

Related links

- “Updating the unit’s firmware via the network” (p.355)
- “Basic operation of the Setup menu” (p.214)

Configuring the unit's settings by operation of the body front panel (Front Display menu)

Basic operation of the Front Display menu

Perform the following basic procedure to operate the "Front Display" menu. Operate this menu displayed on the front display using the front panel.

1 Touch MENU (CONNECT) on the front panel.

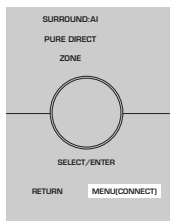

2 Select an item by using SELECT/ENTER.

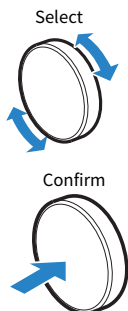

3 Select a setting.

4 Touch MENU (CONNECT).

This completes the settings.

NOTE

In the "Front Display" menu, touch RETURN on the front panel to cancel the operation or display the previous menu.

Related links

"Default settings of the Front Display menu" (p.449)

Front Display menu items

Use the following table to configure system settings of the unit.

Item	Page		
Dimmer	341		
Zone Power	342		
Settings	Volume Knob Lock	343	
	Function Lock	Input Selector Lock	344
		Scene Key Lock	345
	Touch Sound	346	
	Remote Sensor	347	
	Remote ID	348	
	Information Skip	349	
	Initialization	350	
	Backup/Restore	351	
	Firmware Update	352	
Retail Demo Mode	353		

Adjusting the brightness of the front display

Adjusts the brightness of the following on the front panel. Higher value brightens the front display.

- Front display
- Indicators (SURROUND:AI, ZONE, PURE DIRECT)

Setup menu

“System” > “Display Settings” > “Dimmer”

Front Display menu

“Dimmer”

Setting range

-5 to 0

NOTE

- The front display is turned off by “-5”. The default setting is “-2”.
- If you set “Dimmer” to “-5”, the front display will be turned off after closing the menu.
- Though you set “Dimmer” to “-5”, short message and menu on the front display will be displayed in brightness “-4”.
- If you set “Dimmer” to “-5”, it is incomprehensible that the power of the unit is set to on. Pay attention to forget to turn off the unit. We recommend setting “Auto Power Standby” in the “Setup” menu to besides “Off”.
- The setting brightness may become dark when “ECO Mode” is set to “On”.
- The setting of “Dimmer” in the “Setup” menu is interlocked with the setting of “Dimmer” in the “Front Display” menu.
- You can set “Dimmer” using the color keys on the remote control when “Remote Color Key” in the “Setup” menu is set to “Display Control”.

Related links

- “Setting the functions for the color keys on the remote control” (p.322)
- “Setting the amount of time for the auto-standby function” (p.333)
- “Setting the use of the eco mode” (p.334)
- “Basic operation of the Setup menu” (p.214)
- “Basic operation of the Front Display menu” (p.339)

Setting the power of each zone to on/standby

Switches the power of the zone to be operated between on and off (standby).

Front Display menu

“Zone Power” > (zone)

Settings

Off	Turns off the zone.
On	Turns on the zone.

Related links

“Basic operation of the Front Display menu” (p.339)

Setting the use of the volume on the front panel

Selects whether to use the volume on the front panel. You can disable the volume operation on the unit to prevent the volume from being set unexpectedly loud by a child.

Front Display menu

“Settings” > “Function Lock” > “Volume Knob Lock”

Settings

Off	Enables the volume operation on the unit.
On	Disables the volume operation on the unit.

Related links

“Basic operation of the Front Display menu” (p.339)

Setting the use of the input selector on the front panel

Selects whether to use SELECT/ENTER on the front panel as the input selector.

Front Display menu

“Settings” > “Function Lock” > “Input Selector Lock”

Settings

Off	Enables the input selection operation of SELECT/ENTER on the unit.
On	Disables the input selection operation of SELECT/ENTER on the unit.

Related links

“Basic operation of the Front Display menu” (p.339)

Setting the use of the scene key on the front panel

Selects whether to use SCENE (4 numbers) on the front panel.

Front Display menu

“Settings” > “Function Lock” > “Scene Key Lock”

Settings

Off	Enables the operation of SCENE on the unit.
On	Disables the operation of SCENE on the unit.

Related links

“Basic operation of the Front Display menu” (p.339)

Setting the use of the operation sound

Selects whether to ring a sound when operating the touch key on the front panel.

Front Display menu

“Settings” > “Touch Sound”

Settings

Off	Does not output the operation sound.
On	Outputs the operation sound.

NOTE

This setting is interlocked with the setting of “Touch Sound” in the “Setup” menu.

Related links

- “Setting the operation sound” (p.328)
- “Basic operation of the Front Display menu” (p.339)

Setting the use of the remote control

Selects whether to use the remote control sensor on the front panel.

Front Display menu

“Settings” > “Remote Sensor”

Settings

Off	Turns off the remote control sensor.
On	Turns on the remote control sensor.

NOTE

- While the remote control sensor is turned off, you cannot control the unit from the remote control. Set this function to “On” normally.
- “Remote Sensor Off” is displayed on the front display with the remote control while the remote control sensor is turned off.

Related links

“Basic operation of the Front Display menu” (p.339)

Selecting the remote control ID

Sets the unit's remote control ID so that it matches the remote control's ID. When using multiple Yamaha AV receivers, set a unique remote control ID for its corresponding receiver.

Front Display menu

"Settings" > "Remote ID"

Settings

ID1, ID2

Changing the remote control ID of the remote control

- To select ID1, while holding down the left cursor key, hold down SCENE number key 1 for 5 seconds.
- To select ID2, while holding down the left cursor key, hold down SCENE number key 2 for 5 seconds.

NOTE

If the remote control IDs of the unit and the remote control do not match, "Remote ID Mismatch" appears on the front display when the remote control is operated.

Related links

"Basic operation of the Front Display menu" (p.339)

Setting information items to be skipped when operating SELECT/ENTER

Sets which information items are skipped when operating SELECT/ENTER on the front panel. You can select the desired information quickly by using this function to skip the unnecessary information.

Front Display menu

“Settings” > “Information Skip” > (information item)

Settings

Off	Does not skip the selected information item.
On	Skips the selected information item.

NOTE

If you set this function of all information items to “On”, the first item (default) appears on the front display.

Related links

- “Selecting the input information displayed on the front display” (p.29)
- “Basic operation of the Front Display menu” (p.339)

Restoring the default settings

Restores the default settings for the unit (initialization).

Front Display menu

“Settings” > “Initialization”

Choices

All Initialization	Restores the default settings for the unit.
Video Initialization	Restores the default settings for video configurations.
Network Initialization	Restores the default settings for network configurations.

1 Select “All Initialization”, “Video Initialization” or “Network Initialization”.

2 Select “Execute”.

Reconfirmation is displayed on the front display.

3 Select “Execute”.

In case of “All Initialization”, the unit will restart automatically.

In case of “Video Initialization” or “Network Initialization”, “Complete” is displayed when the process finishes.

NOTE

You can also restore the default settings in “Initialization” in the “Setup” menu.

Related links

“Basic operation of the Front Display menu” (p.339)

Backing up and restoring all the settings

Informs the unit's setting to a USB flash drive and restores it to the unit. Prepare a USB flash drive using FAT16 or FAT32 format in advance.

Front Display menu

“Settings” > “Backup/Restore”

Choices

Backup	Backups all the settings for the USB flash drive.
Restore	Restores all the previous backedup settings.

1 Connect the USB flash drive to the USB jack on the front panel.

2 Select “Backup” or “Restore”.

3 Select “Execute”.

In process, “Executing” is displayed. When the process finishes, “Complete” is displayed. In case of “Restore”, the unit will restart automatically a few seconds later.

If “Error” appears, check the following and start the process again.

In case of “Backup”:

- You cannot save by overwriting. If you save the settings repeatedly, please move the file in different folder.
- The file is stored by the name of “MC_backup_(model name).dat” in the route of the USB flash drive.

In case of “Restore”:

- Check that the file is stored in the route of the USB flash drive.

NOTE

- “Restore” is effective after backing up all the settings.
- Do not turn off the unit during the backing up and restoring process. Otherwise, the settings may not be restored correctly.
- The user information (such as account, password) is not saved.
- You can also backup all the settings in “Backup/Restore” in the “Setup” menu.

Related links

“Basic operation of the Front Display menu” (p.339)

Updating the firmware

Updates the firmware that provides additional features or product improvements.

New firmware can be downloaded from our website. For details, refer to the information supplied with updates.

Front Display menu

“Settings” > “Firmware Update”

Choices

Network Update	Updates the firmware via the network.
USB Update	Updates the firmware using a USB flash drive.

NOTE

- When firmware update is in preparation, “---” appears in “Network Update” and you cannot update the firmware. After a latest firmware update is available, select “Execute” and update the firmware.
- Do not perform this menu unless firmware update is necessary. Also, make sure you confirm the information supplied with updates before updating the firmware.
- You can also update the firmware in “Firmware Update” in the “Setup” menu.

Related links

- “Firmware updates” (p.354)
- “Basic operation of the Front Display menu” (p.339)

Setting the use of Retail Demo Mode

Selects whether to use Retail Demo Mode of the front display. In Retail Demo Mode, the feature of the unit and QR code are displayed on the front display. When you scan the QR code with your smartphone, you can read the introduction page of the unit.

Front Display menu

“Settings” > “Retail Demo Mode”

Settings

Off	Disables Retail Demo Mode.
On	Enables Retail Demo Mode.

NOTE

- In Retail Demo Mode, you cannot confirm information other than demonstrations on the front display. Information, such as the current input name, the current volume and other status information, is not displayed on the front display.
- However, in Retail Demo Mode, short messages are displayed.
- In Retail Demo Mode, the setting of “Auto Power Standby” in the “Setup” menu is disabled. Even if “Auto Power Standby” is set to besides “Off”, the unit does not enter to the standby mode automatically.

Related links

“Basic operation of the Front Display menu” (p.339)

UPDATE

Updating the unit's firmware

Firmware updates

New firmware that provides additional features or product improvements will be released as needed. For details on firmware, visit the Yamaha website. The unit's firmware can be updated via the network or using a USB flash drive.

■ When the unit is connected to the Internet

If a firmware update is ready, the firmware update indicator on the front display lights up.



Indicator

NOTE

- The firmware update indicator might not light up when a latest firmware update is available.
- If the Internet connection speed is slow, or the unit is connected to the wireless network, you might not get the message of new firmware depending on the condition of the network connection. In this case, update the firmware using the USB flash drive.

Related links

- “Updating the unit's firmware via the network” (p.355)
- “Updating the unit's firmware using a USB flash drive” (p.357)

Updating the unit's firmware via the network

When the unit is connected to the Internet and a firmware update is ready, the following message appears after SETUP is pressed.



Confirm the message and start the firmware update via the network.

NOTICE

- Do not operate the unit or disconnect the power cable or network cable during firmware update. If the firmware update is interrupted, there is a possibility that the unit will malfunction. In this case, contact your nearest authorized Yamaha dealer or service center to request repair.

1 Read the on-screen description.

2 Select “START”.

The on-screen display turns off and the firmware update begins.

3 When “UPDATE SUCCESS PLEASE POWER OFF!” appears on the front display, press on the front panel.

The firmware update is complete.

NOTE

- Firmware update takes about 20 minutes or more.
- If the Internet connection speed is slow, or the unit is connected to the wireless network, you might not get the message of new firmware depending on the condition of the network connection. In this case, update the firmware using the USB flash drive.

■ Firmware update reservation

In step 2, select “LATER” for reservation to perform the firmware update when turning off the unit.

With an update reservation, the firmware update confirmation screen is displayed when you turn off the unit.

Press ENTER on the front panel or on the remote control to start the firmware update. After the firmware update is complete, the unit will turn off automatically.

UPDATE > Updating the unit's firmware

NOTE

- The unit turns off automatically without performing the firmware update if two minutes pass after the screen to confirm the firmware update is displayed.
- To cancel the firmware update process, press RETURN on the front panel or on the remote control, and the unit will turn off.
- The unit turns off without performing the firmware update if you turn off the unit with MusicCast Controller.

Related links

"Firmware updates" (p.354)

Updating the unit's firmware using a USB flash drive

If the unit is not connected to the Internet, or the Internet connection speed is slow, update the firmware using the USB flash drive.

For details on downloads and firmware updates, visit the Yamaha website.

NOTICE

- Do not operate the unit or disconnect the power cable or network cable during firmware update. If the firmware update is interrupted, there is a possibility that the unit will malfunction. In this case, contact your nearest authorized Yamaha dealer or service center to request repair.

Related links

- "Updating the unit's firmware via the network" (p.355)
- "Firmware updates" (p.354)

TROUBLESHOOTING

When any problem appears

If trouble occurs, first check the following:

Make sure of the following when the unit does not function properly.

- The power cables of the unit, TV and playback devices (such as BD/DVD players) are connected to AC wall outlets securely.
- The unit, subwoofer, TV and playback devices (such as BD/DVD players) are turned on.
- The connectors of each cable are securely inserted in to jacks on each device.

Power, system, or remote control trouble

The power does not turn on

● **The protection circuitry has been activated three times consecutively.**

If the standby indicator on the unit blinks when you try to turn on the power, it means that capability to turn on the power is disabled as a safety precaution. Contact your nearest Yamaha dealer or service center to request repair.

The power does not turn on in synchronization with the TV

● **HDMI Control on the unit is disabled.**

If turning off the unit is not synchronized to the TV either, check the setting of HDMI Control on the unit. For details on HDMI Control, see the following:

- “Setting the use of HDMI Control” (p.275)

● **HDMI Control on the TV is disabled.**

If only turning on the unit is not synchronized to the TV, check the setting on the TV. For details, refer to the instruction manual for the TV and set HDMI Control on the TV.

● **Because of a power failure, the unit's power is no longer synchronized.**

Disconnect the HDMI cables and power cables, and after five minutes, reconnect the cables of playback devices first, then the unit, and then the TV. Then, check that the power is synchronized.

The power does not turn off

- **The internal microcomputer has frozen, due to an external electric shock (such as lightning or excessive static electricity) or to a drop in the power supply voltage.**

Hold down ⏻ (power) on the front panel for more than 15 seconds to reboot the unit. If the problem persists, disconnect the power cable from the AC wall outlet and plug it again.

The power turns off (standby mode) immediately

● **The unit was turned on while a speaker cable was shorted.**

Twist the bare wires of each speaker cable firmly and reconnect to the unit and speakers. For details, see the following:

- “Connecting the speaker” (p.86)

The unit enters standby mode automatically

● **The sleep timer worked.**

Turn on the unit and start playback again.

● **The auto-standby function activated because the unit was not used for the specified time.**

To disable the auto-standby function, set “Auto Power Standby” in the “Setup” menu to “Off”. For details, see the following:

- “Setting the amount of time for the auto-standby function” (p.333)

● **The speaker impedance setting is incorrect.**

Set the speaker impedance to match your speakers. For details, see the following:

- “Setting the speaker impedance” (p.239)

● **The protection circuitry has been activated because of a short circuit.**

Twist the bare wires of each speaker cable firmly and reconnect to the unit and speakers. For details, see the following:

- “Connecting the speaker” (p.86)

● **The protection circuitry has been activated because of too high volume.**

Turn down the volume. If “ECO Mode” in the “Setup” menu is set to “On”, set it to “Off”. For details, see the following:

- “Setting the use of the eco mode” (p.334)

The unit is not reacting

- **The internal microcomputer is frozen, due to an external electric shock (such as lightning or excessive static electricity) or to a drop in the power supply voltage.**

Hold down  (power) on the front panel for more than 15 seconds to reboot the unit. If the problem persists, disconnect the power cable from the AC wall outlet and plug it again.

- **The volume operation on the front panel is disabled.**

Set “Volume Knob Lock” in the “Front Display” menu to “Off”. For details, see the following:

- “Setting the use of the volume on the front panel” (p.343)

- **The operation of SELECT/ENTER on the front panel is disabled.**

Set “Input Selector Lock” in the “Front Display” menu to “Off”. For details, see the following:

- “Setting the use of the input selector on the front panel” (p.344)

- **The operation of SCENE on the front panel is disabled.**

Set “Scene Key Lock” in the “Front Display” menu to “Off”. For details, see the following:

- “Setting the use of the scene key on the front panel” (p.345)

The unit cannot be controlled using the remote control

● **The unit is out of the operating range.**

Use the remote control within the operating range. For details, see the following:

- “Operating range of the remote control” (p.15)

● **The batteries are weak.**

Replace with new batteries.

● **The unit’s remote control sensor is exposed to direct sunlight or strong lighting.**

Adjust the lighting angle, or reposition the unit.

● **The remote control sensor on the unit is turned off.**

Turn on the remote control sensor on the unit. For details, see the following:

- “Setting the use of the remote control” (p.347)

● **The remote control IDs of the unit and the remote control are not identical.**

Change the remote control ID of the unit or the remote control. For details, see the following:

- “Selecting the remote control ID” (p.348)

● **The remote control is set to another zone operation mode.**

Set the remote control to the target zone operation mode. For details, see the following:

- “Part names and functions of the remote control” (p.34)

Cannot select the desired input source even if “INPUT” is pressed

● The function which skips some input sources is set.

Set “Input Skip” of the desired input source in the “Setup” menu to “Off”. For details, see the following:

- “Setting input sources to be skipped when operating the INPUT key” (p.315)

The device connected to the unit via HDMI cannot be controlled using the RED/GREEN/YELLOW/BLUE keys of the remote control

- **The device which is connected to the unit via HDMI does not support the operation of the RED/GREEN/YELLOW/BLUE keys.**

Use a device which supports the operation of the RED/GREEN/YELLOW/BLUE keys.

- **The settings of the RED/GREEN/YELLOW/BLUE keys of the unit's remote control have been changed.**

Set the “Color Key” settings in the “Setup” menu to “Default”. For details, see the following:

- “Setting the functions for the color keys on the remote control” (p.322)

The front display is turned off

● The brightness of the front display is set to be turned off.

Set “Dimmer” in the “Front Display” menu or “Setup” menu to bigger than “-5”. For details, see the following:

- “Adjusting the brightness of the front display” (p.323)

Audio trouble

No sound

● **Another input source is selected.**

Select an appropriate input source with the input selection keys. For details, see the following:

- “Basic procedure for playing back video and music” (p.151)

● **Signals that the unit cannot reproduce are being input.**

Some digital audio formats cannot be played back on the unit. Ensure that the signals are types that the unit is able to play back. For details on supported file formats, HDMI audio formats or compatible decoding format, see the following:

- “Supported file formats” (p.427)
- “Specifications” (p.434)

● **The power of Zone is not turned on.**

Slide the Zone switch, and then press  (receiver power) to the power of Zone turns on. For details, see the following:

- “Basic procedure in zone” (p.188)

● **The cable connecting the unit and playback device is broken.**

If there is no problem with the connection, replace with another cable.

The volume cannot be increased

● **The maximum volume is set too low.**

Use “Max Volume” in the “Setup” menu to adjust the maximum volume. For details, see the following:

- “Setting the limit value of the volume” (p.257)

● **A device connected to the output jacks of the unit is not turned on.**

Turn on all devices connected to the output jacks of the unit.

● **When you start playback on the Bluetooth device or the AirPlay device, the volume of the unit is not interlocked with the volume of each device.**

Set the volume Interlock with each device. For details, see the following:

- “Setting the use of volume control via AirPlay” (p.290)
- “Setting the use of volume control via Bluetooth” (p.296)

No sound is coming from a specific speaker

● The playback source does not contain a signal for the channel.

To check it, display information about the current audio signal on the TV. For details, see the following:

- “Checking the audio signal information” (p.242)

● The currently selected sound program/decoder does not use the speaker.

To check it, use “Test Tone” in the “Setup” menu. For details, see the following:

- “Outputting test tones” (p.240)

● Audio output of the speaker is disabled.

Perform YPAO or use “Configuration” in the “Setup” menu to change the speaker settings. For details, see the following:

- “Flow of the speaker configurations” (p.115)
- “Setting the use of a subwoofer” (p.232)
- “Setting the use of each speaker and its size” (p.227)

● The volume of the speaker is set too low.

Perform YPAO or use “Level” in the “Setup” menu to adjust the speaker volume. For details, see the following:

- “Flow of the speaker configurations” (p.115)
- “Adjusting the volume of each speaker” (p.236)

● The speaker cable connecting the unit and the speaker is broken.

Check the unit’s SPEAKERS terminals and the speaker’s terminals. If there is no problem with the connection, replace a broken speaker cable with another speaker cable.

● The speaker is malfunctioning.

To check it, replace with another speaker. If the problem persists with using another speaker, the unit may be malfunctioning.

No sound is coming from the subwoofer

● **The playback source does not contain Low Frequency Effect (LFE) or low-frequency signals.**

To check it, set “Extra Bass” in the “Option” menu to “On”, in order to output the front channel low-frequency components from the subwoofer. For details, see the following:

- “Setting the use of Extra Bass” (p.205)

● **Subwoofer output is disabled.**

Perform YPAO or set “Subwoofer” in the “Setup” menu to “Use”. For details, see the following:

- “Flow of the speaker configurations” (p.115)
- “Setting the use of a subwoofer” (p.232)

● **The volume of the subwoofer is too low.**

Adjust the volume on the subwoofer.

● **The subwoofer has been turned off by its auto-standby function.**

Disable the auto-standby function of the subwoofer or adjust its sensitivity level.

No sound from the playback device connected to the unit with HDMI

- **The TV does not support HDCP (High-bandwidth Digital Content Protection).**
Refer to the instruction manuals for the TV and check the TV's specifications.
- **The number of devices connected to the HDMI OUT jack exceeds the limit.**
Disconnect some of the HDMI devices.
- **“HDMI Audio Output” in the “Setup” menu is set to “Off”.**
Set the appropriate HDMI audio output to “On”. For details, see the following:
 - “Setting the output of HDMI audio to the TV's speakers” (p.278)

No sound from the playback device when HDMI Control is used

- **The TV is set to output audio from the TV speakers.**

Change the audio output setting on your TV so that the playback device audio is output from the speakers connected to the unit.

- **TV audio is selected as the input source.**

Select an appropriate input source with the input selection keys.

No sound from the TV when HDMI Control is used

● **The TV is set to output audio from the TV speakers.**

Change the audio output setting on your TV so that the TV audio is output from the speakers connected to the unit.

● **A TV that does not support eARC/ARC is connected to the unit only with an HDMI cable.**

Use a digital optical cable to make an audio connection. For details, see the following:

- “HDMI connection with a TV” (p.89)

● **If the TV is connected to the unit with an audio cable, the TV audio input setting does not match the actual connection.**

Use “TV Audio Input” in the “Setup” menu to select the correct audio input jack. For details, see the following:

- “Setting the audio input jack used for TV audio” (p.314)

● **If you are trying to use eARC/ARC, eARC/ARC function is disabled on the unit or TV.**

Set “ARC” in the “Setup” menu to “On”, and enable eARC/ARC function on the TV. For details, see the following:

- “Setting the use of ARC” (p.276)

● **If you are trying to use eARC/ARC, the HDMI cable is not connected to the eARC/ARC-compatible HDMI jack on the TV.**

Connect the HDMI cable to the eARC/ARC-compatible HDMI jack (HDMI jack marked “ARC”) on the TV. Some HDMI jacks on the TV are not compatible with eARC/ARC. For details, refer to the instruction manual for the TV.

Any other device's audio is played back when you switch the input source of the unit to “TV”

- **The eARC/ARC function is not used.**

Audio is played back with the audio input jack selected in “TV Audio Input” in the “Setup” menu unless the TV audio is played back with eARC/ARC function. It is not a malfunction.

Only the front speakers work on multichannel audio

● The currently selected sound program is “2ch Stereo”.

Select the sound program other than “2ch Stereo”. For details, see the following:

- “Enjoying sound field effects optimized for the type of content” (p.134)

Noise/hum is heard

- **The unit is too close to another digital or radio frequency device.**

Move the unit further away from the device.

- **The cable connecting the unit and playback device is broken.**

If there is no problem with the connection, replace with another cable.

The sound is distorted

- **A device (such as an external power amplifier) connected to the unit's audio output jacks is not turned on.**

Turn on all devices connected to the unit's audio output jacks.

- **The volume of the unit is too high.**

Turn down the volume. If "ECO Mode" in the "Setup" menu is set to "On", set it to "Off". For details, see the following:

- "Setting the use of the eco mode" (p.334)

Video trouble

No video

● **Another input source is selected on the unit.**

Select an appropriate input source with the input selection keys.

● **Another input source is selected on the TV.**

Switch the TV input to display the video from the unit.

● **The video signal output from the unit is not supported by the TV.**

Check the video output setting of the playback device. For information about video signals supported by the TV, refer to the instruction manuals for the TV.

● **The cable connecting the unit and TV (or playback device) is broken.**

If there is no problem with the connection, replace with another cable.

● **An incorrect HDMI OUT jack is selected on the unit.**

Press HDMI OUT on the remote control to select the HDMI OUT jack to be used for signal output. For details, see the following:

- “Selecting an HDMI output jack” (p.152)

No video from the playback device connected to the unit with HDMI

- **The input video signal (resolution) is not supported by the unit.**

To check the information about the current video signal (resolution) and video signals supported by the unit, see the following:

- “Checking the HDMI signal information” (p.270)

- **The TV does not support HDCP (High-bandwidth Digital Content Protection).**

Refer to the instruction manuals for the TV and check the TV’s specifications.

- **The number of devices connected to the HDMI OUT jack is over the limit.**

Disconnect some of the HDMI devices.

- **The HDMI 4K/8K signal format setting is incorrect.**

Set the following to “8K Mode” to input/output 8K video content. The setting is necessary to each HDMI input jack.

- “Setting the HDMI 4K/8K signal format” (p.282)

No image (contents required the HDCP 1.4/2.3 - compatible HDMI device) from the playback device

- **The TV (HDMI input jack) does not support HDCP 1.4/2.3.**

Connect the unit to the TV (HDMI input jack) that supports HDCP 1.4/2.3. (The Warning message can be displayed on the TV screen.)

The “Option” menu or “Setup” menu is not displayed on the TV

- **Another input source is selected on the TV.**

Switch the TV input to display the video from the unit (HDMI OUT jack).

- **The Pure Direct is enabled.**

Press PURE DIRECT to disable the Pure Direct. For details, see the following:

- “Enjoying higher quality playback (Pure Direct)” (p.142)

The video is interrupted

- **If you are using two TVs in the Main zone, another TV is turned off when “HDMI OUT 1 2” is selected.**

Select “HDMI OUT 1” or “HDMI OUT 2” to output the signals only to the TV you are using. For details on selecting HDMI output, see the following:

- “Selecting an HDMI output jack” (p.152)

FM/AM radio trouble

FM radio reception is weak or noisy

- **There is multi-path interference.**

Adjust the FM antenna height or orientation, or place it in a different location.

- **Your area is too far from the FM station transmitter.**

Press MODE on the remote control to select monaural FM radio reception.

AM radio reception is weak or noisy

- **The noises may be caused by fluorescent lamps, motors, thermostats, or other electrical equipment.**

It is difficult to completely eliminate noise. It may be reduced by using an outdoor AM antenna.

Radio stations cannot be selected automatically

● **Your area is too far from the FM station transmitter.**

Select the station manually. Or use an outdoor antenna. We recommend using a sensitive multi-element antenna. For details on selecting the station manually, see the following:

- “Listening to the radio” (p.160)

● **The AM radio signal is weak.**

Adjust the AM antenna orientation. Select the station manually. Use an outdoor AM antenna. For details on selecting the station manually, see the following:

- “Listening to the radio” (p.160)

AM radio stations cannot be registered as presets

● **Auto Preset has been used.**

Auto Preset is for registering FM radio stations only. Register AM radio stations manually. For details, see the following:

- “Registering a radio station manually” (p.163)

Radio stations cannot be selected by pressing PRESET

● No radio stations are registered.

When no radio stations are registered, “No Presets” appears on the front display by pressing PRESET. Register the radio station to the preset number. For details, see the following:

- “Registering a radio station manually” (p.163)

You can also register FM radio stations with strong signals automatically (Auto Preset). For details, see the following:

- “Registering FM radio stations automatically (Auto Preset)” (p.164)

FM radio stations with weak signals might not be registered automatically. Register the stations manually.

DAB radio trouble

No DAB radio reception

● **An initial scan has not been performed.**

Perform an initial scan to receive DAB radio. For details, see the following:

- “Preparing the DAB tuning” (p.158)

No DAB radio reception even after performing an initial scan

● Reception strength of DAB radio is poor.

Check reception strength in Tune AID displayed on the front panel, and adjust the antenna height or orientation, or place it in a different location. For details, see the following:

- “Preparing the DAB tuning” (p.158)

● There is no DAB coverage in your area.

Check with your dealer or WorldDMB online at “<http://www.worlddab.org>” for a listing of the DAB coverage in your area.

DAB radio reception is weak or noisy

● **There is multi-path interference.**

Check reception strength in Tune AID displayed on the front panel, and adjust the antenna height or orientation, or place it in a different location. For details, see the following:

- “Preparing the DAB tuning” (p.158)

● **Your area is too far from the DAB station transmitter.**

Use an outdoor antenna. We recommend using a sensitive multi-element antenna.

DAB information is not available or is inaccurate

- **The selected DAB radio station may be temporarily out of service or may not provide information.**
Contact the DAB broadcaster.

No DAB radio sound

- **The selected DAB radio station may be temporarily out of service.**

Try the station later or select another station.

USB trouble

The unit does not detect the USB flash drive

- **The USB flash drive is not connected to the USB jack securely.**
Turn off the unit, reconnect your USB flash drive, and turn the unit on again.
- **The file system of the USB flash drive is not FAT16 or FAT32.**
Use a USB flash drive with FAT16 or FAT32 format.

Folders and files in the USB flash drive cannot be viewed.

- **The data in the USB flash drive is protected by the encryption.**

Use a USB flash drive without an encryption function.

The registered content in the USB flash drive cannot be recalled by pressing PRESET

- **A USB flash drive different from registration is connected to the unit.**

Connect the USB flash drive which contains the registered content as shortcut to the unit.

- **The registered content (file) has been moved to another location.**

Register the content again.

- **Some music files have been added or deleted to or from the folder.**

The unit may not recall the registered content correctly. Register the content again.

The unit does not perform continuous playback on files of USB flash drive

- **When the unit detects a series of unsupported files during playback, playback stops automatically.**

Do not save unsupported files (such as images and hidden files) in folders for playback.

- **Over 500 music files are in the selected folder.**

The maximum limits of playback are 500 music files. The folder structure of your USB flash drive may reduce the maximum limits.

Network trouble

The network feature does not function

● **The network parameters (IP address) have not been obtained properly.**

Enable the DHCP server function on your router and set “DHCP” in the “Setup” menu to “On” on the unit. For details, see the following:

- “Setting the network parameters automatically (DHCP)” (p.286)

If you want to configure the network parameters manually, check that you are using an IP address which is not used by other network devices in your network. For details, see the following:

- “Setting the network parameters manually” (p.287)

● **The unit is connected to the IPv6 router.**

Some network features of the unit do not support IPv6 network. Connect to an IPv4 network.

The unit cannot connect to the Internet via a wireless router (access point)

- **The wireless router (access point) is turned off.**

Turn on the wireless router.

- **The unit and the wireless router (access point) are too far apart.**

Place the unit and the wireless router (access point) closer to each other.

- **There is an obstacle between the unit and the wireless router (access point).**

Move the unit and the wireless router (access point) in a location where there are no obstacles between them.

- **The wireless router (access point) is set to use the wireless channel 14.**

Change settings of the wireless router (access point) to use one of the wireless channels from 1 to 13.

Wireless network is not found

- **Microwave ovens or other wireless devices in your neighborhood might disturb the wireless communication.**

Turn off these devices or move the unit and the wireless router (access point) away from them. If your wireless router supports 5 GHz band, establish a new connection in 5 GHz band.

- **Access to the network is restricted by the firewall settings of the wireless router (access point).**

Check the firewall setting of the wireless router (access point).

The unit does not detect the media server (PC/NAS)

- **The media sharing setting is not correct.**

Configure the sharing setting and select the unit as a device to which music contents are shared.

- **Some security software installed on your media server is blocking the access of the unit to your media server.**

Check the settings of security software installed on your media server.

- **The unit and media server are not in the same network.**

Check the network connections and your router settings, and then connect the unit and the media server to the same network.

The files in the media server (PC/NAS) cannot be viewed or played back

● **The files are not supported by the unit or the media server.**

Use the file format supported by both the unit and the media server. For information about the file formats supported by the unit, see the following:

- “Supported file formats” (p.427)

The registered content in the media server (PC/NAS) cannot be recalled by pressing PRESET

- **The media server (PC/NAS) is turned off.**

Turn on the media server which contains the registered content.

- **The media server (PC/NAS) is not connected to the network.**

Check the network connections and your router settings.

- **The registered content (file) has been moved to another location.**

Register the content again.

- **Some music files have been added or deleted to or from the folder.**

The unit may not recall the registered content correctly.

Register the content again.

The Internet radio cannot be played

● The unit is not connected to the Internet.

To use an Internet radio station, the unit must be connected to the Internet. Check whether the network parameters (such as the IP address) are properly assigned to the unit. For details, see the following:

- “Checking the network information of the unit” (p.284)

● The selected Internet radio station is currently not available.

There may be a network problem at the radio station, or the service may have been stopped. Try the station later or select another station.

● The selected Internet radio station is currently broadcasting silence.

Some Internet radio stations broadcast silence at certain of times of the day. Try the station later or select another station.

● Access to the network is restricted by the firewall settings of your network devices (such as the router).

Check the firewall settings of your network devices. The Internet radio can be played only when it passes through the port designated by each radio station. The port number varies depending on the radio station.

The iPhone does not recognize the unit when using AirPlay

- **The unit is connected to a multiple SSID router.**

Access to the unit might be restricted by the network separation function on the router. Connect the iPhone to the SSID which can access the unit. (Connect it to the Primary SSID at the top of the list.)

Unable to play back music with AirPlay

- **The unit cannot play back the songs stored on the iPhone.**

Check the song data. If it cannot be played on the iPhone itself, the song data or storage area may be broken.

The application for mobile devices does not detect the unit

- **The unit and mobile device are not in the same network.**

Check the network connections and your router settings, and then connect the unit and mobile device to the same network.

- **The unit is connected to a multiple SSID router.**

Access to the unit might be restricted by the network separation function on the router. Connect the mobile device to the SSID which can access the unit. (Connect it to the Primary SSID at the top of the list.)

Firmware update via the network is failed

● **It may not be possible depending on the condition of the network.**

Update the firmware via the network again or use a USB flash drive. For details, see the following:

- “Updating the firmware” (p.338)

Bluetooth® trouble

A Bluetooth® connection cannot be established

● **The wireless antennas on the rear panel of the unit does not stand upright.**

Stand the wireless antennas upright for connecting to a Bluetooth device wirelessly.

● **The Bluetooth function of the unit is disabled.**

Enable the Bluetooth function. For details, see the following:

- “Setting the use of Bluetooth®” (p.293)

● **The Bluetooth function of a Bluetooth device is turned off.**

Turn on the Bluetooth function of a Bluetooth device.

● **Another Bluetooth device is already connected to the unit.**

Terminate the current Bluetooth connection and then establish a new connection. For details, see the following:

- “Playback of Bluetooth® device music on the unit” (p.166)

● **The unit and the Bluetooth device are too far apart.**

Move the Bluetooth device closer to the unit.

● **There is a device (such as microwave oven and wireless LAN) that outputs signals in the 2.4 GHz frequency band nearby.**

Move the unit and the Bluetooth device away from those devices. If your wireless router supports 5 GHz band, establish a new connection in 5 GHz band.

● **The Bluetooth device does not support A2DP.**

Use a Bluetooth device that supports A2DP.

● **The connection information registered on the Bluetooth device is not working for some reason.**

Delete the connection information on the Bluetooth device, and then establish a connection between the Bluetooth device and the unit again. For details, see the following:

- “Playback of Bluetooth® device music on the unit” (p.166)

No sound is produced, or the sound is interrupted during playback with Bluetooth® connection

- **The volume of the Bluetooth device is set too low.**

Turn up the volume of the Bluetooth device.

- **The Bluetooth device is not set to send audio signals to the unit.**

Switch the audio output of the Bluetooth device to the unit.

- **The Bluetooth connection has been terminated.**

Establish a Bluetooth connection between the Bluetooth device and the unit again. For details, see the following:

- “Playback of Bluetooth® device music on the unit” (p.166)

- **The unit and the Bluetooth device are too far apart.**

Move the Bluetooth device closer to the unit.

- **There is a device (such as microwave oven and wireless LAN) that outputs signals in the 2.4 GHz frequency band nearby.**

Move the unit and the Bluetooth device away from those devices. If your wireless router supports 5 GHz band, establish a new connection in 5 GHz band.

Error indications on the front display

Error indications on the front display

Refer to the following table when the error message is indicated on the front display.

Message	Cause	Remedy
Check SP Wires	The speaker cables are short circuited.	Twist the bare wires of the cables firmly and connect to the unit and speakers properly. For details, see the following: <ul style="list-style-type: none"> • “Connecting the speaker” (p.86)
Access denied	Access to the media servers (PCs/NAS) is denied.	Configure the sharing settings and select the unit as a device to which music contents are shared.
Access error	The unit cannot access the USB device.	Turn off the unit and reconnect your USB device. If the problem persists, try another USB device.
	There is a problem with the signal path from the network to the unit.	Make sure your router and modem are turned on, and check the connection between the unit and your router (or hub). For details, see the following: <ul style="list-style-type: none"> • “Connecting a network cable (wired connection)” (p.102) • “Preparing wireless antennas (wireless connection)” (p.103)
Unable to play	The unit cannot play back the songs.	Ensure that the files are types that the unit is able to play back. If the unit supports the file format, but still cannot play back any files, the network may be overloaded with heavy traffic. For information about the formats supported by the unit, see the following: <ul style="list-style-type: none"> • “Supported file formats” (p.427)
USB Overloaded	An overcurrent is flowing through the USB device.	Turn off the unit and reconnect your USB device. If the problem persists, try another USB device.
Internal Error	An internal error has occurred.	Contact the nearest authorized Yamaha dealer or service center.
Remote ID Mismatch	The remote control IDs of the unit and the remote control are not identical.	Change the remote control ID of the unit or the remote control. For details, see the following: <ul style="list-style-type: none"> • “Selecting the remote control ID” (p.348)
Remote Sensor Off	The remote control sensor on the unit is turned off.	Turn on the remote control sensor on the unit. For details, see the following: <ul style="list-style-type: none"> • “Setting the use of the remote control” (p.347)
NOT FOUND	In “USB Update”, the firmware file stored on the USB flash drive was not found.	Check that the new firmware is stored on the USB flash drive. For details on downloads, visit the Yamaha website.
Version error	Firmware update failed.	Update the firmware again. For details, see the following: <ul style="list-style-type: none"> • “Updating the firmware” (p.352) • “Updating the unit’s firmware via the network” (p.355)
Update failed.	Firmware update failed.	According to the guidance displayed on the front display, update the firmware again.

APPENDIX

Care and cleaning

Care for the front panel

The way of care for the front panel is as follows.

- Wipe the front panel with a soft dry cloth. Do not wipe the surface hard.
Failure to observe this may cause damage to the surface.
- Before you clean the front panel, be sure to turn off (standby) the power to the unit.
- In standby mode, hold down SELECT/ENTER to disable the touch panel operation so that you can prevent the unit from turning on carelessly.

Connecting to a network wirelessly

Selecting a wireless network connection method

Select a wireless connection method according to your network environment.

- 1 Press SETUP.**
- 2 Select “Network”.**
- 3 Select “Network Connection”.**
- 4 Select “Wireless(Wi-Fi)”.**

The following connection methods are available.

- “Setting up a wireless connection using the WPS button” (p.415)
- “Setting up a wireless connection using an iPhone” (p.416)
- “Setting up a wireless connection by selecting from the list of available access points” (p.417)
- “Setting up a wireless connection manually” (p.418)
- “Setting up a wireless connection using the WPS PIN code” (p.419)

NOTE

When the unit is added to a MusicCast network, the network settings can be configured at the same time. If you use MusicCast, this method is recommended.

Related links

“Adding the unit to the MusicCast network” (p.112)

Setting up a wireless connection using the WPS button

You can easily set up a wireless connection with one push of the WPS button on the wireless router.

Setup menu

“Network” > “Network Connection” > “Wireless(Wi-Fi)”

- 1 Select “WPS Button”.**
- 2 According to the on-screen guidance, connect to the network wirelessly.**

When the connection process finishes, “Completed” appears on the TV.

If “Not connected” appears, repeat from step 1 or try another connection method.

This completes the network settings.

NOTE

The unit may not connect to the wireless router using WEP as the encryption method. In this case, try another connection method.

About WPS

- WPS (Wi-Fi Protected Setup) is a standard established by the Wi-Fi Alliance, which allows easy establishment of a wireless home network.

Related links

“Selecting a wireless network connection method” (p.414)

Setting up a wireless connection using an iPhone

You can set up a wireless connection by applying the connection settings on iPhone.

Before proceeding, confirm that your iPhone is connected to a wireless router.

NOTE

You need iPhone with iOS 7 or later.

Setup menu

“Network” > “Network Connection” > “Wireless(Wi-Fi)”

1 Select “WAC(iOS)”.

2 According to the on-screen guidance, connect to the network wirelessly.

When the sharing process finishes, the unit is automatically connected to the selected network.

This completes the network settings.

NOTE

- This process will restore the default settings for the following.
 - Network settings
 - Bluetooth settings
 - Bluetooth, USB, media server and network content registered as shortcuts
 - Internet radio stations registered to “Favorites”
 - Account information for the network services
- This configuration does not work if the security method of your wireless router (access point) is WEP. In this case, use other connection method.
- If the unit is connected with a network cable, a warning message is displayed on the TV. Disconnect the network cable from the unit, and then set up a wireless connection.

Related links

“Selecting a wireless network connection method” (p.414)

Setting up a wireless connection by selecting from the list of available access points

You can set up a wireless connection by selecting an access point from the list of wireless LAN routers found by the unit. You need to manually enter the security key.

Setup menu

“Network” > “Network Connection” > “Wireless(Wi-Fi)”

- 1 Select “Access Point Scan”.**
- 2 According to the on-screen guidance, connect to the network wirelessly.**

When the connection process finishes, “Completed” appears on the TV.

If “Not connected” appears, repeat from step 1 or try another connection method.

This completes the network settings.

Related links

“Selecting a wireless network connection method” (p.414)

Setting up a wireless connection manually

You can set up a wireless connection by entering the required information manually. You need to set up the SSID (network name), encryption method and security key for your network.

Setup menu

“Network” > “Network Connection” > “Wireless(Wi-Fi)”

1 Select “Manual Setting”.

2 According to the on-screen guidance, connect to the network wirelessly.

When the connection process finishes, “Completed” appears on the TV.

If “Not connected” appears, check that all the information is entered correctly, and repeat from step 1.

This completes the network settings.

Related links

“Selecting a wireless network connection method” (p.414)

Setting up a wireless connection using the WPS PIN code

You can set up a wireless connection by entering the unit's PIN code into the wireless router. The method is available if the wireless router supports the WPS PIN code method.

Setup menu

"Network" > "Network Connection" > "Wireless(Wi-Fi)"

1 Select "PIN Code".

2 According to the on-screen guidance, connect to the network wirelessly.

When the connection process finishes, "Completed" appears on the TV.

If "Not connected" appears, repeat from step 1 or try another connection method.

This completes the network settings.

Related links

"Selecting a wireless network connection method" (p.414)

Using presence speakers

Presence speaker layout

The following three layout patterns are available for the presence speakers. Choose a layout pattern that suits your listening environment.

- Front Height/Rear Height
- Overhead
- Dolby Enabled SP

NOTE

- You can enjoy Dolby Atmos, DTS:X, AURO-3D or CINEMA DSP HD³ with any layout pattern.
- When using presence speakers, configure the “Layout” setting of the front presence and rear presence speakers in the “Setup” menu before automatically optimizing the speaker settings (YPAO).

Related links

- “Setting the layout of the front presence speakers” (p.229)
- “Setting the layout of the rear presence speakers” (p.230)

Installing the presence speakers in Front Height/Rear Height position

Install the presence speakers on the front/rear wall (Front Height/Rear Height).

It delivers a natural sound field with excellent linkage of left, right, top and bottom sound spaces, and sound extensity effectively.



Installing the presence speakers in Overhead position

Install the presence speakers to the ceiling above the listening position (Overhead).

It delivers realistic overhead sound effects and sound field with excellent linkage of front and rear sound spaces effectively.



CAUTION

- Be sure to use speakers that are made for ceiling use and take anti-drop measures. Ask a qualified contractor or dealer personnel for installation works.



NOTE

- When installing 2 presence speakers to a ceiling, install them just above the listening position, or the ceiling between the extensions of the front speakers and listening position.

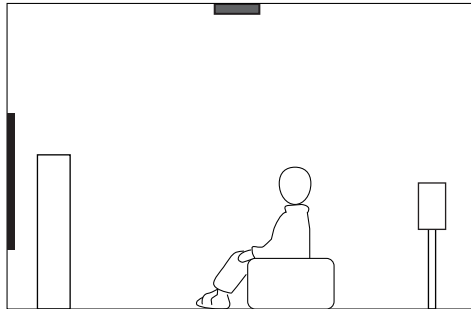
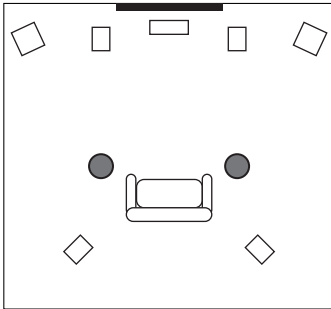

- When installing 4 presence speakers to a ceiling, install 2 front presence speakers to the ceiling between the extensions of the front speakers and listening position, and install 2 rear presence speakers to the ceiling between the extensions of the listening position and surround (or surround back) speakers.

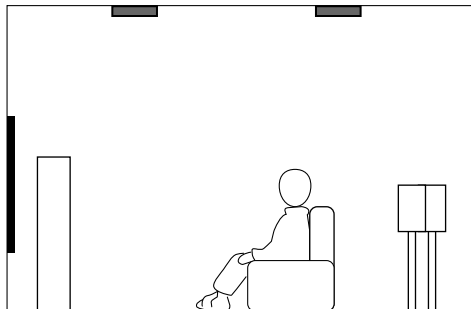
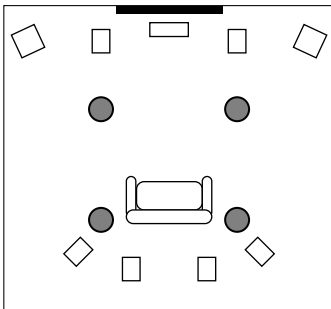

Using Dolby Enabled speakers as the presence speakers

Use Dolby Enabled speakers as the presence speakers.

This utilizes sound reflected from ceiling and lets you enjoy overhead sound only from speakers that are placed at the same level as traditional speakers.

For details, refer to the instruction manual for the Dolby Enabled speakers.



NOTE

- Place the Dolby Enabled speakers on top of or near the traditional front, surround or surround back speakers.
- A Dolby Enabled speaker unit may be integrated into a traditional speaker.

Supported devices and file formats

Supported Bluetooth® devices

The following Bluetooth devices can be used by the unit.

- Bluetooth devices that support A2DP can be used.
- Operation of all Bluetooth devices cannot be guaranteed.

Supported USB devices

The following USB devices can be used by the unit.

- This unit is compatible with USB memory devices that are in FAT16 or FAT32 format.
Do not connect any other type of USB devices.
- USB devices with encryption cannot be used.
- Operation of all USB devices cannot be guaranteed.

Supported file formats

The following file formats can be used by the unit.

File	Sampling frequency (kHz)	Quantization bits (bit)	Bitrate (kbps)	Number of channels	Support for gapless playback
WAV *	32/44.1/48/ 88.2/96/176.4/ 192/352.8/384	16/24/32	-	2	○
MP3	32/44.1/48	-	8 to 320	2	-
WMA	32/44.1/48	-	8 to 320	2	-
MPEG-4 AAC	32/44.1/48	-	8 to 320	2	-
FLAC	32/44.1/48/ 88.2/96/176.4/ 192/352.8/384	16/24	-	2	○
ALAC	32/44.1/48/ 88.2/96	16/24	-	2	○
AIFF	32/44.1/48/ 88.2/96/176.4/ 192/352.8/384	16/24/32	-	2	○
DSD	2.8 MHz/ 5.6 MHz/ 11.2 MHz	1	-	2	○

* Linear PCM format only. 32 bit-float files cannot be played back.

- The playable file formats differ depending on the software installed on media servers (PCs/NAS). Refer to the instruction manual of the server software for details.
- Digital Rights Management (DRM) contents cannot be played back.

Zone output

Multi-zone output

Multi-zone output is shown as follows.

Input	Output					
	Using the unit's internal amplifier		Using an external amplifier			
	EXTRA SP 1-2 jacks		ZONE OUT jacks		HDMI OUT 3 (ZONE OUT) jack (*4)	
	Zone2	Zone3	Zone2	Zone3	Zone2	Zone4
Digital audio (HDMI)	→ (*2)		→ (*2)		→ (*5)	→ (*6, *7)
Digital audio (COAXIAL/OPTICAL)	→ (*3)	→ (*3)	→ (*3)	→ (*3)	→ (*3)	
Analog audio (AUDIO)	→	→	→	→	→	
USB (*1)	→	→	→	→	→	
Network sources (*1)	→	→	→	→	→	
TUNER	→	→	→	→	→	

→ : Available

- *1 To play back DSD audio in Zone2 or Zone3, select “Main Zone Sync” as the Zone2 or Zone3 input, or use the party mode.
- *2 It is available when PCM signals (2 channels) are input. Stereo output (mixed down to 2 channels) is available when the multichannel signals are input. DSD audio is available only when the input source selected in the Main zone is selected.
- *3 It is available when PCM signals (2 channels) are input.
- *4 Set “HDMI ZONE OUT Assign” in the “Setup” menu to “Zone2” or “Zone4”.
- *5 It is available when PCM signals (2 channels) are input. Stereo output (mixed down to 2 channels) is available when the multichannel signals are input.
- *6 HDMI audio signals are pass-through.
- *7 When the input source selected in the Main zone is also selected in Zone4, audio output of the Main zone is limited to the formats that the device connected to Zone4 supports.

NOTE

During the party mode, the input source selected in the Main zone is played back in all zones.

Related links

- “Connecting zone speakers using the unit's internal amplifier” (p.184)
- “Connecting zone speakers using an external amplifier” (p.185)
- “Enjoying the same source in multiple rooms (party mode)” (p.190)
- “Setting the zone assignment of the HDMI out jack” (p.279)

Video signal flow

Video signal flow

Video signals input from a video device to the unit are output to a TV as follows.

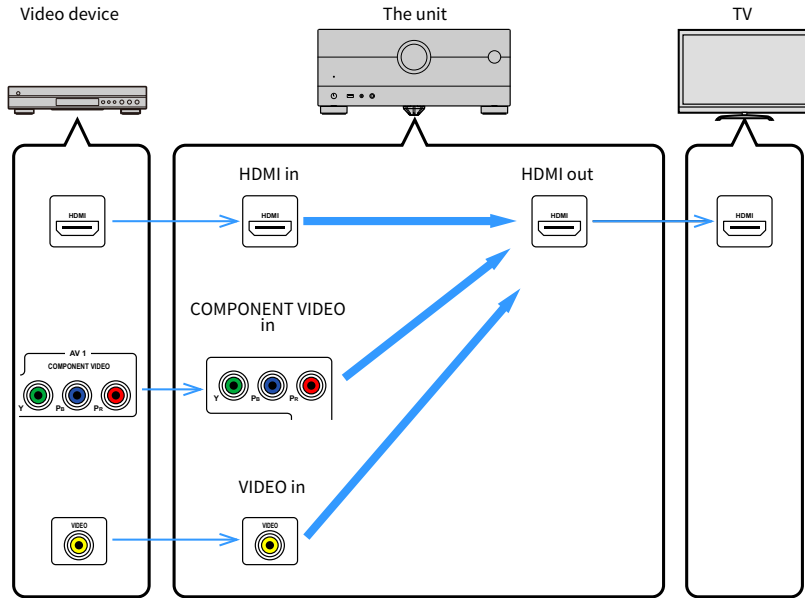

Video conversion table

Video conversion table is shown as follows.

	Resolution	HDMI out							
		480i/ 576i	480p/ 576p	720p	1080i	1080p	4K	8K* ¹	8K* ²
HDMI in	480i/576i	→	→	→	→	→	→		→
	480p/576p		→	→	→	→	→		→
	720p			→	→	→	→		→
	1080i			→	→	→	→		→
	1080p/50, 60 Hz			→	→	→	→		→
	1080p/24 Hz					→	→		→
	4K						→		→
	8K*¹							→	
	8K*²							→	
COMPONENT VIDEO in	480i/576i	→	→	→	→	→	→		→
	480p/576p		→	→	→	→	→		→
	720p			→	→	→	→		→
	1080i			→	→	→	→		→
VIDEO in	480i/576i	→	→	→	→	→	→		→

→ : Available

*1 It is available in case of compressed video signals by DSC (Display Stream Compression), that is a video compression technique standardized by VESA.

*2 It is available in case of non-compressed video signals.

NOTE

- You can select the resolution and the aspect ratio applied to HDMI-output video processing in “Video Mode” in the “Setup” menu.
- When “HDMI ZONE OUT Assign” in the “Setup” menu is set to “Zone2” for which the HDMI OUT 3 (ZONE OUT) jack is used, conversion from 1080p to 4K/8K, or from 4K to 8K is only available. All other resolutions are pass-through.

Related links

- “Setting a resolution to output HDMI video signals” (p.272)
- “Setting the zone assignment of the HDMI out jack” (p.279)

Trademarks

Trademarks

The trademarks used in this manual are as follows.

COMPATIBLE WITH



Dolby, Dolby Vision, Dolby Atmos, and the double-D symbol are trademarks of Dolby Laboratories Licensing Corporation.

Manufactured under license from Dolby Laboratories. Confidential unpublished works.

Copyright © 2012–2021 Dolby Laboratories. All rights reserved.



For DTS patents, see <http://patents.dts.com>.

Manufactured under license from DTS, Inc. or under license from DTS Licensing Limited.

DTS, DTS:X, and the DTS:X logo are registered trademarks or trademarks of DTS, Inc. in the United States and other countries.

© 2020 DTS, Inc. ALL RIGHTS RESERVED.



Manufactured under license from Auro Technologies.

AURO, AURO-3D, Auro-Codec and Auro-Matic are registered trademarks of Auro Technologies.



This AV Receiver is compatible with AirPlay 2. iOS 11.4 or later is required.

Use of the Works with Apple badge means that an accessory has been designed to work specifically with the technology identified in the badge and has been certified by the developer to meet Apple performance standards.

Apple, AirPlay, Apple TV, Apple Watch, iPad, iPad Air, iPad Pro, iPhone, Lightning, and iTunes are trademarks of Apple Inc., registered in the U.S. and other countries.

Amazon Alexa™

Amazon, Alexa, Amazon Music and all related logos are trademarks of Amazon.com, Inc. or its affiliates.

App Store

App Store is a service mark of Apple Inc., registered in the U.S. and other countries.



The terms HDMI, HDMI High-Definition Multimedia Interface, HDMI Trade Dress and the HDMI Logos are trademarks or registered trademarks of HDMI Licensing Administrator, Inc.

x.v.Color™

“x.v.Color” is a trademark of Sony Corporation.

Android Google Play

Android and Google Play are trademarks of Google LLC.



The Wi-Fi CERTIFIED™ Logo and Wi-Fi Protected Setup Logo are registered trademark of Wi-Fi Alliance®.

Wi-Fi, Wi-Fi CERTIFIED, Wi-Fi Protected Setup and WPA2 are trademarks or registered trademarks of Wi-Fi Alliance®.



The Bluetooth® word mark and logos are registered trademarks owned by Bluetooth SIG, Inc. and any use of such marks by Yamaha Corporation is under license.



The unit supports DAB/DAB+ tuning.



“SILENT CINEMA” is a trademark of Yamaha Corporation.



MusicCast is a trademark or registered trademark of Yamaha Corporation.



Yamaha Eco-Label is a mark that certifies products of high environmental performance.

Google Noto Fonts

This product uses the following fonts.

Copyright © June 2015, Google (<https://www.google.com/get/noto/#sans-lgc>), with Reserved Font Name Noto Sans.

Copyright © June 2015, Google (<https://www.google.com/get/noto/help/cjk/>), with Reserved Font Name Noto Sans CJK.

This Font Software is licensed under the SIL Open Font License, Version 1.1.

This license is available with a FAQ at: <http://scripts.sil.org/OFL>

GPL/LGPL

This product utilizes GPL/LGPL open-source software in some sections. You have the right to obtain, duplicate, modify, and redistribute this open-source code only. For information on GPL/LGPL open source software, how to obtain it, and the GPL/LGPL license, refer to the Yamaha Corporation website

(<https://download.yamaha.com/sourcecodes/musiccast/>).

Licenses

For information on the licenses of the third-party software in this product, refer to the following.

[http://\(IP address of this product*\)/licenses.html](http://(IP address of this product*)/licenses.html)

* IP address of this product is checked with MusicCast Controller.

Specifications

Specifications

The specifications of this unit are as follows.

Input jacks

Analog Audio

- Audio (Unbalance) x 6 (including PHONO)
- Audio (Balance) x 1

Digital Audio

- Optical x 3 (Supported frequencies: 32 kHz/44.1 kHz/48 kHz/88.2 kHz/96 kHz)
- Coaxial x 2 (Supported frequencies: 32 kHz/44.1 kHz/48 kHz/88.2 kHz/96 kHz/176.4 kHz/192 kHz)

HDMI Input

- HDMI x 7

Other jacks

- USB x 1 (USB2.0)
- NETWORK (Wired) x 1 (100Base-TX/10Base-T)

Output jacks

Analog Audio

- Speaker Out x 11 (9 ch) (FRONT L/R, CENTER, SURROUND L/R, SURROUND BACK L/R, EXTRA SP 1 L/R^{*1}, EXTRA SP 2 L/R^{*2})

*1 Assignment is possible [F.PRESENCE, ZONE2, ZONE3]

*2 Assignment is possible [R.PRESENCE, ZONE2, ZONE3, BI-AMP (FRONT L/R)]

- Pre Out x 15 (FRONT L/R, FRONT (Balance) L/R, CENTER, SURROUND L/R, SURROUND BACK L/R, F.PRESENCE L/R, R.PRESENCE L/R, SUBWOOFER 1/2)
- ZONE OUT x 4 (ZONE2 L/R, ZONE3 L/R)
- Headphone x 1

HDMI Output

- HDMI OUT x 3*
 - * HDMI OUT 3 is a jack dedicated to zone out.

Other jacks

- YPAO MIC x 1
- REMOTE IN x 1
- REMOTE OUT x 1
- TRIGGER OUT x 2

HDMI

HDMI Features:

- 8K/4K Ultra HD Video (include 4K/120 Hz, 8K/60 Hz), 3D Video, ARC (Audio Return Channel), eARC (enhanced Audio Return Channel), HDMI Control (CEC), Auto Lip Sync, Deep Color, "x.v.Color", HD audio playback, 21:9 Aspect Ratio, BT.2020 Colorimetry, HDR Compatible, HDR10+ Compatible, Dolby Vision, Hybrid Log-Gamma, ALLM (Auto Low Latency Mode), VRR (Variable Refresh Rate), Dedicated HDMI Zone Output

Video Format (Repeater Mode)

- VGA
- 480i/60 Hz
- 576i/50 Hz
- 480p/60 Hz
- 576p/50 Hz
- 720p/60 Hz, 50 Hz
- 1080i/60 Hz, 50 Hz
- 1080p/120 Hz, 100 Hz, 60 Hz, 50 Hz, 30 Hz, 25 Hz, 24 Hz
- 4K/120 Hz, 100 Hz, 60 Hz, 50 Hz, 30 Hz, 25 Hz, 24 Hz
- 8K/60 Hz, 50 Hz, 30 Hz, 25 Hz, 24 Hz

Audio Format

- Dolby Atmos
- Dolby TrueHD
- Dolby Digital Plus
- Dolby Digital
- DTS:X
- DTS-HD Master Audio
- DTS-HD High Resolution
- DTS Express
- DTS
- DSD 2-ch to 6-ch (2.8 MHz)
- PCM 2-ch to 8-ch (Max. 192 kHz/24-bit)

Content Protection: HDCP 1.4/2.3 compatible

Link Function: CEC supported

TUNER

Analog Tuner

- [U.K., Europe and Russia models]
DAB/FM with Radio Data System x 1 (TUNER)
- [Australia model]
DAB/FM x 1 (TUNER)
- [Other models]
FM/AM x 1 (TUNER)

USB

Capable of Mass Storage Class USB Memory

Current Supply Capacity: 1.0 A

Bluetooth

Sink Function

- Source Device to AVR (ex. Smartphone/Tablet)
- Supported profile
 - A2DP, AVRCP
- Supported codec
 - SBC, AAC

Source Function

- AVR to Sink Device (ex. Bluetooth Headphone)
- Supported profile
 - A2DP, AVRCP
- Supported codec
 - SBC
- Capable of Play/Stop Operation from Sink Device

Bluetooth version

- Ver. 4.2

Wireless output

- Bluetooth Class 2

Maximum communication distance

- 10 m (33 ft) without interference

Network

PC Client Function

AirPlay 2 supported

Internet Radio

music streaming service

Wi-Fi function

- Capable of WPS by PIN Method and Push-Button-Method
- Available Security Method: WEP, WPA2-PSK (AES), Mixed Mode, None
- Wireless LAN Standards: IEEE 802.11 a/b/g/n/ac*
 - * 20 MHz channel bandwidth only

Compatible Decoding Formats

Decoding Format

- Dolby Atmos
- Dolby TrueHD, Dolby Digital Plus
- Dolby Digital
- DTS:X
- DTS-HD Master Audio, DTS-HD High Resolution, DTS Express
- DTS, DTS 96/24, DTS-ES Matrix 6.1, DTS-ES Discrete 6.1

Post Decoding Format

- Dolby Surround
- Neural:X
- AURO-3D

Audio Section

Rated Power Output (2-channel driven)

- (20 Hz to 20 kHz, 0.06% THD, 8 Ω)
 - Front L/R, Surround L/R, Surround Back L/R, Front Presence L/R 150 W/ch
 - Center 150 W
- (1 kHz, 0.9% THD, 8 Ω)
 - Front L/R, Surround L/R, Surround Back L/R, Front Presence L/R 165 W/ch
 - Center 165 W

Power Output (1-channel driven)

- (1 kHz, 0.9% THD, 8 Ω)
 - Front L/R, Center, Surround L/R, Surround Back L/R, Front Presence L/R 185 W
- (1 kHz, 0.9% THD, 6 Ω)
 - Front L/R, Center, Surround L/R, Surround Back L/R, Front Presence L/R 200 W
- (1 kHz, 0.9% THD, 4 Ω)
 - Front L/R 230 W

Maximum Effective Power Output (1-channel driven)

- (1 kHz, 10% THD, 8 Ω)
 - Front L/R, Center, Surround L/R, Surround Back L/R, Front Presence L/R 220 W
- (1 kHz, 10% THD, 6 Ω)
 - Front L/R, Center, Surround L/R, Surround Back L/R, Front Presence L/R 250 W

Damping Factor

- Front L/R (1 kHz, 8 Ω) 120 or more

APPENDIX > Specifications

Input Sensitivity / Input Impedance	
• PHONO (1 kHz, Rated Power Output)	4.5 mV/47 k Ω
• AUDIO 2 etc. (Unbalance) (1 kHz, Rated Power Output)	250 mV/47 k Ω
• AUDIO 4 (Balance) (1 kHz, Rated Power Output)	
• Attenuator Off	260 mV/200 k Ω
• Attenuator On	520 mV/200 k Ω
Maximum Input Signal	
• PHONO (1 kHz, 0.5% THD)	45 mV
• AUDIO 2 etc. (Unbalance) (1 kHz, 0.5% THD)	2.4 V
• AUDIO 4 (Balance) (1 kHz, 0.5% THD)	
• Attenuator Off	2.4 V
• Attenuator On	4.8 V
Rated Output Level/Output Impedance	
• PRE OUT	
• Front L/R, Center, Surround L/R, Surround Back L/R, Front Presence L/R, Rear Presence L/R (1 kHz)	1.0 V/470 Ω
• Subwoofer 1/2 (50 Hz)	1.0 V/470 Ω
• Front (Balance) L/R	2.0 V/470 Ω
• ZONE2/3 OUT	470 mV/470 Ω
Maximum Output Level	
• PRE OUT	
• Front L/R, Center, Surround L/R, Surround Back L/R, Front Presence L/R, Rear Presence L/R	2.0 V
• Subwoofer 1/2	6.5 V
• Front (Balance) L/R	4.0 V
Headphone Impedance	
	16 Ω or more
Frequency Response	
• AUDIO 2 etc. to Front (Pure Direct) (10 Hz to 100 kHz)	+0/-3 dB
RIAA Equalization Deviation	
• PHONO (20 Hz to 20 kHz)	0 \pm 0.5 dB
Total Harmonic Distortion	
• PHONO to PRE OUT (Pure Direct) (1 kHz, 1 V)	0.04% or less
• AUDIO 2 etc. to Front (Pure Direct) (20 Hz to 20 kHz, 75 W, 8 Ω)	0.05% or less
Signal to Noise Ratio (IHF-A Network)	
• PHONO (Pure Direct) (Input 1 k Ω Shorted, Speaker Out)	95 dB or more
• AUDIO 2 etc. (Pure Direct) (Input 1 k Ω Shorted, Speaker Out)	110 dB or more

APPENDIX > Specifications

Residual Noise (IHF-A Network)	
• Front L/R (Speaker Out)	150 μ V or less

Channel Separation	
• PHONO (Input 1 k Ω Shorted, 1 kHz/10 kHz)	75 dB/60 dB or more
• AUDIO 2 etc. (Input 1 k Ω Shorted, 1 kHz/10 kHz)	75 dB/61 dB or more

Volume Control	
• Main Zone	MUTE, -80 dB to +16.5 dB (0.5 dB Step)
• Zone2 (Speaker Out)	MUTE, -80 dB to +16.5 dB (0.5 dB Step)
• Zone2 (PRE OUT)	MUTE, -80 dB to +10.0* dB (0.5 dB Step)
• Zone3 (Speaker Out)	MUTE, -80 dB to +16.5 dB (0.5 dB Step)
• Zone3 (PRE OUT)	MUTE, -80 dB to +10.0* dB (0.5 dB Step)

* This is the maximum value on the condition: digital input, Tone Control Bypass, Compressed Music Enhancer Off. It does not go up to the maximum under the other conditions.

Tone Control Characteristics	
• Main Zone	
• Bass Boost/Cut	\pm 6 dB/0.5 dB Step at 50 Hz
• Bass Turnover	350 Hz
• Treble Boost/Cut	\pm 6 dB/0.5 dB Step at 20 kHz
• Treble Turnover	3.5 kHz
• Zone2/3	
• Bass Boost/Cut	\pm 6 dB/0.5 dB Step at 50 Hz
• Bass Turnover	350 Hz
• Treble Boost/Cut	\pm 6 dB/0.5 dB Step at 20 kHz
• Treble Turnover	3.5 kHz

Filter Characteristics	
(fc=40/60/80/90/100/110/120/160/200 Hz)	
• H.P.F. (Front, Center, Surround, Surround Back)	12 dB/oct.
• L.P.F. (Subwoofer)	24 dB/oct.

Video Section

Video Signal Type	NTSC/PAL/SECAM
-------------------	----------------

Video Signal Level	
• Composite	1 Vp-p/75 Ω
• Component	
• Y	1 Vp-p/75 Ω
• Pb/Pr	0.7 Vp-p/75 Ω

 Video Maximum Input Level

1.5 Vp-p

FM Section

Tuning Range

- [U.S.A. and Canada models] 87.5 MHz to 107.9 MHz
- [Asia, Taiwan, Brazil, Central and South America and General models] 87.5/87.50 MHz to 108.0/108.00 MHz
- [Other models] 87.50 MHz to 108.00 MHz

50 dB Quiet Sensitivity (IHF, 1 kHz, 100% MOD.)

- Monaural 3 μ V (20.8 dBf)

Signal to Noise Ratio (IHF)

- Monaural 69 dB
- Stereo 68 dB

Harmonic Distortion

- Monaural 0.5%
- Stereo 0.6%

Antenna Input

75 Ω unbalanced

AM Section (Except for U.K., Europe, Russia and Australia models)

Tuning Range

- [U.S.A. and Canada models] 530 kHz to 1710 kHz
- [Asia, Taiwan, Brazil, Central and South America and General models] 530/531 kHz to 1710/1611 kHz
- [Other models] 531 kHz to 1611 kHz

DAB Section (U.K., Europe, Russia and Australia models)

Tuning Range

174.928 MHz to 239.200 MHz (Band III)

Support Audio Format

MPEG 1 Layer II/MPEG-4 HE-AAC v2 (aacPlus v2)

Antenna

75 Ω unbalanced

General

Power Supply	
• [U.S.A. and Canada models]	AC 120 V, 60 Hz
• [Taiwan, Brazil and Central and South America models]	AC 110 to 120 V, 60 Hz
• [China model]	AC 220 V, 50 Hz
• [Korea model]	AC 220 V, 60 Hz
• [Australia model]	AC 230 to 240 V, 50 Hz
• [U.K., Europe and Russia models]	AC 230 V, 50 Hz
• [Asia and General models]	AC 220 to 240 V, 50/60 Hz
Power Consumption	
	500 W
Standby Power Consumption*	
• HDMI Control Off, Standby through Off, Network Standby Off	0.4 W
• HDMI Control On, Standby through On, Network Standby Off	
• Input: AV1 (HDMI no signal)	1.9 W
• HDMI Control Off, Standby through Off, Network Standby On, Bluetooth Standby Off	
• Wired	1.7 W
• Wi-Fi	1.8 W
• HDMI Control Off, Standby through Off, Network Standby On, Bluetooth Standby On	
• Wired	1.7 W
• Wi-Fi	3.0 W
* The unit in standby mode may download the new firmware via the network. In this case, the standby power consumption is increased than the shown value.	
Maximum Power Consumption (All ch driven 10% THD)	
• [Asia, Brazil, Central and South America and General models]	1160 W
Dimensions (W x H x D)	
	435 x 192 x 442 mm (17-1/8" x 7-1/2" x 17-3/8")
Reference Dimensions (with wireless antenna upright)	
	435 x 271 x 442 mm (17-1/8" x 10-5/8" x 17-3/8")
Weight	
• [U.K., Europe, Russia, Australia and China models]	20.3 kg (44.8 lbs)
• [Other models]	18.7 kg (41.2 lbs)

* The contents of this manual apply to the latest specifications as of the publishing date. To obtain the latest manual, access the Yamaha website then download the manual file.

Default settings

Default settings of the Option menu

The default settings of the “Option” menu are as follows.

Tone Control	Treble, Bass Bypass (0.0 dB)
	* When both “Treble” and “Bass” are 0.0 dB, “Bypass” appears.
YPAO Volume	
• YPAO Volume	Off
• Adaptive DRC	Off
Dialogue	
• Dialogue Level	0
• DTS Dialogue Control	0
• Dialogue Lift	0
Lipsync	0 ms
Enhancer	
• Enhancer	
• HDMI 1-7, AUDIO 1-4, AV 1-3, PHONO, TV	Off
• Others	On
• Hi-Res Mode	On
Volume Trim	
• Input Trim	0.0 dB
• Subwoofer Trim	0.0 dB
Extra Bass	Off
Video Processing	
• Video Mode	Direct
• Video Adjustment	1
Video Out	Off
Shuffle / Repeat	
• Shuffle	Off
• Repeat	Off

Default settings of the Setup menu

The default settings of the “Setup” menu are as follows.

Speaker

Setting Pattern	Pattern1
Setting Data Copy	-
Power Amp Assign	Basic
Configuration	
• Front	Small
• Center	Small
• Surround	Small
• Layout	Rear
• Surround Back	Small
• Front Presence	Small
• Layout	Front Height
• Rear Presence	Small
• Layout	Rear Height
• Crossover	80 Hz
• Subwoofer	Use
• Phase	Normal
• Layout	Monaural x2
Distance	3.00 m (10.0 ft)
Level	0.0 dB
Parametric EQ	Through
Speaker Impedance	8Ω MIN
Test Tone	Off
YPAO Result	
• Result	-

Sound

Information	-
-------------	---

APPENDIX > Default settings

Lipsync	
• Delay Enable	Enable
• Auto/Manual Select	Auto
• Adjustment	0 ms

DSP Parameter	-
---------------	---

Surround Decoder	
• AURO-3D	
• AURO-3D Listening Mode	AURO-3D
• Auro-Matic Preset	Medium
• Auro-Matic Strength	12

All-Channel Stereo	
• Level	0
• Front / Rear Balance	0
• Left / Right Balance	0
• Height Balance	5
• Monaural Mix	Off

Dynamic Range	Maximum
---------------	---------

Volume	
• Max Volume	+16.5 dB
• Initial Volume	Off

Pure Direct Mode	Auto
------------------	------

Adaptive DSP Level	On
--------------------	----

Virtual Speaker	
• VPS	On
• VSBS	On
• Dolby Speaker Virtualization	On

Ultra Low Jitter PLL Mode	Level 1
---------------------------	---------

DAC Digital Filter	Short Latency Type
--------------------	--------------------

Balance Input Attenuator	Bypass
--------------------------	--------

DTS Mode	Mode 1
----------	--------

Scene

Scene Setting	-
---------------	---

Scene Rename	-
Video/HDMI	
Information	-
Video Mode	
• Video Mode	Direct
• Resolution	Auto
• Aspect	Through
• Adjustment	-
HDMI Control	
• HDMI Control	On
• ARC	On
• Standby Sync	Auto
HDMI Audio Output	
• HDMI OUT1	Off
• HDMI OUT2	Off
• HDMI ZONE OUT	Off
HDMI ZONE OUT Assign	Zone2
HDCP Version	
• HDMI 1-7	Auto
HDMI Standby Through	
• U.K., Europe, Russia and Korea models	Auto
• Other models	On
HDMI Video Format	
• HDMI 1-7	4K Mode 1
Network	
Information	-
Network Connection	Wired
IP Address	
• DHCP	On
Network Standby	Auto
DMC Control	Enable

APPENDIX > Default settings

AirPlay Volume Interlock	Limited
Network Name	-
MusicCast Link Power Interlock	Off

Bluetooth

Bluetooth	On
Audio Receive	
• Disconnect	-
• Bluetooth Standby	On
• Bluetooth Volume Interlock	Limited
Audio Send	
• Transmitter	Off
• Device Search	-

Multi Zone

Information	-
Zone2/Zone3	
• Volume	Variable
• Max Volume	+16.5 dB
• Initial Volume	Off
• Audio Delay	0 ms
• Monaural	Off
• Enhancer	On
• Tone Control	Auto
• Extra Bass	Off
• Left / Right Balance	0
Zone Rename	
• Main Zone	-
• Zone2/3/4	-
Party Mode Set	
• Target : Zone2/3/4	Enable

System

Information	-
-------------	---

APPENDIX > Default settings

Language	English
Audio In	-
TV Audio Input	AUDIO 1
Input Skip	Off
Input Rename	
• HDMI 1-7	Auto
• Others	Manual
Auto Play	On
	(Default setting may be different depending on the input source.)
DSP Skip	Off
Tuner	FM50/AM9 (Asia, Taiwan, Brazil, General, and Central and South America models only)
Remote Key	
• PROGRAM Key	Assign1
• Color Key	Default
Display Settings	
• Dimmer	-2
• Volume	dB
• Short Message	On
• Position	Bottom
• Wallpaper	Type 1
Touch Sound	On
Trigger Output 1/2	
• Trigger Mode	Power
• Target Zone	All
ECO	
• Auto Power Standby	20 minutes
• ECO Mode	Off
Memory Guard	Off
Initialization	-

APPENDIX > Default settings

Backup/Restore

-

Firmware Update

-

Default settings of the Front Display menu

The default settings of the “Front Display” menu are as follows.

Dimmer	-2
Zone Power	Off
Settings	
• Function Lock	
• Volume Knob Lock	Off
• Input Selector Lock	Off
• Scene Key Lock	Off
• Touch Sound	On
• Remote Sensor	On
• Remote ID	ID1
• Information Skip	Off
• Initialization	-
• Backup/Restore	-
• Firmware Update	-
• Retail Demo Mode	Off

Yamaha Global Site
<https://www.yamaha.com/>

Yamaha Downloads
<https://download.yamaha.com/>

© 2021 Yamaha Corporation

Published 04/2024 NV-G0

AV19-0085