



YAMAHA

MULTITRACK CASSETTE RECORDER

MT400

Owner's Manual

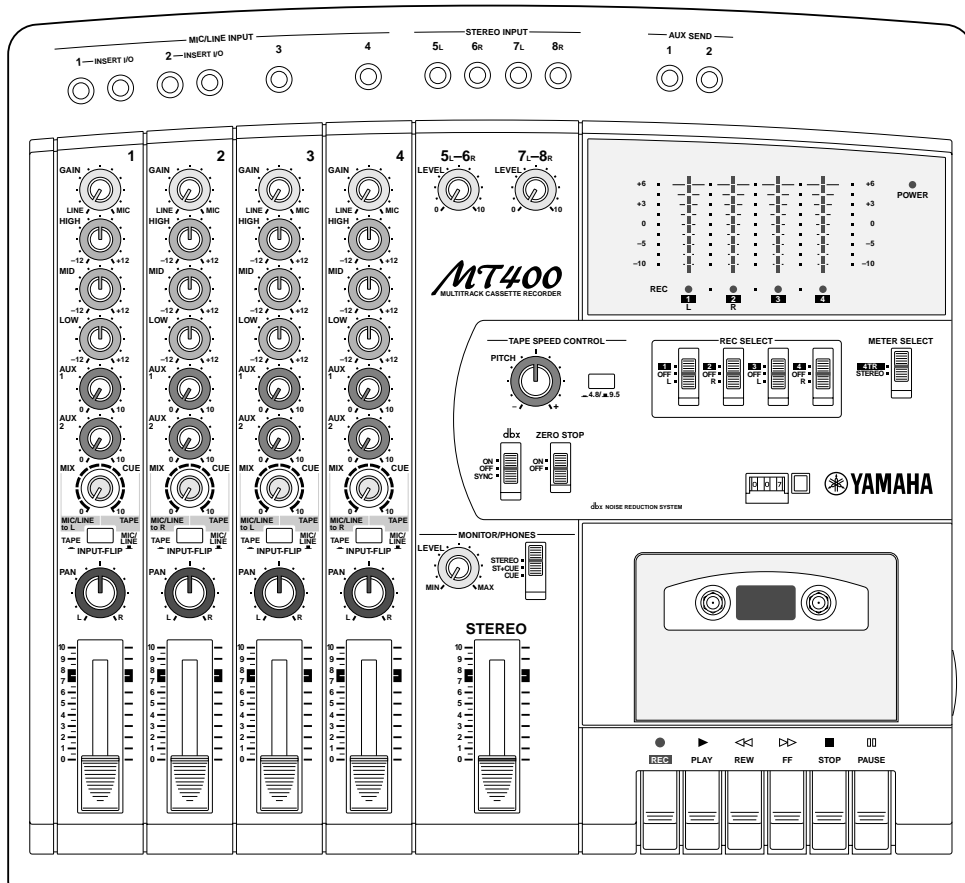

Important

Read the Following Before Operating MT400

Warnings

- Do not locate MT400 in a place subject to excessive heat or in direct sunlight. This could be a fire hazard.
- Do not place MT400 in a place subject to excessive humidity or dust. This could be a fire and electrical shock hazard.
- Do not place heavy objects on the power cord. A damaged power cord is a potential fire and electrical shock hazard.
- Do not place small metal objects on top of MT400. Metal objects inside MT400 are a fire and electrical shock hazard.
- Do not try to modify MT400. This could be a fire and electrical shock hazard.

Cautions

- Turn off all audio devices and speakers when connecting to MT400. Refer to the owner's manual for each device. Use the correct cables and connect as specified.
- MT400 is a precision device. Handle it with care.
- If you notice any abnormality—such as smoke, odor, or noise—turn off MT400 immediately. Remove the AC adapter from the AC outlet. Confirm that the abnormality is no longer present. Consult your dealer for repair. Using MT400 in this condition is a fire and shock hazard.
- If a foreign object or water gets inside MT400, turn it off immediately. Remove the AC adapter from the AC outlet. Consult your dealer for repair. Using MT400 in this condition is a fire and electrical shock hazard.
- If you plan not to use MT400 for a long period of time (such as when you are on vacation), remove the AC adapter from the AC outlet. Leaving MT400 connected is a fire hazard.
- Do not use benzene, thinner, cleaning detergent, or a chemical cloth to clean MT400.
- Use only a soft, dry cloth to clean MT400.

Interference

MT400 uses high-frequency digital circuits that may cause interference on radios and televisions placed close to it. If interference does occur, relocate the affected equipment.

Copyright

© 1998 Yamaha Corporation. All rights reserved.

No part of the MT400 software or this Owner's Manual may be reproduced or distributed in any form or by any means without the prior written authorization of Yamaha Corporation.

Trademarks

The dbx noise reduction system is manufactured based on a patent license from THAT Corporation.

dbx is a trademark of Carillon Electronics Corporation.

All other trademarks are the property of their respective holders.

Keep This Manual For Future Reference

Contents

Welcome to the MT400.....	3	Advanced Recording Techniques	22
MT400 Features.....	3	Simultaneous Multi-Channel Recording	22
Mixer.....	3	Ping-Pong Recording	24
Recorder	3	Multi-Source Mixing.....	26
Buying Cassette Tapes for the MT400	4	Using Effects	28
MT400 Recording Format	4	Using INSERT I/O.....	28
About dbx Noise Reduction	5	Using AUX SENDs	29
Glossary.....	5	Applying Effects to Multiple Channels When Recording.....	30
Touring the MT400.....	6	Applying Effects to Only a Monitor Signal ..	32
Input Channels.....	6	Applying Effects at Mixdown.....	33
Stereo Inputs	8	Punch In/Out Recording.....	34
Monitor/Master Section	8	Using the REC SELECT switch.....	34
Recorder Section	9	Using a Footswitch	35
Transport Section.....	10	MIDI Synchronization	37
Meter Section	11	Synchronizing the MT400 with a MIDI Se- quencer.....	37
Input/Output Section	11	Connecting the MT400 to a MIDI System...	38
Front Panel	12	Recording a SYNC Signal on the Tape	40
Rear Panel.....	12	Synchronized Recording.....	41
The First Session	13	Synchronized Mixdown	43
Preparation	13	Appendix.....	44
Quick-Start System	13	Troubleshooting	44
Turning On the MT400	14	Maintaining the MT400	45
Loading a Cassette Tape	14	Cleaning the Record-Play Head, Erase Head, Capstan, and Pinch Roller.....	45
Recording the First Track	14	Demagnetizing the Record-Play Head	45
Preparation Before Recording.....	14	Specifications	46
The First Take.....	16	Dimensions	47
Overdubbing.....	18	Block Diagram	48
Mixdown.....	20		

Welcome to the MT400

MT400 Features

The MT400 consists of three major sections: a Mixer section that enables you to mix sounds (with eight inputs and one stereo output): a Recorder section that records and plays sound (with four tracks and four channels): and utility sections including meters, power switch, etc.

Mixer

- Continuously variable GAIN controls on Input Channels 1 through 4 allow the MT400 to handle any type of input source with ease, including microphone and line-level signals such as synthesizers.
- Musical three-band EQ on each input channel, and INSERT I/O jacks on Input Channels 1 and 2 for external processor patching enable high-quality recording.
- Two auxiliary sends for external reverb and other effects processor patching.
- Two stereo input jacks for connecting a synthesizer and other line-level instruments that have stereo outputs. These jacks can be also used to return processed signals from external signal processors.
- In-line configuration that allows you to control input signals and tape playback signals simultaneously. You can monitor track signals adjusted by the CUE controls, while making a recording on all four input channels. During mixdown, you can play back four-track signals via the input channels, while mixing input signals via the CUE controls.

Recorder

- dbx™ noise reduction system provides a signal-to-noise ratio in excess of 80 dB.
- Punch in/out functions using a footswitch or the switch on the panel.
- SYNC OUT outputs a sync track (Track 4) signal, providing synchronous operation between the MT400 and a MIDI sequencer. In SYNC mode, the dbx noise reduction can be turned off for Track 4, ensuring reliable synchronization.
- Tape speed is switchable between 9.5 cm/second and 4.8 cm/second. The MT400 standard tape speed is 9.5 cm/second for greater sonic performance. A speed of 4.8 cm/second is the same speed as a normal cassette recorder, doubling the recording time relative to the MT400 standard speed. Pitch control enables you to fine-adjust the pitch in the range between -10% and +10%.

Buying Cassette Tapes for the MT400

It is important that you buy the correct type of cassette tape for use with your MT400. You should buy high-quality Type II (High Bias, 70 μ s EQ) chrome cassettes of 90 minutes or less, such as TDK SA or MAXELL CDXL II.

At normal speed, a 60-minute cassette provides about 15 minutes of recording time. That is because the tape runs at twice the speed of a normal cassette recorder and you can use only one side of the tape.

The following table shows the available recording times with three standard tape sizes:

Cassette Tape	MT400 Recording Time (with the standard speed)
C90	Approx. 22.5 minutes
C60	Approx. 15 minutes
C46	Approx. 11.5 minutes

Note: We recommend that you use a brand new cassette tape for important recording. If you record on a used tape repeatedly, the recorded sound may skip or sound quality may deteriorate.

MT400 Recording Format

A normal cassette recorder uses only two tracks (i.e., left and right stereo channels) for each side (A and B). The transport direction of the A side is opposite that of the B side. The MT400 uses only one side of the cassette, and records and plays up to four tracks simultaneously or one at a time. Therefore, tapes with all four tracks recorded on the MT400 cannot be played on normal cassette players. If you try to play back a tape recorded with normal cassette recorders on the MT400, you will hear Tracks 3 and 4 play backwards.

Normal cassette recorder tracks

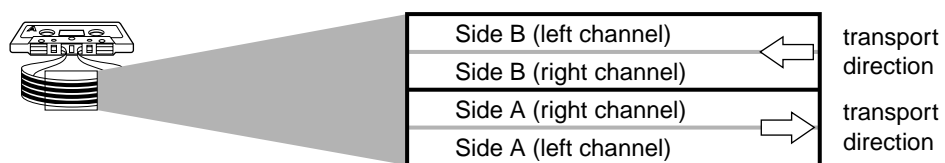

MT400 tracks



The tape speed of normal cassette recorders is 4.8 cm/second. On the other hand, the MT400 uses 9.5 cm/second as its standard speed to achieve high-quality sound.

About dbx Noise Reduction

The MT400 uses the dbx noise reduction system to reduce tape hiss and keep your recordings clean and crisp. For the best performance, it is recommended that you use the dbx noise reduction for all your recordings. You should always use the dbx noise reduction system to correctly play back tapes that were recorded with the dbx system on.

Glossary

This section describes basic terminology used in this manual.

■ Input channel

A path (channel) for audio signal between a mixer input jack and the bus (see below). Signal input at an input jack is adjusted for the volume level and tonal quality here before being sent to the bus.

■ Track

The MT400 can record four individual sound sources simultaneously on the four sections of a cassette tape. This does not mean that the tape is cut into four pieces. The tape forms four magnetic bands along the length of the tape. Each magnetic recording band is called a “track”. The MT400 can use up to four tracks (Tracks 1–4).

■ Bus

A path where multiple audio signals are mixed into one signal. The MT400 offers the following buses that can be used depending on the purpose.

Stereo L/R bus — This bus is used to create a stereo signal. Stereo bus signal is output from the STEREO OUT L/R jacks. You can record stereo L bus signal to both Track 1 and 3 of the recorder section, and stereo R bus signal to both Track 2 and 4. To monitor stereo bus signals, use the MONITOR OUT L/R jacks. You can also monitor them via headphones.

Cue bus — This bus is used to create a monaural signal for monitoring, which is output from the MONITOR OUT L/R jacks. You can also monitor the signal via headphones.

AUX 1 and 2 buses — These buses are used to send out signals to connected effects processors from the AUX SEND 1 and 2 jacks in monaural. You can monitor the signals via headphones.

■ Overdubbing

Overdubbing is a technique used to record new sounds to empty tracks while listening to the sounds already recorded on other tracks.

■ Ping-pong recording

Ping-pong recording is a technique used to free up tracks by mixing one or two existing tracks to an unused track.

■ Mixdown

Mixdown is a technique used to mix the sounds into a balanced stereo mix and record it to a stereo master recorder. It is also called “tracking down”.

Touring the MT400

This section takes you on a tour of the MT400, identifying the various parts to familiarize you with your new recorder.

Input Channels

① GAIN control

This rotary control adjusts the sensitivity of the MIC/LINE INPUT jack ⑩ so that both microphone and line-level (such as a synthesizer) signals can be handled with ease.

② EQ control

These rotary controls are used to adjust a tonal quality of the high, middle, and low frequency bands independently. They boost (amplify) and cut (attenuate) the corresponding basic frequency in the range of ± 12 dB. A flat setting (i.e., no boost or cut) can be set quickly using the control's center detentes.

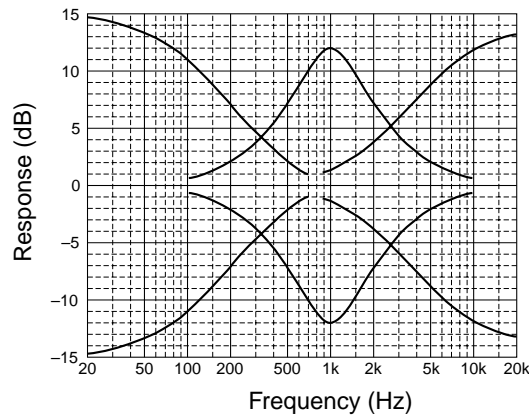

HIGH: Basic frequency 12 kHz (shelving type)

MID: Basic frequency 1 kHz (peaking type)

LOW: Basic frequency 80 Hz (shelving type)

③ AUX controls

These rotary controls are used to send the input channel (1–4) signal to the AUX SEND 1 and 2 outputs. They are commonly used to adjust the level of signal sent to external effects processors.

Note: The AUX controls handle post-fader signals (signals that have passed through the faders ⑦). If the faders are lowered all the way, the AUX control settings will not be effective.

④ CUE control

This control is used to adjust the level of Track (1–4) input signal and playback signal that will be sent to the cue bus. The CUE bus signals are output from the PHONES jack or the MONITOR OUT jack for monitoring. The CUE signal source depends on the [INPUT-FLIP] switch ⑤.

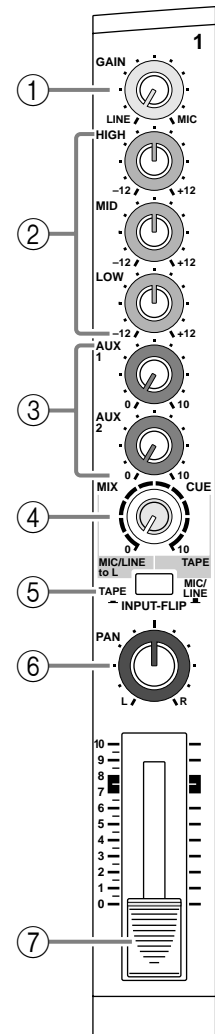

⑤ INPUT-FLIP switch

This switch is used to select the destination of the signal input from the MIC/LINE INPUT jacks and the tape signal. With the switch in the MIC/LINE position (), the MIC/LINE input signal is fed to the ST bus via the input channel and the tape signal is fed to the CUE bus.

With the switch in the TAPE position (), the MIC/LINE input 1, 3 (2, 4) signal is fed to the ST L (ST R) bus and the tape signal is fed to the ST bus via the input channel.

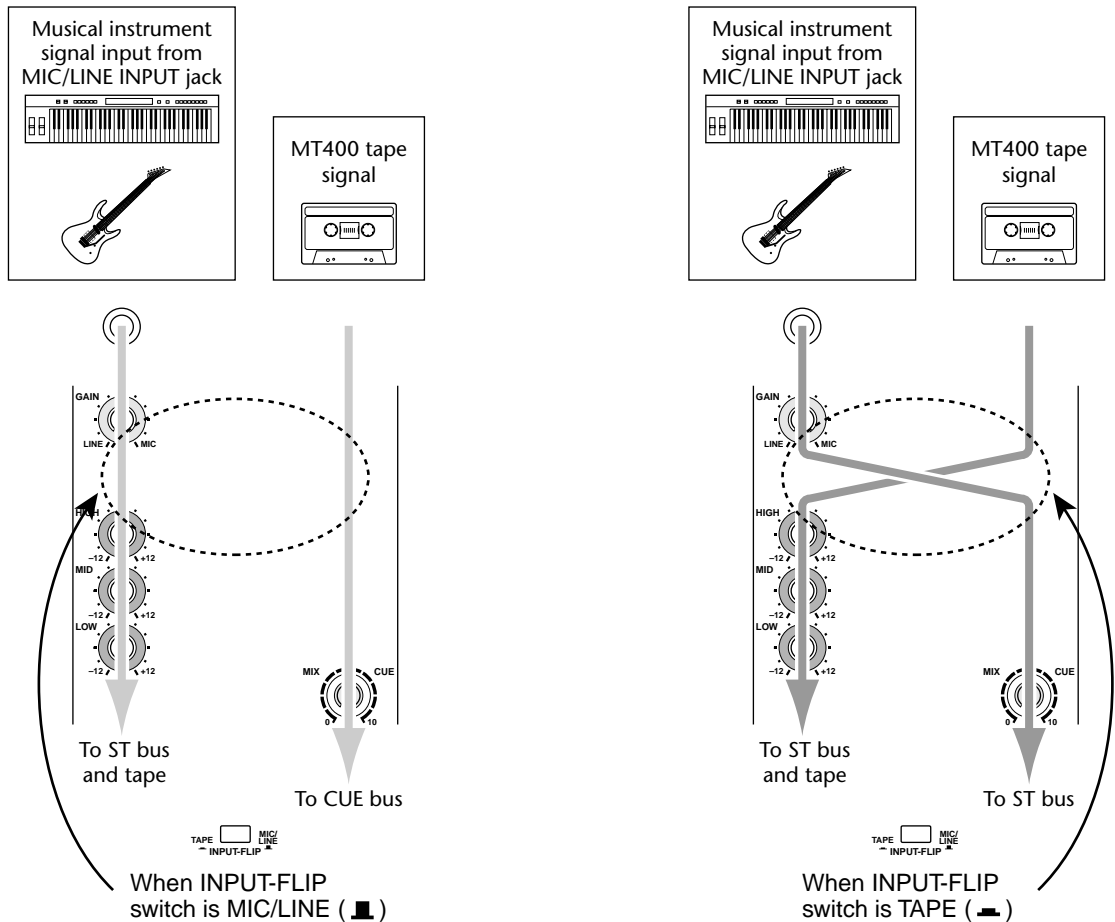

⑥ PAN control

This rotary control is used to adjust the stereo position (left or right) of input channel signal that will be sent to the Stereo bus. For recording via the Stereo bus (See page 22), turn this control all the way to the left to assign the signal to odd tracks (1, 3), and all the way to the right to assign the signal to even tracks (2, 4). For mixdown you can use it to pan the playback signal in the stereo mix.

⑦ Fader

For recording ([INPUT-FLIP] switch: MIC/LINE), use the fader to adjust the level of the input channel signal that is recorded to a track. For mixdown ([INPUT-FLIP] switch: TAPE), use it to adjust the playback level of each track. Unity gain is obtained when the fader is positioned about the 7–8 mark.

Unity gain: The condition where the output signal and input signal are at the same level, with signal-to-noise ratio and distortion set to optimum.

Stereo Inputs

⑧ LEVEL controls

These rotary controls are used to adjust the level of the stereo input signals that are input at the STEREO INPUT jacks 5 and 6 or 7 and 8. These signals are usually sent to the Stereo bus for mixing with Input Channel 1–4 signals and tape signals.

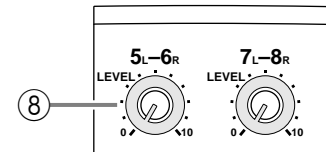

Monitor/Master Section

⑨ MONITOR LEVEL control

This rotary control adjusts the level of the monitor signal that is sent to the MONITOR OUT ③⑨ and PHONES ③④ jacks.

⑩ Monitor select switch

This switch is used to select the signal source for the MONITOR OUT ③⑨ and PHONES ③④.

STEREO ... This position selects the Stereo bus and allows you to monitor the STEREO OUT signal.

ST+CUE.... This position selects the Stereo bus and the CUE bus as the monitor source.

CUE This position selects the CUE bus as the monitor source.

⑪ STEREO fader

Use this fader to adjust the level of the stereo signal that is sent to the STEREO OUT jacks. Unity gain is obtained when the fader is positioned about the 7–8 mark.

Unity gain: See ⑦ Fader.

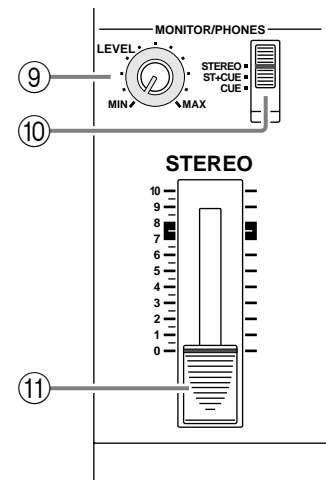

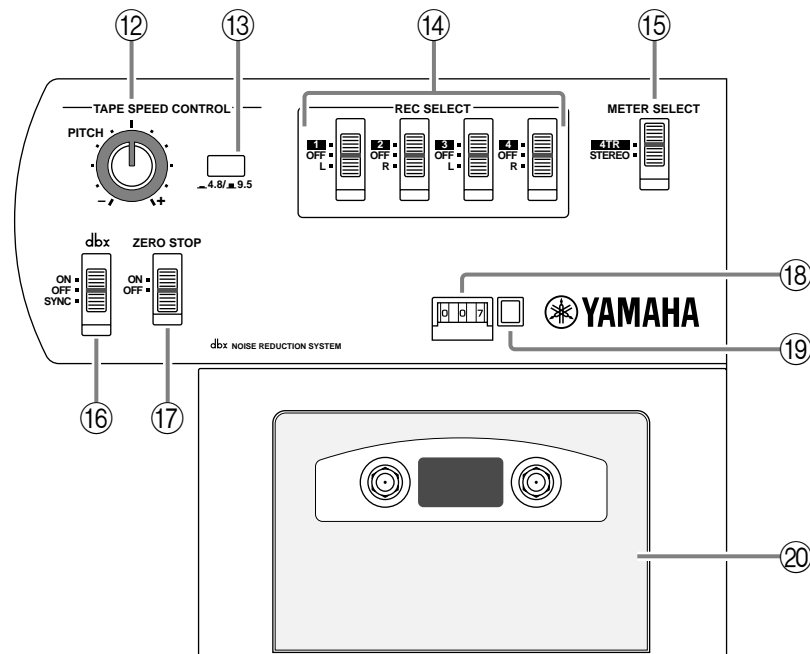

Recorder Section



⑫ PITCH control

This rotary control adjusts the tape speed in the range of $\pm 10\%$.

⑬ Tape speed switch

This switch is used to select 4.8 cm/second or 9.5 cm/second for the tape speed. Set the switch to 9.5 () for normal recording, and 4.8 () for playback of a tape recorded with a normal cassette tape recorder.

⑭ REC SELECT switches

These switches are used to select recording sources for tracks.

1 – **4** ...Input channel (1–4) signals are routed directly to the corresponding tracks for recording (direct recording).

OFFThe corresponding tracks are disabled for recording.

L/RThe corresponding tracks are ready for recording and receive L channel (Tracks 1 and 3) or R channel (Tracks 2 and 4) signals.

⑮ METER SELECT switch

This switch selects the signal level to be displayed on the level meters [27](#).

4TRThe level meters display the track input signal levels during recording and the track output signal levels during playback.

STEREOThe level meters display the Stereo bus signal levels (signal output from the STEREO OUT jacks).

⑯ dbx switch

Use this switch to turn on and off the dbx noise reduction system.

ONThe dbx noise reduction system is turned on for all tracks.

OFFThe dbx noise reduction system is turned off for all tracks.

SYNCThe dbx noise reduction system is turned off only for Track 4.

Note: The SYNC setting is used for a special application in which Track 4 is used for synchronization. See page 41 for more information.

⑰ ZERO STOP switch

Use this switch to turn on and off the Zero Stop function. With this switch set to on (ON), the tape rewind automatically stops when the tape counter returns to just before “000”.

⑱ Tape counter

This 3-digit tape counter indicates the tape position.

⑲ Counter reset button

This button resets the tape counter value to “000”.

⑳ Cassette compartment

Insert a cassette tape here.

Transport Section

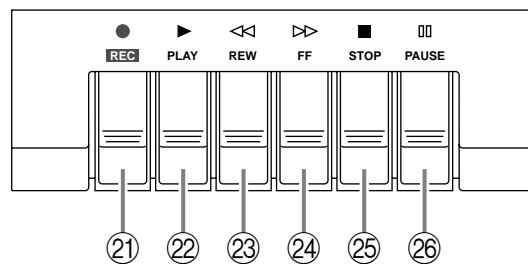
**⑳ REC button (●)**

Pressing this button turns the PLAY button ⑳ on and starts recording on the currently available tracks. When you press this button during playback, recording starts from the point you press the button. This button is disabled if a tape is not set or write-protect tabs on the tape are broken.

㉑ PLAY button (▶)

Use this button to start playback of the tracks.

㉒ REW button (◀◀)

Use this button to rewind the tape.

㉓ FF button (▶▶)

Use this button to fast forward the tape.

㉔ STOP button (■)

Use this button to stop the tape transport.

㉕ PAUSE button (⏸)

Use this button to pause recording or playback. Pressing this button to stop recording or playback and pressing it again will resume recording or playback.

Meter Section

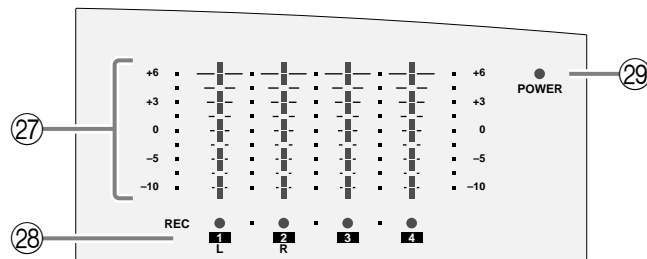

27 Level meters

These meters show the signal levels from -10 dB to $+6$ dB. When the METER SELECT switch (15) is set to “**4TR**”, they show the track signal levels during recording and playback. When the METER SELECT switch is set to “STEREO”, they show the STEREO OUT signal levels.

28 REC SELECT indicator

These indicators show which tracks are selected for recording. They flash when you select recording sources by the REC SELECT switches (14), and light up continuously when you press the **REC** button to start recording.

29 POWER indicator

This indicator lights up when you turn on the power to the unit.

Input/Output Section

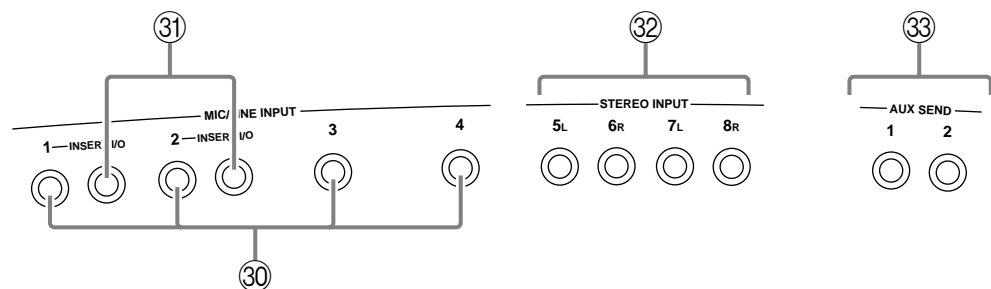

30 MIC/LINE INPUTS 1–4

Use these 1/4" TRS phone jacks to connect microphones and electronic musical instruments such as a synthesizer to the MT400.

31 INSERT I/O

Use these TRS phone jacks to output, then input channels 1 and 2 signals. Typically, signal processors, such as compressors, limiters, and noise gates are connected to these jacks. Signals output from the mixer section are processed on the effects processor and returned to the mixer via these jacks. (See page 28)

32 STEREO INPUTS

Use these 1/4" phone jacks to connect line-level sound sources that have stereo outputs, such as a synthesizer and a CD player. They can also be used to return the processed stereo signals from external effects processors, such as a reverb unit. (See page 29)

33 AUX SEND

Use these 1/4" phone jacks to output the channel signals adjusted by the AUX controls (3). You can use these as effect sends by connecting to the effects processors' inputs. (See page 29)

Front Panel

③④ PHONES

A pair of stereo headphones can be connected here for monitoring. The headphone signal is the same as the MONITOR OUT signal.

③⑤ PUNCH I/O

An optional footswitch, such as the Yamaha FC5, can be connected here for foot-controlled punch in/out.

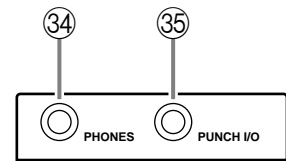

Rear Panel

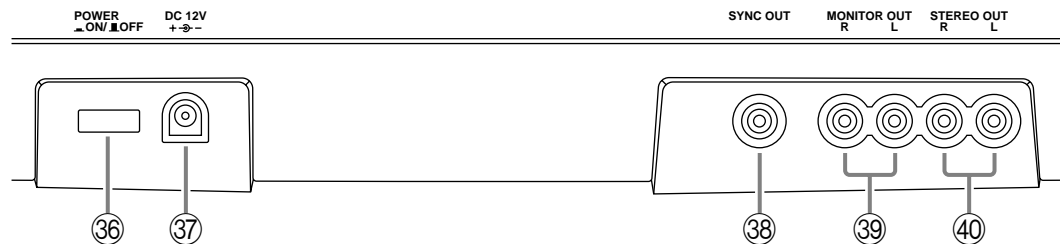

③⑥ POWER ON/OFF switch

Use this switch to turn on and off the MT400.

③⑦ DC 12V

Connect the AC adapter here.

Use a 12 V AC adapter of at least 650 mA.

③⑧ SYNC OUT

Use this phono jack to individually output FSK and SMPTE synchronization signals recorded on the sync track (Track 4).

③⑨ MONITOR OUTs

Use these phono jacks to send the monitor signals. Connect your hi-fi system or powered speakers.

③⑩ STEREO OUTs

Use these phono jacks to output Stereo bus signal adjusted by the STEREO fader. Connect them to your master recorder's stereo inputs for mixdown.

The First Session

This chapter explains how to record four tracks individually and mix your first MT400 session onto a master recorder.

Preparation

Quick-Start System

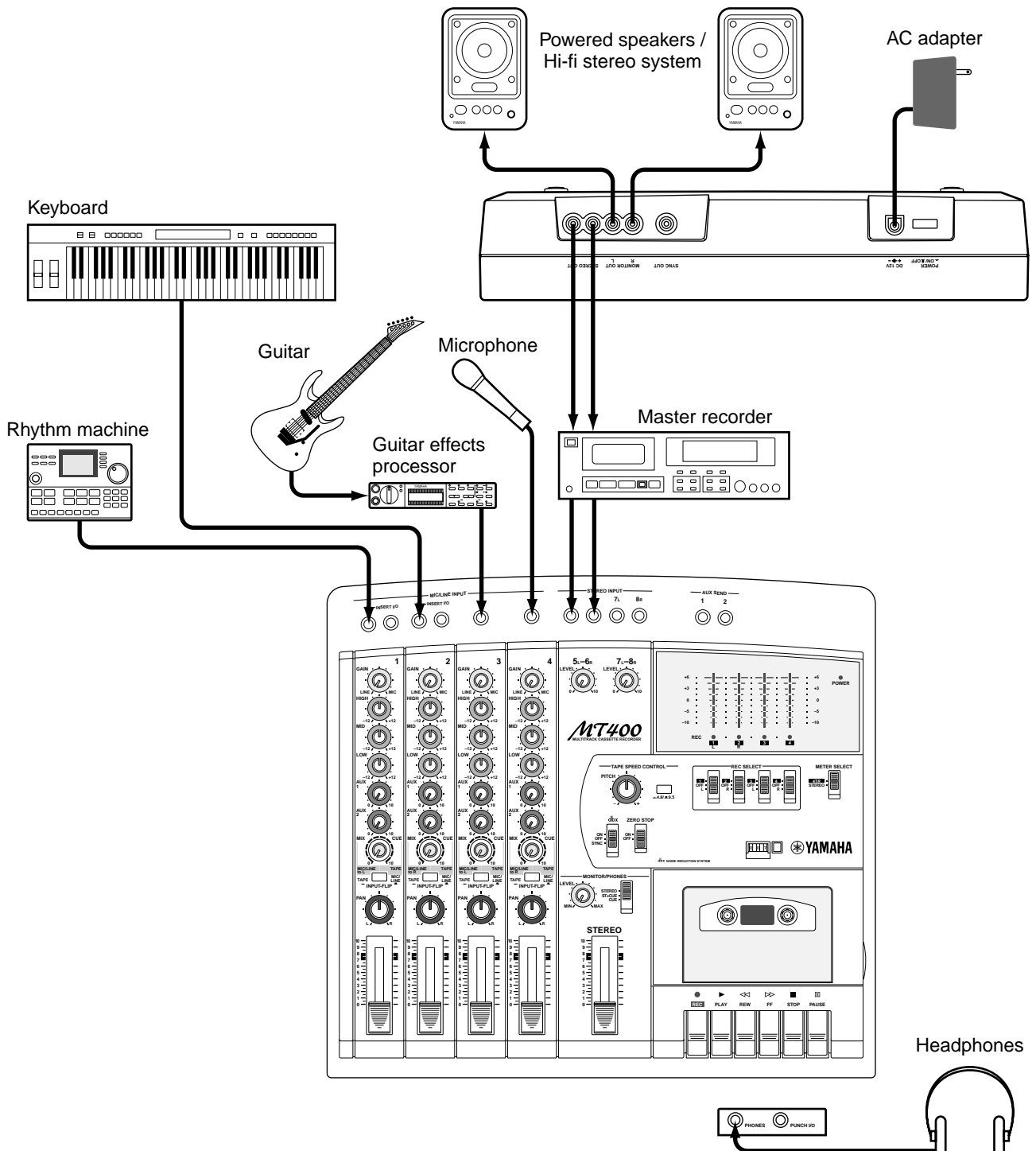

Turning On the MT400

1. Make sure that the plug of the supplied AC adapter is securely connected to the DC12V jack on the rear of the MT400.
2. Plug the other end of the AC adapter into a suitable AC outlet.
3. Press the POWER switch on the rear panel of the MT400. The POWER indicator in the meter section lights up.

Loading a Cassette Tape

Before loading a cassette tape, make sure the tape is not slack inside the cassette. Also, make sure the write-

protect tabs are not broken. If they are broken, you cannot record on the tape.

1. Open the cassette compartment cover.
 2. Load the cassette into the compartment with the A side facing up.
 3. Close the cassette compartment cover.
- If it is a new tape, fast forward and rewind it once to prevent binding, which may occur due to the tape being tightly wound during manufacturing.
4. Press the [PLAY] button to start playback, and stop after about 20 seconds.

It is best not to use the first and last 20 seconds of a tape, as the splice between the leader and tape can cause distortion.

Recording the First Track

The MT400 allows signals input at MIC/LINE INPUT 1–4 to be directly recorded on Tracks 1–4 respectively (this is called “direct recording”). Connecting a sound source to MIC/LINE INPUT 1 will automatically select Track 1 for recording, and connecting another sound source to MIC/LINE INPUT 3 will automatically select Track 3 for recording. This is convenient for recording one sound source at a time.

This section explains how to record the first sound source in Track 1.

Preparation Before Recording

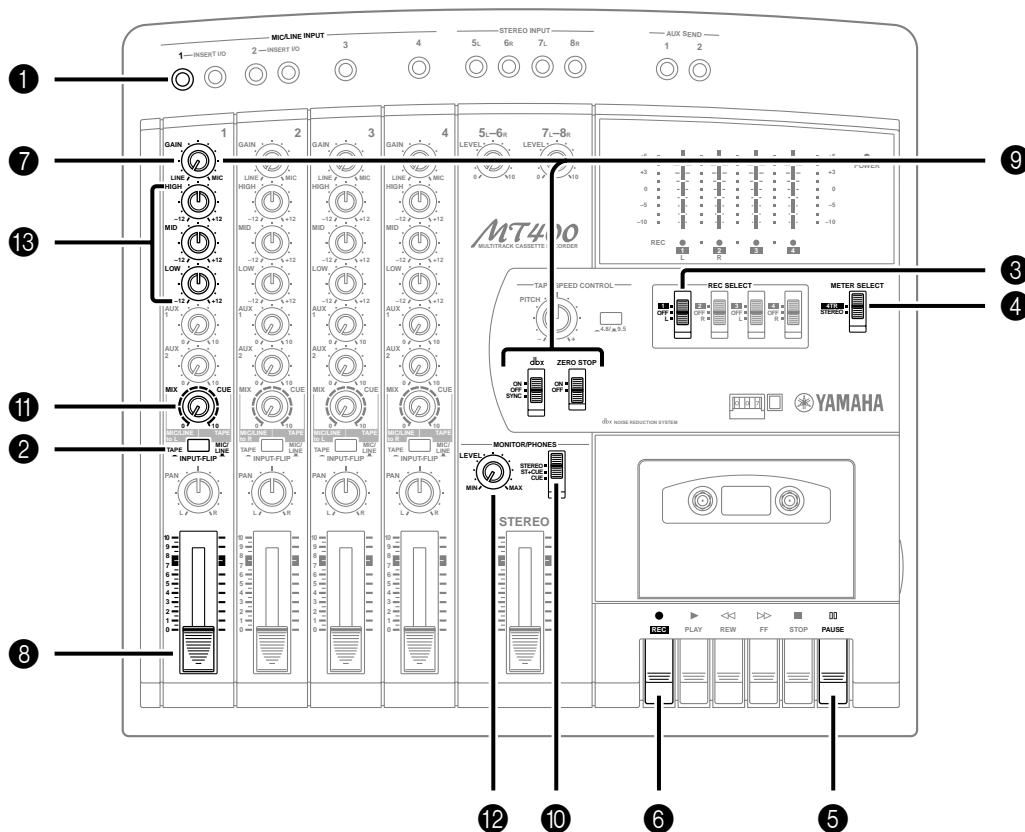



Selecting a recording track

- ① Connect a sound source to MIC/LINE INPUT 1.

It is best to record a rhythm instrument, such as a rhythm machine, drums, or a rhythm guitar, first.



- ② Set the [INPUT-FLIP] switch on Input Channel 1 to "MIC/LINE ()".

This switch setting sends the MIC/LINE INPUT signal to the corresponding input channel.

- ③ Set Track 1 [REC SELECT] switch to "". The [REC SELECT] switches enable you to select a recording source for each track. With Track 1 [REC SELECT] switch set to "", Track 1 is ready for recording, and the signal on Input Channel 1 is sent to Track 1. Also, the Track 1 REC SELECT indicator flashes.

Checking the recording level

It is essential to set an appropriate recording level to achieve the best sound quality. Be sure to adjust the recording level before each recording session.

- ④ Set the [METER SELECT] switch to "". The [METER SELECT] switch is used to select a signal monitored on the level meters. With the "" setting, you can monitor the input level of the recording source on the recording/recording-pause tracks, and the tape signal level on the playback tracks.

- ⑤ Press the [PAUSE] button.

- ⑥ Press the  button.

The Track 1 REC SELECT indicator stops flashing and lights up continuously, and the MT400 enters recording pause mode. Since you pressed the [PAUSE] button, recording does not start.

- ⑦ Turn the GAIN control on Input Channel 1 all the way to LINE.

- ⑧ Raise the fader on Input Channel 1 up to between marks 7 and 8.

- ⑨ Play the sound source, and turn the GAIN control while checking the level meter to adjust the recording level. Set the [dbx] switch and the [ZERO STOP] switch to "ON".

Adjust the GAIN control so that the +3 segment of the level meter lights up momentarily on the loudest sounds if dbx has been turned off, and the +6 segment of the level meter lights up momentarily if dbx has been turned on.

If the recording level is very high even when the GAIN control is turned all the way to LINE, lower the output level on the sound source.

Monitoring a track recording signal

- ⑩ Set the monitor select switch to "CUE". The monitor select switch enables you to select a monitoring source. The "CUE" setting sends the CUE bus signal (monaural) to the connected audio system or headphones for monitoring via the PHONES and MONITOR OUT jacks.

- ⑪ Set the CUE control on Input Channel 1 midway around noon.

The CUE controls on Input Channels 1–4 adjust the level of the signals (recording source signals on the recording/recording-pause tracks, and tape signals on the playback tracks) that are sent from Tracks 1–4 to the CUE bus.

- ⑫ While monitoring the signal through the headphones or the audio system, use the MONITOR LEVEL control to adjust the monitoring sound to the desired level.

- ⑬ If necessary, use the EQ controls to adjust tonal quality.

Adjusting the EQ controls will change the recording level as well. After you adjust the EQ controls, adjust the GAIN control for the recording level again, if necessary.

The First Take

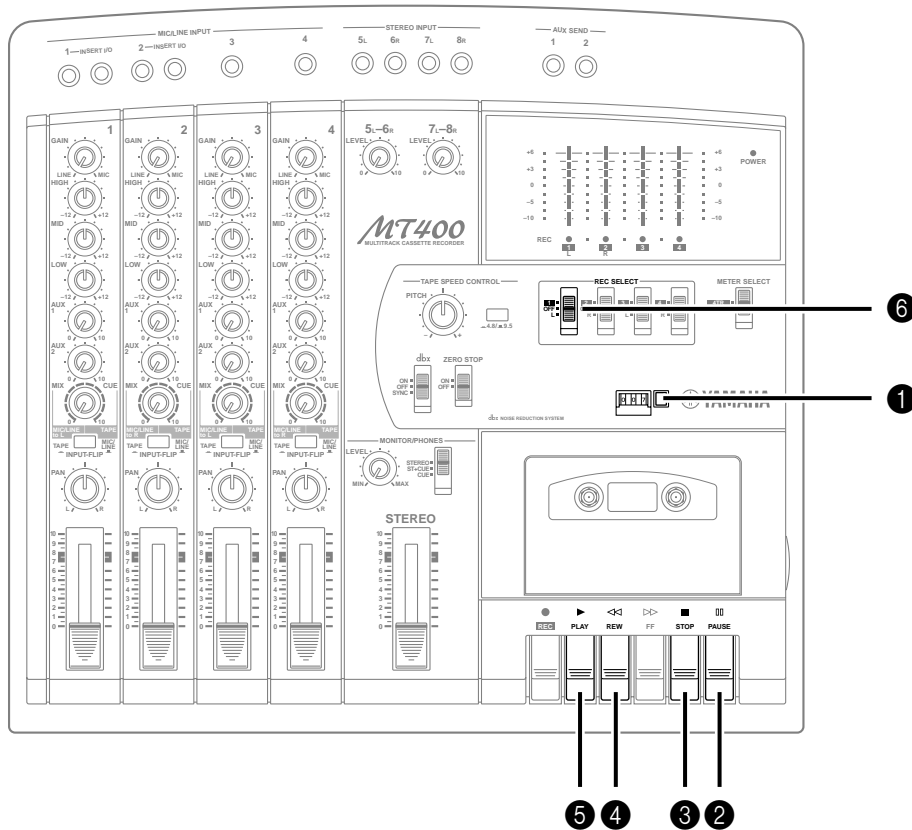

Starting recording

- ① Press the counter reset button to set the tape counter to "000".
- ② Press the [PAUSE] button to cancel pause mode.
This starts recording. Play the sound source for recording.
- ③ Press the [STOP] button to stop recording.
The Track 1 REC SELECT indicator flashes.

Listening to the first track

- ④ Press the [REW] button to rewind the tape. If the [ZERO STOP] switch is set to ON, the tape rewinds until the tape counter shows "000" and stops automatically.
- ⑤ Press the [PLAY] button to start playback. If the [INPUT-FLIP] switch on Input Channel 1 is set to "MIC/LINE ()", you can monitor the Track 1 playback sound (sent via the CUE bus) through the PHONES or MONITOR OUT jack.
To record again, rewind the tape to the beginning and press the **REC** button. If you wish to re-record part of the recording, perform punch in/out recording. See page 34 for more information.
- ⑥ If you are satisfied with your first take on Track 1, set the [REC SELECT] switch on Track 1 to "OFF".
The Track 1 REC SELECT indicator turns off.

Note: Be sure to turn the [REC SELECT] switch on Track 1 to “OFF”. Otherwise, recording on Track 1 will be erased when you record the next track.

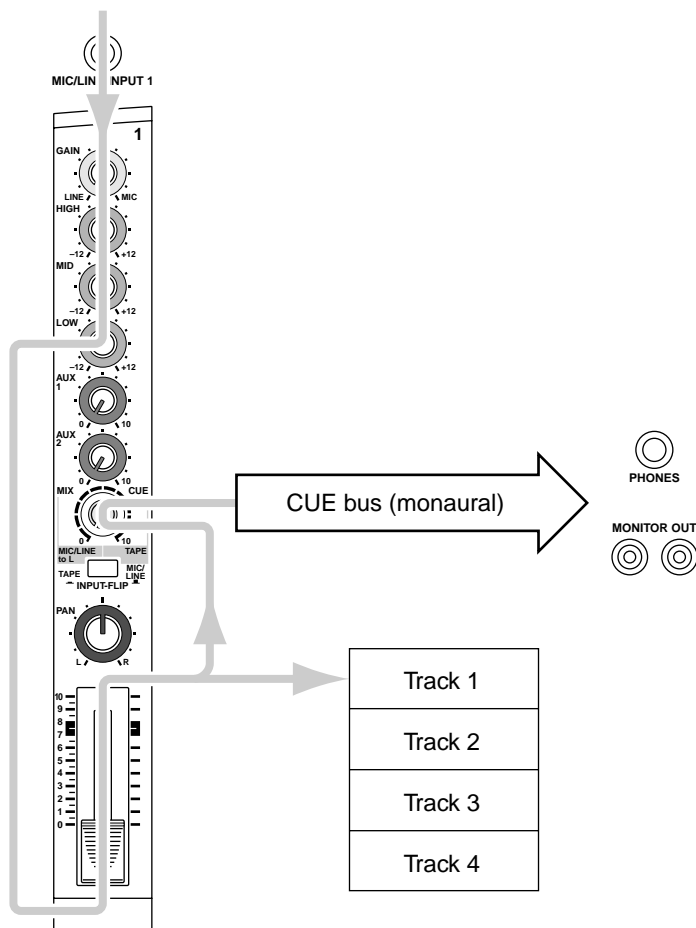



Signal flow during track recording

Overdubbing

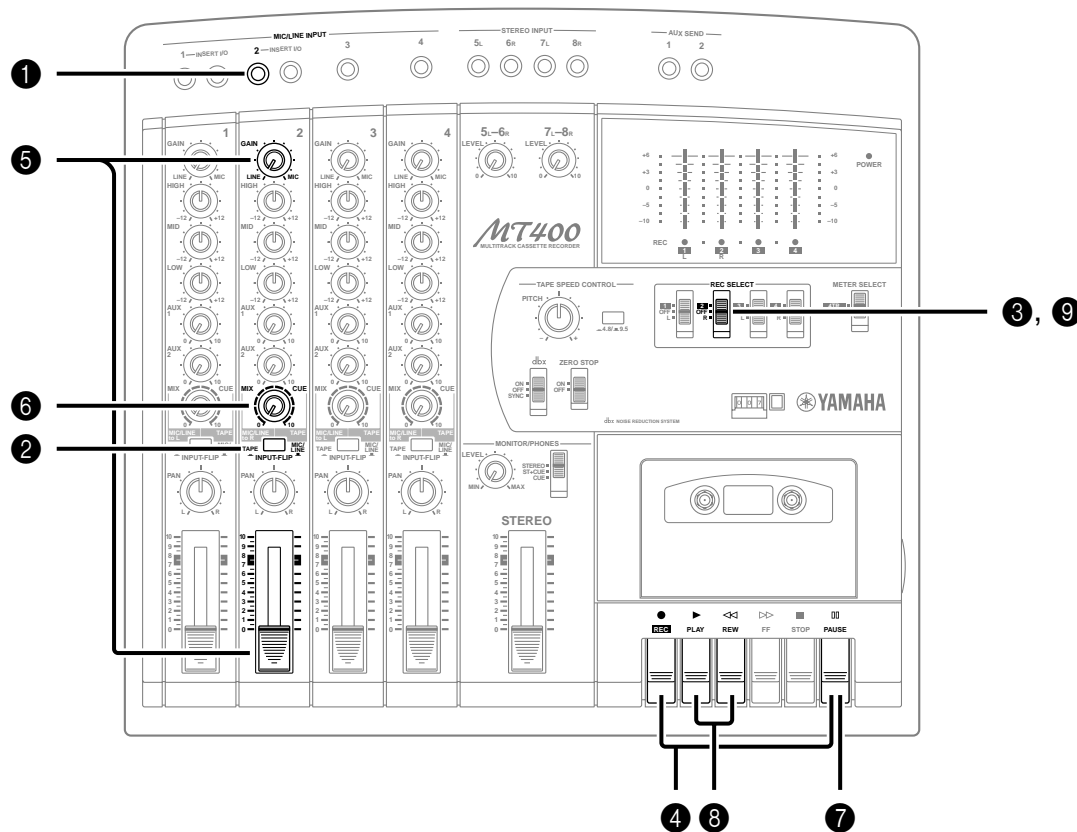
You may record a different sound source to another track while listening to the sound recorded on Track 1. The basic procedure for overdubbing is the same as the first take.



Selecting a recording track

- ① Connect a sound source to MIC/LINE INPUT 2.
- ② Set the [INPUT-FLIP] switch on Input Channel 2 to "MIC/LINE ()".
Leave the [INPUT-FLIP] switch on Input Channel 1 to "MIC/LINE ()".
- ③ Set Track 2 [REC SELECT] switch to "  ".
The Track 2 REC SELECT indicator flashes and Track 1 is ready for recording.

Note: Make sure that the [REC SELECT] switch on Track 1 is set to "OFF".

- ④ Press the [PAUSE] button, then the **REC** button.
- ⑤ While checking the level meter, use the GAIN control and fader on Input Channel 2 to set the optimum recording level.

Monitoring the recording source and tape playback sound simultaneously

- ⑥ While playing the recording source, turn up the CUE control on Input Channel 2.
CUE control 2 adjusts the monitoring level of the signal recorded on Track 2. Adjust to a desired level while listening to the sound through headphones or monitor speakers. When you start recording, Track 1 playback sound and Track 2 recording source will be mixed into a monaural signal and sent to the CUE bus for monitoring.

Start recording

- ⑦ Press the [PAUSE] button to start recording. Press the [STOP] button to stop recording.

Listening to the recording

- ⑧ Press the [REW] button to rewind the tape to the beginning and press the [PLAY] button to start playback.
- ⑨ If you are satisfied with your recording, set the [REC SELECT] switch on Track 2 to "OFF". Repeat this procedure until you have recorded all tracks.

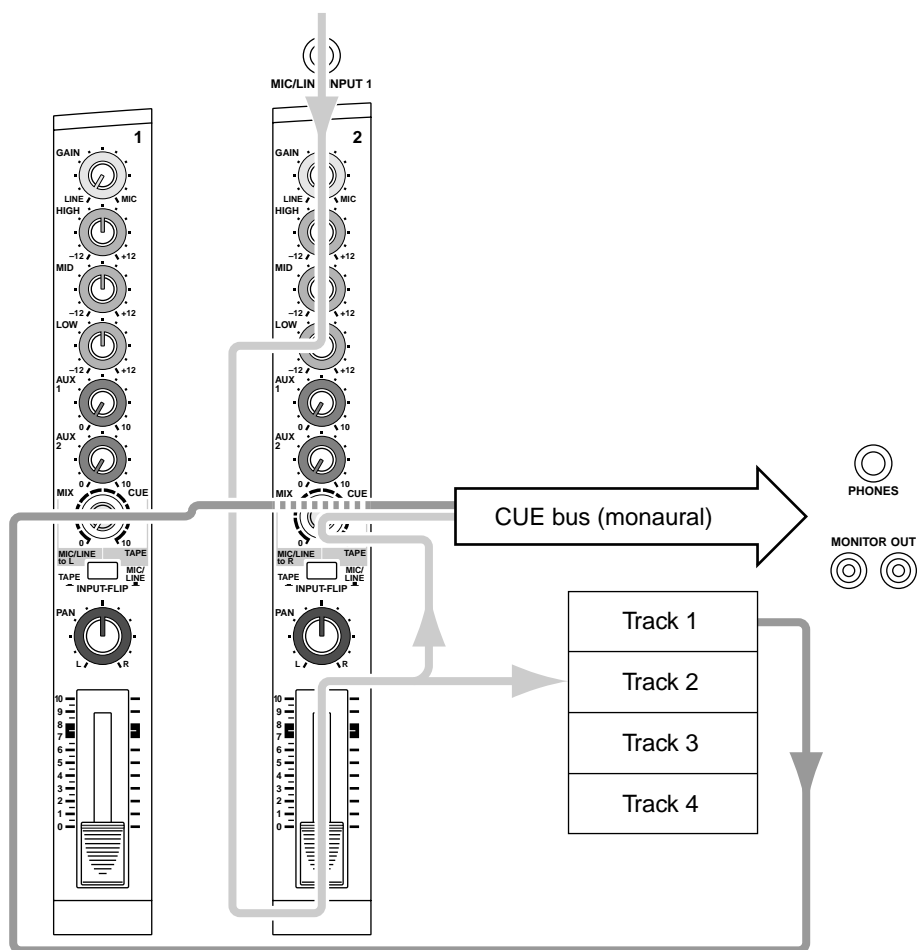

Signal flow during overdubbing

Mixdown

After you have recorded all tracks, you are ready to mix them into a stereo mix, which you will record to a stereo master recorder.

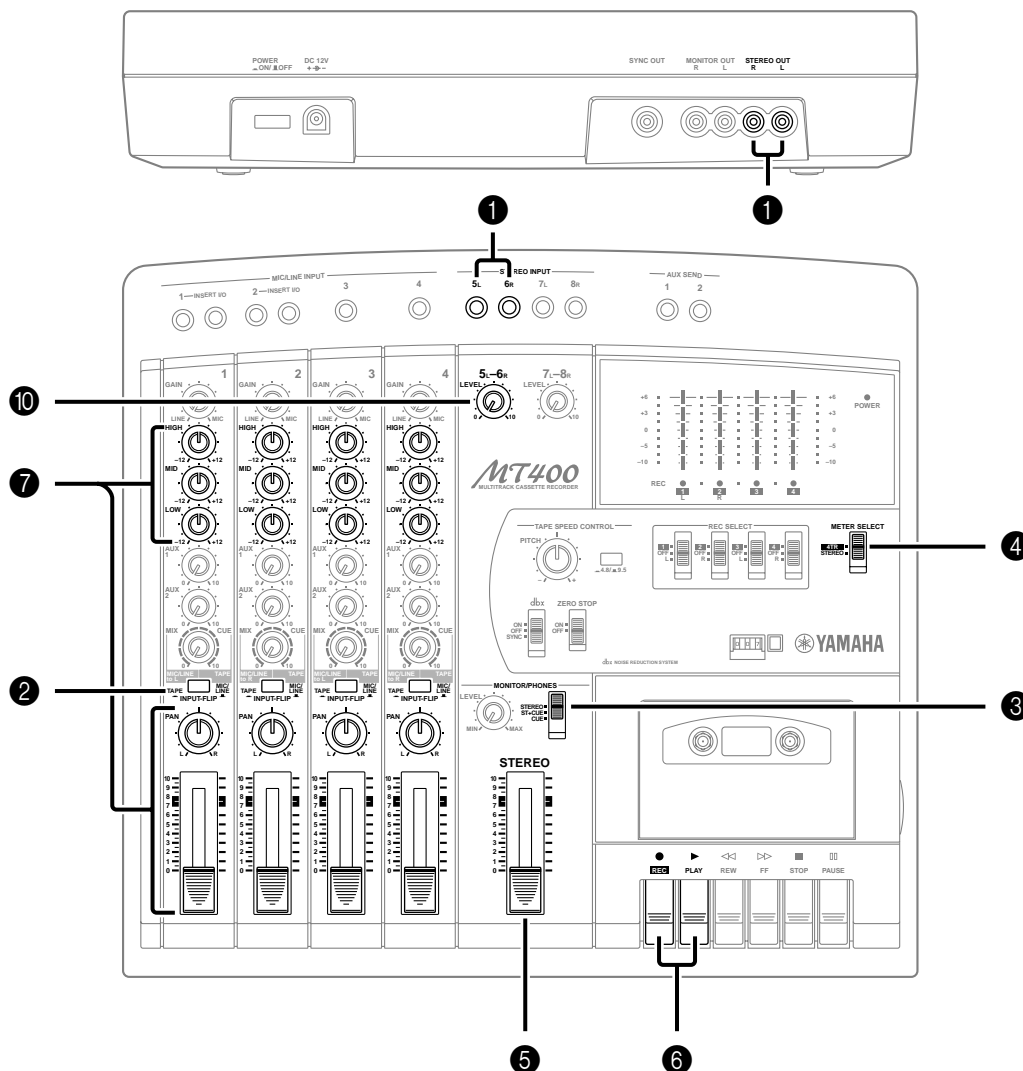

Connecting a master recorder

- 1 Connect the STEREO OUT jacks on the rear panel of the MT400 to the input jacks of a master recorder, and connect the output jacks of the master recorder to the STEREO INPUT 5L/6R jacks on the top panel of the MT400.

Sending the tape playback sound to the input channels

- 2 Set the [INPUT-FLIP] switches on Input Channels 1–4 to “TAPE (

are sent to the input channels, where you can adjust tonal quality with the EQ controls and stereo position with the PAN control. The playback sound sent to Input Channels 1–4 are routed to the STEREO bus for stereo mix and output from the STEREO OUT jacks.

- 3 Set the monitor select switch to “STEREO”. The stereo bus is selected as a monitoring source, and you can listen to the STEREO OUT signals via headphones or an audio system connected to the PHONES or MONITOR OUT jacks.
- 4 Set the [METER SELECT] switch to “STEREO”. The level meters L and R on the left indicate the level of the Stereo bus signal output from the STEREO OUT jacks.

- 5 Raise the STEREO fader to the 7–8 mark.
- 6 Press the [REW] button to rewind the tape, and press the [PLAY] button to start playback.
- 7 While listening to the headphones or the monitor speakers, adjust the faders, PAN controls, and EQ controls on Input Channel 1–4.

First use the faders to adjust level balance between tracks, so that the +3 segments of the level meters light up momentarily at the loudest peaks. Use the STEREO fader, if necessary, for fine adjustments. Then use the PAN controls to set the stereo position. Finally, use the EQ controls to adjust the tonal quality to refine your music, and re-adjust the volume level, if necessary.

Recording to a master recorder

Record the final mix to a stereo master recorder.

- 8 Start recording on the master recorder and start playback from the top of the song on the MT400.
- 9 When you finish mixdown, stop the MT400 and the master recorder.
- 10 Play the master recorder from the beginning and turn the LEVEL control 5–6 for STEREO INPUTs to listen to the mix.

To listen to the mix recorded on the master recorder, you need to connect the output jacks of the master recorder to STEREO INPUTs 5 and 6 of the MT400 to monitor via the Stereo bus. To adjust the monitoring level, use the LEVEL control 5–6 for STEREO INPUTs and the STEREO fader.

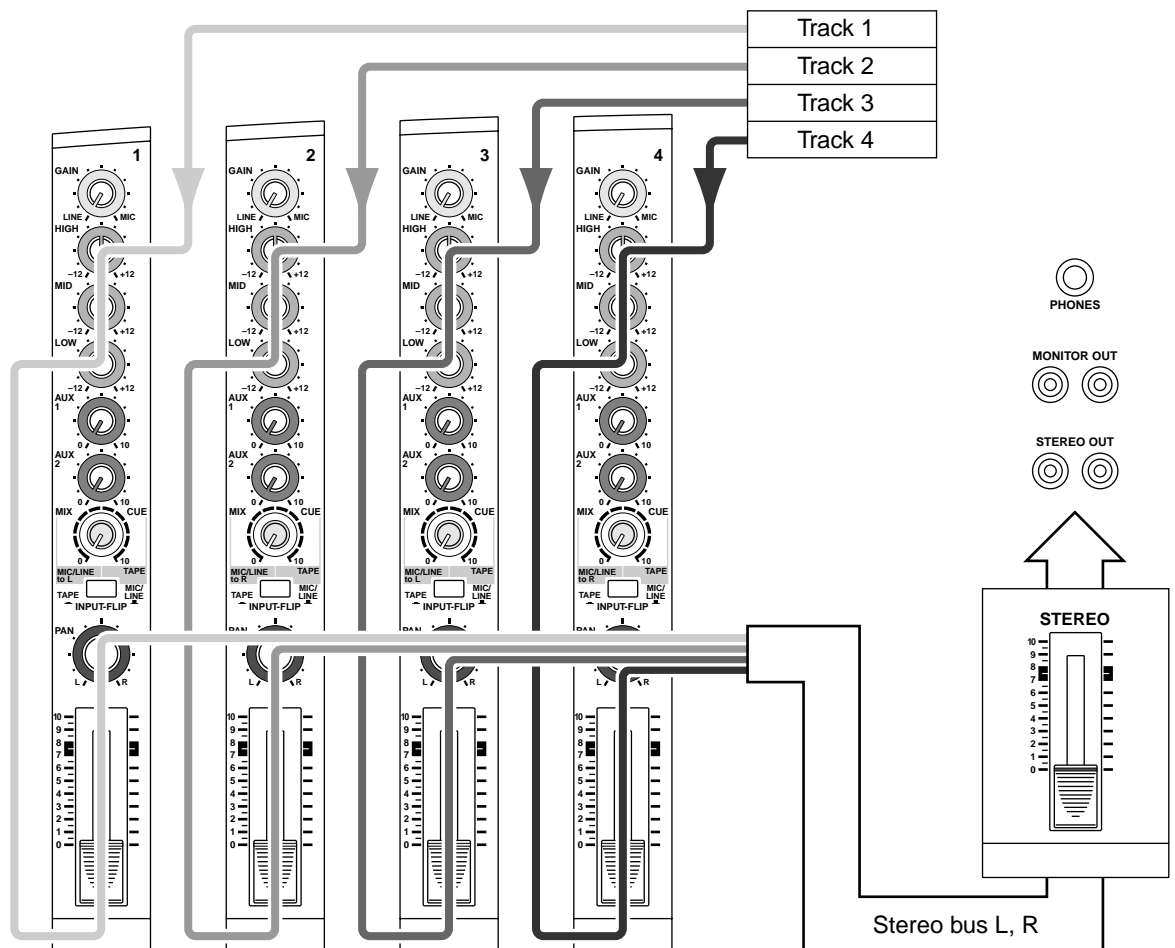

Signal flow during mixdown

Advanced Recording Techniques

This chapter introduces you to various advanced recording techniques using the MT400.

Simultaneous Multi-Channel Recording

In addition to recording four tracks individually as explained earlier, you may sometimes wish to record multiple sound sources to a track or two. (For example, you may wish to record drum, bass, and rhythm guitar sounds to two tracks in stereo.) To do this, you can mix input channel signals into a stereo mix via the Stereo bus, and record the mix to two tracks. The following procedure explains how to mix four sound sources connected to MIC/LINE INPUTS 1–4 into stereo and record the mix to Tracks 1 and 2.

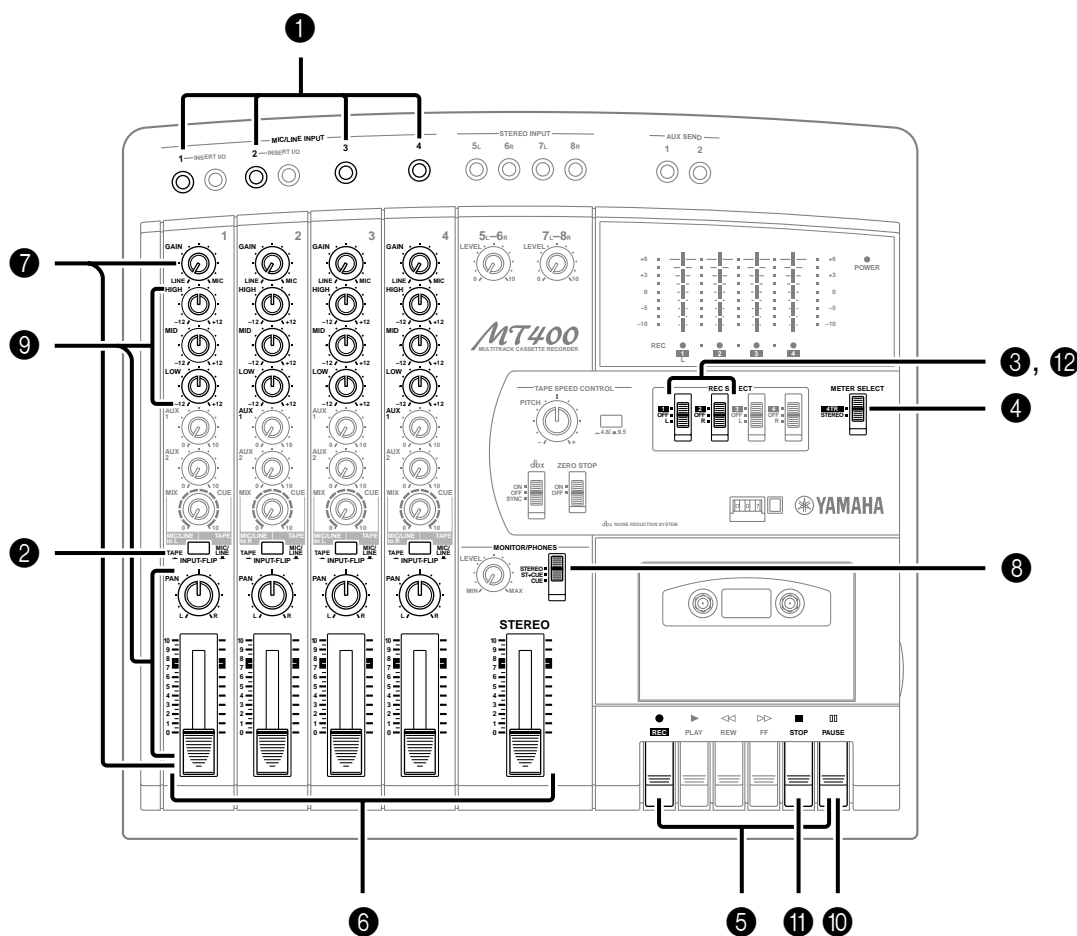

1 Connect sound sources to MIC/LINE INPUTS 1–4.

You can also mix the sound of a line-level instrument, such as a synthesizer, connected to STEREO INPUTS 5L/6R or 7L/8R.

2 Set the [INPUT-FLIP] switches on Input Channels 1–4 to “MIC/LINE ()”.

3 Set the [REC SELECT] switches on Tracks 1–2 to “L” and “R” respectively.

Tracks 1 and 2 REC SELECT indicators flash.

With the [INPUT-FLIP] switches set to “MIC/LINE ()”, Input Channels 1–4 signals are sent to the Stereo bus. Setting the [REC SELECT] switches to “L” and “R” selects the L channel and the R channel of the Stereo bus signal respectively as recording sources. In this example, the L channel signal is selected for Track 1, and the R channel signal is selected for Track 2.

4 Set the [METER SELECT] switch to “**4TR**”.

5 Press the [PAUSE] button, then the **REC** button. Tracks 1 and 2 REC SELECT indicators light up continuously and the MT400 enters recording pause mode.

6 Set the fader on each input channel and the STEREO fader to the 7–8 mark.

7 While checking the level meters, adjust the recording level using the GAIN controls and faders on Input Channels 1–4, and the STEREO fader. Also adjust the stereo position of the sound sources using the PAN controls on Input Channels 1–4.

It is best to first play each source while adjusting the GAIN controls, then use the input channel faders and the STEREO fader to obtain a good balance between the sounds.

8 Set the monitor select switch to “CUE” and use the CUE controls to adjust the monitoring level on Tracks 1 and 2.

You can monitor the recording sources for Tracks 1 and 2 (in this example, Input Channel 1–4 signals) via the CUE bus.

Note: The CUE bus monitoring signal is monaural. If you wish to monitor a stereo signal, set the monitor select switch to “STEREO” to select the Stereo bus instead of the CUE bus. (This is convenient if you wish to check the stereo position of each channel.)

9 Adjust the level and pan of each channel signal while monitoring the sound through the headphones or the audio system. Adjust tonal quality, if necessary, with the EQ controls.

10 Press the [PAUSE] button to cancel pause mode and start recording.

11 Press the [STOP] button to stop recording. Tracks 1 and 2 REC SELECT indicators flash.

12 Rewind the tape to the beginning and listen to the recording.

If you are satisfied with the recording, set the [REC SELECT] switches on Tracks 1 and 2 to “OFF”.

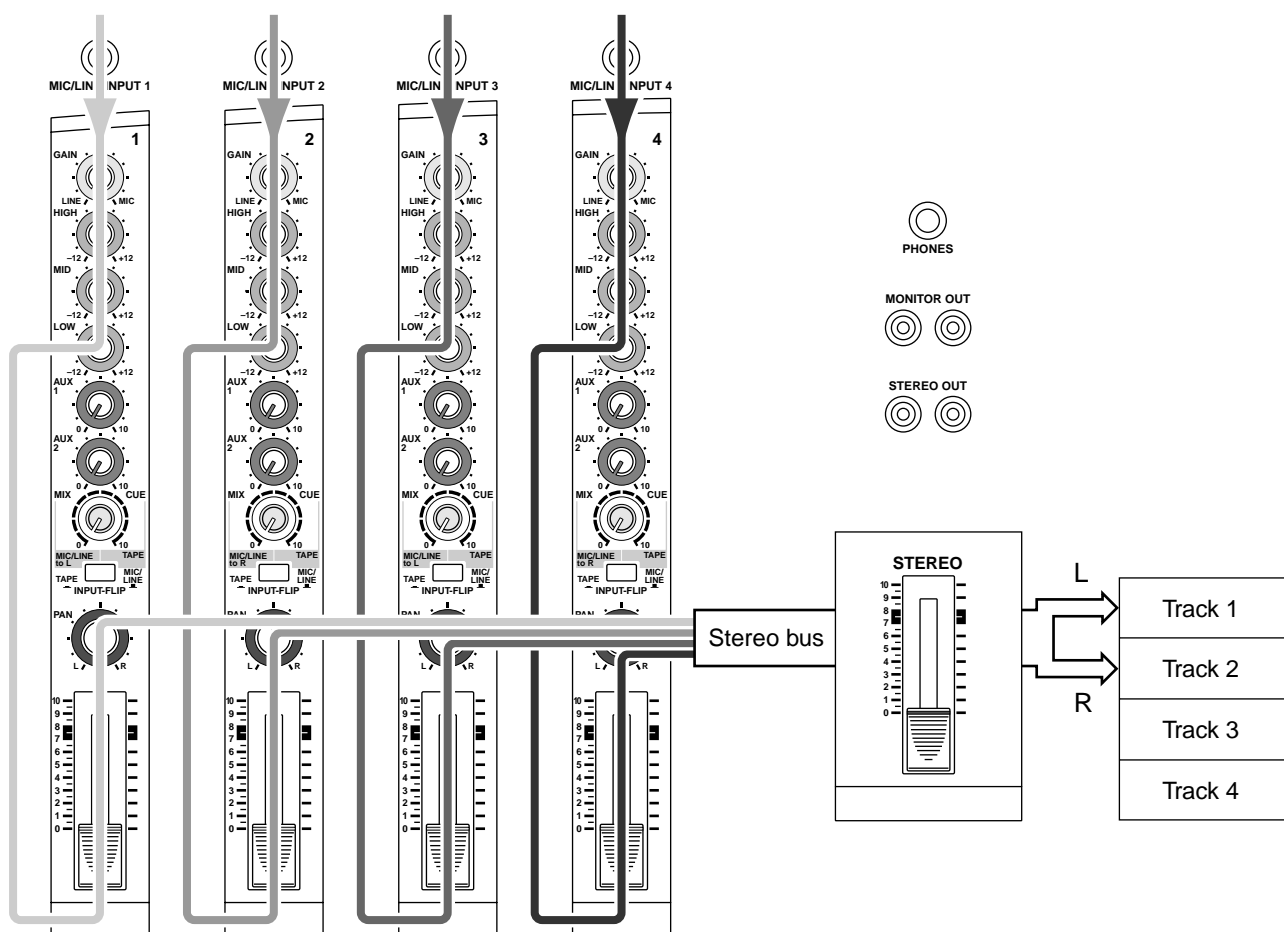

Signal flow during multi-channel mixing

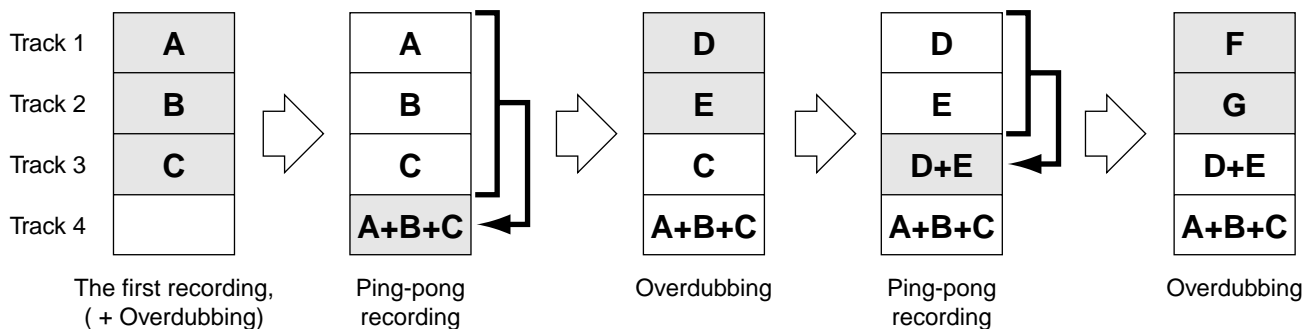

Ping-Pong Recording

The ping-pong recording technique allows you to mix and record several tracks onto another empty track. This is often used to free up tracks for more recording, since those original tracks are then used for further recording. This technique is useful when you wish to record many different instruments or sound sources individually. The following illustration shows that the ping-pong technique and overdubbing allows you to record seven sound sources.

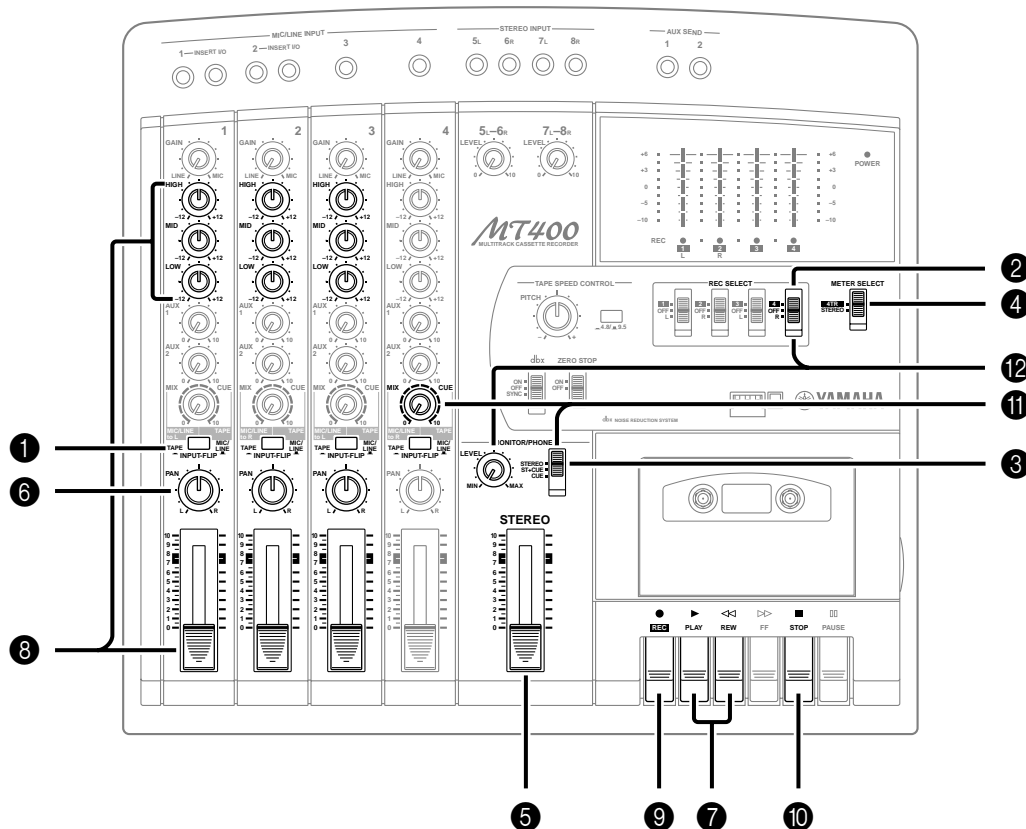

This section explains how to mix and record existing Tracks 1–3 data onto Track 4 as an example.



- 1 Set the [INPUT-FLIP] switches on Input Channels 1–3 to "TAPE ()", and the [INPUT-FLIP] switch on Input Channel 4 to "MIC/LINE ()".

Playback sound on Tracks 1–3 is sent via Input Channels 1–3 to the Stereo bus.

- 2 Set the [REC SELECT] switch on Track 4 to "R".

The Track 4 REC SELECT indicator flashes, and the R channel of the Stereo bus signal is selected as a recording source for Track 4. Set the [REC SELECT] switches on Tracks 1–3 to "OFF".

- ③ Set the monitor select switch to "STEREO". The Stereo bus signal is selected as a monitoring source, which enables you to listen to the playback on Tracks 1–3 through the headphones or the audio system.
- ④ Set the [METER SELECT] switch to "STEREO".
- ⑤ Set the STEREO fader to the 7–8 mark.
- ⑥ Turn the PAN controls on Input Channels 1–3 all the way to the right (R).
- ⑦ Press the [REW] button to rewind the tape, and press the [PLAY] button to start playback.
- ⑧ While listening to the headphones or the monitor speakers, adjust the faders on Input Channels 1–3 to set the track balance. Use the EQ controls, if necessary, to adjust tonal quality.
- ⑨ After you set the optimum recording level, press the **REC** button to start ping-pong recording.
- ⑩ Press the [STOP] button to stop ping-pong recording, and rewind the tape to the beginning.
- ⑪ Set the monitor select switch to "CUE" and set the CUE control on Input Channel 4 midway (around "noon").
At this time, turn the CUE controls on Input Channels 1–3 all the way to 0.
- ⑫ Play the tape from the beginning and listen to the playback on Track 4 while adjusting the monitoring level with the MONITOR LEVEL control.

Note: Use caution when you set the ping-pong recording level. If the output level is too high, Track 4 may sometimes generate an oscillating noise.

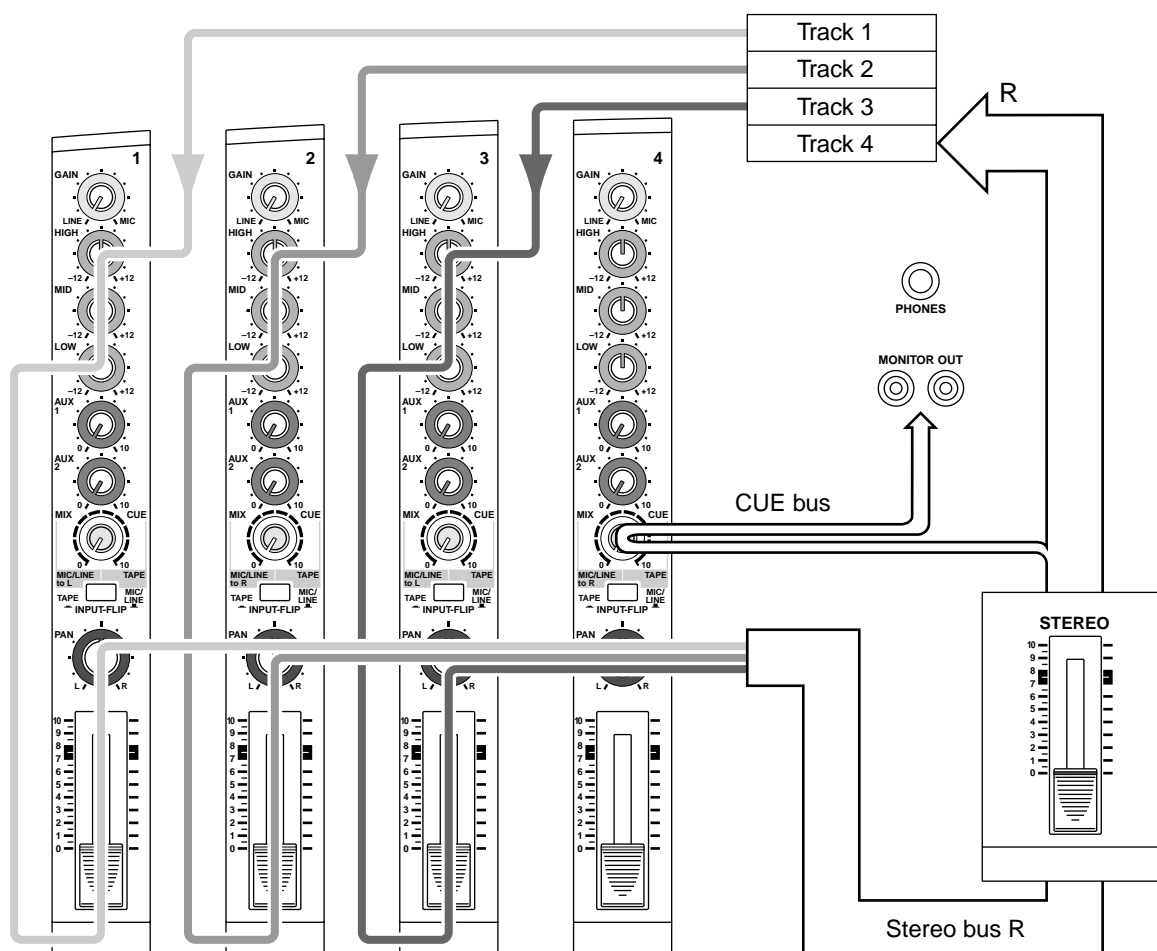



Signal flow during ping-pong recording

Multi-Source Mixing

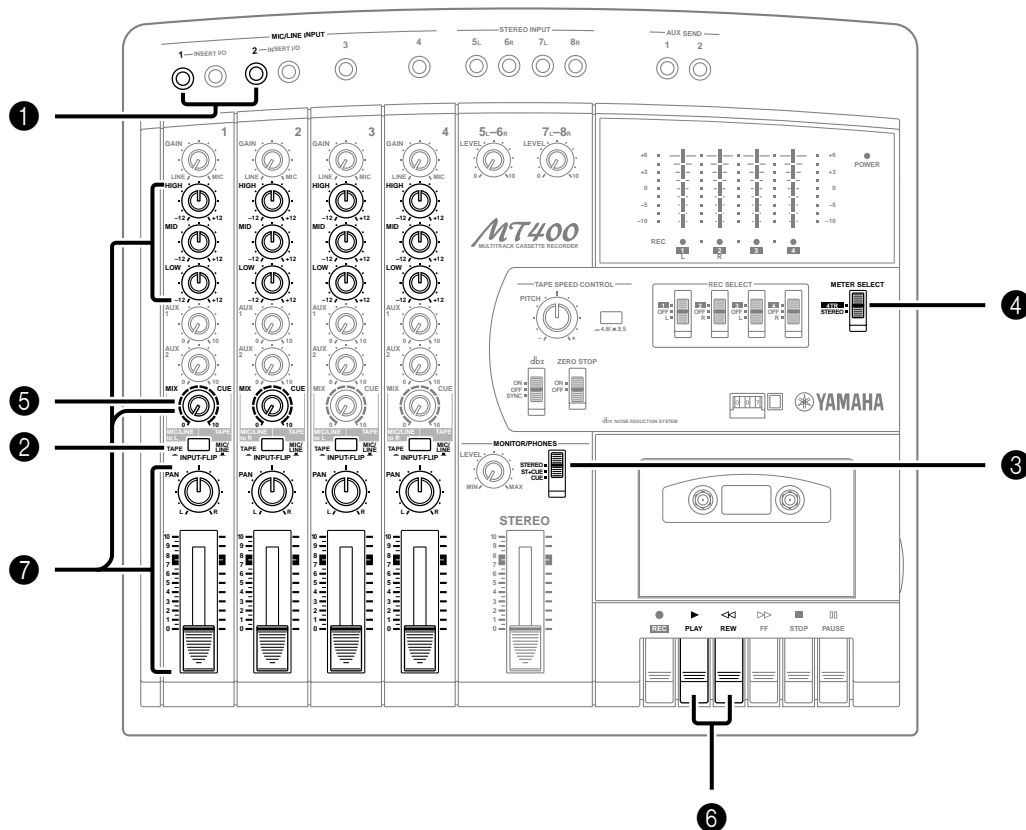
The mixer section of the MT400 enables you to control input signals and tape playback signals simultaneously. For example, you can mix external sound sources with tape tracks. This technique is useful when you wish to add pad or decorative notes to the introductory part of a completed song. This section explains how to mix the sound sources connected to MIC/LINE INPUTs 1 and 2 in addition to the tape tracks.



- ① Connect the sound sources to MIC/LINE INPUTs 1 and 2.
 - ② Set the [INPUT-FLIP] switches on Input Channel 1–4 to “TAPE ()”.
- With the [INPUT-FLIP] switches set to “TAPE ()”, the MIC/LINE INPUT signals are sent to the Stereo bus as follows.

MIC/LINE INPUTs 1 and 3

Sent to the L channel of the Stereo bus.

MIC/LINE INPUTs 2 and 4

Sent to the R channel of the Stereo bus.

Note: You can also mix the STEREO INPUT signals for mixdown. In this case, signals at STEREO INPUT 5L/7L are sent to the L channel, and signals at STEREO INPUT 6R/8R are sent to the R channel.

- ③ Set the monitor select switch to “STEREO”.
- ④ Set the [METER SELECT] switch to “STEREO”.
- ⑤ Play the sound sources connected to MIC/LINE INPUTs 1 and 2, and adjust the input levels with the CUE controls on Input Channels 1 and 2.

When the [INPUT-FLIP] switch is set to “TAPE ()”, use the corresponding CUE controls to adjust the level of the signals input at MIC/LINE INPUTs.

- 6 Press the [REW] button to rewind the tape, and press the [PLAY] button to start playback.
- 7 While listening to the headphones or the monitor speakers, adjust the faders, PAN controls, and EQ controls on Input Channel 1–4. Also, use the CUE controls on Input Channels 1 and 2 to adjust the level of signals from MIC/LINE INPUTS 1 and 2.
- 8 Start recording on the master recorder and start playing from the top of the song on the MT400.
- After recording, play the master recorder to listen to the mixdown.
- You can add external signals during ping-pong recording using the same procedure. For example, if you mix and record Tracks 1–3 sounds onto Track 4 via the R channel of the Stereo bus, you can connect external sound sources to MIC/LINE INPUTS 2 and 4 or STEREO INPUTS 6R and 8R.

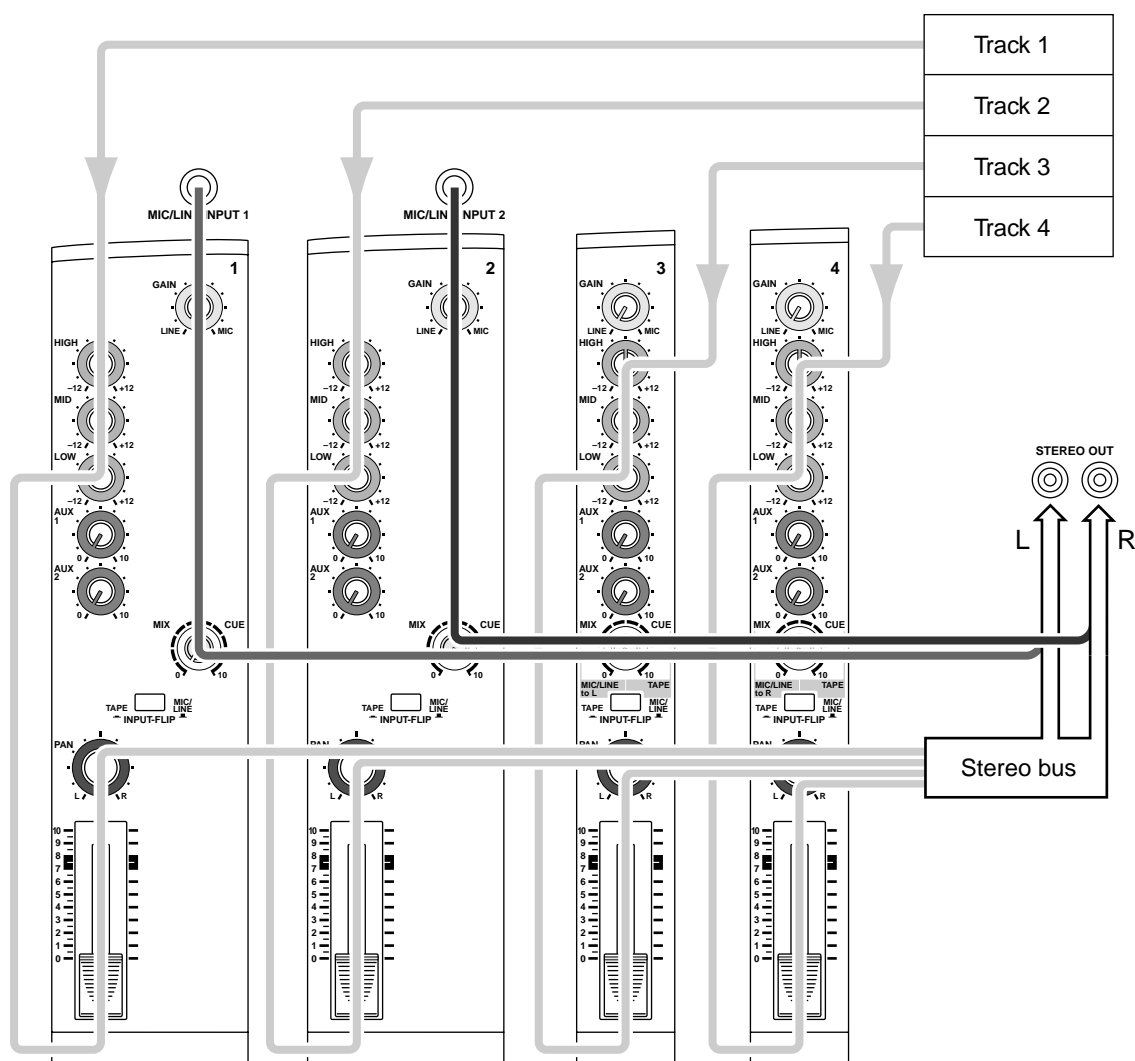

Signal flow during multi-source mixing

Using Effects

This section explains how to connect external effects processors and apply effects to MT400 signals during recording or mixdown. You may use either the INSERT I/O jacks or the AUX SEND jacks to apply effects to input channel signals and tape tracks.

Using INSERT I/O

Input Channels 1 and 2 of the MT400 feature INSERT I/O jacks to connect external effects processors. These make it easy to apply effects to certain channels and tracks during track recording and mixdown. Typically, you can use compressors, limiters, noise gates, equalizers, and other effect units that process dynamics and the tonal color of sound.

The INSERT I/O connections, which use TRS (Tip, Ring, Sleeve) phone jacks are two-way connections, with the tip carrying the input channel signals from the MT400 to the external processor and the ring carrying the processed signal from the external processor back to the input channels of the MT400.

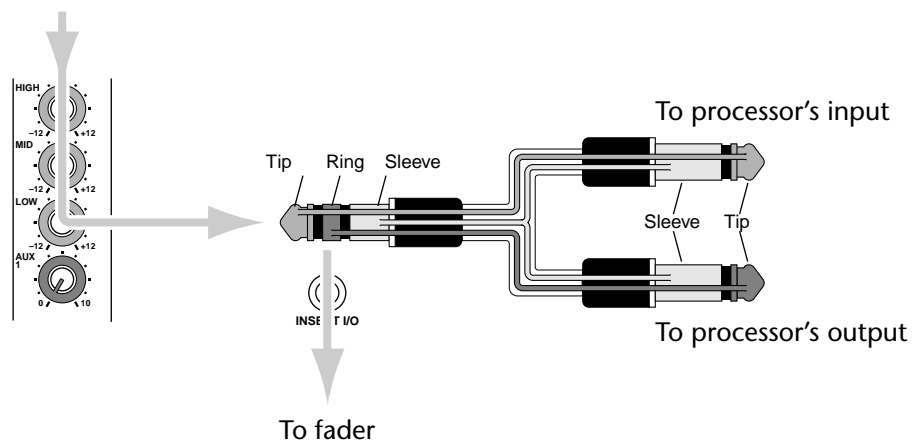

Signal path through the TRS phone jack

You will need a special insert cable as shown above to connect external effects processors to the INSERT I/O jacks. Optional insert cables YIC025/050/070 are available from Yamaha. Refer to the following diagram of the effects processor connection.

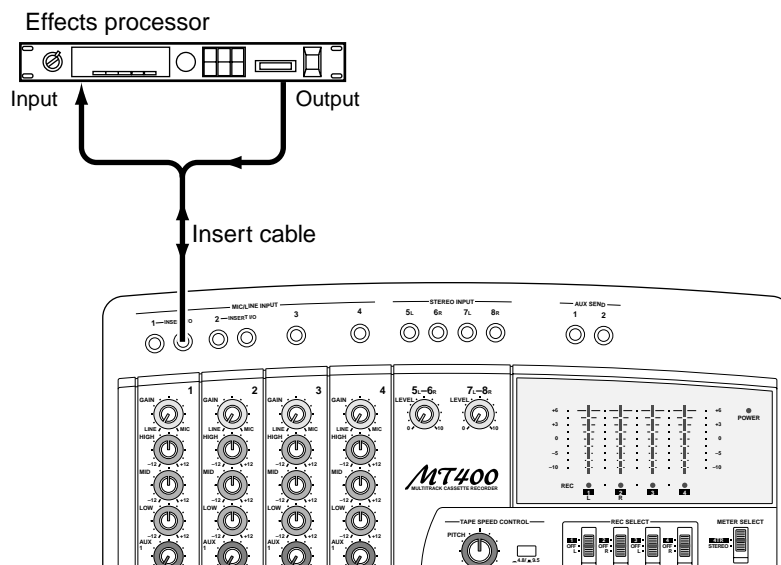

Effects processor connection with an insert cable

Once connected, operation is the same as normal recording and mixdown. Effects are applied to the MIC/LINE INPUT 1 or 2 signal with the [INPUT-FLIP] switch set to “MIC/LINE (■)”. If the [INPUT-FLIP] switch is set to “TAPE (■)”, effects are applied to the Track 1 or 2 signal.

Using AUX SENDS

The AUX SENDS allow you to connect external effects processors and apply effects to MT400 signals. This means that input channels on the MT400 can share the same effects processors. For example, delay and reverb type effects with different intensity settings for each channel (or track) can be applied to several sounds when mixing and recording them onto two tracks or at mixdown.

To use external effects processors with the AUX SENDS jacks, connect AUX SENDS 1 and 2 to the inputs of effects processors and connect the outputs of effects processors to STEREO INPUTS 5L/6R or 7L/8R.

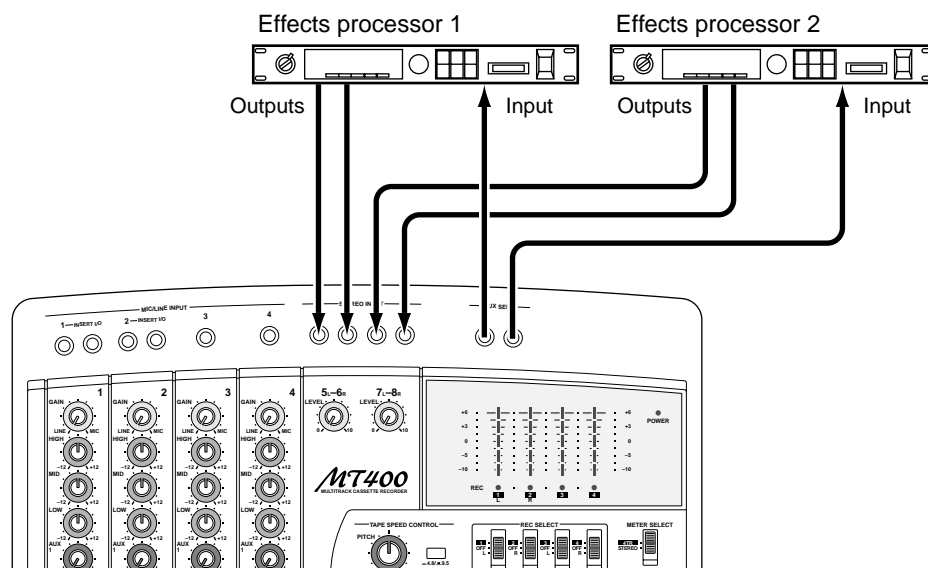



Connecting external effects processors to AUX SENDS

As you turn up the AUX 1/2 controls on the input channels with this configuration, channel signals are mixed into monaural and output from AUX SENDS 1 and 2 to the connected external effects processors. Processed signals output from the effects processors are returned to the Stereo bus via STEREO INPUTS 5L/6R or 7L/8R. Typically, delay, reverb, and chorus type effects, which are applied to an unprocessed signal, are used. With this type of connection, the effects processors should be set so that only the processed signal is returned from the effects processors to the MT400 (through the stereo inputs to the Stereo bus) and mixed with the original, dry signal (which is routed from the input channels to the Stereo bus).

Applying Effects to Multiple Channels When Recording

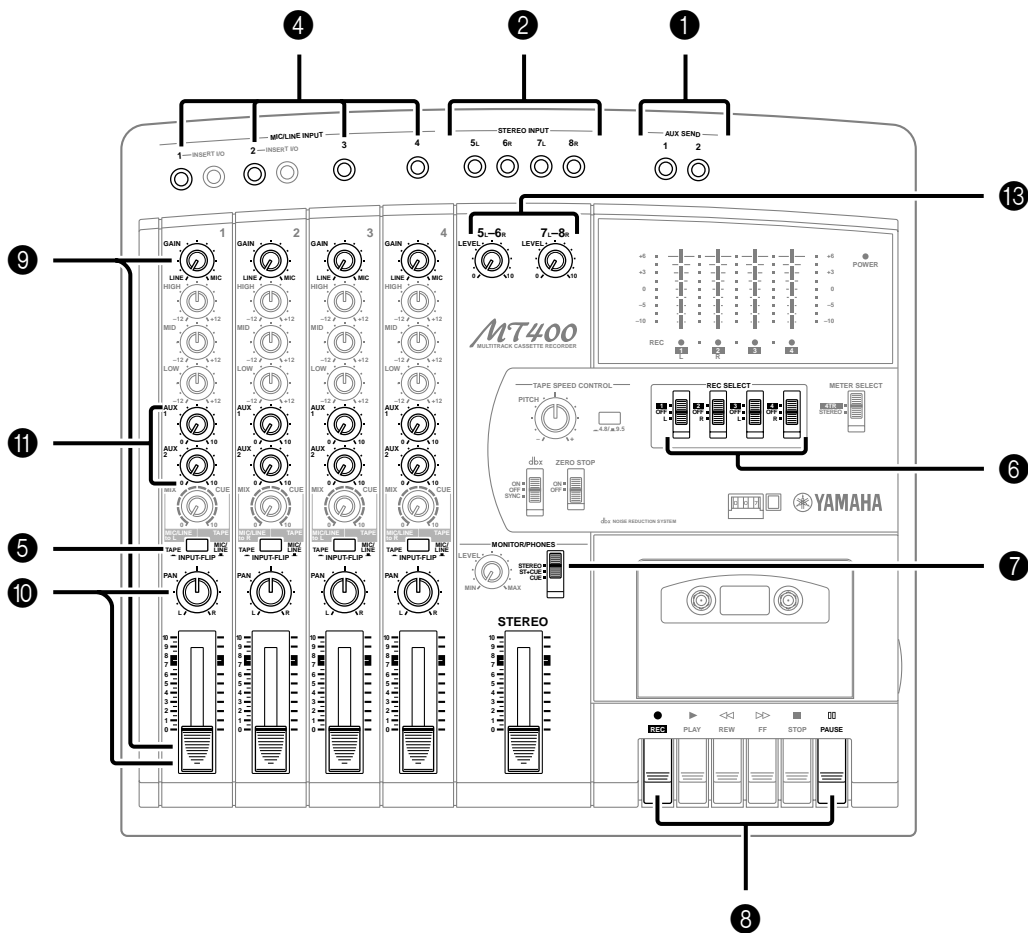
You may sometimes want to apply reverb or delay effects when you mix multiple channels and record them onto a track or two. In this case, use the AUX SEND connection to apply two types of effects to Input Channel 1–4 signals.



- ① Connect AUX SENDs 1 and 2 to the inputs of external effects processors.
- ② Connect the outputs of the effects processors to STEREO INPUTs 5L/6R or 7L/8R.
- ③ Set the effects processors so that they will output only processed signals.
- ④ Connect sound sources to MIC/LINE INPUTs 1–4.
- ⑤ Set the [INPUT-FLIP] switches on Input Channels 1–4 to “MIC/LINE (

The processed sound from the effects processor is mixed into the Stereo bus signal. The more you turn up the LEVEL control, the more the effects sound is mixed, and the greater is the degree of effects.

When you are using AUX SENDs to apply effects during track recording, the Stereo bus is used for recording. With a direct recording setting, the processed signal returned from the effects units to the Stereo bus cannot be recorded.

- ⑦ Set the monitor select switch to “CUE”.
A monaural CUE bus signal is used for monitoring during normal recording. However, if you wish to check the stereo effects sound, set the monitor select switch to “STEREO” to listen to the Stereo bus signal.

- ⑧ Press the [PAUSE] button, then the **REC** button.
- ⑨ While playing the sound sources, use the GAIN controls and faders on Input Channels 1–4, and the STEREO fader to adjust the recording level.
- ⑩ Use the faders and PAN controls on Input Channels 1–4 to achieve a mix balance between sound sources.
- ⑪ While playing the sound sources, turn up the AUX 1 and 2 controls of the input channels to which you wish to apply effects.

As you turn up the AUX 1 control, the corresponding channel signal is sent to the Stereo bus and the effects processor connected to AUX SEND 1. Similarly, as you turn up the AUX 2 control, the corresponding channel signal is sent to the Stereo bus and the effects processor connected to AUX SEND 2.

Note: The signals for the AUX 1 and 2 controls are sourced post-fader. So, as you change the channel faders, the degree of effects changes.

Applying Effects to Only a Monitor Signal

Using a direct recording and the monitor select switch enables you to apply effects to only a monitoring signal while recording the unprocessed sound on a track. For example, you can record a dry vocal on a track, while monitoring the vocalist with reverb effects applied. This section explains how to record a vocal to Track 4 while monitoring Tracks 1–3 as an example.

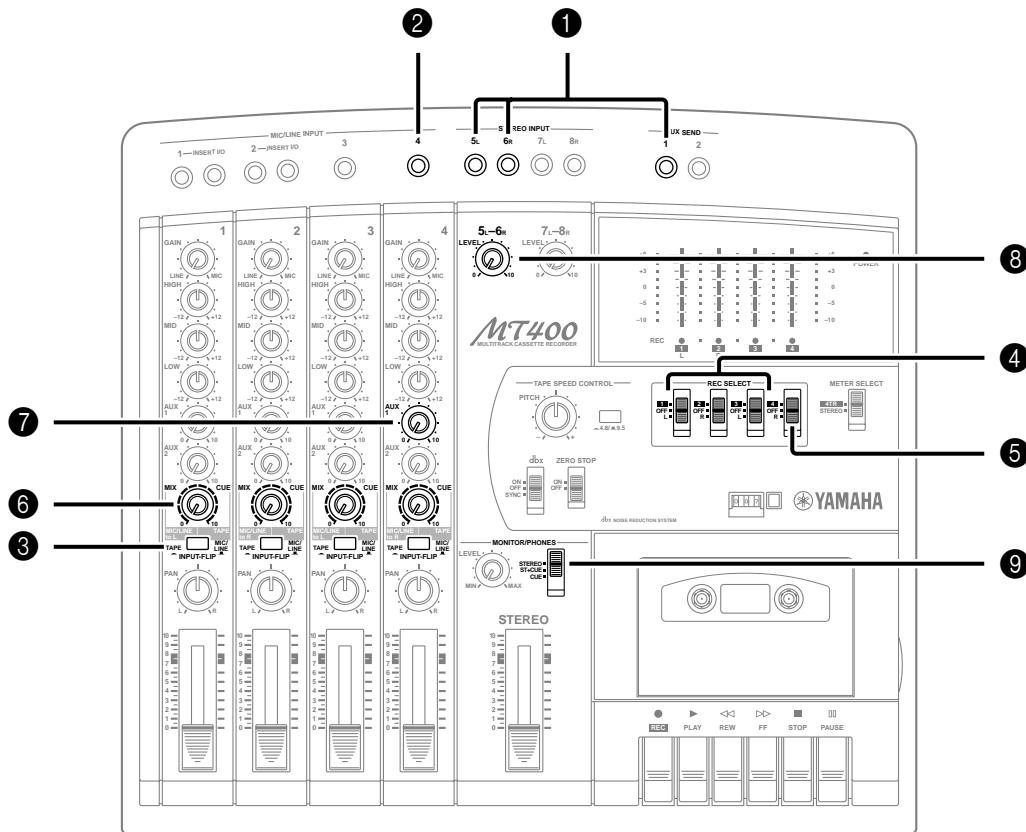

- 1 Connect AUX SEND 1 to the input of the effects processor, and connect the outputs of the effects processor to STEREO INPUTS 5L and 6R. Set the effects processor so that it will output only the processed signal.
- 2 Connect a vocal microphone to MIC/LINE INPUT 4.
- 3 Set the [INPUT-FLIP] switches on Input Channels 1–4 to "MIC/LINE ()".
- 4 Set the [REC SELECT] switches on Tracks 1–3 to "OFF".
- 5 Set the [REC SELECT] switch on Track 4 to "4".
The vocal will be directly recorded on Track 4.
- 6 Turn up the CUE controls on Input Channels 1–4.
You can monitor playback on Track 1–3 and record the source (the vocal without effects) to Track 4 via the CUE bus.
- 7 Turn up the AUX 1 control on Input Channel 4.
The vocal signal is sent to the effects processor connected to the AUX SEND 1 jack.
- 8 Turn up the LEVEL control for stereo inputs 5L/6R.
The processed vocal signal is sent to the Stereo bus.
- 9 Set the monitor select switch to "ST+CUE".
Now you can monitor the CUE bus signals (tape Tracks 1–3 and the dry vocal) mixed with the Stereo bus signal (processed vocal).

Applying Effects at Mixdown

One of the typical uses of external effects processors connected to AUX SENDs is to apply reverb effects to track signals during mixdown. In this case, you can adjust the amount of effects for each track individually using the AUX 1 and AUX 2 controls.

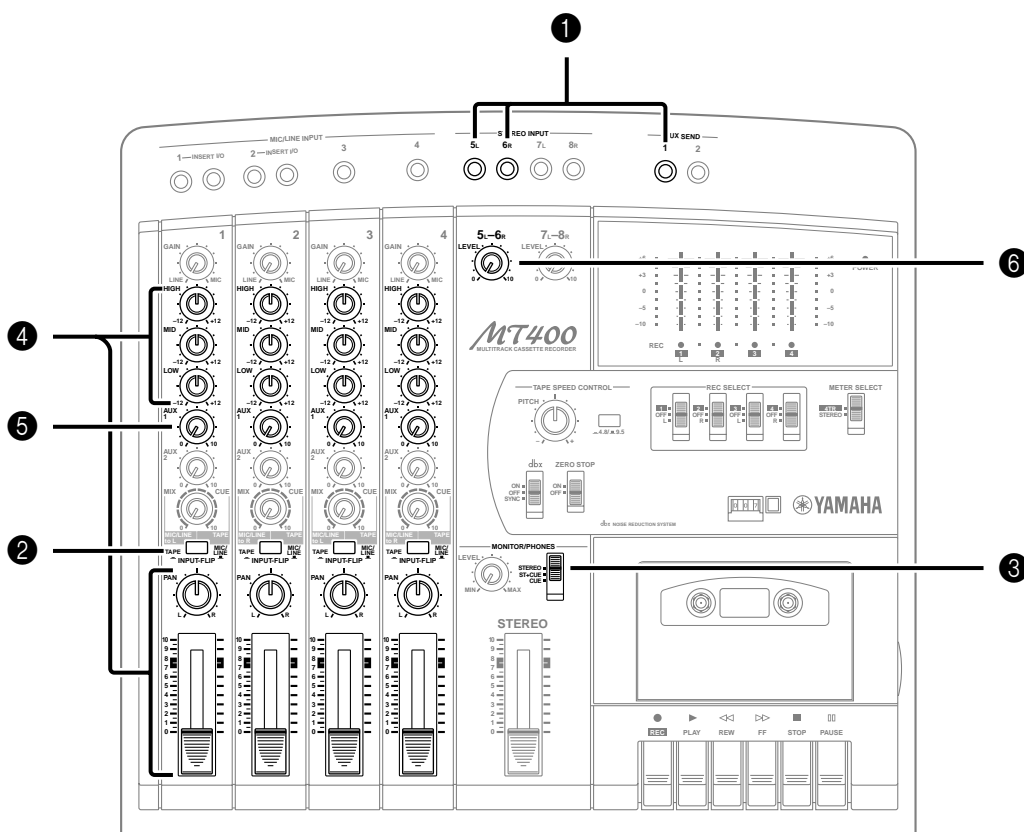

- 1 Connect AUX SEND 1 to the input of an effects processor, and connect the outputs of the effects processor to STEREO INPUT 5L/6R. Set the effects processor so that it will output only the processed signal.
- 2 Set the [INPUT-FLIP] switches on Input Channels 1–4 to “TAPE (

MT400—Owner's Manual

Punch In/Out Recording

This section explains MT400 punch in/out recording techniques. The punch in/out function allows you to re-record specific sections of a track. You can correct mistakes by starting to record your performance at a certain point (punch in) and stopping the recording (punch out). The MT400 allows you to perform punch in/outs using the [REC SELECT] switch or an optional footswitch, the FC5.

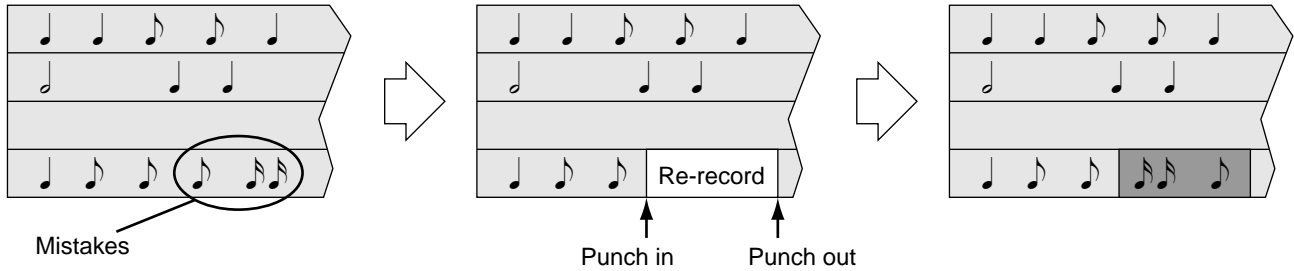

Punch in/out

Using the REC SELECT switch

Using the [REC SELECT] switch on the MT400 is the simplest way to punch in/out record. This section explains how to punch record a sound source connected to MIC/LINE INPUT 4 in Track 4.

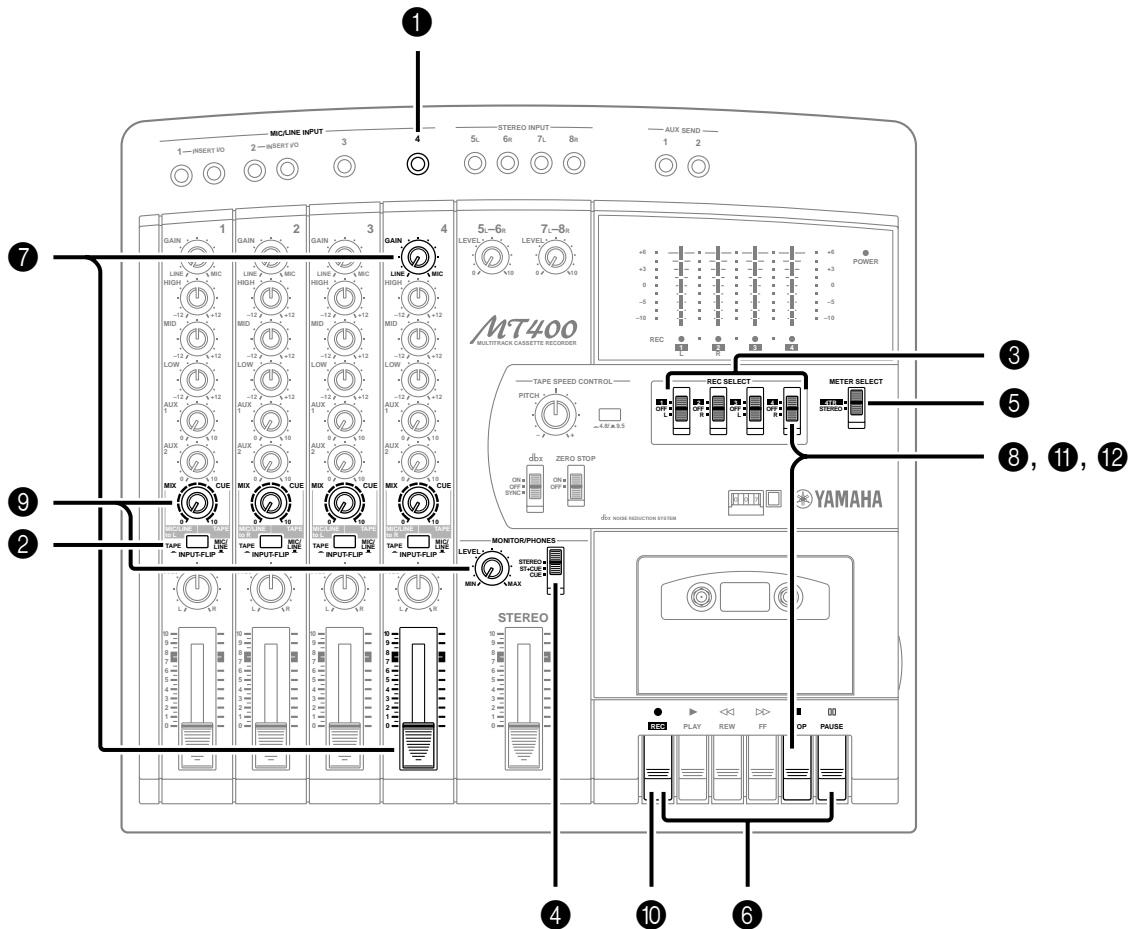

- ① Connect a sound source to MIC/LINE 4.
- ② Set the [INPUT-FLIP] switches on Input Channels 1–4 to “MIC/LINE (
 - ⑩ Locate a position before the point at which you want to punch in, and press the **REC** button.

Playback starts but recording does not start since all the [REC SELECT] switches are set to “OFF”.

- ⑪ At the point where you want to punch in, set the [REC SELECT] switch to “ 

Recording starts as soon as you set the [REC SELECT] switch to “ 
 - ⑫ At the point where you want to punch out, set the [REC SELECT] switch on Track 4 to “OFF”, and press the [STOP] button.

Recording stops as soon as you set the [REC SELECT] switch on Track 4 to “OFF”. You will hear the existing sound playback via the CUE control on Input Channel 4.

Note: Pressing the [STOP] button to stop recording instead of setting the [REC SELECT] switch to “OFF” may introduce noise into the recording. Be sure to use the [REC SELECT] switch to stop recording first, then press the [STOP] button.

Using a Footswitch

Punch in/out can be performed by connecting an optional footswitch, the FC5, to the PUNCH IN/OUT jack on the front panel of the MT400. This technique leaves your hands free, and is useful if you play an instrument and operate the MT400 at the same time for punch in/out recording. This section explains how to punch in a sound source connected to MIC/LINE 4 onto Track 4.

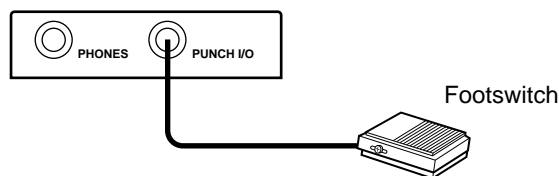

Connecting a footswitch

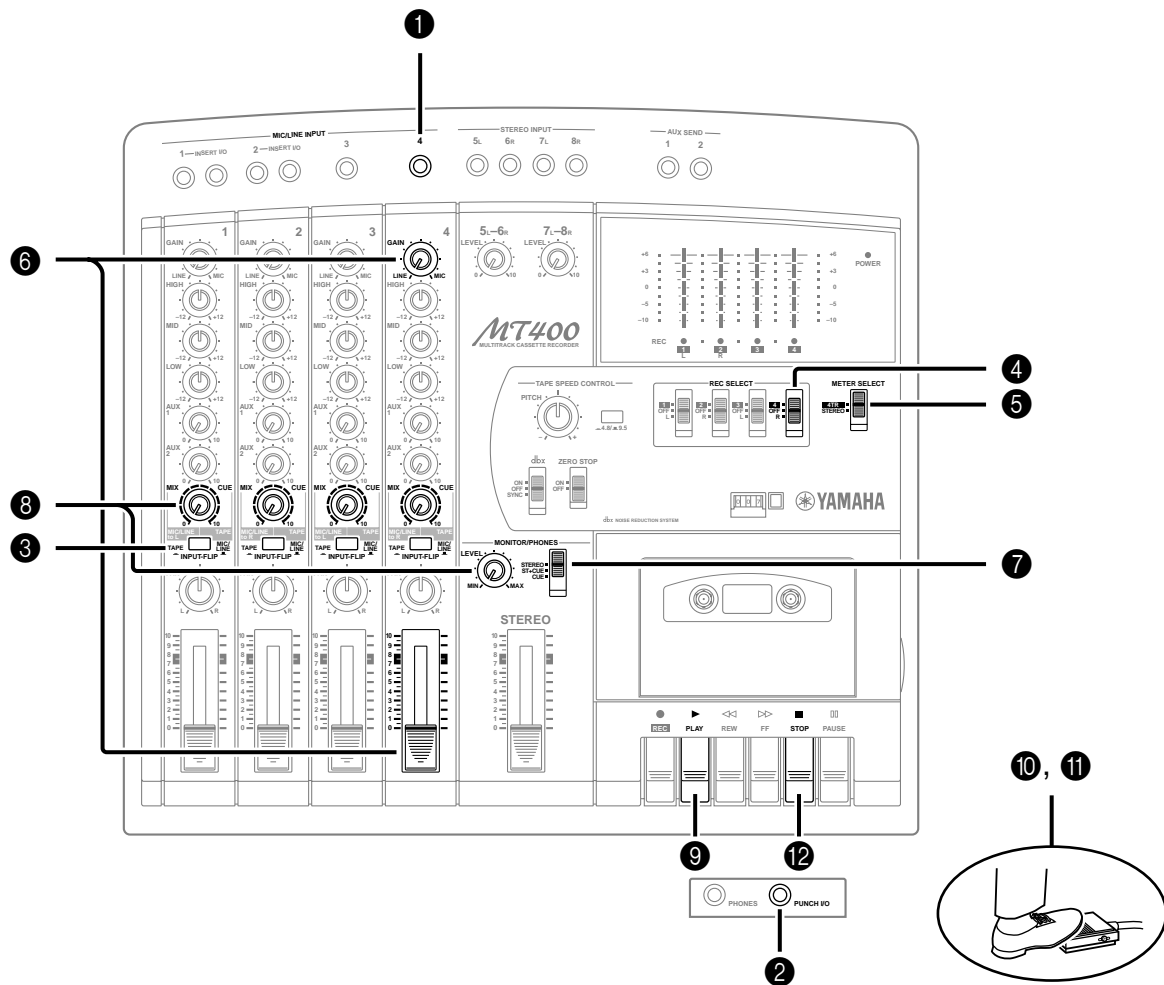

- 1 Connect a sound source to punch in to MIC/LINE 4.
 - 2 Connect a footswitch to the PUNCH IN/OUT jack.
 - 3 Set the [INPUT-FLIP] switches on Input Channels 1–4 to “MIC/LINE ()”.
 - 4 Set the [REC SELECT] switch on Tracks 4 to “**4**”.
- The Track 4 REC SELECT indicator flashes.
- 5 Set the [METER SELECT] switch to “**4TR**”.
 - 6 While watching the level meter, use the GAIN control and the fader on Input Channel 4 to adjust the input level of the sound source.
 - 7 Set the monitor select switch to “CUE”.
 - 8 Start playing the tape and use the CUE controls on Input Channels 1–4 and the MONITOR LEVEL control to adjust the monitoring level.

- 9 Locate a position before the point at which you want to punch in, and press the [PLAY] button.
- Playback on Tracks 1–4 starts.

Note: Punch in/out recording with a footswitch does not use the **REC** button. If you press the **REC** button at this point accidentally, recording will start immediately.

- 10 At the point where you want to punch in, press the footswitch once and start playing the sound source.
- Recording starts as soon as you step on the footswitch. You will hear the new sound play back instead of the existing sound.
- 11 At the point where you want to punch out, press the footswitch again.
- Recording stops as soon as you step on the footswitch, and you will hear the existing sound playback via the CUE control on Input Channel 4.
- 12 Press the [STOP] button to stop playback.

MIDI Synchronization

The MT400 is ideal for recording vocal, guitar, and other acoustic sounds and can easily be integrated into a MIDI system that includes a MIDI sequencer or sequencer software on a computer. This section describes how to synchronize the MT400 to a MIDI sequencer.

Synchronizing the MT400 with a MIDI Sequencer

To use the MT400 in a synchronized MIDI system, you must record a “SYNC” signal onto Track 4 of the MT400 before recording anything else. (Always use Track 4 to record a SYNC signal.) A SYNC signal is timing information in the form of an audio signal, which is referenced by a MIDI sequencer for operation. You only need to record this SYNC signal once on Track 4 of the MT400. During playback, the SYNC signal is output from the MT400 and sent to a MIDI sequencer, which reads the SYNC signal and plays back in synchronization with the MT400. When the MT400 is stopped, the MIDI sequencer stops, too. In this way, the MT400 works as the master control device in a synchronized MIDI system.

Note: You can still use the transport controls on the MIDI sequencer, but only the MIDI sequencer will respond.

There are many applications in the synchronization system using the MT400 and a MIDI sequencer. A typical application is to record acoustic sounds, such as vocal and guitar, to the MT400 tracks, and record other part by playing MIDI performance data on the connected MIDI sequencer. More precisely, you may record vocal or guitar on the MT400 tracks while listening to the MIDI performance data, then mix down Tracks 1–3 sounds with MIDI sound sources. (You cannot use Track 4 for recording since it is dedicated to the SYNC signal.)

SYNC Signal Formats

There are two major formats of SYNC signal: SMPTE timecode and FSK. The main difference between these two formats is that FSK contains only clock information based on the song tempo whereas SMPTE timecode contains both clock and position information that represents absolute time. This means that with SMPTE timecode you can start playback on the MT400 at any point and the MIDI sequencer will play back in synchronization. With FSK, however, you must always rewind the tape and start playback on the MT400 at the beginning of the SYNC signal for the MIDI sequencer to synchronize correctly. Although, these days something called “smart FSK”, which contains both clock and position information, is available, allowing playback to start from any position within a song.

To use SMPTE timecode, you need a device called an “MTC/SMPTE converter”. This device converts MTC output from a MIDI sequencer (MIDI timecode; absolute time information of the sequencer) into SMPTE timecode (audio signal). Some MIDI interfaces for computers have this feature built-in.

To use FSK, you need a device called a “MIDI/FSK converter”. This device converts MIDI Clock output from a sequencer (clock information of the sequencer) into FSK (audio signal). Some MIDI/FSK converters support “smart FSK”.

These devices convert MTC or MIDI Clock signals into signals that can be recorded onto a tape. During playback, the same device is used to convert the SMPTE timecode or FSK signal (audio signal) back into MTC or MIDI Clock signals.

Connecting the MT400 to a MIDI System

FSK/MIDI system

In this system, an FSK/MIDI converter is used to generate the FSK signal that is recorded onto Track 4 of the MT400. During playback, the FSK signal is output from SYNC OUT (dedicated Track 4 output) and converted to a MIDI Clock signal. When the rhythm machine and the synthesizer workstation with onboard sequencer receive the MIDI Clock signal, they both playback in synchronization.

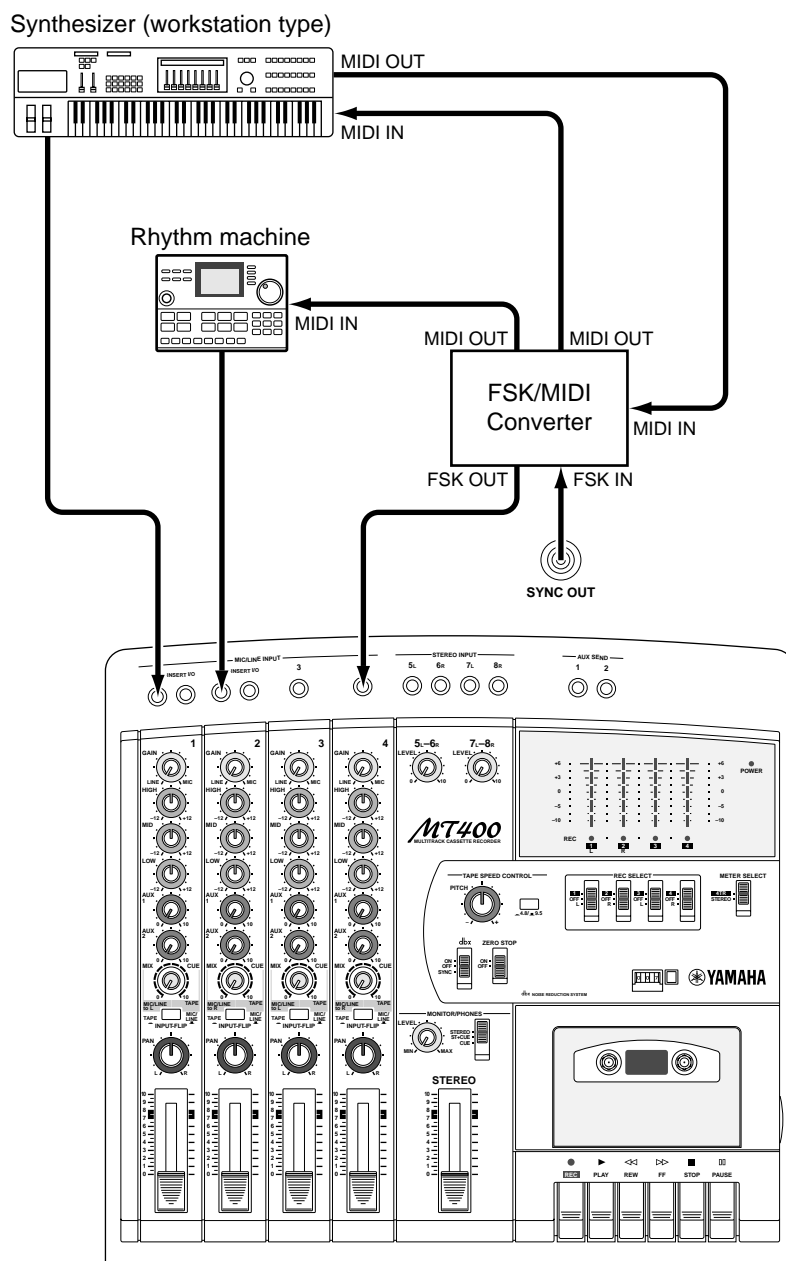

SMPTE/MTC system

In this system, a SMPTE/MIDI converter is used to generate the SMPTE timecode that is recorded onto Track 4 of the MT400. During playback, the SMPTE timecode is output from SYNC OUT (dedicated Track 4 output) and converted to a MIDI timecode.

An example below uses a MIDI interface that has two MIDI IN/OUT jacks. If you have only one pair of MIDI IN/OUT jacks, change the connection as described below.

- **Creating sequence data**
Connect MIDI IN of the MIDI interface to MIDI OUT of the MIDI keyboard.
Connect MIDI OUT of the MIDI interface to MIDI IN of the MIDI tone generator or synthesizer.
- **Recording a SYNC signal**
Connect MIDI OUT of the MIDI interface to MIDI IN of the SMPTE/MTC converter.
- **Operating in synchronization**
Connect MIDI IN of the MIDI interface to MIDI OUT of the SMPTE/MTC converter.
Connect MIDI OUT of the MIDI interface to MIDI IN of the MIDI tone generator or synthesizer.

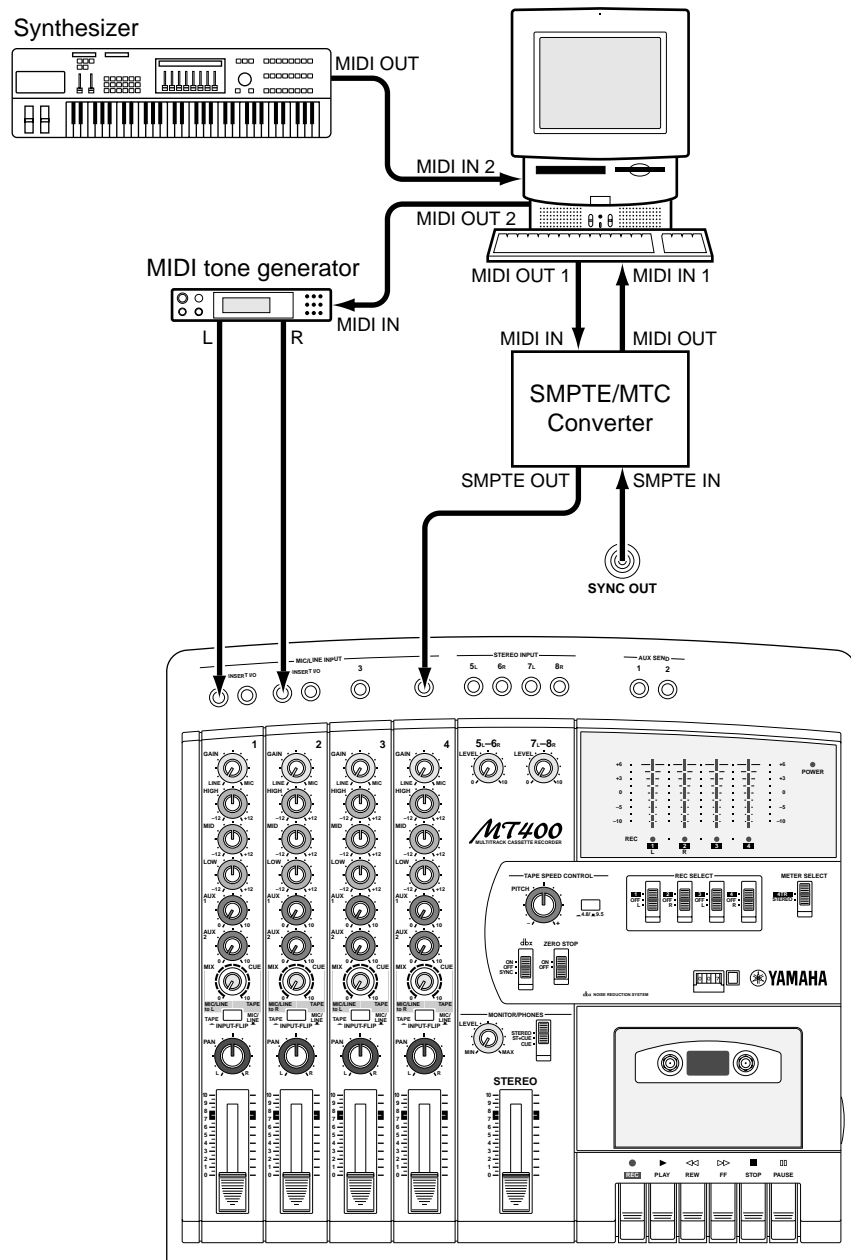

Recording a SYNC Signal on the Tape

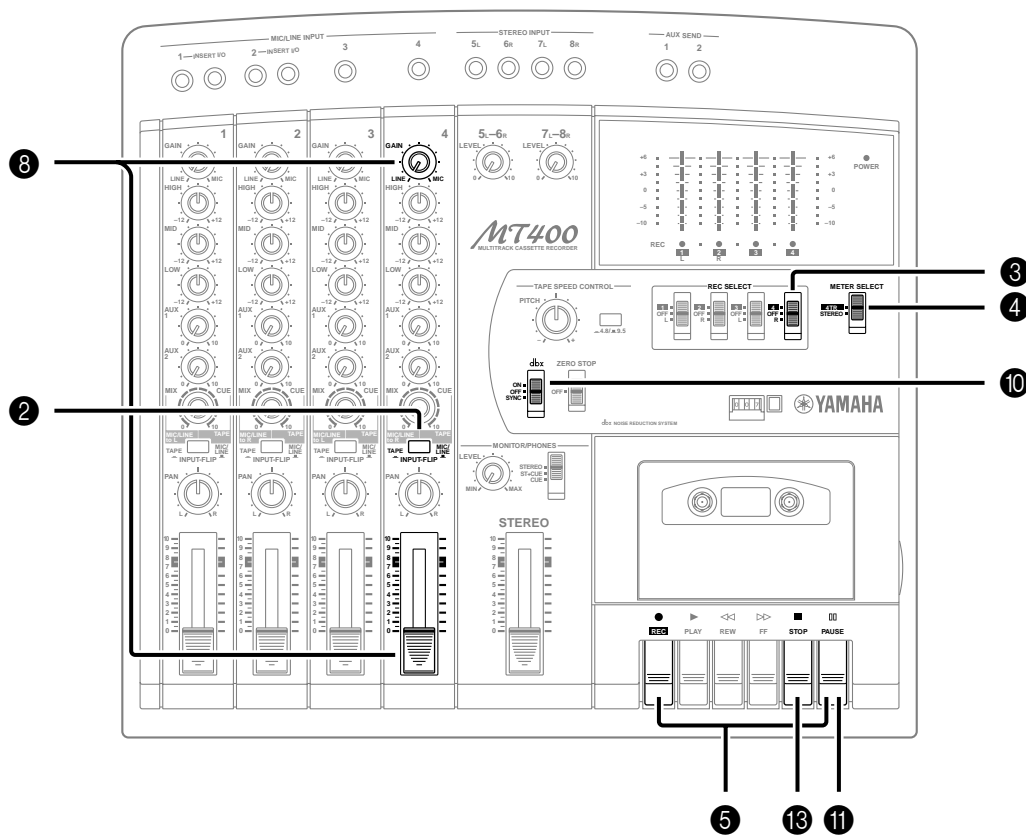

- 1 Connect the MT400 to the FSK/MIDI converter or the SMPTE/MTC converter as shown in the diagrams on pages 38 and 39.
- 2 Set the [INPUT-FLIP] switch on Input Channel 4 to "MIC/LINE ()".
- 3 Set the [REC SELECT] switch on Track 4 to "4".
The Track 4 REC SELECT indicator flashes. A signal output from the converter is routed to Track 4 via the MIC/LINE INPUT 4 of the MT400.
- 4 Set the [METER SELECT] switch to "4TR".
- 5 Press the [PAUSE] button, then the **REC** button.
- 6 Prepare the MIDI sequencer and FSK/MIDI or SMPTE/MIDI converter for SYNC signal output.

- 7 Start the MIDI sequencer, or SMPTE/MTC converter.

A SYNC signal is sent from the converter to Track 4 via Input Channel 4.

- 8 While checking the level meter, use the GAIN control and the fader on Input Channel 4 to set the level of the SYNC signal.

At this time, set all the EQ controls to midway around noon (flat).

Note: If the level of the SYNC signal is too high, the signal may sometimes leak to an adjacent track. If the level is too low, you may not be able to achieve correct synchronization. Set the level so that the 0 dB segment of the level meter lights up.

- 9 Stop the MIDI sequencer, or the SMPTE/MTC converter.
- 10 Set the [dbx] switch to "SYNC".
The dbx reduction system is cancelled only on the sync track (Track 4).
- 11 Press the [PAUSE] button to start recording.
The Track 4 REC SELECT indicator lights up continuously.
- 12 After about five seconds, start the MIDI sequencer from the beginning.
The SYNC signal is recorded onto Track 4.
- 13 Wait a while after the MIDI sequencer reaches the end of song, then stop the MIDI sequencer. Press the [STOP] button on the MT400 to stop recording.
It is good idea to record the SYNC signal beyond the end of the song. This enables you to easily extend the song. You cannot extend the SYNC signal once it has been recorded.

Synchronized Recording

With the SYNC signal recorded on Track 4 of the MT400, you can record vocal, guitar, and other instruments on Track 1–3 while listening to the MIDI sequencer. This section explains how to record your performance on Track 1 while listening to the MIDI sound source connected to STEREO INPUTs 5 and 6.

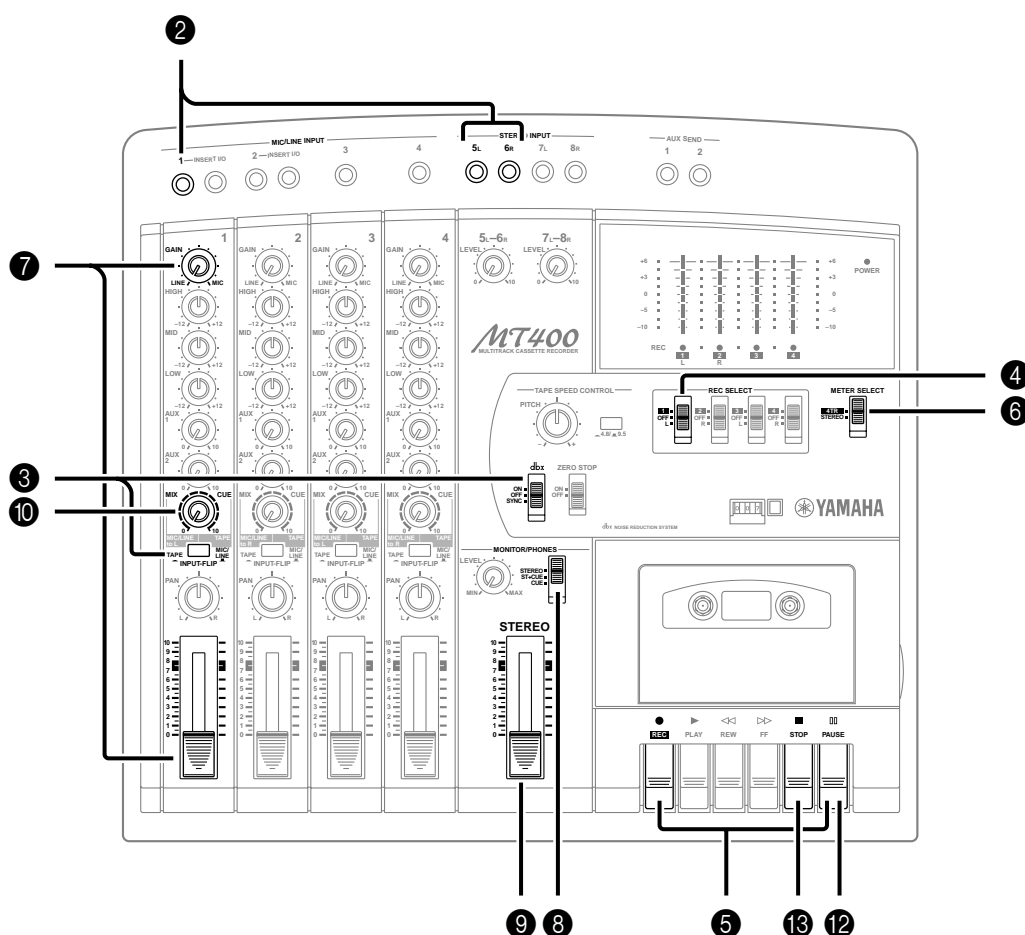

- ❶ Connect the MT400 to the FSK/MIDI converter or the SMPTE/MTC converter as shown in the diagrams on pages 38 and 39.
- ❷ Connect the sound source you wish to record on Track 1 to MIC/LINE INPUT 1, and connect the MIDI sound source to STEREO INPUTs 5L and 6R.
- ❸ Set the [INPUT-FLIP] switch on Input Channel 1 to "MIC/LINE (■)". Make sure that the [dbx] switch is set to "SYNC".

Note: The SYNC OUT jack always outputs Track 4 signal, regardless of the settings for Input Channel 4.

- ❹ Set the [REC SELECT] switch on Track 1 to "1".
The Track 1 REC SELECT indicator flashes.
- ❺ Press the [PAUSE] button, then the **REC** button.
- ❻ Set the [METER SELECT] switch to "4TR".
The level meter shows the input level of the recording source for Track 1.
- ❼ While checking the level meter, use the GAIN control and the fader on Input Channel 1 to set the recording level.
- ❽ Set the monitor select switch to "ST+CUE".
To make a recording while synchronizing the MIDI sequencer, you need to monitor both the MIDI sound source signals (routed from STEREO INPUTs 5 and 6 to the Stereo bus) and the track recording signal (routed from Track 1 to the CUE bus). To do this, set the monitor select switch to "ST+CUE".
- ❾ While playing the MIDI sequencer, use the STEREO fader and the volume control of the MIDI tone generator to adjust the monitoring level of the MIDI sound source.

Note: MIDI sound source signal sent to the Stereo bus is not recorded on the tracks.

- ❿ Use the CUE control on Input Channel 1 to adjust the monitoring level of the sound recorded on Track 1.
- ⓫ Set up the MIDI sequencer so that it will lock to external MTC or MIDI Clock.

- ⓬ Press the [PAUSE] button to start recording. The MIDI sequencer should synchronize and play along with the MT400. You can now record sound to Track 1, while monitoring the MIDI performance data (in the Stereo bus) and recording sound on Track 1 (in the CUE bus).
- ⓭ Press the [STOP] button to stop recording. Record Tracks 2 and 3 in the same way.

Synchronized Mixdown

After synchronized recording with the MT400 and the MIDI sequencer, you can mix the tape tracks with the MIDI performance data and record them onto the master recorder. This section explains how to mix tape Tracks 1–3 with the MIDI sound sources connected at MIC/LINE INPUTs 1–4.

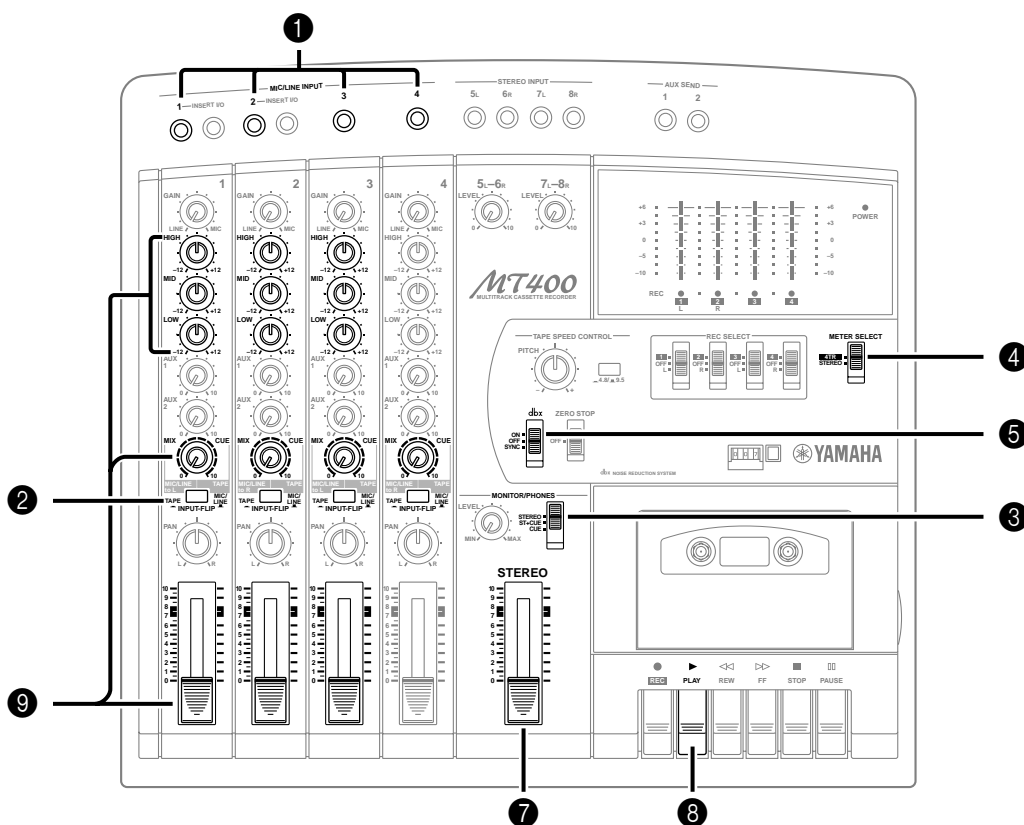

- 1 Connect the MIDI sound sources to MIC/LINE INPUTs 1–4.

You may use STEREO INPUTs 5L/6R or 7L/8R, if necessary.

- 2 Set the [INPUT-FLIP] switch on Input Channels 1–4 to “TAPE (—)”.

Tape Tracks 1–4 are sent to the STEREO bus via the input channels. Input signals at MIC/LINE INPUTs 1 and 3 and STEREO INPUT 5L or 7L are routed to the L channel of the Stereo bus, and input signals at MIC/LINE INPUTs 2 and 4 and STEREO INPUT 6R or 8R are routed to the R channel of the Stereo bus.

- 3 Set the monitor select switch to “STEREO”.

- 4 Set the [METER SELECT] switch to “STEREO”.

- 5 Make sure that the [dbx] switch is set to “SYNC”.

- 6 Set up the MIDI sequencer so that it will lock to external MTC or MIDI Clock.

- 7 Raise the STEREO fader to the 7–8 mark.

- 8 Press the [PLAY] button to play back the tape. The MIDI sequencer should synchronize and the MIDI performance data should start playing along with the MT400.

- 9 Use the faders, PAN controls, and EQ controls on Input Channels 1–3 to adjust the volume level, pan, and tonal quality of Tracks 1–3. Use the CUE controls on Input Channels 1–4 to adjust the volume level of the MIDI performance data.

At this time, make sure that the fader on Input Channel 4 is lowered to the 0 mark.



- 10 Start recording on the master recorder, and start playback from the beginning of the song on the MT400.

After recording, play the master recorder to listen to the mixdown.

Appendix

Troubleshooting

If you are having difficulty operating the MT400 or it does not seem to work as expected, look up the symptoms in the following table and note the offered advice.

Symptom	Advice
MT400 cannot be turned on.	Make sure the AC adapter is connected to a suitable AC wall outlet securely and plugged into the DC 12V connector at the rear of the MT400.
	Make sure that a correct AC adapter is being used.
	Make sure that the MT400 POWER switch is set to the ON position.
Cannot listen to a connected music source.	Make sure that the [INPUT-FLIP] switches and the monitor select switch are set to the appropriate positions. When an [INPUT-FLIP] switch is set to "MIC/LINE ()", raise the corresponding input channel fader and the STEREO fader, and set the monitor select switch to "STEREO" or "ST+CUE". When an [INPUT-FLIP] switch is set to "TAPE ()", raise the corresponding channel CUE control and the STEREO fader, and set the monitor select switch to "STEREO" or "ST+CUE".
Cannot push in the REC button.	Make sure that tape's write-protect tabs are intact.
Cannot record.	Make sure that the [REC SELECT] switch is not set to "OFF".
	Make sure that you have assigned the signal that you want to record to the track. Use the CUE control to see if the signal is actually being sent to the track.
The level meters do not indicate signal levels.	Make sure that the [METER SELECT] switch is set correctly.
	Make sure that the recording track is in recording pause mode.
Recordings are noisy.	Use the dbx noise reduction.
	Make sure that the recording level is set correctly. Too low a signal level will cause the tape hiss to be more noticeable.
Recordings are distorted.	Make sure that the recording level is set correctly. Too high a signal level will cause distortion.
Recordings sound dull. Abnormal tape hiss. Wow and flutter. Fluctuating output level.	Clean the record-play head and other parts of the tape transport. Demagnetize the record-play head.
Recordings play back at a lower (or higher) pitch by one octave.	Use the same tape speed as for recording.
Cannot send a channel signal to the AUX SEND.	In addition to turning up the AUX control, you must also raise the channel fader. This is because the AUX SEND signal is source post-fader (i.e., after the fader).
MIDI sequencer does not synchronize to the MT400.	Make sure that the FSK/MIDI or SMPTE/MIDI converter is set to convert the recorded SYNC signal into MIDI Clock or MTC.
	Make sure that your MIDI sequencer is set to synchronize to an external MIDI Clock or MTC. Refer to the MIDI sequencer's user manual.

Maintaining the MT400

The MT400 requires regular maintenance to remain in top working condition for a long period of time.

Cleaning the Record-Play Head, Erase Head, Capstan, and Pinch Roller

As the tape passes over the record-play head, a tiny amount of magnetized particles and dust is left on the head. If you don't clean the head, these particles can build up to the point where the tape surface may be scratched or high-range sounds may become dull. Therefore, you should clean the record-play head at regular intervals. Also, magnetic particles and dust left on the capstan, pinch roller, and other parts may cause wow & flutter characteristics to deteriorate, resulting in skipped sounds.

To clean the record-play head, erase head, and capstan, use a commercial head-cleaning kit. These kits usually contain specially-made cotton swabs and an isopropyl alcohol-based cleaning solution, and are available at audio and electronics shops. Follow the directions on the kit, carefully wiping the record-play head, capstan, and erase head with a swab soaked in cleaning solution.

It is best to clean the pinch roller with a non-alcohol based rubber cleaning solution. Alcohol tends to dry out and corrode the rubber part of the roller.

It is recommended that you clean the record-play head, capstan, pinch roller, and erase head before each new recording session or after every 10 hours of use for optimum recording. Dirty heads may distort the sound or induce noise. In the worst case, you may not be able to play or record.

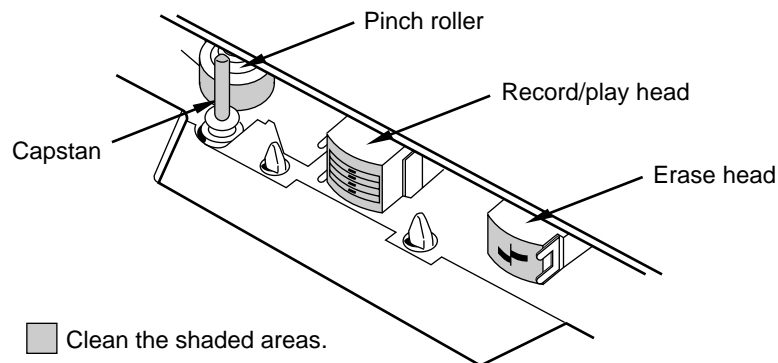

Demagnetizing the Record-Play Head

As the tape passes over the record-play head, it imparts a tiny amount of magnetism to the head. You should demagnetize the record-play head at regular intervals using a commercial tape head demagnetizer, which are available at most audio and electronics shops. Follow the directions for the demagnetizer carefully. Misuse can damage the record-play head. Also, do not place audio tapes close to the demagnetizer while you are using it. The demagnetizer emits a strong magnetic field and can erase all information stored on the tapes. Be sure to store the tapes far from the demagnetizer.

It is recommended that you demagnetize the record-play head after 10 hours of use. Clean the heads and other parts and demagnetize the record-play head optimize conditions before an important recording session.

Specifications

Tape Transport

Tape Type	C46–90 cassette tapes (Type II)
Track Configuration	4-track/4-channel, One-way Record-Play
Tape Heads	4-track Record-Play, Hard Permalloy x 1, 4-track Erase, Ferrite x1
Motor	DC servo motor x1
Tape Speed	4.8 cm/s, 9.5 cm/s
Pitch Control	Approximately $\pm 10\%$
Wow & Flutter	0.12% WRMS (9.5 cm/s)
Rewind Time	Approximately 120 seconds for a C60 tape

Mixer

Frequency Response	20 Hz–20 kHz, $+1/-4$ dB, MIC IN—STEREO OUT LINE IN—MONITOR OUT
S/N Ratio (at rated input & output levels)	65 dB/IHF-A, MIC IN—STEREO OUT (GAIN TRIM MAX) 70 dB/IHF-A, LINE IN—STEREO OUT (GAIN TRIM MIN)
EQ	LOW/Shelving Basic frequency: 80 Hz, Range: ± 12 dB MID/Peaking Basic frequency: 1 kHz, Range: ± 12 dB HIGH/Shelving Basic frequency: 12 kHz, Range: ± 12 dB

Recorder

Overall Frequency Response	50 Hz–14 kHz, $+3/-5$ dB (9.5 cm/s, NR OUT)
Overall S/N Ratio	80 dB/IHF-A (NR IN) [at 3% distortion level]
Overall Distortion	2.0% (400 Hz, -10 dB)
Erase Rate	55 dB (1 kHz, 0 dB, BPF)
Noise Reduction	dbx TYPE II

Connections

# of I/Os	MIC/LINE x4 INSERT I/O x2 STEREO IN x2 AUX SEND x2 STEREO OUT L, R x1 MONITOR OUT L, R x1 SYNC OUT x1 PHONES L, R x1
-----------	---

I/O Specifications

MIC/LINE	Input Impedance: 10 k Ω Rated Input Level: -10 to -50 dB (CH fader at rated levels) Minimum Input Level: -56 dB (Gain trim max. CH fader max)
INSERT IN CH 1, 2	Input Impedance: 10 k Ω Rated Input Level: -10 dB (CH fader at rated levels) Minimum Input Level: -16 dB (CH fader max)
STEREO IN	Input Impedance: 10 k Ω Rated Input Level: -10 dB (CH fader at rated levels) Minimum Input Level: -16 dB (Volume max)
INSERT OUT CH 1, 2	Output Impedance: 100 Ω Rated Load Impedance: 10 k Ω or higher Rated Output Level: -10 dB (10 k Ω load)

STEREO OUT L, R	Output Impedance: 1 k Ω Rated Load Impedance: 10 k Ω or higher Rated Output Level: -10 dB (10 k Ω load)
AUX SEND	Output Impedance: 1 k Ω Rated Load Impedance: 10 k Ω or higher Rated Output Level: -10 dB (10 k Ω load)
MONITOR OUT	Output Impedance: 1 k Ω Rated Load Impedance: 10 k Ω or higher Rated Output Level: -10 dB (10 k Ω load)
SYNC OUT	Output Impedance: 1 k Ω Rated Load Impedance: 10 k Ω or higher Rated Output Level: -10 dB (10 k Ω load)
PHONES (STEREO)	Rated Load Impedance: 8 to 40 Ω Rated Output Level: 30 mW+30 mW (40 Ω load)

Control Jack

PUNCH I/O	Foot switch: FC5 (optional)
------------------	-----------------------------

General

Power Requirement	DC 12V (650 mA or higher)
Dimensions (WxHxD)	388 x 102 x 354 mm
Weight	2.8 kg
Option for UK model	AC adapter KPA4N, KPA6N

0 dB=0.775 Vrms.

Dimensions

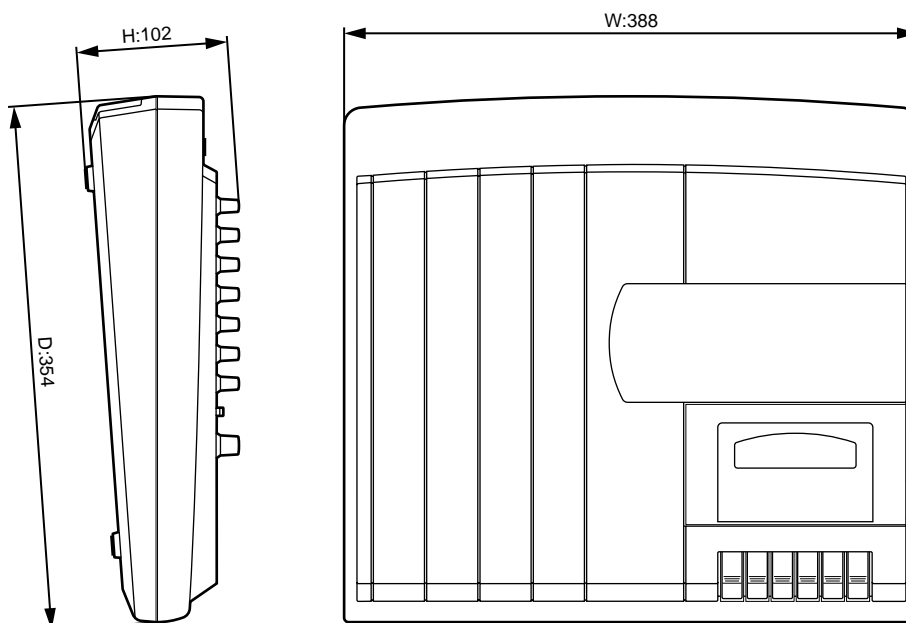

Unit: mm

Specifications and appearance are subject to change without notice.

Block Diagram

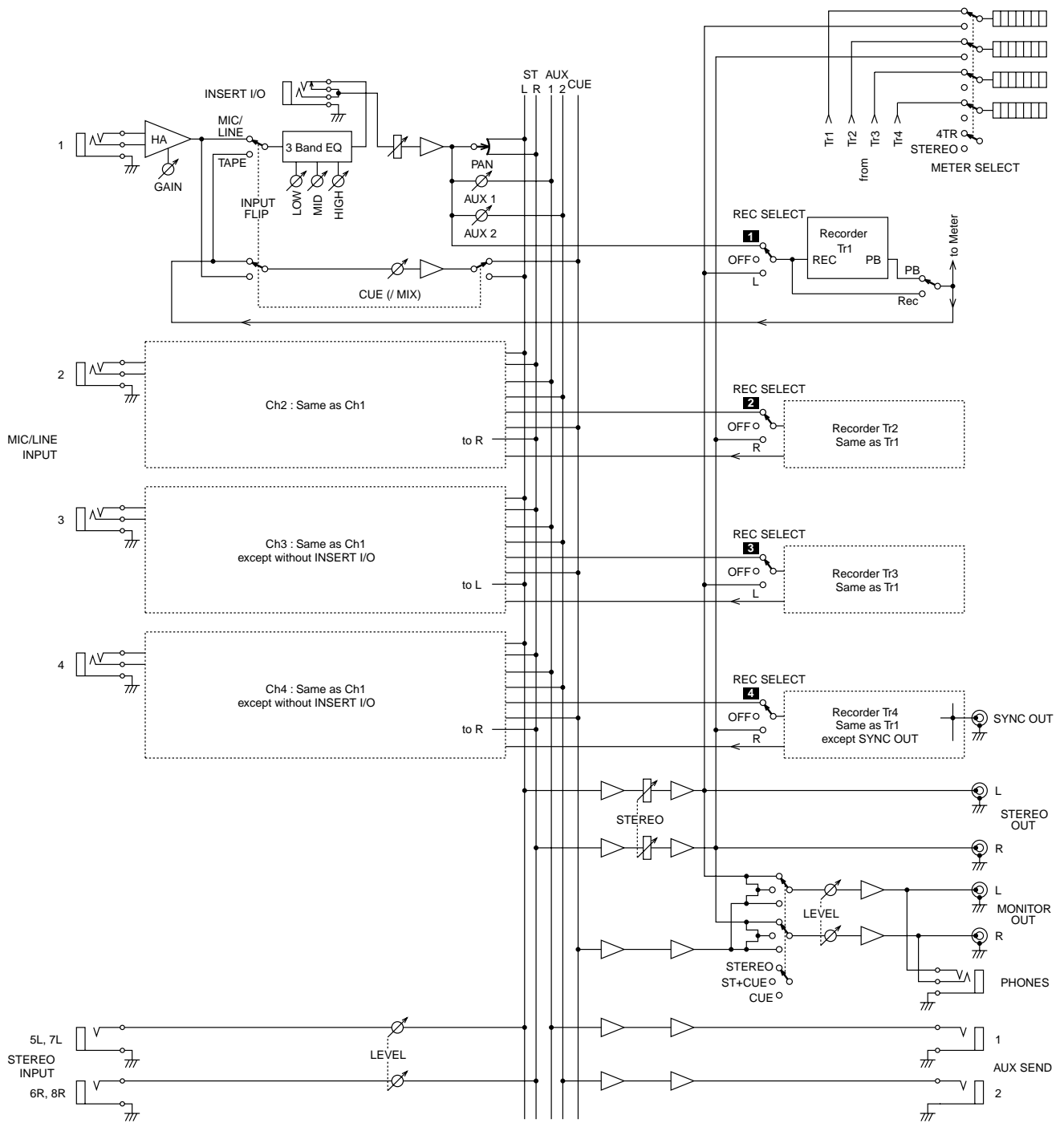

Mixer Setup

Input Source:	Input Source:	Input Source:	Input Source:	Input Source:

Track List			
1	2	3	4

Tape speed control

PITCH: 4.8 9.5

AUX 1	AUX 2
Effect	Effect

dbx

ON OFF SYNC

Session Info
Title:
Date:
Step:
Process:
Notes:

Position

Start
Stop

MT400 Tracking Sheet