

Complete and Customizable Communications Solutions

ADECIA



“SOUND” ACCELERATES BUSINESS.

With new and ever-changing communication requirements, one thing remains the same: the need for high-quality, worry-free audio for collaboration. ADECIA helps organizations overcome challenges with implementation, configuration and room acoustics by providing all components required for a successful installation - designed to work seamlessly together to reduce set up time, costs and complexities.

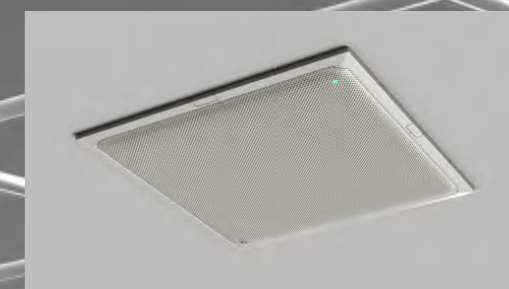

Ceiling Array Microphone

RM-CG



Remote Conference Processor

RM-CR



Intelligent L2 Network switch with PoE

SWR2311P-10G



Dante PoE powered speaker system

VXL1-16P

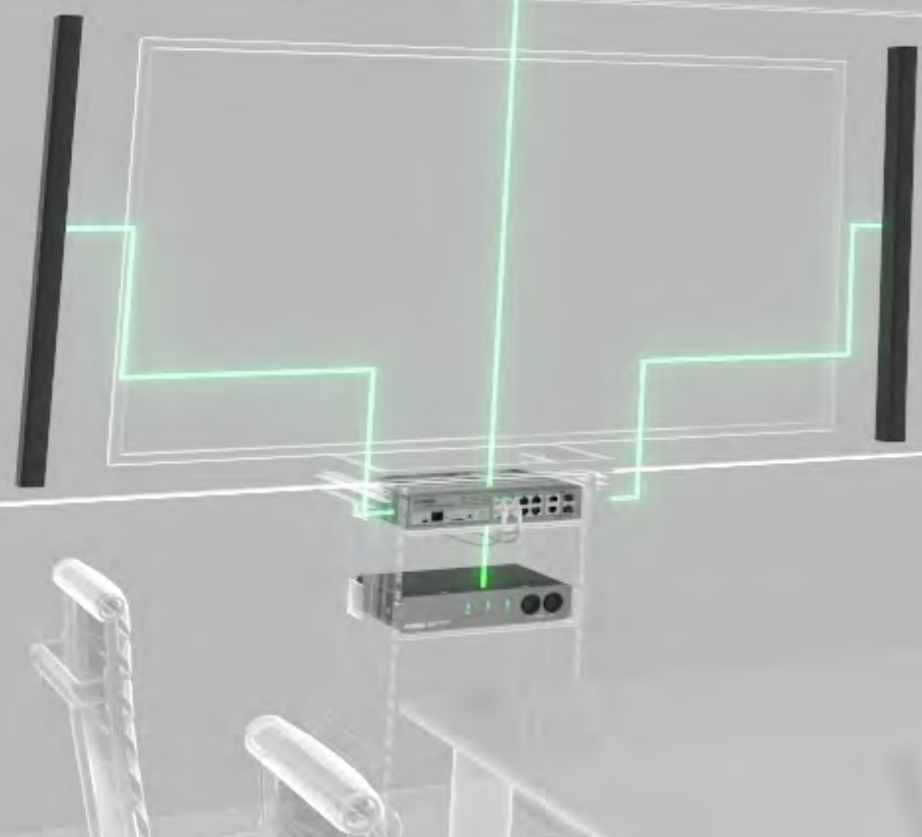



Complete Coverage from Sound Input to Output

ADECIA helps organizations overcome challenges with implementation, configuration and room acoustics by providing all components required for a successful installation - designed to work seamlessly together to reduce set up time, costs and complexities.

Reduce Time, Spend and Complexities

Audio/control signals can be transmitted with one network cable using audio network standard, "Dante", solving troublesome wiring and installation problems.

Integration into All Audio Environments

Equipped with various interfaces such as USB, Bluetooth®, SIP, and audio input/output terminals, the system allows the flexibility to use for both web conference system and telephone line conferences. Supporting Windows, macOS, iOS and Android, as well as compliance with market leading UC applications, ADECIA gives you the flexibility to customize the solution to your specific needs.

Best Audio in Shortest Time

System automatically detects all components and configures them to be optimized for the room environment, taking into consideration location of speakers and microphones, reverberation characteristics of the room, and echo behavior. Setting up a room can be as easy as following the configurator through four steps of configuration.

Capture Every Word

Dynamic multi-beam voice tracking technology supports lively discussions with multiple participants, conveying a clear audio signal from each participant to remote parties. Its unique processing functionalities that help capture the human voice over noise help provide a smooth and stress-free remote conversation experience.

System Example

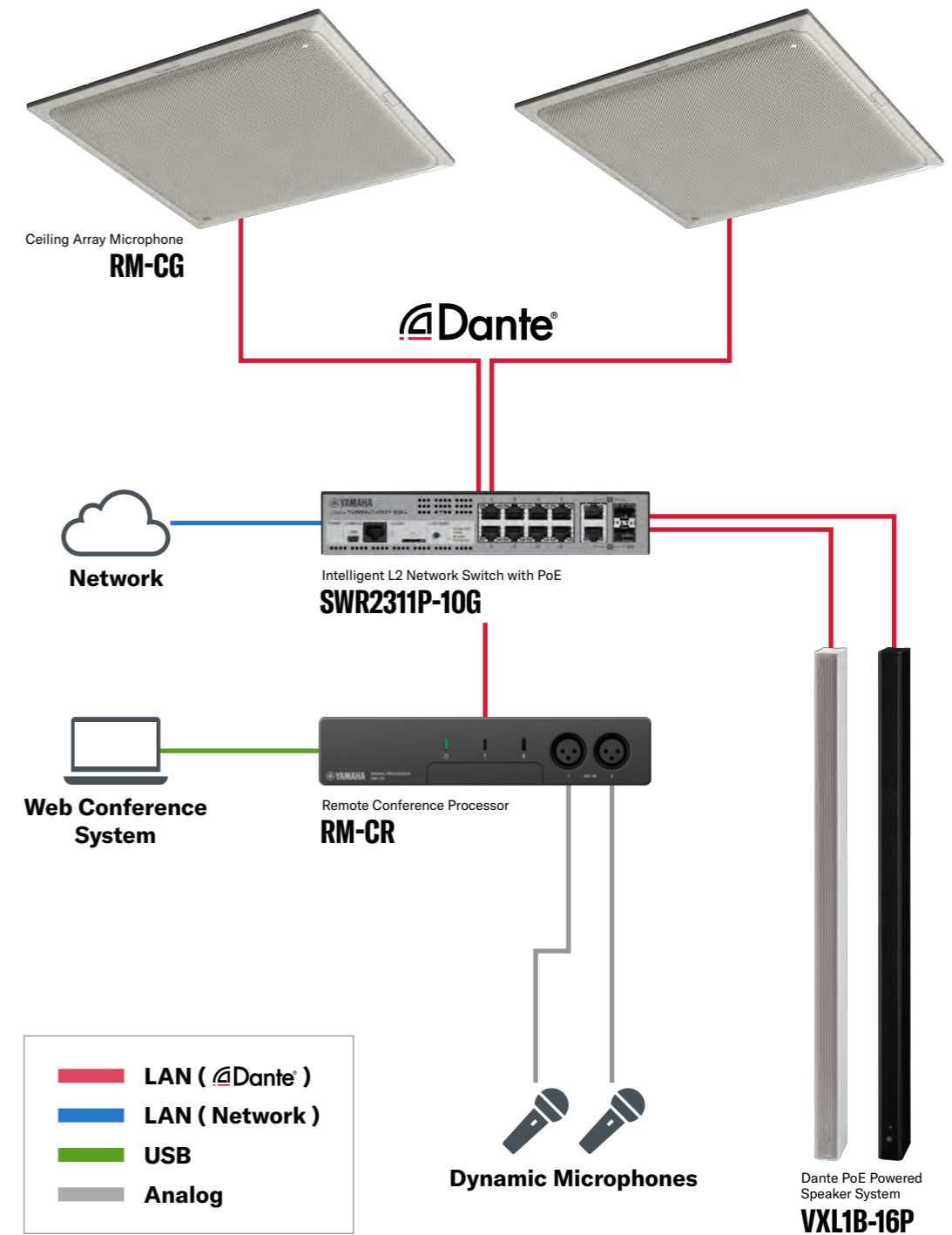

Sound Processing for High Quality Remote Conferencing Experience

Dynamic Voice Tracking

The beams constantly scan, detect and follow human voice. No fixed beams allow for flexible room layout and participant positioning.

Auto Tracking Beamforming

The four dynamic beams simultaneously track multiple people, allowing for lively conversations. With a narrow directivity of each beam, the system accurately captures speech while suppressing background noise, enabling a highly intelligible voice to the far end.

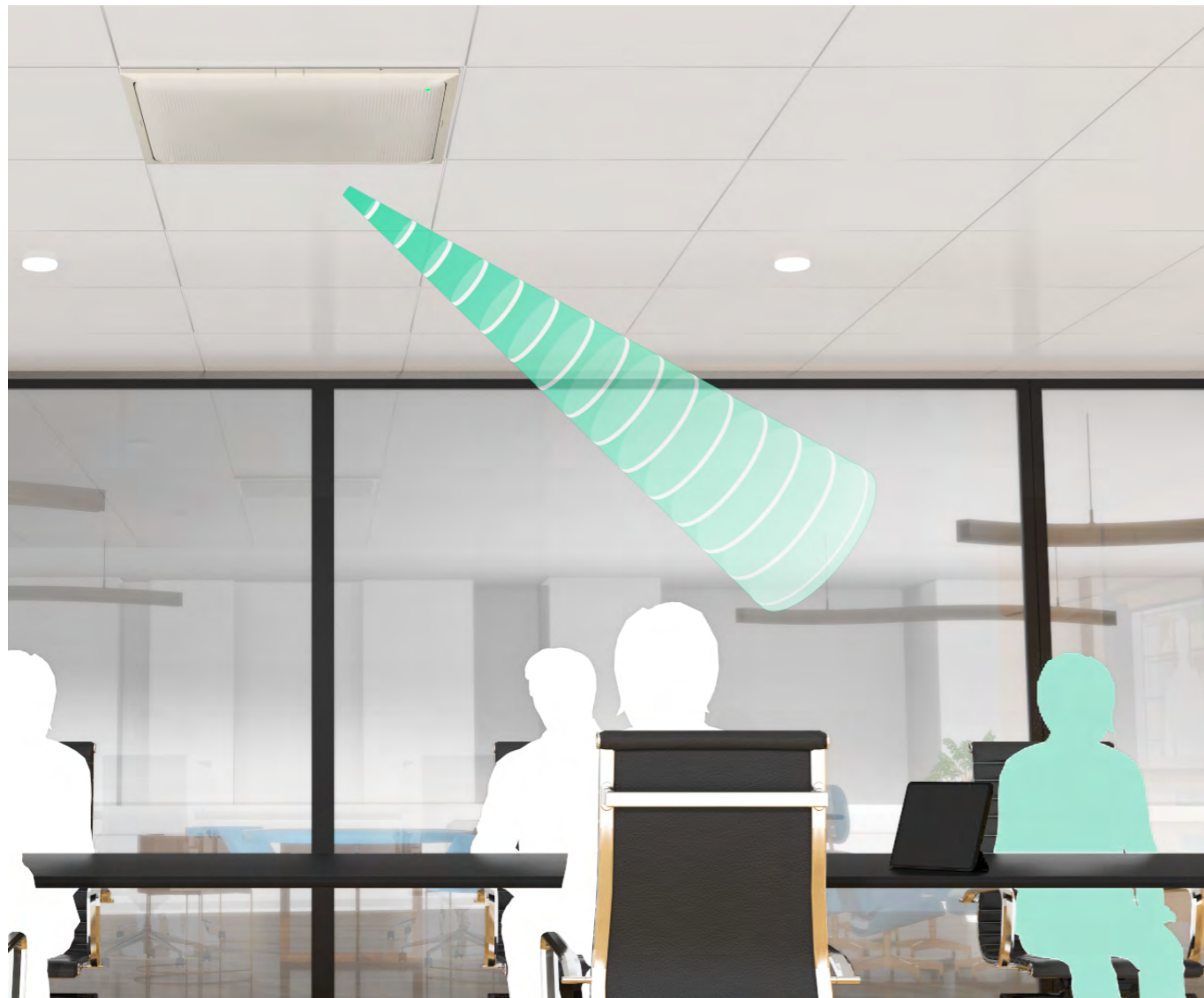

Unique Yamaha Processing Technologies

Yamaha's unique HVAD technology distinguishes the human voice vs. noise to block unneeded sound from being sent to the far-end.

1 ADAPTIVE ECHO CANCELLER

While other echo cancellers measure the room and set levels once, Yamaha's adaptive echo cancellation is constantly scanning the environment for changes to deliver an uninterrupted, echo-free audio stream.

2 AUTOMATIC GAIN CONTROL

This sound technology automatically adjusts voice levels to deliver a consistent, optimal volume level to the far-end, no matter if some voices are louder vs. weaker or closer vs. further away from the microphone. This automatic feature enables everyone to hear or be heard at an ideal level.

3 NOISE REDUCTION

When constant noise like a projector fan or air conditioner system enters the communication space, Yamaha's Noise Reduction technology removes these components to clearly convey the presenter's audio to the far-end.

4 DEREVERBERATION

Reverberation from an acoustically-poor environment can make it difficult to distinguish a clear voice signal. Dereverberation suppresses these reverb components to deliver a highly-intelligible output.

Various Mounting Methods to Best Fit Your Usage

Ceiling Array Microphone RM-CG Installation

Ceiling Mount

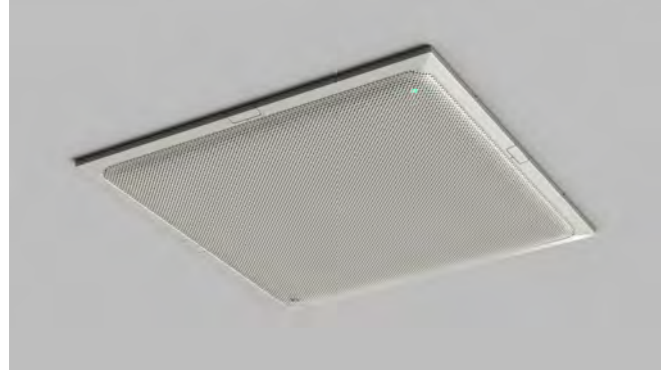

Wire Mount



Pole Mount



Remote Conference Processor RM-CR Installation

Rack Mount



Table Mount



Setup Wizard

Follow the setup wizard on your web browser and with just a few clicks it will automatically adjust the audio according to your system's audio routing and room environment.

RM-CR Quick Setup

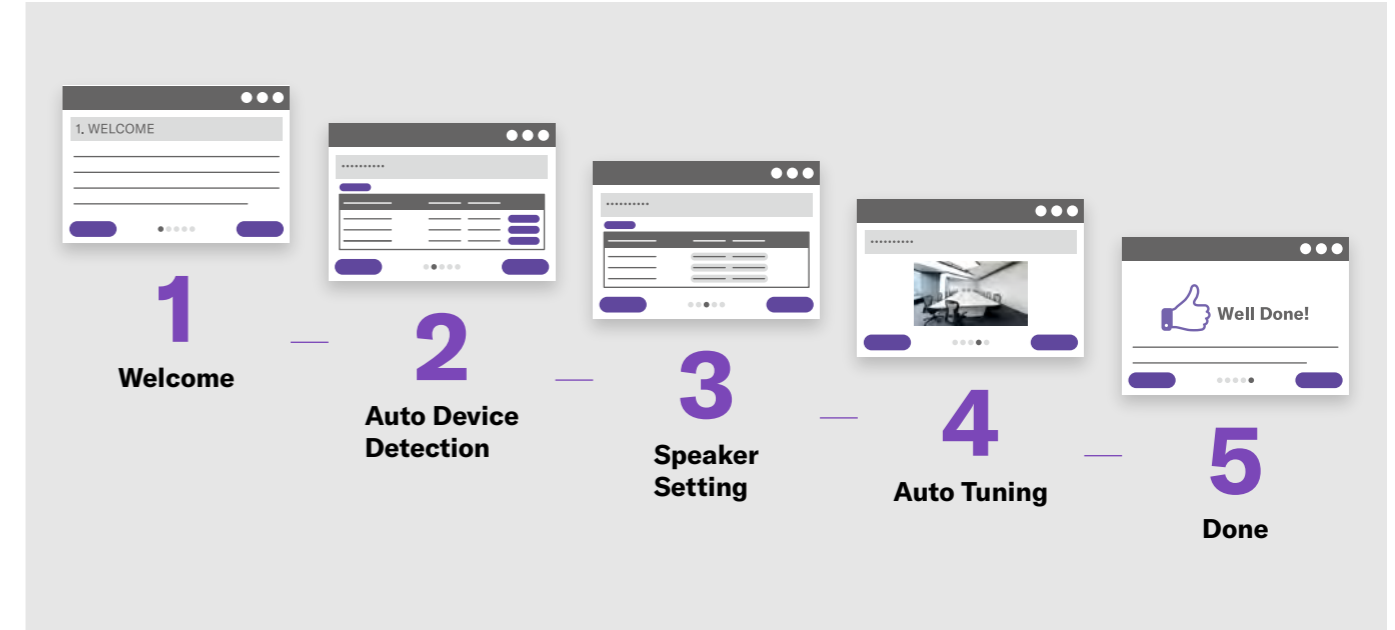

DSP Setting List

Following items are able to customize.

DSP	Settings
Adaptive Echo Canceller	Off
	Gentle
	Medium (Default)
	Strong
Noise Reduction	Off
	Gentle
	Medium (Default)
	Strong
Dereverberation	Off
	Gentle
	Medium (Default)
	Strong

DSP	Settings
AGC: Type	Off
	Soft (Default)
	Hard
AGC: Speed	Slow (Default)
	Fast
Auto Mixing	1Ch Gating
	2Ch Gainsharing (Default)
	4Ch Gainsharing
	4Ch Mixing
Beam Tracking: Speed	Fast (Default)
	Slow
Beam Tracking: Area Limitation	Disable (Default)
	Enable

Flexible Application Support



Lecture Room/Training Room/Multipurpose Room

Flexible layouts are not an issue with dynamic beams. No fixed lobes can enable discussions, seminars and training areas without the need to reprogram the system.

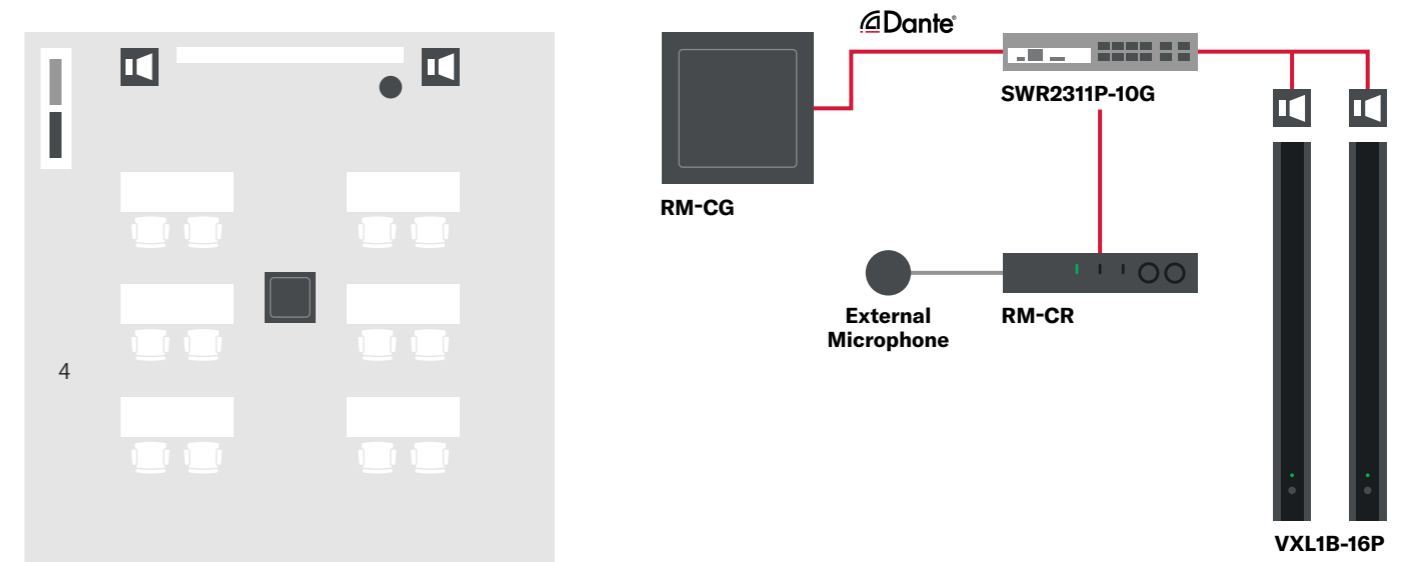

Boardroom

With a simple and sophisticated design, the unit blends into high-end spaces and enables a clean and clear table.

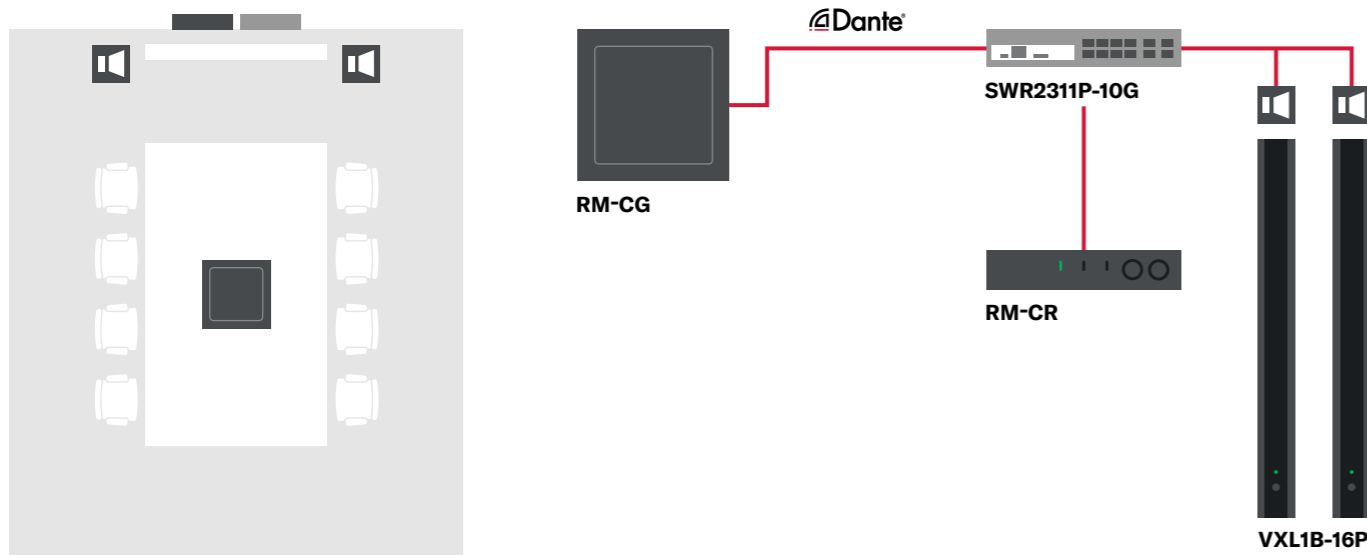

Medium-sized Conference Room

With the ability to connect two ceiling array microphones, you can expand the coverage in larger collaboration spaces to capture more people.

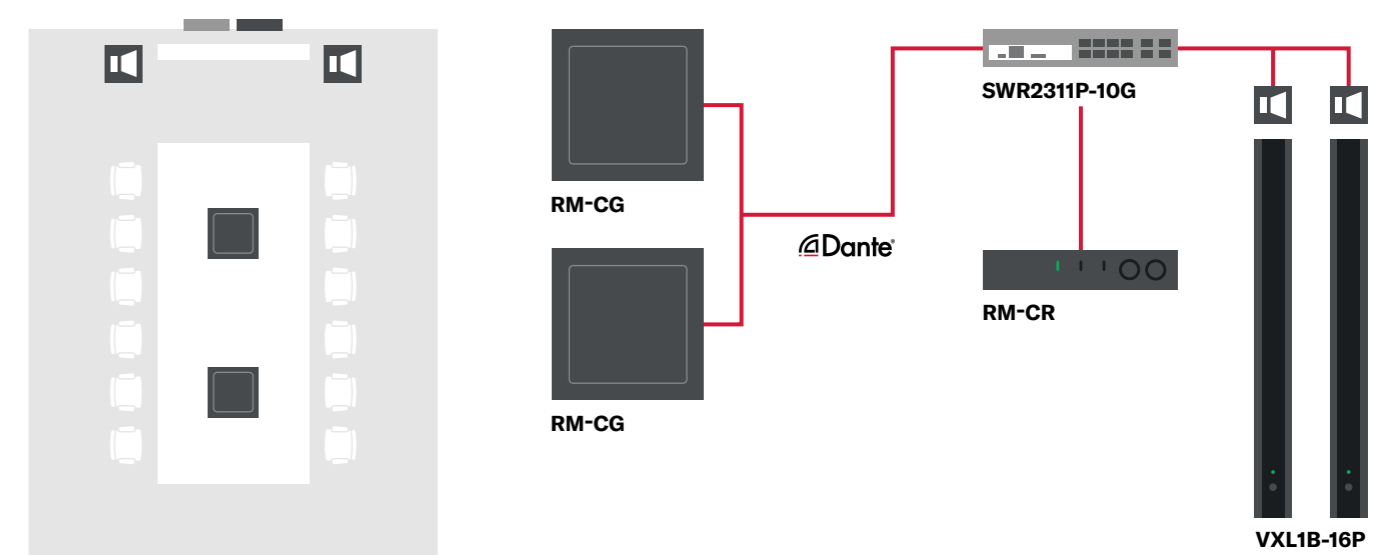

Customization

System Example

The new Yamaha components (Ceiling Array Microphone RM-CG and Remote Conference Processor RM-CR) can also be integrated with other Yamaha or third party components for required solutions with the open interface.

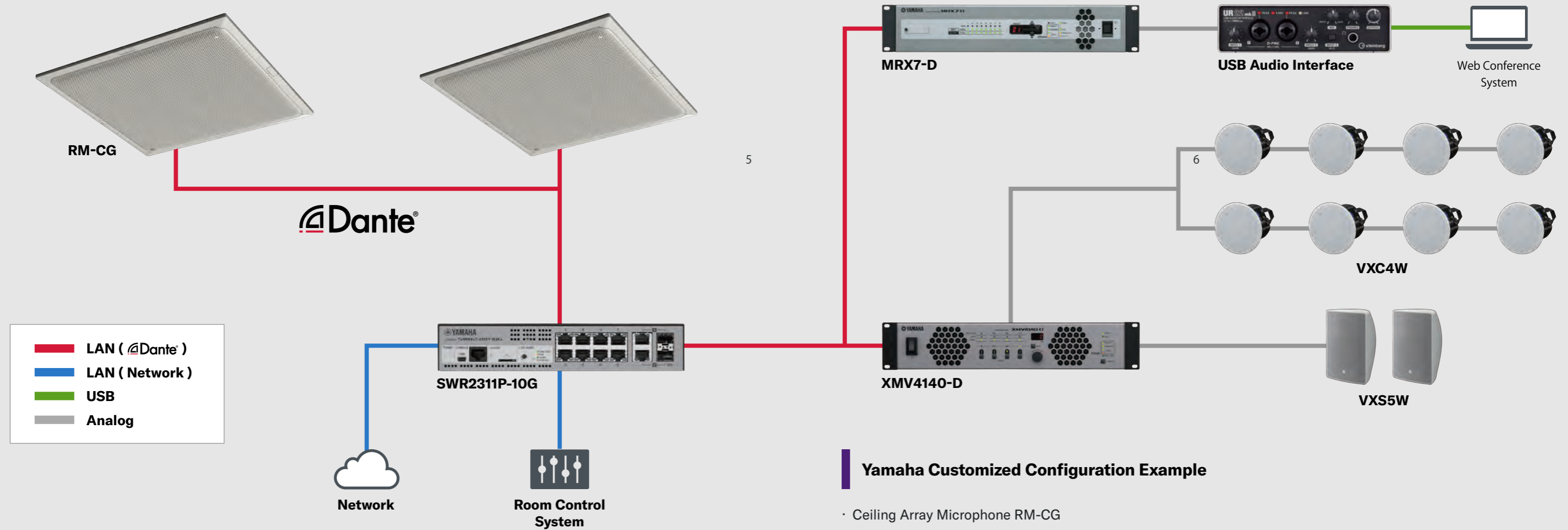

Customization Options

- Expand the number of microphone connections
- Expand peripheral devices/systems (amplifiers/speakers)

Yamaha Customized Configuration Example

- Ceiling Array Microphone RM-CG
- Intelligent L2 Network Switch with PoE SWR2311P-10G
- Signal Processor MRX7-D
- Power Amplifier XMV4140-D
- Ceiling Speaker VXC4W
- Speaker System VXS5W
- USB Audio Interface

Ceiling Array Microphone RM-CG



Ceiling Array Microphone
RM-CG

A ceiling array microphone equipped with unique audio signal processing technology that enables high-quality communication

- Standard network audio support for “Dante”
- “Dynamic Voice Tracking” that scans for human voice
- Four “Auto Tracking Beams” track simultaneous speech allowing for lively conversations
- Utilizes innovative Yamaha technologies like Adaptive Echo Canceller, Automatic Gain Control, Noise Reduction, and Dereverberation
- Automatic detection and configuration with Remote Conference Processor RM-CR
- Utilizes one PoE+ network cable connection avoiding troublesome wiring and enabling audio control via Dante
- Supports 3 types of mounting methods for use with a variety of ceiling conditions

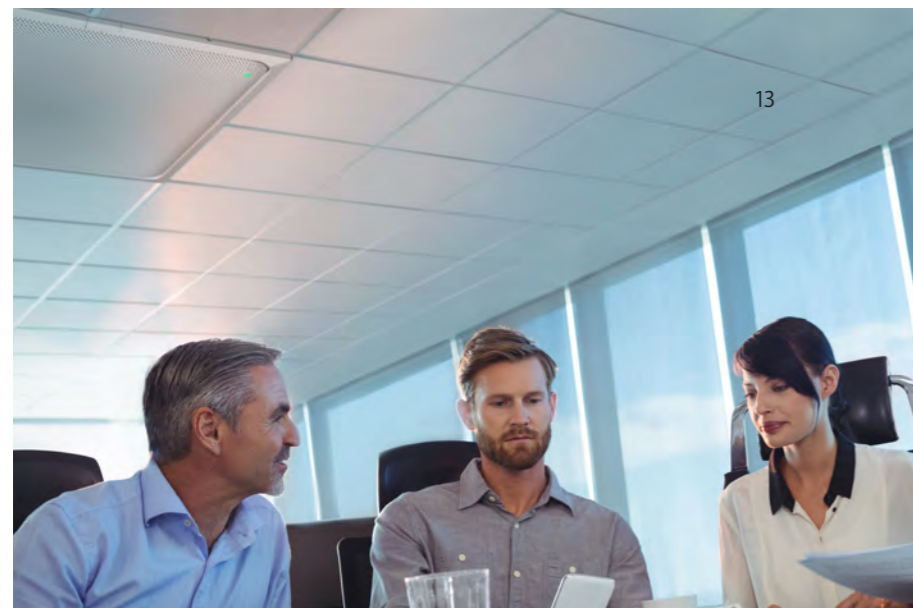

Frequency Response

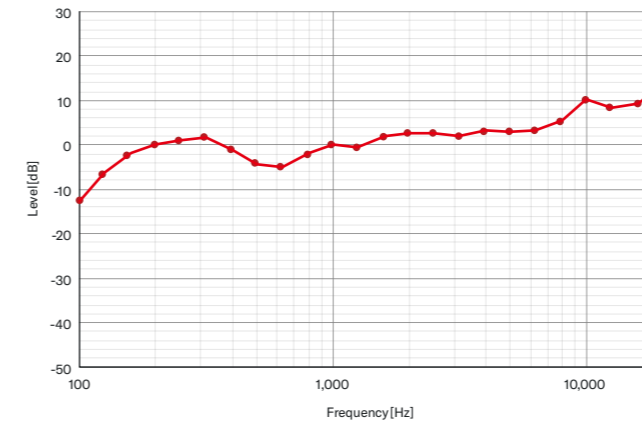

Directional Characteristics

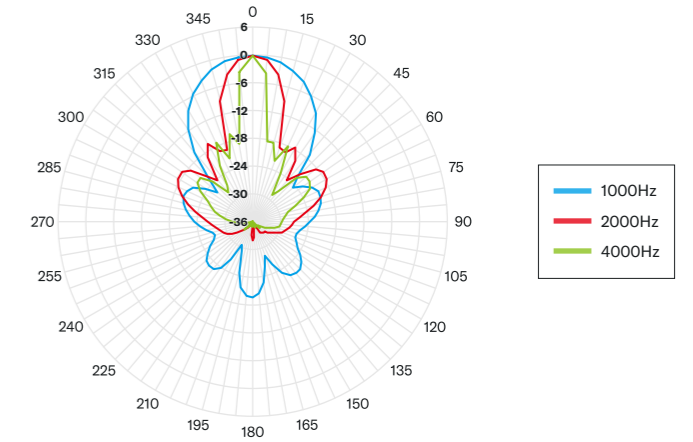

External View

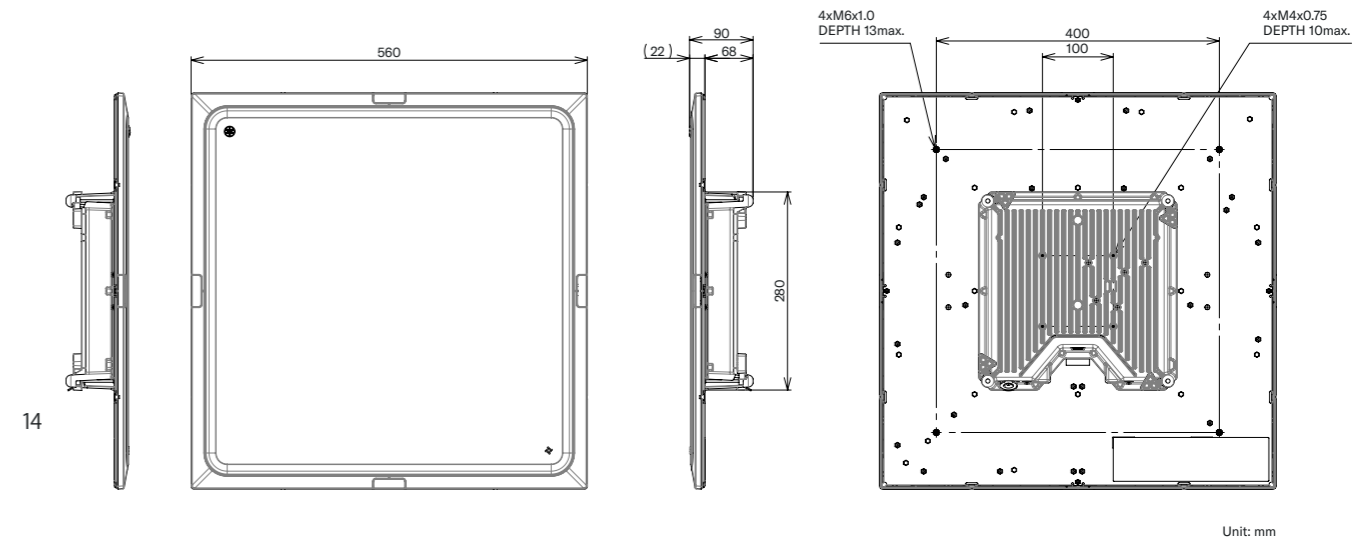

Main Specifications

Audio I/O	Dante 1in/2out
Sampling Rate	48kHz
Bit Depth	24bit
Frequency Response	160Hz - 16kHz (-10dB)
Power Requirements	PoE (IEEE 802.3af), DC 48V
Network	Dante Audio/Dante Control, Remote Control, Web UI, PoE
Latency	56ms (including DSP)
Sensitivity	-23.8dBFS/Pa

SN Ratio	94.8dB
Microphone Beam	4 (Auto Tracking)
Mount	Ceiling mount, Wire mount, Pole mount
Color	White/Black
Dimensions	W560mm x D560mm x H90mm (includes protrusion/microphone panel: 22mm)
Weight	5.6kg

Remote Conference Processor RM-CR



Remote Conference Processor

RM-CR

Signal processor at the heart of the RM series

- Standard network audio support for “Dante”; all compatible devices can be connected with single network cable
- Up to 2 RM-CG and 2 VXL1B-16P can be connected via PoE switch SWR2311P-10G
- Automatically recognizes connected devices on the same network for audio routing
- Equipped with the Auto Tuning functions that automatically measure and provide the optimum sound settings for the environment
- Equipped with the Auto Mixer functions that automatically mix the audio of all connected microphones
- Equipped with various input/output connections such as USB, VoIP, analog, and Bluetooth



Connections

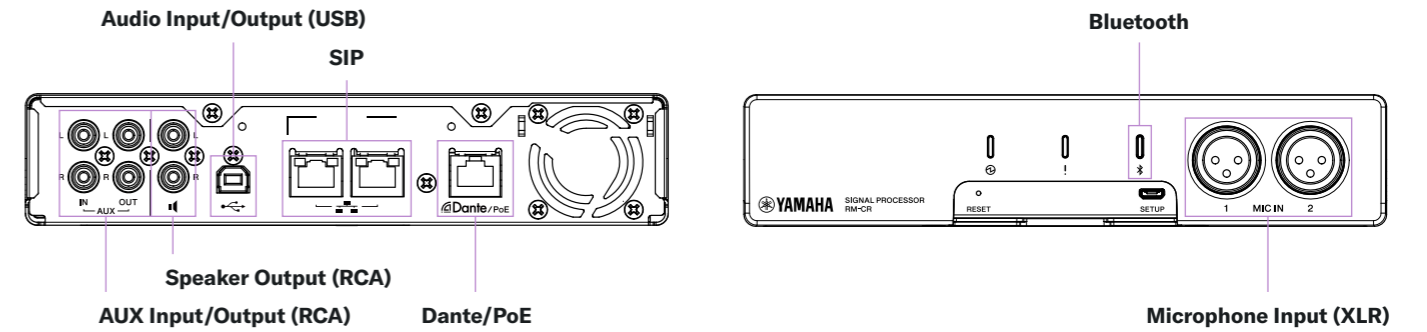

External View

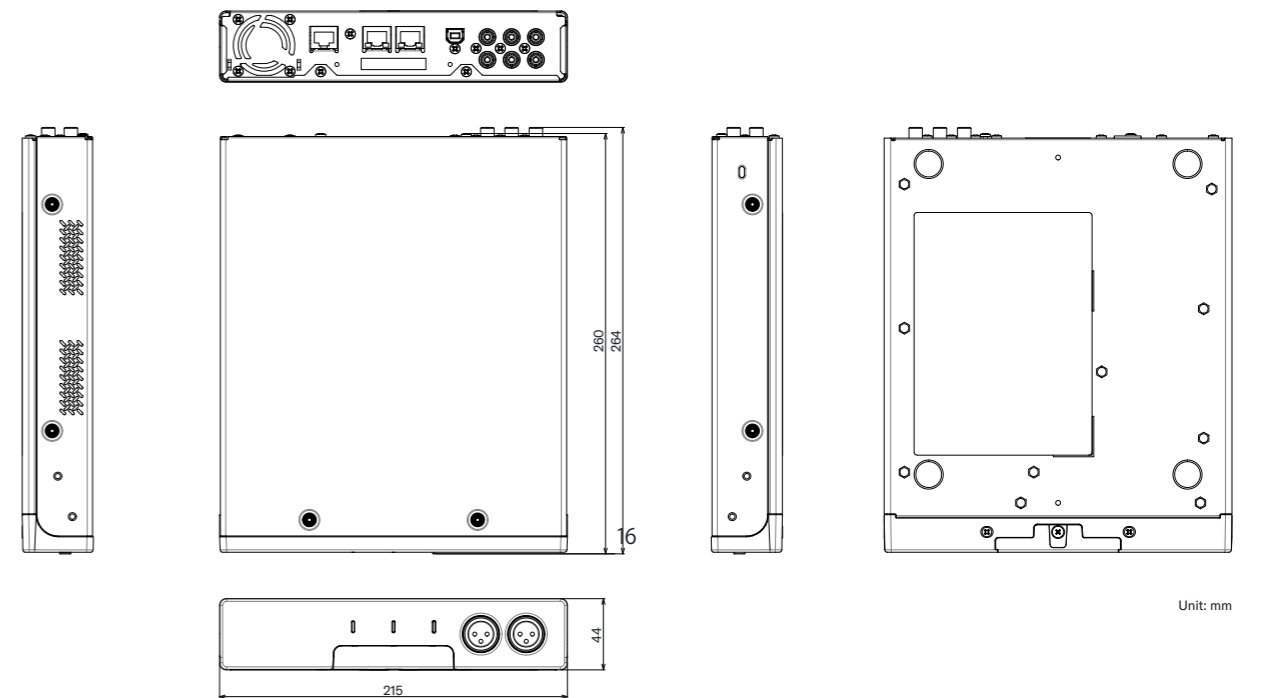

15

Main Specifications

Audio I/O	Dante 16in/16out
	USB 2.0 (type-B)
	RCA unbalanced (Line Level), Input: 2ch, Output: 2ch
	XLR balanced, Input 2ch
	RCA unbalanced (Line Level), Output: 2ch
	SIP
	Bluetooth

Sampling Rate	48kHz
Bit Depth	24bit
Frequency Response	20Hz - 20kHz
Power Requirements	PoE+ (IEEE 802.3at, LLDP), DC 48V
Network	Dante Audio/Dante Control, Remote Control, Web UI, PoE+
Mount	Rack mount, Table mount (optional accessory)
Dimensions	W215mm x D260mm x H44mm
Weight	1.6kg

Specifications

RM-CG Specifications

General	Dimensions (W x D x H)		560mm x 560mm x 90mm (includes protrusion/microphone panel: 22mm)
	Weight		5.6kg
	Power Requirements		PoE (IEEE 802.3af), DC 48V
	Maximum Power Consumption		7.2W
	Connector		RJ45
	In Operation	Temperature	0°C - 40°C
		Humidity	30% - 90% (no condensation)
	Storage	Temperature	-20°C - 60°C
		Humidity	20% - 90% (no condensation)
	Indicator		Front indicator (Mute/Unmute & Status), Network port indicator
	Mount		Ceiling mount, Wire mount, Pole mount
	Maximum Device Number with RM-CR		2
Accessories * Including 1 spare		Installation manual, Warranty card, grill x 1, Grill fixing screw (M3 x 8mm) x5*, Screw cover x 4, Drilling pattern x 1, C ring x 1, C ring fixing screw x 2, U-shaped bracket x 1, U-shaped bracket fixing screw (M4 x 20mm) x 5*, Terminal cover x 1, Safety wire x 1, Cable tie x 1, Temporary retaining bracket x 2	
Dust Protection		IP5X equivalent (when using junction cover)	
Plenum Rating		UL2043 (with junction cover)	

Network	Ether		Dante Audio/Dante Control, Remote Control, Web UI, PoE+
	Cable Requirements		Cat 5e or higher (STP recommended)
	Audio I/O	Dante	1in/2out
	Sampling Rate		48kHz
Audio	Bit Depth		24bit
	Latency		56ms (including DSP)
	Frequency Response		160Hz - 16kHz (-10dB)
	Maximum Input Level of SPL (OdBFS)		117.8dB SPL
	Self Noise		-0.8dBA SPL
	SN Ratio (Ref. 94dB SPL at 1kHz)		94.8dB
	Sensitivity		-23.8dBFS/Pa
	Dynamic Range		118.6dB
	Signal Processing		Multi Beam Tracking, Adaptive Echo Canceller, Noise Reduction, Dereverberation, Auto Mixer, Automatic Gain Control, User Program EQ, Output Gain

RM-CR Specifications

General	Dimensions (W x D x H)		W215mm x D260mm x H44mm
	Weight		1.6kg
	Power Requirements		PoE+ (IEEE 802.3at, LLDP), DC 48V
	Maximum Power Consumption		15.0W
	In Operation	Temperature	0°C - 40°C
		Humidity	30% - 90% (no condensation)
	Storage	Temperature	-20°C - 60°C
		Humidity	20% - 90% (no condensation)
	Indicator		Power indicator, Status indicator, Bluetooth indicator, Network port indicator x 3
	Accessories		Installation manual, USB Cable (A-B) 5m (16.4ft), USB Cable (A-microB) 1m (3.3ft), Rubber foot x 4, Access panel
	Options		Rack Mount Kit RM-MTL, Table Mount Kit RM-MRK
	General	Ether1	
Ether2/Ether3		Corporate Network, Remote Control, SIP, Web UI	
USB		USB2.0, Network Class, Web UI, Fixed IP	
Audio		Audio I/O	Dante
	USB		USB2.0, Audio Class 1.0, Input: 2ch, Output: 2ch @48kHz
	Microphone Input		XLR balanced, Input: 2ch
	AUX		RCA unbalanced (Line Level), Input: 2ch, Output: 2ch
	Speaker Out		RCA unbalanced (Line Level), Output: 2ch

Audio	Bluetooth	Version 4.2
		Supported Profiles: HFP (1.6), A2DP, AVRCP
		Supported Codec: CVSD, SBC, mSBC
		Wireless Output: Class2
		Maximum Communication Distance: 10m (32.8ft) (no obstacles)
	SIP	Radio Frequency (Operational Frequency): 2,402MHz - 2,480MHz
		Maximum Output Power (EIRP): 4.0dBm (2.5mW)
		Call Handling: Dial, Answer, Hold, Resume, Forwarding, Do not disturb, Redial, Call timer, Call ID, Voice mail notifications (switch configured)
		Call Bridging: Supports bridging SIP, USB, BT and AUX calls. Join, Split, Hold, Resume, 5+1 lines: up to 2 SIP calls, 1 USB call, 1 Bluetooth call, 1 AUX, Plus the user
		Codecs: G.711, G.722HD, G.729ab, G.726
DTMF Support: RTP event, SIP in-band, SIP info package		
Security: SRTP support (RFC 1889), IETF SIP support (RFC 3261 and companion RFCs)		
Sampling Rate		48kHz
Bit Depth		24bit
Latency		7ms (Dante In to USB Out, includes signal processing)
Frequency Response		20Hz - 20kHz

RM-CR Analog Input Characteristics

Input Terminal	Input Level		Connector
	Nominal	Max. before Clip	
MIC IN 1,2	-46dBu	-26dBu	XLR-3-31 (Balanced)
AUX IN L,R	-14dBV	+6dBV	RCA Pin

RM-CR Analog Output Characteristics

Output Terminal	Source Impedance	For Use with Nominal	Output Level Connector		Connector
			Nominal	Max. before Clip	
AUX OUT L,R	1kΩ	10kΩ	-14dBV	+6dBV	RCA Pin
SP OUT L,R	1kΩ	10kΩ	-14dBV	+6dBV	RCA Pin

Options



Rack Mount Kit **RM-MRK**

Mount kit for mounting the Remote Conference Processor "RM-CR" in a rack.



Table Mount Kit **RM-MTL**

Mount kit for mounting the Remote Conference Processor "RM-CR" on the table (back side).



Intelligent L2 Network Switch with PoE

SWR231P-10G

An intelligent L2 switch that has the optimal functions for Dante and can supply PoE to devices on the network.



Dante PoE Powered Speaker System

VXL1B-16P/VXL1W-16P

A Dante powered speaker by PoE power supply.



YAMAHA CORPORATION

Yamaha Corporation. All rights reserved.
Product features and specifications are subject to change without notice by Yamaha.
All other product and company names and logos that appear in this leaflet are trademarks or registered trademarks of their respective owners.

BR-ADECIA-SOLUTION-20200901-EN